

BK PRECISION®

Model: 4075, 4078

25 MHz Arbitrary Function Generator

USER MANUAL



SERVICE INFORMATION

Warranty Service: Please go the support and service section on our website www.bkprecision.com to obtain a RMA #. Return the product in the original packaging with proof of purchase to the address below. Clearly state on the RMA the performance problem and return any leads, probes, connectors and accessories that you are using with the device.

Non-Warranty Service: Please go the support and service section on our website www.bkprecision.com to obtain a RMA #. Return the product in the original packaging to the address below. Clearly state on the RMA the performance problem and return any leads, probes, connectors and accessories that you are using with the device. Customers not on an open account must include payment in the form of a money order or credit card. For the most current repair charges please refer to the service and support section on our website.

Return all merchandise to B&K Precision Corp. with pre-paid shipping. The flat-rate repair charge for Non-Warranty Service does not include return shipping. Return shipping to locations in North America is included for Warranty Service. For overnight shipments and non-North American shipping fees please contact B&K Precision Corp.

B&K Precision Corp.
22820 Savi Ranch Parkway
Yorba Linda, CA 92887
www.bkprecision.com
714-921-9095

Include with the returned instrument your complete return shipping address, contact name, phone number and description of problem.

LIMITED THREE-YEAR WARRANTY

B&K Precision Corp. warrants to the original purchaser that its products and the component parts thereof, will be free from defects in workmanship and materials for a period of three years from date of purchase.

B&K Precision Corp. will, without charge, repair or replace, at its option, defective product or component parts. Returned product must be accompanied by proof of the purchase date in the form of a sales receipt.

To obtain warranty coverage in the U.S.A., this product must be registered by completing a warranty registration form on our website www.bkprecision.com within fifteen (15) days of purchase.

Exclusions: This warranty does not apply in the event of misuse or abuse of the product or as a result of unauthorized alterations or repairs. The warranty is void if the serial number is altered, defaced or removed.

B&K Precision Corp. shall not be liable for any consequential damages, including without limitation damages resulting from loss of use. Some states do not allow limitations of incidental or consequential damages. So the above limitation or exclusion may not apply to you.

This warranty gives you specific rights and you may have other rights, which vary from state-to-state.

B&K Precision Corp.
22820 Savi Ranch Parkway
Yorba Linda, CA 92887
www.bkprecision.com
714-921-9095

Safety Summary

The following safety precautions apply to both operating and maintenance personnel and must be observed during all phases of operation, service, and repair of this instrument. Before applying power, follow the installation instructions and become familiar with the operating instructions for this instrument.

Failure to comply with these precautions or with specific warnings elsewhere in this manual violates safety standards of design, manufacture, and intended use of the instrument. B&K PRECISION assumes no liability for a customer's failure to comply with these requirements. This is a Safety Class I instrument.

GROUND THE INSTRUMENT

To minimize shock hazard, the instrument chassis and cabinet must be connected to an electrical ground. This instrument is grounded through the ground conductor of the supplied, three-conductor ac power cable. The power cable must be plugged into an approved three-conductor electrical outlet. Do not alter the ground connection. Without the protective ground connection, all accessible conductive parts (including control knobs) can render an electric shock. The power jack and mating plug of the power cable meet IEC safety standards.

DO NOT OPERATE IN AN EXPLOSIVE ATMOSPHERE

Do not operate the instrument in the presence of flammable gases or fumes. Operation of any electrical instrument in such an environment constitutes a definite safety hazard.

KEEP AWAY FROM LIVE CIRCUITS

Instrument covers must not be removed by operating personnel. Component replacement and internal adjustments must be made by qualified maintenance personnel. Disconnect the power cord before removing the instrument covers and replacing components. Under certain conditions, even with the power cable removed, dangerous voltages may exist. To avoid injuries, always disconnect power and discharge circuits before touching them.

DO NOT SERVICE OR ADJUST ALONE

Do not attempt any internal service or adjustment unless another person, capable of rendering first aid and resuscitation, is present.

DO NOT SUBSTITUTE PARTS OR MODIFY THE INSTRUMENT

Do not install substitute parts or perform any unauthorized modifications to this instrument. Return the instrument to B&K Precision for service and repair to ensure that safety features are maintained.

WARNINGS AND CAUTIONS

WARNING and **CAUTION** statements, such as the following examples, denote a hazard and appear throughout this manual. Follow all instructions contained in these statements.

A **WARNING** statement calls attention to an operating procedure, practice, or condition, which, if not followed correctly, could result in injury or death to personnel.

A **CAUTION** statement calls attention to an operating procedure, practice, or condition, which, if not followed correctly, could result in damage to or destruction of part or all of the product.

WARNING: *Do not alter the ground connection. Without the protective ground connection, all accessible conductive parts (including control knobs) can render an electric shock. The power jack and mating plug of the power cable meet IEC safety standards.*

WARNING: *To avoid electrical shock hazard, disconnect power cord before removing covers. Refer servicing to qualified personnel.*

CAUTION: *Before connecting the line cord to the AC mains, check the rear panel AC line voltage indicator. Applying a line voltage other than the indicated voltage can destroy the AC line fuses. For continued fire protection, replace fuses only with those of the specified voltage and current ratings.*

CAUTION: *This product uses components which can be damaged by electro-static discharge (ESD). To avoid damage, be sure to follow proper procedures for handling, storing and transporting parts and subassemblies which contain ESD-sensitive components.*

Table of Contents

Safety Summary	3
Section 1	1
Introduction	1
1.1 Introduction	1
1.2 Description	1
1.3 Memory Architecture	1
1.4 Package Contents	2
Specifications.....	2
Modulation Combinations.....	4
Section 2	5
Installation.....	5
2.1 Introduction	5
2.2 Mechanical Inspection	5
2.3 Initial Inspection	5
2.4 Instrument Mounting	5
2.5 Product Dimensions	5
2.6 Power Requirements	5
2.7 Grounding Requirements	6
2.8 Signal Connections.....	6
2.9 RS-232 Connection	6
2.10 RS-232 Configuration	7
2.11 GPIB Address.....	7
2.12 GPIB Connections (Optional)	7
Section 3	9
Operating Instructions	9
3.1 General Description	9
3.2 Display Window	10
3.3 Front Panel Controls.....	11
3.4 Back Panel Controls	11
3.5 Output connectors	12
3.6 MENU Keys	12
3.7 ON Key	28
3.8 Cursor Movement Keys	28
3.9 Rotary Input Knob.....	28
3.10 Power-On Settings	28
3.11 Memory.....	29
3.12 Displaying Errors	29
3.13 Using Model 4075 and 4078.....	30
3.14 Examples	30
Section 4	34
Programming.....	34
4.1 Overview	34
4.2 Device State	35
4.3 Interface Function Subsets.....	35
4.4 Device Address.....	35

4.5 Message Exchange Protocol.....	36
4.6 Block Data (GPIB Only).....	37
4.7 Instrument Identification	37
4.8 Instrument Reset	37
4.9 Self Test.....	37
4.10 Command Syntax	37
4.11 Status Reporting	41
4.12 Common Commands.....	45
4.13 Instrument Control Commands.....	49
4.14 IEEE 488.1 Interface Messages	77
4.15 SCPI Command Tree	77
4.16 Block Transfer (GPIB only).....	82
4.17 GPIB Communication Protocol.....	83

Section 5 87

Performance Check Procedures..... 87

5.1 Introduction.....	87
5.2 Test Equipment.....	87
5.3 Performance Tests	88

Section 1

Introduction

1.1 Introduction

This manual contains information required to operate, program and test the Model 4075 and 4078 – 25 MHz DDS Arbitrary Function Generators. This section covers the instrument general description, instrument specifications and characteristics.

1.2 Description

The Model 4075 and 4078 are versatile high performance arbitrary waveform generators. Arbitrary waveforms can be programmed and generated with 14 bit resolution and up to 400,000 points length. Waveforms can be output in continuous, triggered, gated or burst mode. AM and FM modulation combined with versatile Sweep capabilities make the unit suitable for a wide range of applications. Editing is flexible and easy including auto increment, line draw and predefined waveform facilities. The instrument can be remotely operated via the RS232 or an optional GPIB interface (order models 4075GPIB or 4078GPIB) and they are SCPI compatible.

1.3 Memory Architecture

The waveform memory consists of 400,000 points. The user can edit arbitrary waveforms in waveform memory and can specify any data value in the range from -8191 to 8191 for any point in waveform memory (14 bit depth). Due to their large memory bank, the 4075 and 4078 can essentially give the user greater freedom in selecting the size of their waveforms and the number of waves they desire to generate, with the limit of 400,000 total points when added together.

For example, these generators can create a waveform with 10,000 points, another waveform with 50,000 points, a third waveform with 40,000 points, and a fourth waveform with 300,000 points. These four waveforms total up to 400,000 points, but essentially they can be referenced in the memory bank according to their starting point and their length. There are no restrictions as to how many different waveforms you can store in the memory, so as long as the sum of the points of all the waveforms do not exceed 400,000 points. To better illustrate this, refer to drawing below:

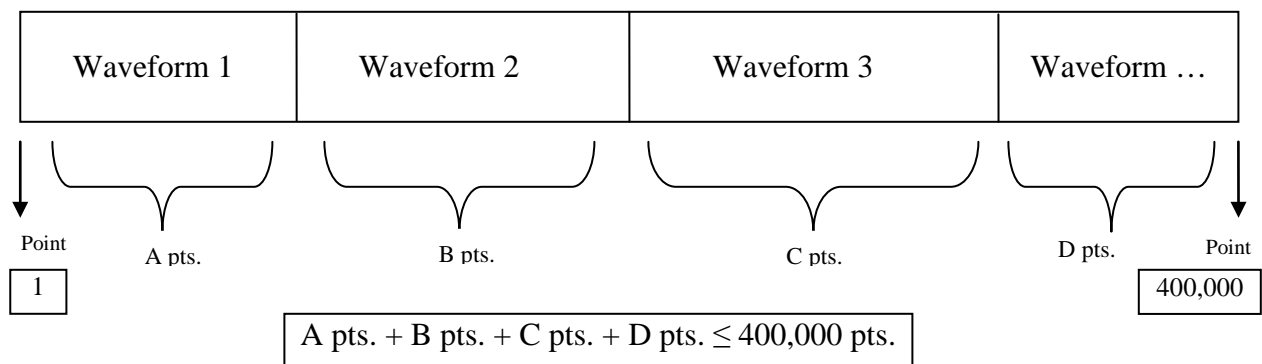

The following operations can be performed in the waveform memory:

- Insert and scale any of the following predefined waveforms:
 - o Sine
 - o Triangle
 - o Square
 - o Ramp up

- Ramp down
- Noise

- Draw a line between any two points
- Clear (set to zero) any set of points or all points
- Set individual point values

After specifying a section of waveform memory for execution, the following parameters of the waveform can be configured:

- Point rate (frequency)
- Peak-to-peak amplitude
- Offset voltage

1.4 Package Contents

The following list of items and accessories come in the package:

1. 4075 or 4078 DDS Function Generator
2. AC power cord
3. CD containing user manual and waveform creation software Wave-X
4. RS232 Serial Cable

Specifications

Models		4075	4078
Channels		1 Channel	2 Channels
Frequency Characteristics	Sine	1 uHz to 25 MHz	
	Square	1 uHz to 25 MHz	
	Triangle, Ramp	1 uHz to 5 MHz	
	Pulse	1 MHz to 10 MHz	
	Accuracy	0.002 % (20 ppm)	
	Resolution	12 digits or 1 uHz	
Arbitrary Characteristics	Built-in Waveforms	Sine, Triangle, Square, Noise, Ramp Up, Ramp Down, Sine(X)/X, Exponential Up, Exponential Down, Gaussian	
	Waveform Length	2 points to 400,000 points	
	Vertical Resolution	14 bits (16,384 levels)	
	Noise	Add 1% to 100% to output waveform	
	Sampling Rate	100 MSa/s, Point execution rate: adjustable from 10 ns to 50 s	
	Frequency Accuracy	0.005% (50 ppm)	
	Frequency Resolution	4 digits	
Output Characteristics	Amplitude Range	10 mV to 10 Vp-p into 50 ohms	
	Amplitude Resolution	3 digits (1000 counts)	
	Amplitude Accuracy (at 1 kHz)	± 1% ± 1 mV	
	Flatness (relative to 1 kHz)	± 0.2 dB to 1 MHz ± 1 dB to 25 MHz	
	Offset Range	± 5 V into 50 Ω, depending on the Amplitude setting	
	Offset Resolution	10 mV with 3 digits resolution	
	Offset Accuracy	± 1% ± 10 mV into 50 Ω	
	Output Impedance	50 Ω typical	
Output Protection	The instruments output is protected against short circuit or nominal accidental voltages applied to the main output connector		

	Output Leakage	Approximately 10 mA can be present at the output BNC connector when unit is powered on and the output is off	
Waveform Characteristics	Total Harmonic Distortion (sine)	DC-20 kHz, -65 dBc	
		20 kHz-50 kHz, -60 dBc	
		50 kHz-100 kHz, -50 dBc	
		100 kHz-10 MHz, -45 dBc	
		10 MHz-25 MHz, -35 dBc	
	Spurious (sine)	DC-1 MHz < -60 dBc	
	Rise/Fall Time (square, pulse)	< 12 ns (10% to 90%) at full amplitude into 50 Ω	
	Variable Duty Cycle	20% to 80% to 5 MHz (square) 40% to 60% to 10 MHz (square) 50% >10 MHz (square))	
	Variable Symmetry	10%-90% to 5 MHz (triangle)	
	Symmetry at 50%	< 1 % + 5 ns	
	Linearity (triangle, ramp)	<0.1% of peak output (1 μHz to 250 kHz)	
Pulse Width (period 10 μs - 0.1 μs)	20 ns to < (Period -20 ns) (10 ns resolution)		
Variable Edge Time (period 100 μs - 0.16 μs)	100 ns to Width/0.625 (50 % duty cycle) 10 ns resolution		
Operating Modes	Continuous	Output continuous at programmed parameters	
	Triggered	Output quiescent until triggered by an internal or external trigger, then one waveform cycle is generated to programmed parameters. Up to 10 MHz trigger rate for ARB waveforms and 5 MHz in DDS mode	
	Gate	Same as triggered mode, except waveform is executed for the duration of the gate signal. The last cycle started is completed	
	Burst	2-999,999 cycles	
	Phase	-360.0 to +360 degrees with 0.1 degree resolution	
	Trigger Source	Trigger source may be internal, external or manual. Internal trigger rate 0.01 Hz-1 MHz (1 μs – 100 s)	
Modulation Characteristics	Amplitude Modulation	Internal	0.1 Hz-20 kHz sine , square or triangle waveform variable modulation from 0% to 100%
		External	5 Vp-p for 100% modulation, 10 kΩ input impedance 0.01 Hz - 50 KHz bandwidth
	Frequency Modulation	Internal	0.1 Hz-20 kHz sine wave, square or triangle
		External	5 Vp-p for 100% deviation, 10 kΩ input impedance, 0.01 Hz – 50 kHz bandwidth
Sweep Characteristics	Sweep Shape	Linear and Logarithmic, up or down	
	Sweep Time	20 ms to 500 s	
	Sweep Trigger	internal, external, continuous or burst	
Inputs and Outputs	Trigger IN	TTL Compatible Maximum rate 10 MHz in ARB mode, 3 MHz in DDS mode Minimum width 50ns	
	Sync OUT	TTL pulse at programmed frequency, 50ohms source impedance	
	Modulation IN	5 Vp-p for 100% modulation 10 KΩ input impedance DC to >50 kHz minimum bandwidth	
	Marker Out	Positive TTL pulse user programmable in Arbitrary waveform, 50 Ω source impedance	
	Reference IN-OUT	10 MHz, TTL compatible, input or output, for external unit synchronization 50 Ω output impedance and 1 kΩ input	

Internal Trigger	Repetition	1 μ s to 100 s	
	Resolution	4 digits	
	Accuracy	\pm 0.002%	
General	Store Memory	50 full panel settings at power-off	
	Arbitrary Memory	400,000 points in flash memory	
	Dimensions	8.4(213) x 3.5(88) x 12(300) inches (mm) (WxHxD)	
	Weight	Approx. 3 kg	
	Power	100 VAC-240 VAC \pm 10%, 50 VA max.	
	Temperature	Operating	0 °C to +50 °C
		Non-operating	-20 °C to +70 °C
	Humidity	95 % RH , 0 °C to 30 °C	
	EMC	According to EN55011 for radiated and conducted emissions	
	Electrical Discharge Immunity	According to EN55082	
Safety Specifications	According to EN61010 , CE approved		

NOTE

Specifications listed in manual are applicable after a powered 30 minute warm-up
Specifications are verified according to the performance check procedures.
Specifications not verified in the manual are either explanatory notes or general performance characteristics only.
Specifications and information is subject to change without notice. For the most current and correct data please visit www.bkprecision.com

Modulation Combinations

	SINE	SQUARE	TRIANGLE	ARBITRARY
AM	Yes	Yes	Yes	Yes
FM	Yes	Yes	Yes	No
FSK	Yes	Yes	Yes	No

Section 2

Installation

2.1 Introduction

This section contains installation information, power requirements, initial inspection and signal connections for Model 4075 and 4078.

2.2 Mechanical Inspection

This instrument was carefully inspected before shipment. Upon receipt inspect the instrument for damage that might have occurred in transit. If there is damage due to shipping, file a claim with the carrier who transported the unit. The shipping and packing material should be saved if reshipment is required. If the original container is not to be used, then use a heavy carton box. Wrap the unit with plastic and place cardboard strips across the face for protection. Use packing material around all sides of the container and seal it with tape bands. Mark the box "FRAGILE".

2.3 Initial Inspection

After the mechanical inspection, verify the contents of the shipment (accessories and installed options). If the contents are incomplete, or if the instrument does not pass the specification acceptance tests, notify the local service center.

2.4 Instrument Mounting

The Model 4075 and 4078 - Function Generators are intended for bench use. The instrument includes a front feet tilt mechanism for optimum panel viewing angle. The instrument does not require special cooling when operated within conventional temperature limits. The unit can be installed in a closed rack or test station if proper air flow is assured for removing about 15 W of power dissipation.

2.5 Product Dimensions

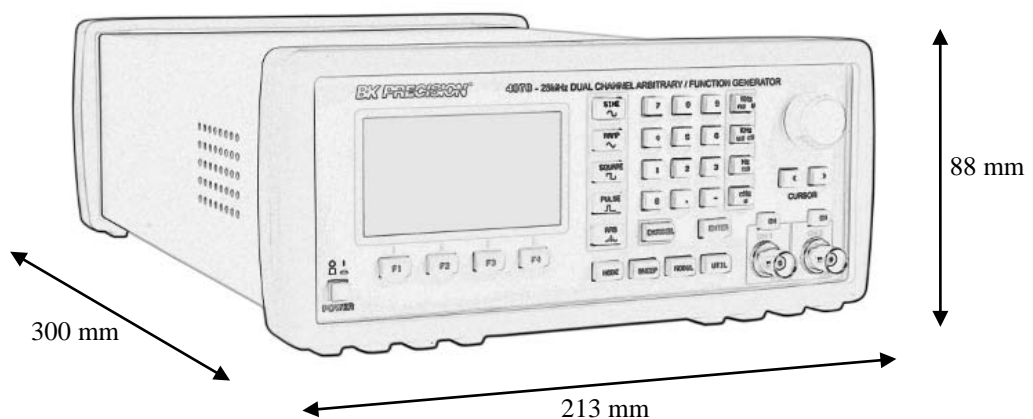

2.6 Power Requirements

The Model 4075 and 4078 can be operated from any source of 90 V to 264 V AC, frequency from 48 Hz to 66 Hz. The maximum power consumption is 50 VA. Use a slow blow fuse UL/CSA approved of 1 A as indicated on the rear

panel of the instrument.

The instrument power fuse is located in the AC input plug. To access the fuse, first disconnect the power cord and then remove the fuse cartridge.

2.7 Grounding Requirements

For the safety of operating personnel, the instrument must be grounded. The central pin on the AC plug grounds the instrument when properly connected to the ground wire and plugged into proper receptacle.

WARNING

TO AVOID PERSONAL INJURY DUE TO SHOCK, THE THIRD WIRE EARTH GROUND MUST BE CONTINUOUS TO THE POWER OUTLET. BEFORE CONNECTION TO THE POWER OUTLET, EXAMINE ALL CABLES AND CONNECTIONS BETWEEN THE UNIT AND THE FACILITY POWER FOR A CONTINUOUS EARTH GROUND PATH. THE POWER CABLE MUST MEET IEC SAFETY STANDARDS.

2.8 Signal Connections

Use RG58U 50 Ω or equivalent coaxial cables for all input and output signals to and from the instrument.

2.9 RS-232 Connection

The rear panel RS-232 connector is a standard DB-9 male connector configured as a DCE. The pin assignments are defined in the table below:

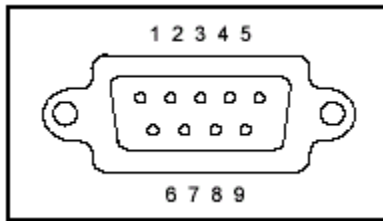

DB-9 pin	Name	Note
1	-	-
2	TXD	Transmit Data
3	RXD	Receive Data
4	-	-
5	GND	Signal ground
6	-	-
7	RTS	Request to Send
8	CRS	Clear to send
9	-	-

**Note: Use a Null-modem or cross over cable (pin 2 and 3 switched) in order to communicate with instrument. When transmitting large files, use only RS232 to RS232 (female to female) cables with no more than 50FT in length. Baudrate of 9600 and 19200 are recommended values when configuring the interface.*

2.9.1 Communication Speed

The 4075 and 4078 have the capabilities of generating large arbitrary waveforms with up to 400,000 points. Due to this nature, the time it takes to transmit these large waveforms may vary depending on the baudrate and cable used for RS232 interface. As a general reference, provided below is a chart that shows the approximate amount of time it takes to download or send the waveforms of the indicated sizes at the rated baudrate speed.

Number of data pts. Baudrates (bps)	10,000 points	64,000 points	100,000 points	400,000 points
9600	~1 min	~3 mins	~9 ½ mins	~40+ mins
19200	~30 secs	~1 min 40 secs	~6 mins 15 secs	~26+ mins

2.10 RS-232 Configuration

The instrument use **8 data bits, 1 stop bit, no parity** and baud rate selectable from 2400 to 19.2K (2400, 4800, 9600, 19200). By default, the instrument is set at **9600-8-N-1**.

When the instrument is in remote mode, it will display the following screen:



This screen comes up whenever there is a transmission process, be it sending or receiving. To return to local mode and exit this screen, simply press any front panel keys. Only do this when nothing is being transmitted or received from a connected PC. In the case where a large waveform is being transmitted, please allow **AT LEAST** 15 seconds or more after the PC software or program has finished sending **BEFORE** pressing a key to return to local mode. The instrument requires this time to completely finish generating/transmitting the waveform.

2.11 GPIB Address

The instrument is shipped with the address set to decimal 9. The address can be changed from the front panel by using the "UTILITY" menu.

2.12 GPIB Connections (Optional)

The rear panel GPIB connector is an AMPHENOL 57-10240 or equivalent, and connects to a standard IEEE-488 bus cable connector. The GPIB line screens are not isolated from chassis and signal ground.

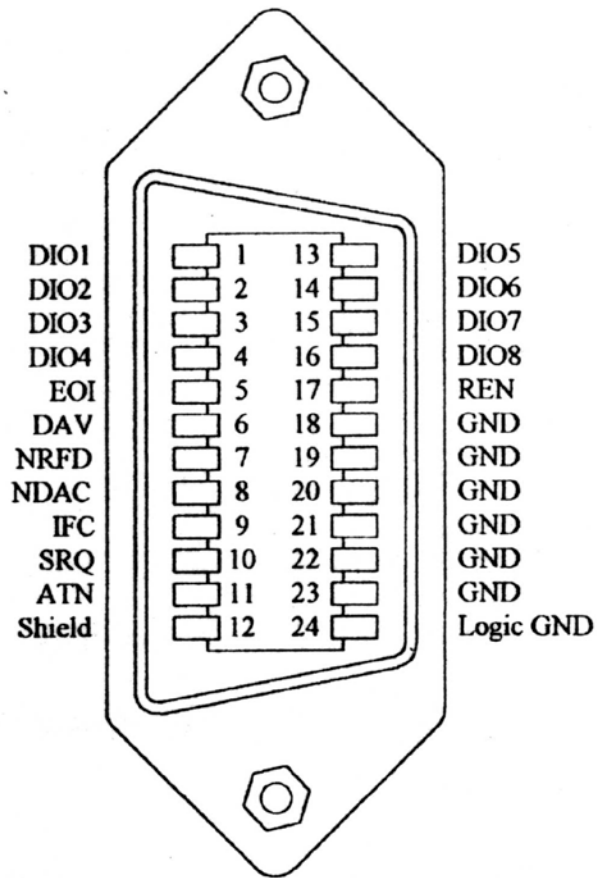

Section 3 Operating Instructions

3.1 General Description

This section describes the displays, controls and connectors of the Model 4075 and 4078 - Function Generators. All controls for the instrument local operation are located on the front panel. The connectors are located on both front and rear panels.

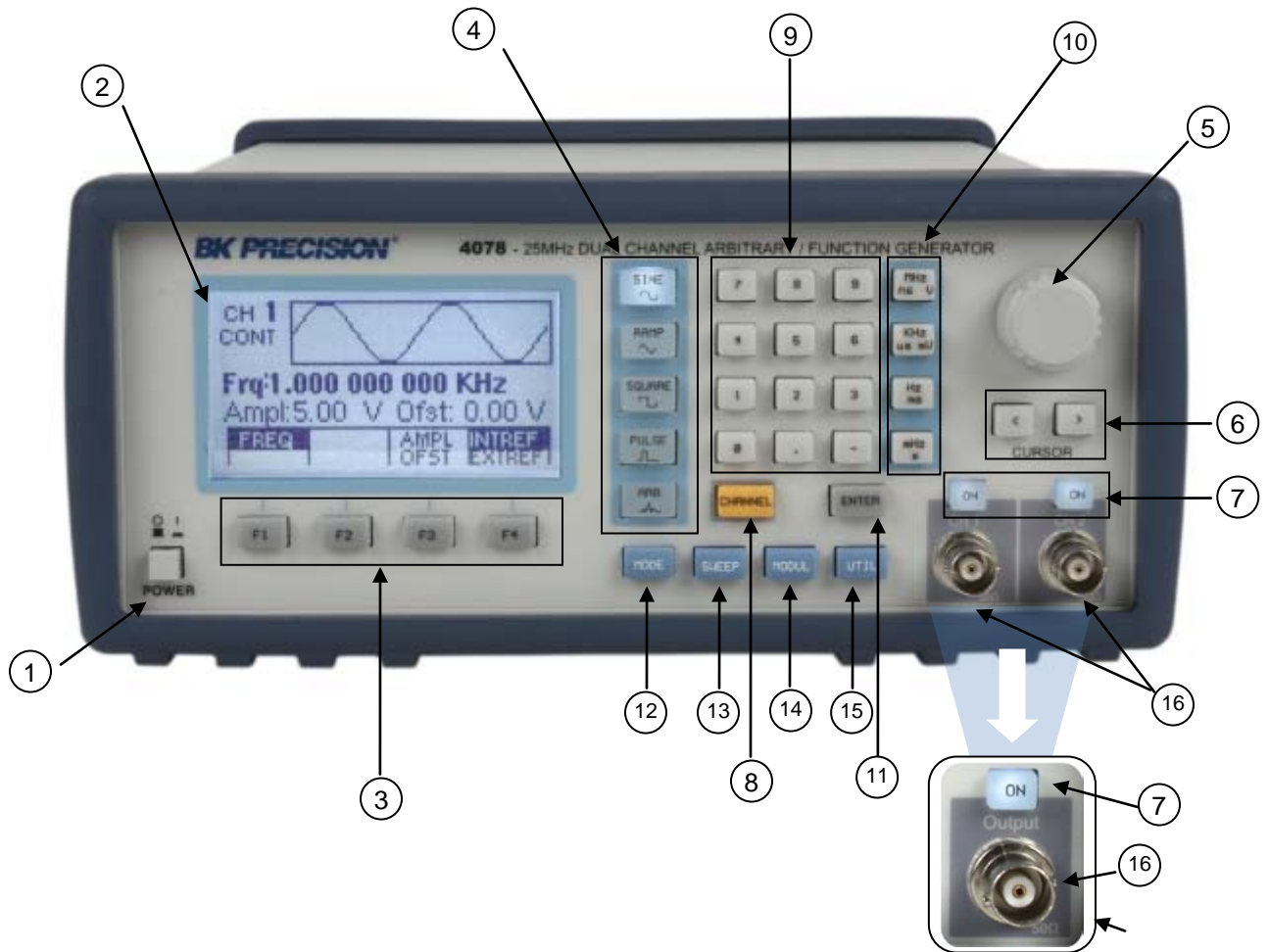

Figure 3.1 - Front Panel View

(for Model 4075)

- | | |
|--|--|
| <ol style="list-style-type: none"> 1. Power ON-OFF 2. Display Window 3. F1-F4 Keys 4. Function Keys 5. Rotary Knob | <ul style="list-style-type: none"> - Applies and removes AC power to the unit - Displays all instrument data and settings on a LCD. - Select the menu options that appear on the second line of the LCD display. Menus differ depending on the selected parameter, function or mode. - Select the output waveform, Sine, Triangle, Square, Pulse or Arbitrary. - Used to increment/decrement numerical values or to scan through the possible selections. |
|--|--|

- 6. **Cursor Keys** - Used to move the cursor (when visible) to either left or right when modifying values of various parameters.
- 7. **Output ON** - Controls the main output signal. The output status is ON when lid.
- 8. **Channel** - Selects the channel to configure (model 4078 only)
- 9. **Numerical Keypad** - Numeric entry keys for entering values for various functions and modes
- 10. **Unit Setting Keys** - Quick keys for setting units for frequency, time, and amplitude
- 11. **Enter Key** - Used for saving settings and numerical values
- 12. **Mode Key** - Select from continuous, triggered burst, gate, or phase mode
- 13. **Sweep Key** - Enters into the sweep menu to configure sweep settings
- 14. **Modul Key** - Enters into the modulation menu for selecting modulation functions
- 15. **Util Key** - Used for remote settings, system setup save/restore, and power settings.
- 16. **Channel Output** - Dual BNC channel outputs (50 Ω) of function signals (model 4075 has CH1 only).

3.2 Display Window

The Model 4075 and 4078 have graphic LCD displays that can display up to 124 x 64 dots. When you power-on the unit the SINE function is selected and its current settings appear in the display. The bottom displays a menu that corresponds to the function, parameter or mode display selected.

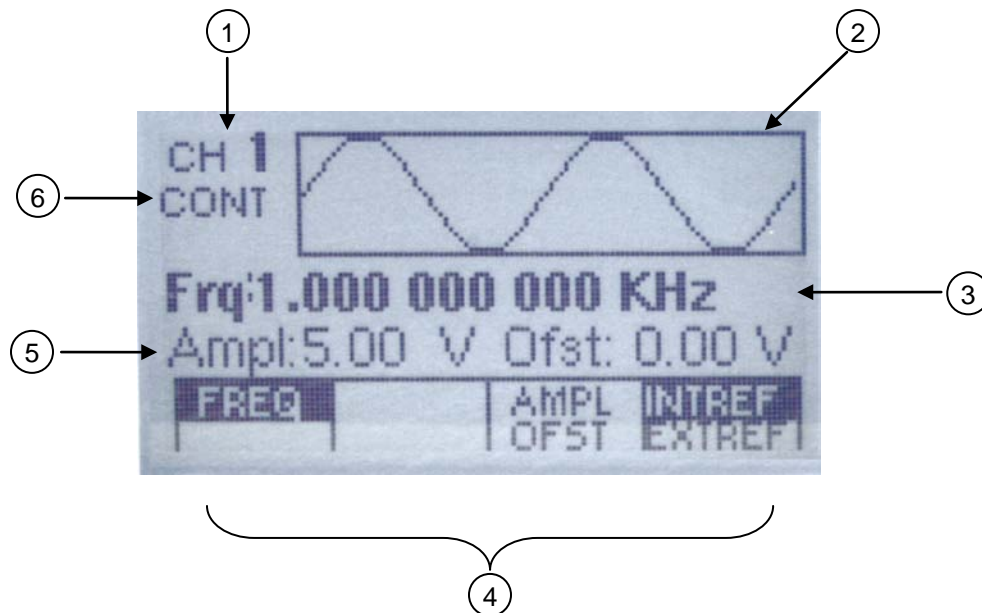

Figure 3.2 - LCD Display Screen

- 1. **Channel Display** - Displays the current selected channel. (For model 4078 only)
- 2. **General Waveform Display** - Displays the general waveform being generated in the channel.
Note: Waveform shown is approximated and scaled down. It does not show the exact representation of the waveform at the output.
- 3. **Frequency/ Sweep Mode Display** - Displays the frequency values currently set to. In sweep mode, it displays the sweeping type (Linear or Logarithmic).
- 4. **Menu Functions Display** - Displays the menu options available. Use F1-F4 keys on front panel to select the options.
- 5. **Menu Parameters Values Display** - Displays the values of parameters selected in the menu. Depending on the options chosen, various parameters will display with a cursor for adjusting their values.

6. Mode Display

- Displays the current mode selected. The can be continuous, trigger, burst, or gate (displayed as CONT , TRI, BURST, or GATE respectively). *Refer to section 3.6.2 for details.*

3.3 Front Panel Controls

The front-panel controls select, display, and change parameter, function, and mode settings. They also include the keys you use to program and generate arbitrary waveform output. *Refer to Figure 3.1.*

Use the rotary input knob and the cursor movement keys to enter data into the waveform generator.

To change a setting:

1. Press any **FUNCTION** keys (F1 – F4) that lead to a required item.
2. Move cursor using **CURSOR** keys to the appropriate position in the numeric field (if applicable).
3. Use the rotary input or the numerical **KEYPAD** to change the value of the displayed item. Changes take effect immediately.
4. In some parameter settings, the **ENTER** key must be pressed in order to set their numerical/setting values. Otherwise, it may not save.

3.4 Back Panel Controls

The function generator has nine (five for model 4075) BNC Connectors on the rear panel where you can connect coaxial cables. These coaxial connectors are labeled accordingly on the back panel for their respective channels and serve as carrier lines for input and output signals delivered to and from the function generator.

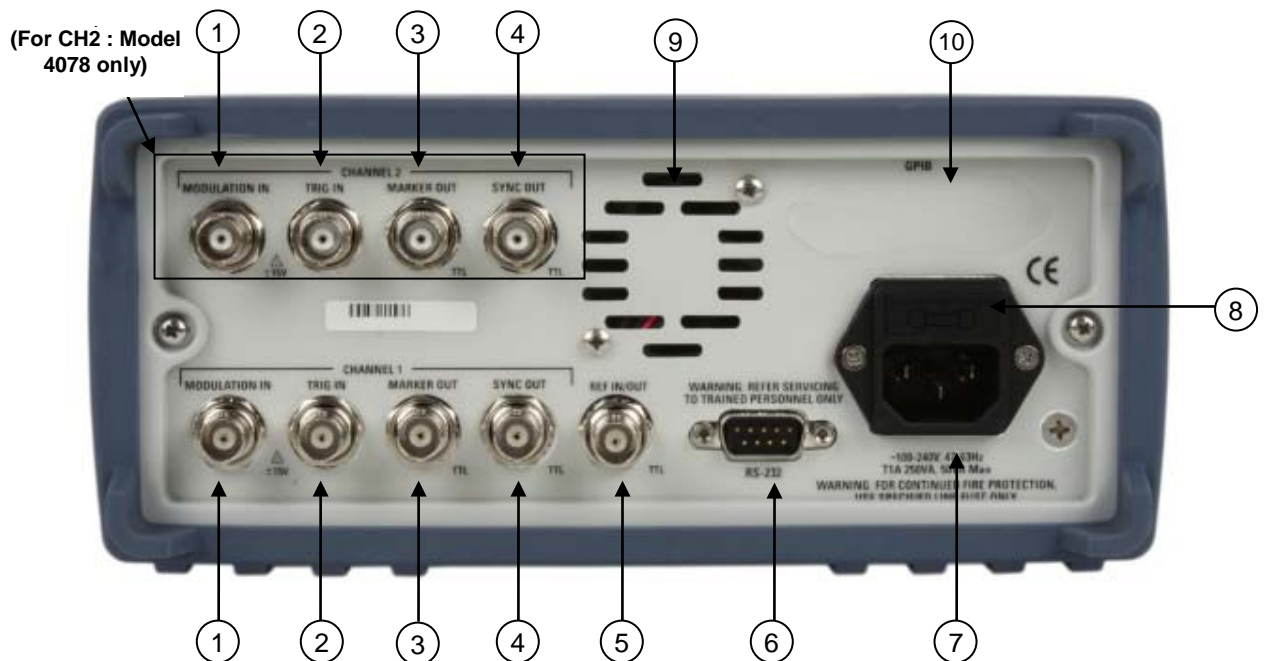

Figure 3.3 - Back Panel View

1. **Modulation In** - 5 Vp-p signal for 100% modulation, 10Kohms input impedance with DC - >20 KHz bandwidth. This connector can be used for modulating external signals in AM and FM modulation.
2. **Trig In** - Use this connector to apply an external trigger or gate signal, depending on the waveform

generator setting, to the generator. This connector is also used when using an external signal to generate FSK under modulation menu. (*See section 3.6.8 for details*)

3. **Marker Out** - Use this connector to output a positive TTL pulse in Arbitrary waveform mode. The Marker position and width can be programmed at any desired Arbitrary locations. (*See section 3.6.3 for details*)
4. **Sync Out** - Use this connector to generate a positive TTL sync pulse output at each waveform cycle.
5. **Ref In/Out** - Use this connector to input a 10 MHz TTL signal to be used as a reference clock for the unit signal generation. A 10MHz TTL level signal is available for synchronization of external units, when not in External Reference mode.
6. **RS-232 Port** - Used to connect to PC via serial cable for RS-232 serial interface and programming.
7. **AC Power Connector** - Used to connect power cable to AC line source.
8. **Fuse Box** - Fuse compartment to check or replace fuse.
9. **Rear Fan** - Rear fan for internal cooling and ventilation. Do not block this area and be sure to leave enough room for air to exhaust.
10. **GPIB Port** - (Optional) For connecting to PC using GPIB interface.

3.5 Output connectors

The waveform generator output circuits is protected against short circuit or nominal accidental voltages applied to the main output connector . It operate as a 50 ohm voltage source working into a 50 ohms load. At higher frequencies, non-terminated or improperly terminated output causes aberrations on the output waveform. In addition, loads less than 50 ohms reduce the waveform amplitude, while loads more than 50 ohms increase waveform amplitude.

Excessive distortion or aberrations caused by improper termination are less noticeable at lower frequencies, especially with sine and triangle waveforms. To ensure waveform integrity, follow these precautions:

1. Use good quality 50 ohms coaxial cables and connectors.
2. Make all connections tight and as short as possible.
3. Use good quality attenuators if it is necessary to reduce waveform amplitudes applied to sensitive circuits.
4. Use termination or impedance-matching devices to avoid reflections.
5. Ensure that attenuators and terminations have adequate power handling capabilities.

If there is a DC voltage across the output load, use a coupling capacitor in series with the load. The time constant of the coupling capacitor and load must be long enough to maintain pulse flatness.

Impedance Matching

If the waveform generator is driving a high impedance, such as the 1 M Ω input impedance (paralleled by a stated capacitance) of an oscilloscope vertical input, connect the transmission line to a 50 Ω attenuator, a 50 Ω termination and to the oscilloscope input. The attenuator isolates the input capacitance of the device and terminates the waveform generator properly.

3.6 MENU Keys

These keys select the main menus for displaying or changing a parameter, function or mode. Below is the hierarchy and selections of the menu tree.

MENU TREE

- SINE
 - o FREQ
 - o AMPL | OFST
 - o INTREF | EXTREF
- RAMP

- FREQ
 - SYM
 - AMPL | OFST
 - INTREF | EXTREF
- SQUARE
 - FREQ
 - SYM
 - AMPL | OFST
 - INTREF | EXTREF
- PULSE
 - FREQ
 - PULSE
 - FREQ | PERIOD
 - WIDTH
 - EQUAL EDGE
 - LEAD | TRAIL
 - AMPL | OFST
 - INTCLK | EXTCLK
- ARB
 - FREQ | RATE
 - ARB
 - START | LENGTH
 - SAVE ARB
 - ABORT
 - MARK
 - ADDR
 - LENGTH
 - ON | OFF
 - PREV
 - EDIT
 - POINT
 - ADRS
 - DATA
 - PREV
 - LINE
 - FROM
 - TO
 - EXEC
 - NO | YES
 - PREV
 - PREDEF
 - TYPE
 - FROM | DATA
 - LENGTH | SCALE
 - EXEC
 - NO | YES
 - MORE
 - COPY
 - FROM
 - LENGTH
 - TO
 - EXEC
 - NO | YES
 - CLEAR
 - FROM
 - TO
 - ALL
 - EXEC
 - NO | YES
 - PROT
 - FROM
 - TO
 - ALL
 - ON | OFF
 - SHOW WAVE
- MODE
 - CONT
 - TRIG BURST
 - MAN
 - INT
 - TRIG RATE
 - EXT

- NBRST
 - GATE
 - MAN
 - INT
 - GATE RATE
 - EXT
 - PHASE (not available in ARB mode)
 - PHASE
 - SET-ZERO
 - PREV
- SWEEP (not available in PULSE and ARB mode)
 - ON | OFF
 - START | STOP
 - RATE
 - LIN | LOG
- MODUL
 - AM
 - ON | OFF
 - % | SHAPE
 - MOD. FREQ
 - EXT | INT
 - FM (not available in PULSE and ARB mode)
 - ON | OFF
 - DEV | SHAPE
 - MOD. FREQ
 - EXT | INT
 - FSK (not available in PULSE and ARB mode)
 - ON | OFF
 - F-HI | F-LO
 - RATE
 - EXT | INT
- UTIL
 - RS232<
 - RECALL | STORE
 - POWER

3.6.1 WAVEFORM Keys

The keys select the waveform output and displays the waveform parameter menu (frequency, amplitude and offset). When the Arbitrary waveform is selected, the display shows also the waveform rate.



Sine Menu

F1: FREQ - (Frequency) Selects and displays the frequency. Change the frequency setting using the cursor keys and rotary knob or numerical keypad. If a certain wavelength can't produce the waveform at the desired frequency, the waveform generator displays an "Out of Range" error message.

F1: FREQ/RATE - Selects and displays the Point Rate (for Arbitrary Waveform mode only). The Rate parameter governs the rate at which waveform points are executed, and thus the frequency of the waveform output will also be affected. When you set this parameter, the waveform generator will keep that execution rate for all waveform lengths until it is changed.

F3: AMPL/OFST - Selects the Amplitude or the Offset parameters.

In Arbitrary mode this setting defines the maximum peak-to-peak amplitude of a full-scale waveform. If the waveform does not use the full scale of data (-8191 to +8191), then its actual amplitude will be smaller.

Setting the Amplitude

The following equation represents the relative output amplitude voltage relationship between the front-panel amplitude peak-to-peak setting and the data point values in waveform memory:

$$output\ voltage = \frac{Amplitude\ p - p\ setting \cdot data\ point\ s\ value}{16382} + offset$$

Where 16382 is the total data point value range in waveform memory.

Examples

Front Panel Amplitude Setting	Data Point Value	Relative Output Amplitude Voltage
5 Vp-p	8191	+2.5 V
5 Vp-p	4095	+1.25 V
5 Vp-p	0	0V (offset voltage)
9 Vp-p	-4095	-4.5 V
4 Vp-p	-8191	-2 V

F3:OFST - Selects the Offset parameter. Change the offset by using the cursor keys, rotary dial or numerical keypad. If a certain setting cannot be produced, the waveform generator will display a “Setting Conflict” message.

F2:SYM - When the Square or Triangle waveforms are selected, the SYMMETRY option is available. Change the symmetry by using the cursor keys, rotary dial or numerical keypad. If a certain setting cannot be produced, the waveform generator will display a warning message.



Triangle Menu

F4: INTREF/EXTREF - Selects internal or external reference source for the generated standard waveforms (the external reference must be connected to the rear panel Ref In connector).

3.6.2 MODE Key

Selects the output mode: CONT (Continuous), TRIG (Triggered), GATE (Gated), and BRST (Burst). To select the output mode, press MODE, then press the function key that corresponds to the desired Mode menu option, as shown:



Mode Menu

F1: CONT - (Continuous) - Selects continuous output.

F2: TRIG/BRST - (Triggered) - Triggers one output cycle of the selected waveform for each trigger event.
- (Burst) - Triggers output N cycles for each trigger event, where N ranges from 2 to 999,999.

F3: GATE - (Gated) - Triggers output cycles as long as the trigger source asserts the gate signal.

F4: PHASE - Selects the start phase of the signal in non-continuous modes. The range is from -360° to $+360^\circ$, with a 0.1° resolution. In PHASE mode **F2: SET-ZERO** sets the phase reference to zero when few instruments are connected to the same external reference and need to be synchronized with different phase relations.

After selecting the TRIG , GATE or BURST menu, the trigger source menu is available:

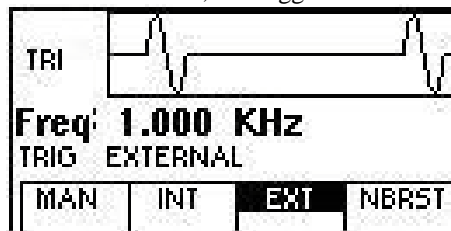

Trigger Menu

F1: MAN - Selects manual as the trigger source. To trigger the waveform generator, press this MAN TRIG again.

F2: INT - Selects the internal trigger generator as the trigger source. Change the internal trigger rate displayed with the rotary input knob.

F3: EXT - Selects the external trigger signal as the trigger source. The trigger source is supplied through the TRIG IN connector.

F4: NBRST - Selects the number of burst pulses to be output with each trigger. The N can be changed from 2 to 999,999.

3.6.3 ARBITRARY Key

When selected displays the following screen:



Arbitrary Menu

F1: FREQ/RATE - (Frequency) Selects and displays the frequency. Change the frequency setting using the cursor keys, rotary knob or numerical keys. If a certain wavelength can't produce the waveform at the desired frequency, the waveform generator displays an "Out of Range" error message. Displays the Point Rate (for Arbitrary Waveform only). The Rate parameter governs the rate at which waveform points are executed, and thus the frequency of the waveform output. When you set this parameter, the waveform generator will keep that execution rate for all waveform lengths until it is changed.

F2: ARB - Selects the Arbitrary editing menu:

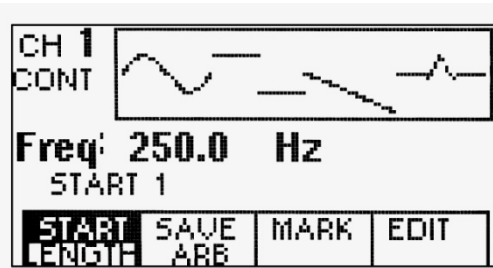

Arbitrary Editing Menu

F1: START/LENGTH - Selects the starting address of the arbitrary waveform.

Note: The starting address always has to be an odd number. If an even number is entered, it will automatically decrement one value to an odd number. For example, if you set start address to 2000 and press ENTER, it will display 1999.

- Selects the length of the arbitrary waveform. Use the START and LENGTH menu selection to mark a selection of the waveform memory that will be executed.

Note: The length value must always be an even number. If you input an odd number length, a message will pop up and say "Even wave length" and then decrement one value to an even number. For example, if you entered 1001 as the length, the message will pop up for one second and change the value automatically to 1000.

F2: SAVE ARB - Selecting this will save the current Arbitrary waveform data points so that it

can be recalled when revisiting the ARB menu later on or when power cycling the instrument.

Note: The 4075 and 4078 can both save multiple numbers of waveforms because the instruments have one large memory bank to store up to 400,000 points total. Essentially, the user can store multiple waves with various lengths in different locations in the memory. This can be done simply by generating each of the waveforms with different starting addresses. As long as the lengths of each do not overlap, user can save as much waveforms with different lengths as desired (Total points of all waveforms cannot exceed 400,000 points). If user has multiple waveforms to create and do not want to remember all the different starting addresses and lengths, there is a “STORE” and “RECALL” feature explained in section 3.6.6 that will allow you to store and recall up to 50 settings (Note: Only 49 settings can be restores because 50 is reserved for restoring last known working state of the instrument). Each setting can save all the waveform parameters, configurations, modes, starting address, length and more. (Refer to Table 3-2 in section 3.10 to see entire list of stored parameters) This way, user can quickly recall back the different waves stored in the memory. Refer to section 3.6.6 for details.

F3: MARK

- (Marker Output) Selects the marker output address of the signal to be available at the Marker Out connector. The **F1:ADDR**, **F2:LENGTH** or **F3:ON/OFF** can be selected and the Marker output signal can be available at any desired location address between the start and stop addresses of the executed waveform. This marker output feature will allow you to generate a positive TTL level output signal at the points specified by address and length.

Note: The maximum LENGTH allowed to be set for marker is 4000.

Below is an example to illustrate how marker function works:

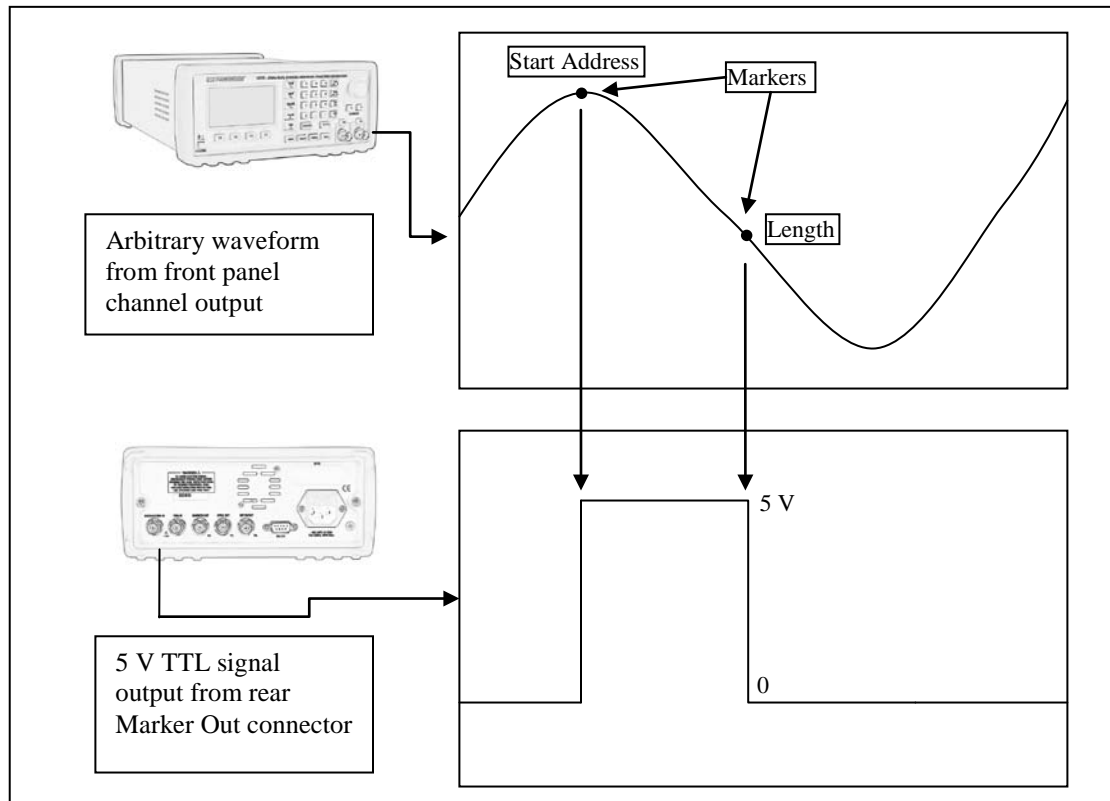

Marker Function Illustration

F4: EDIT - Refer to section 3.6.4 below for details.

**Changing one of the arbitrary parameters as start and length causes an update of the output waveform to the new parameters. When exiting the Arbitrary Menu by selecting a different waveform, a message to save the Arbitrary wave will be displayed. Select YES or NO to save the new waveform. This save functions the same as the SAVE ARB function.

F3: AMPL/OFST - Selects the Amplitude or Offset parameter.

In Arbitrary mode, this setting defines the maximum peak-to-peak amplitude of a full-scale waveform. If the waveform does not use the full scale of data (-8191 to +8191), then its actual amplitude will be smaller.

- Selects the Offset parameter. Change the offset by using the cursor keys, rotary knob or numerical keypad. If a certain setting cannot be produced, the waveform generator will display a "Setting Conflict" message.

F4: INTCLK/EXTCLK - Selects between using the internal clock or external clock.

For Model 4078 only:

For the 4078 with dual channels, channel 1 (CH1) is the MASTER channel. If selected for external clock (EXTCLK), the same clock will also be applied to channel 2 (CH2) if EXTCLK is also selected in CH2. (Note: There is only one BNC connector for external clock input, which is common to both channels)

3.6.4 Arbitrary EDIT Menu

Enters data for creating arbitrary waveforms. You can enter data one point at a time, as a value at an address, draw a line from one point (a value at an address) to another point, create a predefined waveform, or combine these to create complex waveforms. The valid data values range is -8191 to 8191. The valid waveform memory addresses range from 1 to 400,000.

The data value governs the output amplitude of that point of the waveform, scaled to the instrument output amplitude. Therefore, a value of 8191 corresponds to positive peak amplitude, 0 corresponds to the waveform offset, and -8191 corresponds to the negative peak amplitude.

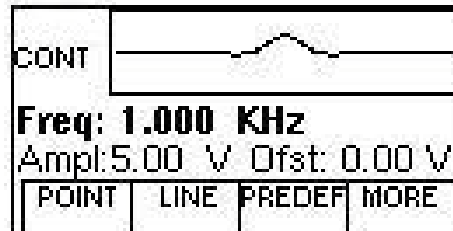

Edit Menu

F1: POINT - This menu allows point by point waveform editing. When selected, the following menu is displayed:

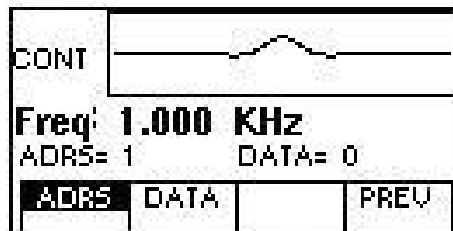

Point Menu

F1: ADRS - Select the current address in the arbitrary waveform memory.

F2: DATA - Selects the data point value at the current address. You can change the point value from -8191 to 8191.

F4: PREV - Goes back to previous menu (Edit menu).

F2: LINE - This menu allows a line drawing between two selected points. Displays the following menu:

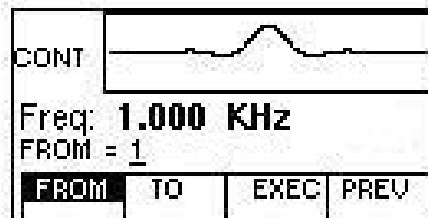

Line Menu

- F1: FROM** - Selects the starting point address.
- F2: TO** - Selects the ending point address.
- F4: EXEC** - Displays the Confirmation menu, **F1:NO** and **F3:YES**

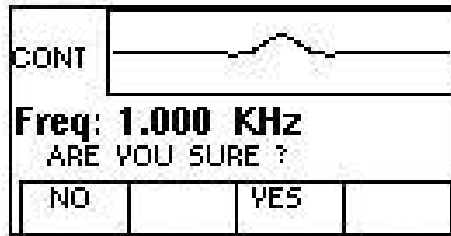

Confirmation Menu

- F3: PREDEF** - (Predefined Waveforms) Selects one of the predefined waveforms: Sine, Triangle, Square and Noise. Displays the Predefined waveforms menu:

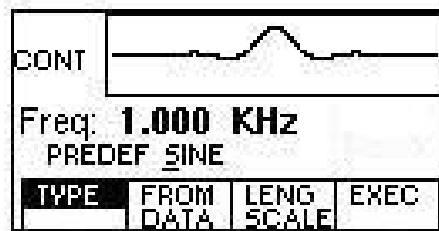

Predefine Menu

F1: TYPE - Selects the waveform Sine, Triangle, Square, Noise, Ramp up, Ramp down, exponential, Sin(x)/x, and Gaussian distribution. If Noise function is selected, a submenu is displayed to allow adding the noise to an available waveform or to generate it as a new noise waveform.

F2: FROM DATA - Selects the starting point of the generated waveform and data value.

F3: LENG/SCALE - Selects the length of the predefined waveform (number of points for a full wave). The length value must be a number that is divisible by 4 or by 2 in some instances. If not, a pop up message will say “Must divide by 4” or “Must divide by 2” and entered values will change back to its original. Different waveforms have different limitations on the length. Refer to Table 3-1 below. If scale is too high, a message will display “Scale too high.”

Table 3-1: Waveform Length Limits for Predefined Waveforms

Wave	Minimum Length	Divisible by
Sine	16	4
Triangle	16	4
Square	2	2
Noise	16	1

F3: SCALE - Selects the scale factor of the waveform. 100% means that the waveform spans the full scale of -8191 to 8191. Scale factors are limited by the point data

value of the starting point and automatically calculated by the unit.

F4: EXEC - Prompts you to confirm whether to execute the selected predefined waveform. Press NO to abort executing the predefined waveform; press YES to execute the predefined waveform. On the NOISE function a menu of ADD and NEW is prompt to select a new noise waveform or to add noise to the existing waveform.

F4: MORE - Displays the following Menu:

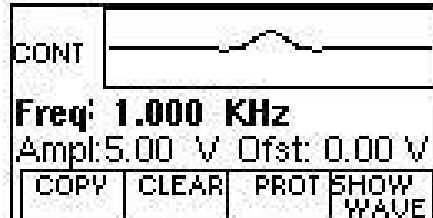

Arbitrary Option Display

F1: COPY - Displays the Copy menu (see the Copy Function later in this section).

F2: CLEAR - Displays the Clear menu (see the Clear Function later in this section).

F3: PROT - Displays the Protect menu (see the Protect Function later in this section).

F4: SHOW WAVE - Display the Arbitrary waveform in full screen mode on LCD display. This is only an approximated display for quick viewing. It does not represent the exact waveform being generated. To return back to the MENU selection, press any button.

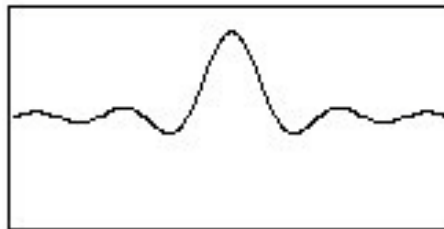

Full Display Example

Copy Function. Copies an area of waveform memory to another area of waveform memory.

F1: FROM - Selects the address of the first point to copy.

F2: LENG - Selects the length (number of points) of the waveform to copy.

F3: TO - Selects the destination address where the first point is copied.

F4: EXEC - Prompts you to confirm whether to copy. Press NO to abort copying, YES to copy.

Clear Function. Clears (sets the data values to zero) either a section of or all of waveform memory.

F1: FROM - Selects the address of the first point to clear.

F2: TO - Selects the address of the last point to clear.

F3: ALL - Clears the whole waveform memory. Equivalent to selecting from 1 to 400,000.

F4: EXEC - Prompts you to confirm whether to clear. Press NO to abort clearing, YES to clear.

Protect Function. Protects (makes read-only) a section of waveform memory.

F1: FROM - Selects the address of the first point to protect.

F2: TO - Selects the address of the last point to protect.

F3: ALL - Protects the whole waveform memory. Equivalent to selecting from 1 to 400,000.

Note: You can protect only one segment of waveform memory at a time.

F4: ON/OFF - Selects the unprotect mode and resets memory protection so that the whole waveform memory can be written into.

3.6.5 PULSE Menu



Pulse Menu

F2: PULSE - Selects the Pulse parameters entry.

And then:

F1: FREQ/PERIOD - Selects the parameter definition of the Pulse repetition period.

F2: WIDTH - Selects the Width of the generated pulse.

F3: EQUAL EDGE - Selects equal Rise (Leading edge) and Fall (Trailing edge) times of the pulse.

F4: LEAD-TRAIL - Selects different Rise and Fall times of the Pulse.

3.6.6 UTILITY Key



Utility Menu

F1: GPIB - (optional) Selects the GPIB remote mode of operation. After selection the GPIB address can be set to any value from 1 to 31 using the rotary knob. The value is kept in a nonvolatile memory and used at power-on. The factory default address is 9. Setting the address to 31 puts the device in the off-bus state (it will not respond to messages on the GPIB bus).

F1:RS232 - Selects the RS232 remote control mode. After selection, the baud rate can be selected as 2400, 9600, and 19200. The RS-232 uses 8 bit data, 1 stop bit and no parity.

F2: RECALL - Recalls a previously stored front-panel setup from the selected buffer. Change the buffer number by using the rotary input knob. Valid storage buffer numbers are from 0 to 49. Buffer 0 is the factory default setup.

F2: STORE - Stores the current front-panel setup to the specified storage buffer. Change the buffer number by using the numeric keypad or the rotary input knob. Valid storage buffer numbers range from 1 to 49. Below is a list of parameters that can be stored in each buffer.

Note: Location 50 is for last working setup before power down.

List of Stored Parameters

Stored Parameters
FREQUENCY
RATE(ARB)
AMPLITUDE
FUNCTION
OFFSET
REPETITION
MODE
N-BURST
START ADRS
WAVELENGTH
TRIG SOURCE
*OUTPUT
SWEEP
MODULATION

*For power-on setting, channel output status is not saved and cannot be recalled. For example, if channel output is ON when storing into memory, it cannot be recalled when that memory is set for power-on setting. In which case, at power on status of the channel output will always be disabled. This is for safety reasons because in some cases, if device connected to the generator is sensitive to signal level, accidentally powering the instrument ON with the output on may damage the device right away.

**The RECALL and STORE function can be used as a tool to store and locate many arbitrary waveforms. Because the 4075 and 4078 are designed with one large memory bank (up to 400,000

points of storage), users can have the freedom to store as many waveforms of different lengths as they desired in a dynamic fashion (with the limit of total points not to exceed memory capacity). Then, by using STORE and RECALL functions to save the starting address and lengths of each created arbitrary waveforms, users can quickly locate (in the memory) and output each of the different waves. These functions can behave like reference points, so users can actually save up to 49 different waveform reference points in the memory.

See example illustration below to see how it works:

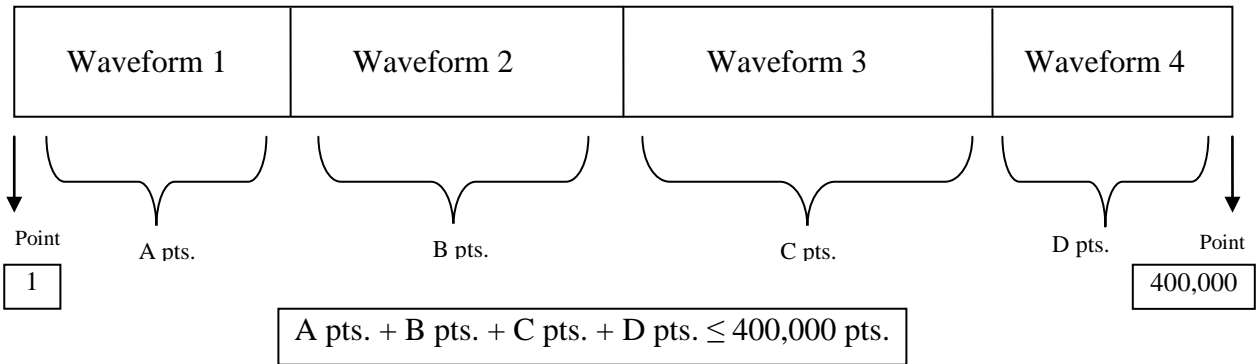

Stored Buffer number	Data points of different waveforms (Start address + length)
1	A pts.
2	B pts.
3	C pts.
4	D pts.

From the above illustration, all the points of Waveform 1 can be stored and recalled using buffer #1. Likewise, Waveform 2 can be stored/recalled by buffer #2. Waveform 3 by buffer #3. Waveform 4 by buffer #4.

F3: POWER - (Power-on default) Selects the power-on default setting. Select a value using the numeric keypad or the rotary input knob. The selection is effective after a 10 s time-out period. Select zero (0) to have the waveform generator power on with the factory default settings. Select 50 to have the waveform generator power-on with the settings it had at the last power-off. Select any other value in the range from 1 to 49 to have the waveform generator power-on with the settings that you have saved with **F2:STORE**(*see above*) in the range of 1 to 49.

Note: Channel output status can be stored and recalled in memory, but cannot be recalled for power-on setting. Meaning, at any given time, at power on the channel output status will always be OFF regardless of what memory block power-on setting is set to recall at power up. This is a safety feature because if user accidentally turns on with the outputs on, sometimes it can easily damage a connected device that is sensitive to signal levels connected to it.

3.6.7 SWEEP Key

Selects the Sweep Mode and allows the entering of sweep parameters as Sweep Start, Sweep Stop and Sweep

Rate.

To select the sweep mode, press SWEEP, then press the function key that corresponds to the desired Sweep menu option, as shown:



Sweep Menu

- F1: ON/OFF** - Operates the sweep function, selecting between Sweep On or Off.
- F2: START/STOP** - Defines the Sweep Start and Stop frequencies.
- F3: RATE** - Defines the Sweep Rate.
- F4: LIN/LOG** - Selects the Sweep Shape, LIN or LOG.



Log Sweep Menu

3.6.7.1 How to Setup Sweep in Different Modes

By default, turning ON the sweep function will automatically set to a continuous (CONT) sweep. In order to change to other modes of sweep, do the following:

1. Set sweep to ON **FIRST** by pressing **F1**.
2. Then, press the **MODE** button on front panel.
3. Select between triggered (**TRIG**), burst (**BURST**) or gated (**GATE**) mode.

Note: If this is done before turning on sweep, sweep ON selection will automatically reset to default (which sweeps in continuous mode).

3.6.8 MODULATION Key

Selects the Modulation mode **AM**, **FM** or **FSK**.

To select the output mode, press **MODUL** key, then press the function key that corresponds to the desired menu option, as shown:



Modulation Menu

F1: AM

If the **AM** is selected, the following menu is available:



AM Menu

- F1: ON/OFF** - Selects the Modulation ON or OFF operating mode.
- F2: % /SHAPE** - Defines the modulation depth (from 0 to 100%) and the modulation shape between SINE, TRIANGLE or SQUARE .
- F3: MOD-FREQ** - Selects the modulation frequency, from 0.1 Hz to 20.00 KHz.
- F4: EXT/INT** - Selects and enables the external modulation by an external signal applied to the Modulation In connector.

F2: FM

If the **FM** is selected, the following menu is available:



FM Menu

- F1: ON/OFF** - Selects the Modulation ON or OFF operating mode.
- F2: DEV/ SHAPE** - Defines the FM deviation frequency or the modulation shape, between SINE, TRIANGLE or SQUARE.
- F3: MOD-FREQ** - Selects the modulation frequency, from 0.1 Hz to 20.00 KHz.
- F4: EXT/INT** - Selects and enables the external modulation by an external signal applied to the

Modulation In connector.

F3: FSK

If the **FSK** is selected, the following menu is available:



FSK Menu

- F1: ON/OFF** - Selects the FSK ON or OFF operating mode.
- F2: F-HI/F-LO** - Defines the High and Low frequency of the FSK.
- F3: RATE** - Selects the rate of alternation between the low and high frequencies.
- F5: EXT/INT** - Selects and enables the external FSK when the unit frequency is alternating between the low and high frequencies by an external signal applied to the Trig In connector.

3.7 ON Key

Use these key to control the main output signal. When the output is active, an internal LED will illuminate the button.

3.8 Cursor Movement Keys

Use these keys to move the cursor (when visible) either left or right. They are used in conjunction with the rotary input knob to set the step size of the rotary input knob.

3.9 Rotary Input Knob

Use this knob to increase and decrease numeric values or to scroll through a list. The cursor indicates the low-order position of the displayed value which changes when you rotate the knob (for straight numeric entries only). For other types of data, the whole value changes when you rotate the knob.

3.10 Power-On Settings

At power-on, the waveform generator performs a diagnostic self-test procedure to check itself for errors. If it finds an error, an error code and text will appear in the display window. Other error codes appear when you enter an invalid front-panel setting. *For more information on error codes, see the Error Indication section 3.12.*

When the waveform generator finishes the diagnostic self-test routine, it enters the local state (LOGS) and assumes

power-on default settings. Table 3-2 lists the factory default settings. You can program the waveform generator for any settings you want at power on, as described earlier in section 3.6.6.

Note: OUTPUT status saved into memory cannot be recalled for power-on setting. This is a safety feature to prevent sensitive devices connected to the generator from being damaged if user accidentally turns on the unit.

Table 3-2
Power-on Default Settings

Key Functions	Values	Comments
FREQUENCY	1.00000000 KHz	Wave frequency
RATE(ARB)	1 μ s	Sample time per point
AMPLITUDE	5.00 V	Peak to peak output amplitude
FUNCTION	SINE	Output waveform
OFFSET	0.00 V	Zero offset
REPETITION	10 ms	Internal trigger rate
MODE	CONT	Waveform mode
N-BURST	2	Waves per burst
START ADRS	1	Start memory address
WAVELENGTH	1000	Number of points per waveform
TRIG SOURCE	EXT	External trigger source
OUTPUT	OFF	Output disabled
SWEEP	OFF	Sweep execution
MODULATION	OFF	Modulation execution

3.11 Memory

The waveform generator uses a non-volatile FLASH memory for storing arbitrary waveform data and front panel settings. Up to 400,000 points Arbitrary waveform and 50 front panel settings are stored. These front panel settings can be used to store starting address and lengths of many different waveforms stored in memory as reference points for quick recall.

Because it is impossible to guarantee 100% of the time against loss of stored data, you should maintain a record of the data stored in memory so that you can manually restore such data, if necessary.

3.12 Displaying Errors

At power-on, the waveform generator performs a diagnostic routine to check itself for problems. If the diagnostic routine finds an error, an error message is displayed. The waveform generator also displays error messages when front-panel settings are either invalid or may produce unexpected results.

Error messages for Model 4075 and 4078

Message Text	Cause
Out of range	Attempt to set variable out of instrument limits.

Setting conflict	Can't have this parameter set with some other.
Trig rate short	Internal trigger rate too short for wave/burst.
Empty location	Attempt to restore non existent setting.
SCALE too high	Attempt to set scale too high for current dot value
Protected RAM	Attempt to write to protected RAM range.
Save RAM	New firmware installed.
Must divide by 4	Predefined wave length must be divisible by 4.
Must divide by 2	Predefined wave length must be divisible by 2.

3.13 Using Model 4075 and 4078

This section explains how to generate various waveforms and modify the output waveforms.

3.13.1 Selecting a Standard Waveform

You can select several standard waveforms as: sine, triangle and square. Creating a standard waveform requires selecting the waveform type, parameters, modes, etc., and their settings that define the waveform.

Generating a standard waveform requires the following:

- * Selecting the waveform by pushing any of the waveform buttons (Sine, Ramp, Square, Pulse, or Arb)
- * Setting the output frequency by using the rotary input knob or numeric keypad to enter the desired frequency.
- * Setting the output amplitude and offset by selecting the option in the function menu and using the rotary input knob or numeric keyboard to enter the desired amplitude and/or offset.

3.13.2 Setting the Output Mode

To set the output mode:

1. Press MODE to display the Mode menu on the display window.
2. Press the function key (F1 to F4) that corresponds to the desired mode. Choose from Continuous, Trigger, Burst, and Gate mode. You can also adjust the Phase in the same menu.

3.13.3 Setting the Output

To set the output channel, press the Output ON key. An internal LED is illuminated to indicate that the Output is ON.

3.14 Examples

3.14.1 Creating an Arbitrary Waveform

You can create an arbitrary waveform using the following methods:

- * Enter individual data points

- * Draw lines between data points
- * Create a predefined waveform
- * Export waveform from software
- * Create data points using SCPI commands
- * Combine any of these methods

The waveform's frequency and amplitude are influenced by the number of data points and their value in the waveform. For further information on how the number of data points influence the frequency and amplitude of a waveform in execution memory, see Setting the Frequency portion (*Section 3.14.3*) and Setting the Amplitude portion (*Section 3.14.4*), respectively.

3.14.2 Entering Individual Data Points

The most basic way to program an arbitrary waveform is to enter data points for the waveform, one data point at a time. While this can become tedious, the auto-increment function helps this process.

To enter individual data points into waveform memory, follow these steps:

1. Press ARB main key to display the selection menu.
2. Press F2: ARB to display the arbitrary menu.
3. Press F4:EDIT to display the Edit menu.
4. Press F1:POINT, to select the point by point programming mode.
5. Press F1:ADRS
6. Use the rotary knob or the numerical keypad to enter the address.
7. Press F2:DATA.
8. Use the rotary knob or the numerical keypad to enter the value for the data point. Valid entries range from -8191 to 8191.
9. Repeat steps 5 through 8 for additional points until you finish creating your arbitrary waveform.

Note: *Each time you press ENTER to complete a data point entry in numerical mode, the auto-increment address advances the "A= value" by one.*

3.14.3 Setting the Arbitrary Frequency

The arbitrary waveform frequency is a function of the number of data points used to run the waveform (the length parameter in the ARB menu) and the waveform execution point rate. The waveform execution point rate is the execution time between each point in the waveform. The total time taken to run one period of the waveform is given by:

$$Total\ time = \#\ of\ points \cdot rate$$

Because the output frequency is a function of the rate and the number of points being executed, the output frequency is calculated as:

$$frequency = \frac{1}{\#\ of\ points \cdot rate}$$

For example, to set the output frequency to 1000 Hz, given the number of data points used for the waveform output is 1000, the rate is calculated as:

$$rate = \frac{1}{1000 \text{ pts} \cdot 1000 \text{ Hz}} = 1 \mu s$$

EXAMPLE: Setting the Output Frequency

To set the output frequency of a 1000 point waveform in execution memory to 1000 Hz, set the rate to 1 μ s:

ACTION	KEYSTROKES
Step 1. Set the output rate to 1 μ s (equivalent to 1000 Hz output frequency)	PARAMETER F1 :RATE 1 KHz/us

3.14.4 Setting the Amplitude

The following equation represents the relative output amplitude voltage relationship between the front-panel amplitude peak-to-peak setting and the data point values in waveform memory:

$$output \ voltage = \frac{Amplitude \ p - p \ setting \cdot \ data \ point \ value}{16382} + \ offset$$

Where 16382 is the total data point value range in waveform memory.

Table 3-4: Relative Amplitude for Waveform Output (Examples)

Front Panel Amplitude Setting	Data Point Value	Relative Output Amplitude Voltage
5 V peak-to-peak	8191	2.5 V positive peak
5 V peak-to-peak	0	0 V (offset voltage)
10 V peak-to-peak	-8191	5 V positive peak

3.14.5 Executing an Arbitrary Waveform

To load a waveform into execution memory, specify its starting address and length in the ARB menu.

1. Select the channel to ON.
2. Press the ARB key and select the F2:ARB function.
3. Press F1:START to set the address. Valid entries range from 1 to 399,999.

Note: *The starting address always has to be an odd number. If an even number is entered, it will automatically decrement one value to an odd number. For example, if you set start address to 2000 and press ENTER, it will display 1999.*

4. Press F2:LENGTH to set the length of the waveform.
5. Use the rotary input knob or the numerical keypad to enter the waveform length. Valid entries range from 2 to 400,000.

Note: *The length value must always be an even number. If you input an odd number length, a message will pop up and say "Even wave length" and then decrement one value to an even number. For example, if you entered 1001 as the length, the message will pop up for one second and change the value automatically to 1000.*

3.14.6 Using Voltage Offset

Through the offset parameter you can add a positive or negative DC level to the output waveform.

To set voltage offset:

1. Press Waveform to display the menu.
2. Press F3 :OFST to display the offset setting.
3. Use the rotary input knob or the numerical keys to set the voltage offset.

To turn the voltage offset OFF, repeat the steps above, but set the offset voltage level to 0.

3.14.7 Storing and Recalling a Waveform Generator Setup

You can store up to 49 front-panel setups in a part of non-volatile Flash known as the settings storage memory. When you recall a stored setup, the front-panel settings change to match the settings in the stored setup. These stored and recalled settings include the starting address and length of the arbitrary memory that is loaded in the execution memory.

Storing Setups

To store the front-panel setup:

1. Press UTILITY to display the menu.
2. Press F2:STORE to select the Store mode.
3. Use the rotary input knob to select a buffer number. Valid buffer numbers range from 1 to 49. Buffer 0 is a read-only buffer that contains the power-on settings listed in Table 3-2.

Note: *The waveform generator does not warn you when you store a setup into a settings buffer that is already occupied.*

Recalling Setups. To recall stored front-panel setup:

1. Press UTILITY to display the menu.
2. Press F2:RECALL to select the Recall mode.
3. Use the rotary input knob to select a buffer number. Valid buffers numbers range from 0 to 49. Buffer 0 is a read-only buffer that contains the power-on settings listed in Table 3-2.

Section 4

Programming

4.1 Overview

4.1.1 GPIB

This section provides detailed information on programming the 4075 and 4078 via the IEEE 488 bus (referred to from now as the GPIB - General Purpose Interface Bus). The 4075 and 4078 are programmable over the IEEE 488.1 bus, and its message protocol is compatible with IEEE 488.2. The device command set is compatible with the SCPI 1992.0 standard.

The command syntax as defined by the IEEE 488.2 and SCPI standards is briefly explained in the following sections. Users who have experience programming GPIB instruments may skip these paragraphs, and go directly to where the individual command syntax is given in *sections 4.12 and 4.13*. Considering the relative newness of these standards, it is recommended to all users to read the explanations given here. Users wishing to gain further insight should consult the standards.

4.1.2 RS-232-C

The RS-232-C standard is not very specific about many of the handshaking signals and it is therefore usually necessary to refer to the manuals for both of the devices being connected to determine the exact pin out, signal definition, and signal direction for the devices. *Refer to section 2.9*.

The serial interface implements the same SCPI command set as the GPIB interface. This includes commands stated in *sections 4.12 and 4.13*. Refer to these sections for syntax details. The instrument is programmed by sending ASCII coded characters to the instrument.

When the instrument is in the remote mode, remote command input has priority over any front panel control. Therefore, as long as the serial interface is continuously supplied with data, the keyboard will appear to be inoperative to the user.

Note: In remote mode, any command sent or receive via RS232 will change the display screen with the following:



User can return to local control with the press of any front panel keys, but it is extremely important to note that this should be done ONLY when nothing is being sent or transferred between the instrument and the connected PC. Any interruptions during transfer may delay the communication process. For large waveforms transmission, be it sending or receiving, please allow at least 15 seconds before pressing any front panel keys to return to local mode. The instrument needs the additional time to completely generate or send the waveform.

The instrument accepts a carriage return (CR) as an end of string (EOS) terminator and sends both a CR and LF as the EOS terminator.

4.2 Device State

The device may be in one of the four possible states described below. The transition between states is defined by IEEE 488.1.

4.2.1 Local State (LOCS)

In the LOCS the device may be operated from the front panel only. Its settings may be queried over the GPIB, but not changed. Commands that do not affect the signal being output by the instrument are accepted.

4.2.2 Local With Lockout State (LWLS)

In the LWLS the device may be operated from the front panel only. Its settings may be queried over the GPIB, but not changed. Commands that do not affect the signal being output by the instrument are accepted. The difference between the LOCS and the LWLS is that from the LWLS the device may enter the Remote With Lockout State.

4.2.3 Remote State (REMS)

In the REMS the device may be operated from the GPIB. Actuating any front panel key will cause the device state to revert to the LOCS.

4.2.4 Remote With Lockout State (RWLS)

In the RWLS the device is operable only from the GPIB. Front panel operation may be returned by either sending an appropriate IEEE 488.1 command, or by cycling the device power.

4.3 Interface Function Subsets

The following interface function subsets are implemented in the MODEL 4075 and 4078:

SH1, AH1, T6, L4, SR1, RL1, PP0, DC1, DT1, E2, C0

4.4 Device Address

The GPIB address of the device may be set to any value from 0 to 31. The address may be changed from the front panel, using the numeric keypad or the rotary encoder, or via the GPIB itself using the command:

```
:SYSTem:COMMunicate:GPIB:ADDRess
```

Setting the device to address 31 puts it in the 'off-bus' state. In this state it will not respond to messages on the GPIB. If the device is in the REMS when set to address 31, an internal 'return-to-local' command will be given, setting the device to the LOCS. If the device is in the RWLS, the 'return-to-local' command is ignored, and the device remains in the RWLS. The only way to then re-establish communication with the device over the GPIB is to cycle the power, and to then change the address to that required from the front panel.

4.5 Message Exchange Protocol

The device decodes messages using the Message Exchange Protocol (MEP) defined in IEEE 488.2. The following functions implemented in the MEP must be considered:

4.5.1 The Input Buffer

The device has a 256-byte long cyclic input buffer. Decoding of remote messages begins as soon as the input buffer is not empty, that is, as soon as the controller has sent at least one byte to the device. Should the input buffer be filled up by the controller faster than the device can remove the bytes and decode them, the bus handshake is not completed until room has been made for more bytes in the buffer. This prevents a fast controller from overrunning the device with data.

If the user has sent part of a Program Message, but not the Program Message Terminator, and he wishes to abort the message decoding and execution, the Device Clear command may be sent, or front panel operation resumed (in REMS only).

4.5.2 The Output Queue

The device has a 100-byte long output queue in which it stores response messages for the controller to read. If at the time a response message is formatted the queue contains previously formatted response messages, such that there are not enough places in the queue for the new message, the device will put off putting the message in the queue until there is place for it.

The Status Byte MAV bit, when set, indicates that part or all of a response message is ready to be read.

4.5.3 Response Messages

The device sends a Response Message in response to a valid query. All queries return a single Response Message Unit. In only one case is the Response Message generated when the response is read (as opposed to when the response is parsed), and this is when querying Arbitrary Waveform data. All other queries generate the Response Message when they are parsed.

4.5.4 Coupled Commands

Coupled Commands are either commands whose execution validity depends on the value of other parameters, or commands whose execution changes the value of another parameter. The execution of commands designated as being coupled is deferred until all other commands in the same Program Message have been executed. The coupled commands are then grouped together according to their functionality, and executed as a group. These groups of coupled commands are defined in the MODEL 4075 and 4078:

- a) The commands to set the amplitude, the offset, and to switch the output on. The output being switched on is included here in order to prevent possible damage to the equipment being driven as a result of the amplitude and offset not being executed as intended by the user, due to an execution error.
- b) The commands to set the function, frequency, the point rate, the wavelength, and the waveform start address. In ARB function, setting the frequency or the point rate causes the other to change, keeping the wavelength constant (if it, too, is not specified in the same program message). If the wavelength is specified as well, the frequency or point rate must change in accordance with the new value. The validity of the start address is a function of the wavelength. Please refer to the individual commands for more detail.
The maximum frequency is also dependent upon the waveform, so that changing the waveform may render the

current frequency out of range.

c) The commands to set modulation, modulation source and the function are inter-related. FM and FSK are not available for ARB function. External source of modulation can be active for either FM or AM but not both. FSK and FM cannot be active at the same time.

d) Sweep start and sweep stop frequencies must be distanced more than the minimum allowed for sweep to function correctly.

4.6 Block Data (GPIB Only)

Arbitrary waveform values may be sent to the device in one of three formats:

- a) ASCII values,
- b) Definite form arbitrary data, and
- c) Indefinite form arbitrary data.

4.7 Instrument Identification

The *IDN? common query is used to read the instrument's identification string. The string returned is something similar to the following:

B&K, MODEL 4078,0,V1.03

4.8 Instrument Reset

The *RST common command effects an instrument reset to the factory default power up state.

4.9 Self Test

The *TST common query causes the device to perform a self test. This self test consists of checking the functionality of the arbitrary waveform memory.

4.10 Command Syntax

4.10.1 General Command Structure

The device commands are generally defined by the SCPI standard, with the exception of those instrument functions for which SCPI commands do not as yet exist. The Common Commands and Queries are defined by IEEE 488.2. The command syntax, i.e. how a command is structured, is defined by IEEE 488.2.

A Program Message is defined as a string containing one or more Program Message Units, each of which is an instrument command or query. Program Message Units are separated from each other by the Program Message Unit Separator. The Program Message is terminated by the Program Message Terminator.

The Program Message Unit Separator consists of a semicolon (;), optionally preceded and/or followed by whitespace characters. A whitespace character is defined as the ASCII characters in the ranges 00H-09H, and 0BH-20H. This range includes the ASCII control characters and the space, but excludes the Linefeed character.

The Program Message Terminator consists of optional whitespace characters, followed by one of three options:

- a) The Linefeed (LF) character (ASCII 0A);
- b) The GPIB EOI bus line being set true on the last byte of the message;

c) LF being sent with EOI true.

The Program Message Unit can be divided into three sections as follows:

a) Program Header

The Program Header represents the operation to be performed, and consists of ASCII character mnemonics. Two types of Program Headers are used in the 4075 & 4078: Instrument-control headers and Common Command and Query headers. A Program Header may consist of more than one mnemonic, in which case the mnemonics are separated from each other by the colon (:). For instrument control commands, the mnemonics are specified by the SCPI standard, and indicate the tree structure of the command set. The first mnemonic indicates the subsystem being controlled. Common Command and Query Program Headers consist of a single mnemonic prefixed by an asterisk (*).

The mnemonics consist of upper - or lower-case alpha characters. Mnemonics may be written in either the long form, in which the entire mnemonic is written out, or the short form, in which only a specified portion of the mnemonic is written out. Some mnemonics have only one form due to their short length. Where a command is described, the portion appearing in upper case is the short form. Only the short form or the long form may be used.

Example: The command to set the frequency to 1KHz may be written in the following ways:

```
SOURCE:FREQUENCY 1KHZ
SOUR:FREQ 1KHZ
SOURCE:FREQ 1KHZ
```

Some mnemonics in a specified Program Header may be optional. This is indicated in the command description by the mnemonic being enclosed in square brackets ([...]). This means it is not necessary to write the mnemonic into the Program Header: it is a default condition. The 'SOURCE' mnemonic, for example, is optional. Not specifying it will cause the device to search for the mnemonics in the Program Header under the Source Subsystem. For example, the frequency may be set by the commands

```
FREQ:CW 1KHz
FREQ 1KHz
```

since the 'CW' mnemonic is also optional.

b) Program Header Separator

The Program Header Separator is used to separate the program header from the program data. It consists of one or more whitespace characters, denoted as <ws>. Typically, it is a space.

c) Program Data

The Program Data represent the values of the parameters being set, for example, the '1KHz' in the above examples. Different forms of program data are accepted, depending on the command. The Program Data types used in the instrument are:

i) Character program data

This form of data is comprised of a mnemonic made up of lower - or upper-case alpha characters. As with Program Header mnemonics, some Character Data mnemonics have short and long forms. Only the short or the long form may be used.

ii) Boolean data

Boolean data indicate that the parameter can take one of two states, ON or OFF. The parameter may be character type
ON or OFF

or numeric. A numeric value is rounded to an integer. A non-zero result is interpreted as 1 (ON), and a zero result as 0 (OFF).

Queries return the values 0 or 1.

iii) NRf

This is a decimal numeric data type, where
NR1 indicates an integer number,
NR2 indicates a fixed point real number, and
NR3 indicates a floating point real number.

iv) Expression data

An expression is contained in parentheses (...). This data type is used only with the
STATus:QUEue:ENABle command.

v) Numeric value program data

This data type defines numeric values, as well as special cases of Character Data. Numeric values may be specified in any of Integer, Fixed Point or Floating Point format. All parameters which have associated units accept a suffix, which may be specified using upper or lower-case characters. When the suffix is not specified, the numeric value is accepted in the default units, which are Hertz for frequency, Seconds for time, and Volts for voltage. To set the frequency to 1 KHz we can send one of the following commands:

```
FREQ 1000  
FREQ 1E3
```

The special forms of character data accepted as numbers are

MAXimum: sets the parameter to its maximum value.
MINimum: sets the parameter to its minimum value.

For example, to set the frequency to its maximum value we can send the command

```
FREQ MAX
```

vi) Arbitrary Block Data

The Arbitrary block data type is used to send arbitrary waveform data to the instrument. In this data type, the waveform points are specified in binary format, and each point consists of two bytes. Two types of arbitrary block data are defined (by IEEE 488.2):

Definite Form

The Definite Form has the structure

-#-Byte Count Length - Byte Count - 8-bit byte

The Byte Count Length consists of a single ASCII digit from 1 to 9. It tells the parser how many digits are in the Byte Count.

The Byte Count is a decimal integer made up of the number of digits specified in the Byte Count Length. It tells the parser how many 8-bit bytes are being sent.

Indefinite Form

The Indefinite Form has the structure

- # - 0 – 8-bit byte – LF^EOI

Some Program Message Units either require, or can accept, more than one data element. Program data elements are separated from each other by the Program Data Separator. It is defined as optional whitespace characters followed by a comma (','), which in turn is followed by optional whitespace characters.

There are two types of Program Message Units: Command Message Units and Query Message Units. A Query differs from a Command in that the Program Header is terminated with a question mark ("?"). For example, the frequency might be queried with the following query:

FREQ?

Some Query Message Units accept data, giving the device more specific information about what is being queried. In many cases the Query Message Unit may optionally be supplied with the MIN or MAX mnemonics as data. This tells the device to return the minimum or maximum value to which the parameter may currently be set. For example,

FREQ? MAX

will return the maximum value to which the frequency may currently be set.

Not all Program Message units have query forms (for example, STATUS:PRESET), and some Program Message Units might have only the query form (for example SYSTEM:VERSION?).

The instrument puts the response to the query into the output queue, from where it may be read by the controller. The Status Byte MAV bit is set to indicate to the controller that a response is ready to be read.

4.10.2 SCPI Command Structure

SCPI commands are based on a hierarchical structure. This allows the same instrument-control header to be used several times for different purposes, providing that the mnemonic occurs in a unique position in the hierarchy. Each level in the hierarchy is defined as a node. Mnemonics in the different levels are separated from each other by a colon (':'). The first Program Message Unit, or command, in a Program Message is always referenced to the root node. Subsequent commands are referenced to the same level as the previous command. A Program Message Unit having a colon as its first character causes the reference to return to the root. This process is defined by IEEE 488.1, section A.1.1. Consider the following examples:

a) The following command may be used to set the amplitude and the offset of the signal.

SOURCE:VOLTAGE:AMPLITUDE 5V;OFFSET 2V

Note that the offset command is referenced to the command preceding it: the OFFSET mnemonic resides at the same node as the AMPLITUDE command.

b) This command set the frequency and the amplitude.

SOURCE:FREQUENCY 2KHZ;VOLTAGE:AMPLITUDE 4V

The FREQUENCY and VOLTAGE mnemonics are at the same level.

c) When Program Message Units describe different subsystems, a colon prefix must be used to reset the command reference to the root. Here the frequency and the output state are set.

SOURCE:FREQUENCY 3KHZ;:OUTPUT:STATE ON

Common Commands may be inserted in the Program Message without affecting the instrument-control command reference. For example,

```
SOURCE:VOLTAGE:AMPLITUDE 4V;*ESE 255;OFFSET 2V
```

FOR MODEL 4078 ONLY:

Exclusively for the model 4078 with multiple channels, the selection of which channel to use is achieved through the use of a numeric suffix indicating the channel, attached to the root level mnemonic. Four root level mnemonics are channel-dependent, and these are SOURce, TRIGger, OUTPut and ARBitary. When the channel is not specified, channel 1 is assumed by default. Program message units that are referred back to a specific root level mnemonic operate on the channel specified in that mnemonic.

Examples:

- a) SOUR:FREQ 5KHZ;VOLT:AMPL 3V
Sets the frequency and amplitude of the first channel (default).
- b) SOUR2:FREQ 5KHZ;VOLT:AMPL 3V
Sets the frequency and amplitude of channel 2.
- c) ARB2:START 100;LENGTH 50
Sets the start address and length of the waveform being output on channel 2.

4.11 Status Reporting

The instrument is capable of reporting status events and errors to the controller, using the IEEE 488.1 Service Request function and the IEEE 488.2 Status Reporting structure.

4.11.1 The Status Byte

Status summary information is communicated from the device to the controller using the Status Byte (STB). The STB is composed of single-bit summary-messages, each summary message summarizing an overlying Status Data Structure. By examining the content of the STB, the controller gains some information concerning the instrument's status.

The STB bits are defined as follows:

- Bit 0: Unused
- Bit 1: Unused
- Bit 2: Error/event queue summary message (EVQ). This bit is set if the queue is not empty.
- Bit 3: Questionable Status summary message.
- Bit 4: Message Available (MAV) summary message. This bit is set whenever all or part of a message is available for the controller to read. The controller may be ready to read the response message before it is available, in which case it can either wait until this bit is set, or it can start to read. In the second case, the controller timeout must be set so that the read action will not be aborted before the message has been read.
- Bit 5: Event Status Bit (ESB) summary message. This bit is set to indicate that one or more of the enabled standard events have occurred.
- Bit 6: Request Service (RQS). This bit is set when the device is actively requesting service.
- Bit 7: Operation Status summary message. No Operation Status events are defined in the instrument, and so this bit is never set.

The STB is read by the controller during a serial poll. If the RQS bit was set, it is then cleared. The STB may also be read by the *STB? common query.

4.11.2 Service Request Enabling

Service request enabling allows the user to select which Status Byte summary messages may cause the device to actively request service. This is achieved using the Service Request Enable Register, which is an 8-bit register whose bits correspond to those of the STB. The RQS bit in the STB is set when a bit in the STB is set, and its corresponding bit in the service request enable register is set.

The service request enable register is set using the *SRE common command, and read using the *SRE? common query.

4.11.3 Standard Event Status Register

The Standard Event Status Register (SESR) is defined by IEEE 488.2. It is implemented in the instrument as a byte, whose bits have the following definitions:

- Bit 0: Operation Complete (OPC). This bit is set in response to the *OPC common command being executed.
- Bit 1: Request Control (RQC). Not implemented.
- Bit 2: Query Error (QYE). This bit is set when either the controller is attempting to read data from the device when none is available, or when data prepared for the controller to read has been lost.
- Bit 3: Device-Specific Error (DDE). This bit is set to indicate that a device operation did not execute due to some device condition. For example, trying to recall an uninitialized device stored setting.
- Bit 4: Execution Error (EXE). This bit is set when the device could not execute a command, due to the command being outside of its capabilities. For example, a parameter being out of range.
- Bit 5: Command Error (CME). This bit is set to indicate an error in the command syntax.
- Bit 6: User Request (URQ). This bit is not used.
- Bit 7: Power On (PON). This bit is set when the device is powered on.

The SESR is queried using the *ESR? common query.

The SESR is paired with an enable register, the Standard Event Status Enable Register (SESER). This register enables one or more events in the SESR to be reflected in the Status Byte ESB summary message bit. The bits of the SESER correspond to those of the SESR. Setting a bit in the SESER enables the corresponding event to set the ESB bit when it occurs. The SESER is set with the *ESE common command and queried with the *ESE? command query.

4.11.4 The Error Queue

The error queue is used to store codes of errors detected in the device. It is implemented as a cyclic buffer of length 10. When the error queue is not empty, bit EVQ in the Status Byte is set. The error queue is read with either one of the following two queries:

```
:SYSTEM:ERROR?  
:STATUS:QUEUE:NEXT?
```

The first error in the queue is returned, and the queue is advanced.

4.11.5 Error Codes

The negative error codes are defined by SCPI. Positive codes are specific to the instrument.

The error message is returned in the form

<error number>,"<error description>"

A table of error numbers and their descriptions is presented here.

No error reported

0 No error

Command Errors

A command error is in the range -199 to -100, and indicates that a syntax error was detected. This includes the case of an unrecognized header. The occurrence of a command error causes the CME bit (bit 5) of the Standard Event Status Register to be set.

-100	Command Error
-101	Invalid character
-102	Syntax error
-103	Invalid separator
-104	Data type error
-105	GET not allowed
-108	Parameter not allowed
	More parameters than allowed were received
-109	Missing parameter
	Fewer parameters than necessary were received
-110	Command header error
-111	Header separator error
-112	Program mnemonic too long
	The mnemonic must contain no more than 12 characters.
-113	Undefined header
-120	Numeric data error
-121	Invalid character in number
-123	Exponent too large
	IEEE 488.2 specifies maximum of 32000
-124	Too many digits
	IEEE 488.2 specifies maximum of 255 digits in mantissa.
-128	Numeric data not allowed
	A different data type was expected
-131	Invalid suffix
-134	Suffix too long
	A maximum of 12 characters are allowed in a suffix.
-138	Suffix not allowed
-140	Character data error.
-141	Invalid character data.
	Incorrect character data were received.
-144	Character data too long
	Character data may contain no more than 12 characters.
-148	Character data not allowed
-158	String data not allowed
-161	Invalid block data
	An error was found in the block data
-168	Block data not allowed
-170	Expression error
	Only 6 error ranges may be specified.
-171	Invalid expression
	An error was found in the expression.

-178 Expression data not allowed

Execution Errors

An execution error indicates that the device could not execute a syntactically correct command, either since the data were out of the instrument's range, or due to a device condition. The EXE bit (bit 4) of the Standard Event Status Register is set on occurrence of an execution error.

- 200 Execution error
An attempt was made to RECALL the contents of an uninitialized stored setting buffer.
- 201 Invalid while in local.
- 211 Trigger ignored.
The GET or *TRG common command was ignored due to the device not being in the correct state to execute the trigger.
- 220 Parameter error.
A parameter is in the correct range, but conflicts with other parameters.
- 221 Settings conflict.
The parameter is out of range due to the current instrument state.
- 222 Data out of range.
- 223 Too much data.
The arbitrary waveform memory limit has been exceeded.
- 224 Illegal parameter value.
The parameter value must be selected from a finite list of possibilities.
- 258 Media protected.
An attempt was made to write to protected arbitrary waveform memory.

Device-Specific Errors

An error specific to the device occurred. The DDE bit (bit 3) of the Standard Event Status Register is set.

- 315 Configuration memory lost.
Device memory has been lost.
- 330 Self-test failed.
- 350 Queue overflow.
Error codes have been lost due to more than 10 errors being reported without being read.

Query Errors

A query error indicates that the output queue control has detected a problem. This could occur if either an attempt was made to read data from the instrument if none was available, or when data were lost. Data could be lost when a query causes data to be formatted for the controller to be read, and the controller sends more commands without reading the data.

- 410 Query INTERRUPTED.
Data were sent before the entire response of a previous query was read.
- 420 Query UNTERMINATED.
An attempt was made to read a response before the complete program message meant to generate that response was sent.
- 430 Query DEADLOCKED.
The input buffer and output queue are full, and the controller is attempting to send more data. In this case the output queue and input buffers will be cleared. Parsing will resume after the END message is detected.
- 440 Query UNTERMINATED after indefinite response.
A query was received in the same program message after a query requiring an indefinite response was formatted. Essentially this means that the *IDN? common query and the :ARB:DATA? query should not be followed by more query messages in the same program message.

System Events

System events have positive valued codes. They are not defined by SCPI, but are specific to the instrument. Sending the :STATus:PRESet command will disable these events from being reported.

401	Power on
402	Operation complete The *OPC command has been executed.

Warnings

The execution of some commands might cause an undesirable instrument state. The commands are executed, but a warning is issued. Sending the :STATus:PRESet command disables reporting of warnings. The existence of these conditions causes a bit in the Status Questionable Condition register to be set (refer to section 4.13.5.4).

For Model 4075

500	Trigger rate short
510	Output overload

For Model 4078

500	Trigger rate short on channel 1
501	Trigger rate short on channel 2
510	Output overload on channel 1
511	Output overload on channel 2

"Trigger rate short" means that the period of the waveform is larger than the value of the internal trigger rate. Thus not every trigger will generate a cycle (or burst) of the waveform.

4.12 Common Commands

The following section describes the common commands according to the IEEE 488.2 specifications. These commands are applicable for **both** GPIB and RS-232 interface.

4.12.1 System Data Commands

a) *IDN? - Identification query

The identification query enables unique identification of the device over the GPIB. This query should always be the last in a program message. It returns a string with four fields:

Manufacturer name
Model name
Serial number (0 if not relevant)
Version number

Command
Type: Common Query
Syntax: *IDN?

Response: B&K, MODEL 4078,0,V1.03

b) ***OPT?** - Option identification query

The Option Identification Query is used to identify device options over the system interface. This query should always be the last in a program message.

Command

Type: Common Query

Syntax: *OPT?

Response : No option available.

4.12.2 Internal Operation Commands

a) ***RST** - Reset command

The Reset command performs a device reset. It causes the device to return to the factory default power up state.

Type: Common Command

Syntax: *RST

b) ***TST?** - Self-test query

The self-test query causes an internal self-test to be performed. This test consists of checking the integrity of the arbitrary waveform memory.

Type: Common Query

Syntax: *TST?

Response: ASCII 0 if test passes
ASCII 1 if test fails

4.12.3 Synchronization Commands

a) ***OPC** - Operation complete command

The operation complete command causes the device to generate the operation complete message in the Standard Event Status Register, on completion of the selected device operation.

Type: Common Command

Syntax: *OPC

Examples: FREQ 5KHZ;*OPC

The *OPC command (and the *OPC? query described below) find use mainly when commands having relatively long execution times are executed, for example the programming of long predefined waveforms.

b) ***OPC?** - Operation complete query

The operation complete query places an ASCII character 1 in the output queue on completion of the selected device operation.

Type: Common Query

Syntax: *OPC?
Response: ASCII character 1
Example: FREQ 1KHz;*OPC?

c) ***WAI** - Wait-to-continue command

This command is intended for use with overlapped commands. No commands in the instrument are overlapped, and so this command has no effect.

Type: Common Command
Syntax: *WAI

4.12.4 Status and Event Commands

a) ***CLS** - Clear status

The clear status command clears the SESR and Error Queue status data structures.

Type: Common Command
Syntax: *CLS

b) ***ESE** - Standard event status enable

This command is used to set the value of the Standard Event Status Enable Register.

Arguments

Type: NRf
Range: 0 to 255. Non integer arguments are rounded before execution.
Type: Common Command or Query
Syntax: *ESE<ws><NRf>
Examples: *ESE 48 (Enables the CME and EXE bits)
 *ESE 255 (Enables all standard events)

Query

Syntax: *ESE?
Response: <NR1>

c) ***ESR?** - Standard event status register query

This query is used to read the value of the Standard Event Status Register. Reading the register clears it.

Type: Common Query
Syntax: *ESR?
Response: <NR1>

d) ***PSC** - Power on status clear command

This command is used to control the automatic power-on clearing of certain status functions.

Arguments

Type: Boolean
Type: Common Command or Query
Command
Syntax: *PSC<ws><Boolean>
Examples: *PSC ON or *PSC 1
 *PSC OFF or *PSC 0

Query

Syntax: *PSC?
Response: ASCII 0 for OFF
ASCII 1 for ON

When set to ON (1), the Service Request Enable Register and the Standard Event Status Enable Register are cleared on power-on.

e) ***SRE** - Service request enable command

This command sets the Service Request Enable Register bits.

Arguments

Type: NRf
Range: 0 to 255. Non integer arguments are rounded before execution.
The value of bit 6 is ignored, and is set always to zero.

Type: Common Command or Query
Command

Syntax: *SRE<ws><NRf>

Examples: *SRE 48 (Enables reporting of ESB and MAV events)

Query

Syntax: *SRE?

Response: <NR1>

f) ***STB?** - Status byte query

This query is used to read the value of the Status Byte.

Type: Common Query

Syntax: *STB?

Response: <NR1>

The value of the Status Byte read with the *STB? query may differ from that read with the Serial Poll. Bit 6 of the STB will be set as long as a reason for requesting service exists, while bit 6 of the STB as read by the Serial Poll is cleared by the Serial Poll.

4.12.5 Device Trigger Commands

a) ***TRG** - Trigger command

This command is analogous to the IEEE 488.1 Group Execute Trigger interface message, and has the same effect. It is used to trigger the device to output a wave, and is accepted only when the trigger mode is set to Trigger, Gate or Burst, and the trigger source is set to BUS.

Type: Common Command

Syntax: *TRG

4.12.6 Stored Settings Commands

a) ***RCL** - Recall instrument state

This command is used to restore the state of the device to that stored in the specified memory location.

Arguments
 Type <NRf>
 Range 0 to 49. Non integer values are rounded before execution

Type: Common Command
 Syntax: *RCL<ws><NRf>
 Example: *RCL 0 (Recall default state)
 *RCL 49

Stored setting location 49 stores the last instrument setting before power down.

b) *SAV - Save instrument state

This command is used to store the current instrument state in the specified memory location.

Arguments
 Type: <NRf>
 Range: 1 to 49. Non integer values are rounded before execution
 Type: Common Command
 Syntax: *SAV<ws><NRf>
 Example: *SAV 25

Stored setting location 0 stores the factory defaults, and is a read-only location. Location 50 stores a copy of the current instrument setting, and it, too, is read-only.

4.13 Instrument Control Commands

Instrument control commands are grouped into logical subsystems according to the SCPI instrument model. They can be used when interfacing with GPIB or RS-232. The commands are comprised of mnemonics indicating the subsystem to which the command belongs, and the hierarchy within that subsystem. When the command is to be referred to the Root node, it should be prefixed with a colon (:). Mnemonics appearing in square brackets [...] are optional. The '|' character is used to denote a choice of specifications. The '<ws>' is used to denote a white space character.

4.13.1 SOURce Subsystem

The Source Subsystem controls the frequency, voltage, amplitude modulation and clock source. The command structure is as follows:

```
:SOURce
  :FREQuency
    [:CW|:FIXed] <numeric value>
  :PRATe <numeric value>
  :FUNCTion
    [:SHAPe] SINusoid|SQUare|TRIangle||ARBItrary||PULSe
  : DCYClE ] <numeric value>
  :VOLTagE
    [:AC]
      [:LEVel]
        [:IMMediate]
          [:AMPLitude] <numeric value>
          :OFFSet <numeric value>
  :REFerence
    [:SOURCE] INTernal |EXTernal
```

```

:AM
  [:STATe] <Boolean>
    :DEPTH <numeric value>
    :SHAPE SINusoid|SQUare|TRIangle
    :FREQuency <numeric value>
    :SOURce INTernal |EXTernal

:FM
  [:STATe] <Boolean>
    :DEVIation <numeric value>
    :SHAPE SINusoid|SQUare|TRIangle
    :FREQuency <numeric value>
    :SOURce INTernal |EXTernal

:FSK
  [:STATe] <Boolean>
    :LOWFrequency <numeric value>
    :HIFrequency <numeric value>
    :RATE <numeric value>
    :SOURce INTernal |EXTernal

:SWEEP
  :STATe <Boolean>
    :SPACing <LIN|LOG>
    :TIME <numeric value>
    :STARt <numeric value>
    :STOP <numeric value>

:PHAsE
  [:ADjust] <numeric value >

:PULSe
  :PERiod <numeric value >
  :WIDth <numeric value >
  :EDGE <numeric value >
  :RISe <numeric value >
  :FALl <numeric value >

```

Note: For model 4078, nothing changes in the commands above to control channel 1. But for channel 2, change :SOURce to :SOUR2. For example, to change channel 2 to SINE function, send the command: SOUR2:FUNC SIN.

4.13.1.1 Frequency

```
:SOURce:FREQuency <frequency>
```

The frequency command controls the frequency of the output waveform.

Arguments

Type: Numeric.
 Units: MHz, KHz, Hz (default)
 Range: Dependent on the Point Rate and Wavelength.
 $F_{max} = 1/(10nS * Wavelength)$
 $F_{min} = 1/(100S * Wavelength)$

Rounding: The value is rounded to 4 digits.

Command Type: Setting or Query

Setting

Syntax: [:SOURce]:FREQuency[:CW]<ws><frequency>[units]
 [:SOURce]:FREQuency<ws>MINimum|MAXimum

Examples: :FREQ 5KHZ
 :FREQ 5E3
 :FREQ MAXIMUM
 :FREQ MIN

Query
Syntax: [:SOURce]:FREQUency[:CW]?[<ws>MAXimum|MINimum]
Examples: :FREQ?
:FREQ? MAX
Response: NR3

Considerations:

- 1) The MIN | MAX arguments should be used only in a Program Message that does NOT contain Program Message Units specifying Arbitrary Point Rate or Wavelength, since the MAXimum or MINimum value is calculated at the time the command is parsed.
- 2) The MIN and MAX arguments refer to currently settable minimum or maximum.
- 3) FIXed is alias for CW.

4.13.1.2 Amplitude

:SOURce:VOLTage[:AMPLitude] <p-p amplitude>

The amplitude command is used to set the peak-to-peak amplitude of the output waveform. Note that the amplitude and the offset are limited by the relation

$$\text{Peak Amplitude} + |\text{Offset}| \leq 5\text{V}$$

Arguments

Type: Numeric
Units: V, mV
Range: 10mV to 10V
Rounding: 1mV from 10mV to 999mV. 10mV from 1V to 10V.
Command Type: Setting or Query

Setting

Syntax: [:SOURce]:VOLTage:AMPLitude<ws><amplitude>[units]
[:SOURce]:VOLTage:AMPLitude<ws>MINimum|MAXimum

Examples: :VOLT:AMPL 2.5
:VOLT:AMPL 2.5V
:VOLT:AMPL MAX

Query

Syntax: [:SOURce]:VOLTage:AMPLitude?
[<ws>MINimum|MAXimum]

Examples: :VOLT:AMPL?
:VOLT:AMPL? MAX

Response: NR2

Considerations:

- 1) The MAXimum amplitude is dependent on the offset.
- 2) The MAX and MIN arguments should not be used in a program message containing an OFFSet command, since these values are evaluated during parsing, based on the current value of the offset.

4.13.1.3 Offset

:SOURce:VOLTage:OFFSet <offset>

The offset command is used to set the DC offset of the output waveform. Note that the amplitude and the offset are limited by the relation

$$\text{Peak Amplitude} + |\text{Offset}| \leq 5\text{V}$$

Arguments

Type: Numeric
Units: V, mV
Range: 10mV to 4.99V
Rounding: to 10mV
Command Type: Setting or Query

Setting

Syntax: [:SOURce]:VOLTage:OFFSet<ws><offset>[units]
[:SOURce]:VOLTage:OFFSet<ws>MINimum|MAXimum
Examples: :VOLT:OFFS 2.5
:VOLT:OFFS 2.5V
:VOLT:OFFS MAX

Query

Syntax: [:SOURce]:VOLTage:OFFSet? [<ws>MINimum|MAXimum]
Examples: :VOLT:OFFS?
:VOLT:OFFS? MAX

Response: NR2

Considerations:

- 1) The MAXimum offset is dependent on the amplitude.
- 2) The MAX and MIN arguments should not be used in a program message containing an AMPLitude command, since these values are evaluated during parsing, based on the current value of the amplitude.

4.13.1.4 Clock Reference Source

:SOURce:REFerence:SOURce <clock source>

This command is used to select the source of the arbitrary waveform clock. This clock sets the arbitrary waveform point rate.

Arguments

Type: Character
Options: INTernal, EXTernal
Command Type: Setting or Query

Setting

Syntax: [:SOURce]: REFerence
:SOURce<ws><option>
Examples: :REF:SOUR INT
:REF:SOUR EXT

Query

Syntax: [:SOURce]: REFerence :SOURce?
Response: INT|EXT

4.13.1.5 Function

:SOURce:FUNction [:SHAPE]

The function command is used to set the type of waveform to be generated by the instrument.

Command Type: Setting or Query

Setting

Syntax: [:SOURce]:FUNction[:SHAPE]<WS><OPTION>
Examples: : FUNC SIN
:FUNC ARB

Query

Syntax: [:SOURce]:FUNction[:SHAPE]?
Examples: :FUNC?
Response: SIN|TRI|SQU|ARB|PUL
Considerations:

The following functions are available:

Sinusoid, Square, TRIangle, ARBbitrary, PULse

4.13.1.6 Point Rate

:SOURce:PRATe <point rate>

This command is used to set the point rate. It is coupled with the frequency of the waveform by the relation

$$\text{Frequency} = 1/(\text{Point Rate} * \text{Wavelength})$$

Thus changing the point rate will result in a change in frequency.

Arguments

Type: Numeric
Units: S, mS, uS, nS
Range: 10nS to 100S
Rounding: To 4 digits
Command Type: Setting or Query

Setting

Syntax: :SOURce:PRATe<ws><point rate>[units]
:SOURce:PRATe<ws>MINimum|MAXimum

Examples: :ARB:PRAT 500NS

Query

Syntax: :ARBbitrary:PRATe? [<ws>MINimum|MAXimum]
Response: NR3

4.13.1.7 AM modulation

The following sections control the AM modulation:

4.13.1.7.1 AM STATE

This command activates or deactivates AM modulation:

Arguments

Type: Boolean
Command Type: Setting or Query
Setting
Syntax: [: SOURce:]AM [:STATe]<ws>ON|1|OFF|0
Examples: : SOURce:AM :STAT ON
AM OFF

Query

Syntax: [:SOURce:]AM[:STATe]?
Response: 0|1

4.13.1.7.2 AM DEPTH

This command sets the AM modulation depth in %

Arguments

Type: Numeric
Units: none (implied %)
Range: 0 to 100

Rounding: to integer
Command Type: Setting or Query
Setting
Syntax: :SOURce:AM:DEPTh<ws><percent depth>
:SOURce:AM:DEPTTh<ws>MINimum|MAXimum
Examples: AM:DEPTTh 50
Query
Syntax: AM:DEPTTh? [<ws>MINimum|MAXimum]
Response: NR3

4.13.1.7.3 AM SHAPe

This command selects the AM modulating waveform shape

Arguments
Type: Character
Options: SINusoid, TRIangle, SQUare
Command Type: Setting or Query
Setting
Syntax: [:SOURce:]AM:SHAPe<ws><SIN|TRI|SQU>
Examples: [:SOURce:]AM:SHPE SIN
AM:SHAPE TRI
Query
Syntax: [:SOURce:]AM:SHAPe?
Response: SIN|TRI|SQU

4.13.1.7.4 AM FREQUency

This command sets the AM modulating waveform frequency

Arguments
Type: Numeric.
Units: MHz, KHz, Hz (default)
Range: Fmax = 20 KHz
Fmin = 0.01 Hz
Rounding: The value is rounded to 4 digits.
Command Type: Setting or Query
Setting
Syntax: [:SOURce:]AM:FREQUency<ws><frequency>[units]
[:SOURce:]AM:FREQUency<ws>MINimum|MAXimum
Examples: AM:FREQ 5KHZ
AM:FREQ 5E3
AM:FREQ MAXIMUM
AM:FREQ MIN
Query
Syntax: [:SOURce:]AM:FREQUency? [<ws>MAXimum|MINimum]
Examples: AM:FREQ?
AM:FREQ? MAX
Response: NR3

4.13.1.7.5 AM SOURce

This command selects the AM modulation source as either internal (then the above settings are effective) or external (and then the external waveform determines depth, shape and frequency of modulation).

Arguments
Type: Character
Options: INTernal, EXTernal
Command Type: Setting or Query
Setting
Syntax: [:SOURce:] AM:SOURce<ws><INT|EXT>

Examples: AM:SOUR INT
 AM:SOUR EXT

Query
 Syntax: [:SOURce]:AM:SOURce?
 Response: INT|EXT

4.13.1.8 FM modulation

The following commands control the FM modulation:

4.13.1.8.1 FM STATe

This command activates or deactivates FM modulation:

Arguments
 Type: Boolean
 Command Type: Setting or Query
 Setting
 Syntax: [:SOURce]:FM[:STATe]<ws>ON|1|OFF|0
 Examples: FM:STAT ON
 FM OFF

Query
 Syntax: [:SOURce]:FM[:STATe]?
 Response: 0|1

4.13.1.8.2 FM DEVIation

This command sets the FM modulation deviation

Arguments
 Type: Numeric.
 Units: MHz, KHz, Hz (default)
 Range: Dependent on the carrier frequency.
 Fmax = carrier frequency
 Fmin = 10 uHz

Rounding: The value is rounded to 4 digits.
 Command Type: Setting or Query
 Setting
 Syntax: [:SOURce]:FM:DEVIation<ws><frequency>[units]
 [:SOURce]:FM:DEVIation<ws>MINimum|MAXimum
 Examples: FM:DEV 5KHZ
 FM:DEV 5E3
 FM:DEV MAXIMUM
 FM:DEV MIN

Query
 Syntax: [:SOURce]:FM:DEVIation? [<ws>MAXimum|MINimum]
 Examples: FM:DEV?
 FM:DEV? MAX
 Response: NR3

4.13.1.8.3 FM SHAPe

This command selects the FM modulating waveform shape

Arguments
 Type: Character
 Options: SINusoid, TRIangle, SQUare
 Command Type: Setting or Query
 Setting
 Syntax: [:SOURce]:FM:SHAPe<ws><SIN|TRI|SQU>
 Examples: [:SOURce]:FM:SHPE SIN
 FM:SHAPE TRI

Query

Syntax: [:SOURce:]FM:SHAPE?
Response: SIN|TRI|SQU

4.13.1.8.4 FM FREQuency

This command sets the FM modulating waveform frequency

Arguments

Type: Numeric.
Units: MHz, KHz, Hz (default)
Range: Fmax = 20 KHz
Fmin = 0.01 Hz
Rounding: The value is rounded to 4 digits.
Command Type: Setting or Query

Setting

Syntax: [:SOURce:]FM:FREQuency<ws><frequency>[units]
[:SOURce:]FM:FREQuency<ws>MINimum|MAXimum

Examples: FM:FREQ 5KHZ
FM:FREQ 5E3
FM:FREQ MAXIMUM
FM:FREQ MIN

Query

Syntax: [:SOURce:]FM:FREQuency? [<ws>MAXimum|MINimum]

Examples: FM:FREQ?
FM:FREQ? MAX

Response: NR3

4.13.1.8.5 FM SOURce

This command selects the FM modulation source as either internal (then the above settings are effective) or external (and then the external waveform determines deviation, shape and frequency of modulation).

Arguments

Type: Character
Options: INTernal, EXTernal
Command Type: Setting or Query

Setting

Syntax: [:SOURce:] FM:SOURce<ws><option>

Examples: FM:SOUR INT
FM:SOUR EXT

Query

Syntax: [:SOURce:]FM:SOURce?

Response: INT|EXT

4.13.1.9 FSK modulation

The following commands control the FSK modulation:

4.13.1.9.1 FSK STATe

This command activates or deactivates FSK modulation:Arguments

Type: Boolean
Command Type: Setting or Query

Setting

Syntax: [:SOURce:]FSK[:STATe]<ws>ON|1|OFF|0

Examples: FSK:STAT ON
FM OFF

Query

Syntax: [:SOURce:]FSK[:STATe]?

Response: 0|1

4.13.1.9.2 FSK LOWFrequency

This command sets the lower of the two frequencies used in FSK modulation.

Arguments

Type: Numeric.
Units: MHz, KHz, Hz (default)
Range: The whole frequency range of the current function.
Rounding: The value is rounded to 4 digits.
Command Type: Setting or Query

Setting

Syntax: [:SOURce:]FSK:LOWFrequency<ws><frequency>[units]
[:SOURce:]FSK:LOWFrequency<ws>MINimum|MAXimum

Examples: FSK:LOWFrequency 5KHZ
FSK:LOWF 5E3
FSK:LOWF MAXIMUM
FSK:LOWF MIN

Query

Syntax: [:SOURce:]FSK:LOWFrequency? [<ws>MAXimum|MINimum]

Examples: FSK:LOWF?
FSK:LOWF? MAX

Response: NR3

4.13.1.9.3 FSK HIFrequency

This command sets the higher of the two frequencies used in FSK modulation.

Arguments

Type: Numeric.
Units: MHz, KHz, Hz (default)
Range: The whole frequency range of the current function.
Rounding: The value is rounded to 4 digits.
Command Type: Setting or Query

Setting

Syntax: [:SOURce:]FSK:HIFrequency<ws><frequency>[units]
[:SOURce:]FSK:HIFrequency<ws>MINimum|MAXimum

Examples: FSK:HIFrequency 5KHZ
FSK:HIF 5E3
FSK:HIF MAXIMUM
FSK:HIF MIN

Query

Syntax: [:SOURce:]FSK:HIFrequency? [<ws>MAXimum|MINimum]

Examples: FSK:HIF?
FSK:HIF? MAX

Response: NR3

4.13.1.9.4 FSK RATE

This command sets the rate of switching between the two frequencies of the modulation.

Arguments

Type: Numeric.
Units: MHz, KHz, Hz (default)
Range: Fmax = 1MHz
Fmin = 0.01Hz
Rounding: The value is rounded to 4 digits.
Command Type: Setting or Query

Setting

Syntax: [:SOURce:]FSK:RATE<ws><frequency>[units]
[:SOURce:]FSK:RATE <ws>MINimum|MAXimum

Examples: FSK:RATE 5KHZ
 FSK:RATE 5E3
 FSK:RATE MAXIMUM
 FSK:RATE MIN

Query
 Syntax: [:SOURce]:FSK:RATE ?[<ws>MAXimum|MINimum]
 Examples: FSK:RATE ?
 FSK:RATE ? MAX
 Response: NR3

4.13.1.9.5 FSK SOURce

This command selects the FSK modulation source as either internal (then the above settings are effective) or external (and then the external waveform determines the frequency of modulation).

Arguments
 Type: Character
 Options: INTernal, EXTernal
 Command Type: Setting or Query
 Setting
 Syntax: [:SOURce:] FSK:SOURce<ws><INT|EXT>
 Examples: FSK:SOUR INT
 FSK:SOUR EXT

Query
 Syntax: [:SOURce]:FSK:SOURce?
 Response: INT|EXT

4.13.1.10 Sweep control

The following commands control the sweep functionality:

4.13.1.10.1 Sweep STATE

This command activates or deactivates sweep:

Arguments
 Type: Boolean
 Command Type: Setting or Query
 Setting
 Syntax: [:SOURce:]SWEEP[:STATe]<ws>ON|1|OFF|0
 Examples: SWEEP:STAT ON
 SWEEP OFF

Query
 Syntax: [:SOURce:]SWEEP[:STATe]?
 Response: 0|1

4.13.1.10.2 Sweep SPACing

This command sets the sweep spacing as either LINear or LOGarithmic:

Arguments
 Type: Character
 Options: Linear, Logarithmic
 Command Type: Setting or Query
 Setting
 Syntax: [:SOURce:] SWEEP:SPACing<ws><LIN|LOG>
 Examples: [:SOURce:] SWEEP:SPACing LIN
 SWEEP:SPAC LOG

Query
 Syntax: [:SOURce:] SWEEP:SPACing ?
 Response: LIN|LOG

4.13.1.10.3 Sweep TIME

This command sets the time for one complete sweep:

Arguments
Type: Numeric
Units: S, mS, uS, nS
Range: 20mS to 500S
Rounding: to 4 digits
Command Type: Setting or Query
Setting
Syntax: [:SOURce:]SWEEP:TIME<ws><time>[units]
[:SOURce:]SWEEP:TIME<ws>MINimum|MAXimum
Examples: SWEEP:TIME 50MS
Query
Syntax: [:SOURce:]SWEEP:TIME? [<ws>MINimum|MAXimum]
Response: NR3

4.13.1.10.4 Sweep START

This command sets the start frequency of the sweep:

Arguments
Type: Numeric.
Units: MHz, KHz, Hz (default)
Range: Dependent on the frequency range of the current function.
Rounding: The value is rounded to 4 digits.
Command Type: Setting or Query
Setting
Syntax: [:SOURce:]SWEEP:START<ws><frequency>[units]
[:SOURce:]SWEEP:START<ws>MINimum|MAXimum
Examples: SWEEP:START 5KHZ
SWEEP:START 5E3
SWEEP:START MAXIMUM
SWEEP:START MIN
Query
Syntax: [:SOURce:]SWEEP:START? [<ws>MAXimum|MINimum]
Examples: SWEEP:START ?
SWEEP:START ? MAX
Response: NR3

4.13.1.10.5 Sweep STOP

This command sets the stop frequency of the sweep:

Arguments
Type: Numeric.
Units: MHz, KHz, Hz (default)
Range: Dependent on the frequency range of the current function.
Rounding: The value is rounded to 4 digits.
Command Type: Setting or Query
Setting
Syntax: [:SOURce:]SWEEP:STOP<ws><frequency>[units]
[:SOURce:]SWEEP:STOP<ws>MINimum|MAXimum
Examples: SWEEP:STOP 5KHZ
SWEEP:STOP 5E3
SWEEP:STOP MAXIMUM
SWEEP:STOP MIN

Query
 Syntax: [:SOURce:]SWEEP:STOP? [<ws>MAXimum|MINimum]
 Examples: SWEEP:STOP ?
 SWEEP:STOP ? MAX
 Response: NR3

4.13.1.11 PHASe adjust

This command controls the phase adjustment

Arguments
 Type: Numeric
 Units: one (degrees implied)
 Range: -180 to +180 (other values converted to this range)
 Rounding: to integer
 Command Type: Setting or Query
 Setting
 Syntax: [:SOURce:]PHASe<ws><phase>
 [:SOURce:]PHASe<ws>MINimum|MAXimum
 Examples: [:SOURce:]PHASe 500NS
 Query
 Syntax: [:SOURce:]PHASe? [<ws>MINimum|MAXimum]
 Response: NR3

4.13.1.12 PULSe setting

The following commands control the pulse function:

Note that $width + 0.6 * (rise + fall) < period$ in order to have valid values. Width < Period – 10 ns

4.13.1.12.1 PULSe PERiod

This command sets the pulse period to the specified value.

NOTE: This also sets the pulse frequency.

Arguments
 Type: Numeric
 Units: S, mS, uS, nS
 Range: 100nS-1000S
 Rounding: 4 digits
 Command Type: Setting or Query
 Setting
 Syntax: [:SOURce:] PULse: PERiod <ws><value>
 [:SOURce:] PULse: PERiod <ws>MINimum|MAXimum
 Examples: [:SOURce:] PULse: PERiod 500NS
 Query
 Syntax: [:SOURce:] PULse: PERiod? [<ws>MINimum|MAXimum]
 Response: NR3

4.13.1.12.2 PULSe WIDTH

This command pulse width to the specified value.

Arguments
 Type: Numeric
 Units: S, mS, uS, nS
 Range: 20 nS minimum; maximum defined by period and transition (see note above)
 Rounding: 4 digits
 Command Type: Setting or Query
 Setting
 Syntax: [:SOURce:]PULse:WIDTH<ws>< value >
 [:SOURce:] PULse:WIDTH <ws>MINimum|MAXimum
 Examples: [:SOURce:] PULse:WIDTH 500NS
 Query

Syntax: [:SOURce:] PULse: WIDTH? [<ws>MINimum|MAXimum]
Response: NR3

4.13.1.12.3 PULse EDGe

This command sets both rising and falling edge of the pulse to the specified value.

Arguments

Type: Numeric
Units: S, mS, uS, nS
Range: 100 nS minimum; maximum defined by period and width (see note above)
Rounding: 4 digits
Command Type: Setting or Query

Setting

Syntax: [:SOURce:] PULse:EDGe <ws>< value >
[:SOURce:] PULse:EDGe <ws>MINimum|MAXimum

Examples: [:SOURce:] PULse:EDGe 500NS

Query

Syntax: [:SOURce:] PULse:EDGe? [<ws>MINimum|MAXimum]
Response: NR3

4.13.1.12.4 PULse RISE

This command sets rising edge of the pulse to the specified value.

Arguments

Type: Numeric
Units: S, mS, uS, nS
Range: 100 nS minimum; maximum defined by period and width (see note above)
Rounding: 4 digits
Command Type: Setting or Query

Setting

Syntax: [:SOURce:] PULse:RISe <ws><phase>
[:SOURce:] PULse:RISe <ws>MINimum|MAXimum

Examples: [:SOURce:] PULse:RISe 500NS

Query

Syntax: [:SOURce:] PULse:RISe? [<ws>MINimum|MAXimum]
Response: NR3

4.13.1.12.5 PULse FALl

This command sets falling edge of the pulse to the specified value.

Arguments

Type: Numeric
Units: S, mS, uS, nS
Range: 100 nS minimum; maximum defined by period and width (see note above)
Rounding: 4 digits
Command Type: Setting or Query

Setting

Syntax: [:SOURce:] PULse:FALl <ws><phase>
[:SOURce:] PULse:FALl <ws>MINimum|MAXimum

Examples: [:SOURce:] PULse:FALl 500NS

Query

Syntax: [:SOURce:] PULse:FALl? [<ws>MINimum|MAXimum]
Response: NR3

4.13.1.13 Duty Cycle

:SOURce:DCYClE <duty cycle value>

This command is used to set the duty-cycle of the square wave or the symmetry of triangular wave. The value is given in percent .

Arguments

Type: Numeric
Units: None (percent implied)
Range: 20 to 80
Rounding: to integer
Command Type: Setting or Query

Setting

Syntax: :SOURce: DCYClE <ws><duty cycle value>
:SOURce: DCYClE <ws>MINimum|MAXimum

Query

Syntax: :SOURce: DCYClE? [<ws>MINimum|MAXimum]
Response: NR3

4.13.2 OUTPut Subsystem

The Output Subsystem controls characteristics of the source's output. Included in this subsystem are the State and Summing commands. The command structure is as follows:

:OUTPut
[:STATe] <Boolean>
:SUMming <Boolean>

Note: For model 4078, nothing changes in the commands above to control channel 1. But for channel 2, change :OUTP to :OUTP2. For example, to change channel 2 output to ON, send the command: OUTP2 ON or OUTP2 1.

4.13.2.1 Output State

:OUTPut [:STATe] <state 0,1>

This command controls whether the output is ON or OFF.

Arguments

Type: Boolean
Command Type: Setting or Query

Setting

Syntax: :OUTPut[:STATe]<ws>ON|1|OFF|0
Examples: :OUTP:STAT ON
:OUTP OFF

Query

Syntax: :OUTPut[:STATe]?
Response: 0|1

4.13.3 Trigger Subsystem

The Trigger Subsystem is used to control the waveform triggering. The command structure is as follows:

:TRIGger
:MODE CONTinuous|TRIGger|GATE|BURSt
:BURSt <numeric value>

:SOURCE <MANual|INTernal|EXTernal|BUS
:TIMer <numeric value>

Note: For model 4078, nothing changes in the commands above to control channel 1. But for channel 2, change :TRIG to :TRIG2. For example, to change channel 2 mode to gate, send the command: TRIG2:MODE GATE.

4.13.3.1 Trigger Mode

:TRIGger:MODE <trigger mode>

This command is used to set the trigger mode. It is not a standard SCPI command.

Arguments
Type: Character
Options: CONTinuous
TRIGger
GATE
BURSt
Command Type: Setting or Query
Setting
Syntax: :TRIGger:MODE<ws><option>
Examples: :TRIG:MODE CONT
:TRIG:MODE BURS
Query
Syntax: :TRIGger:MODE?
Response: CONT|TRIG|GATE|BURS

4.13.3.2 Trigger Source

:TRIGger:SOURce <trigger source>

This command is used to select the trigger source, for use in the Trigger, Gate and Burst trigger modes.

Arguments
Type: Character
Options: MANual - Front panel MAN key
BUS - GPIB trigger (GET or *TRG)
INTernal - Internal trigger
EXTernal - External trigger
Command Type: Setting or Query
Setting
Syntax: :TRIGger:SOURce<ws><option>
Examples: :TRIG:SOUR BUS
:TRIG:SOUR INT
Query
Syntax: :TRIGger:SOURce?
Response: MAN|BUS|INT|EXT

4.13.3.3 Burst Count

:TRIGger:BURSt <burst count>

Used to set the number of cycles to be output in the BURST mode. It is not a standard SCPI command.

Arguments
 Type: Numeric
 Range: 1 to 999999
 Rounding: to integer value
 Command Type: Setting or Query
 Setting
 Syntax :TRIGger:BURSt<ws><value>
 Examples :TRIG:BURS 100
 :TRIG:BURS MAXIMUM

Query
 Syntax: :TRIGger:BURSt? [<ws>MAXimum|MINimum]
 Response: NR1
 Examples: :TRIG:BURST?
 :TRIG:BURS? MAX

4.13.3.4 Internal Trigger Rate

:TRIGger:TIMer <trigger rate>

Sets the rate of the internal trigger.

Arguments
 Type: Numeric
 Units: S, mS, uS, nS
 Range: 1E-6S to 100S
 Rounding: to 4 digits
 Command Type: Setting or Query
 Setting
 Syntax: :TRIGger:TIMer<ws><value>[units]
 :TRIGger:TIMer<ws>MINimum|MAXimum
 Examples: :TRIG:TIM 10E-6
 :TRIG:TIM MIN

Query
 Syntax: :TRIGger:TIMer? [<ws>MINimum|MAXimum]
 Response: NR3
 Examples: :TRIG:TIM?
 :TRIG:TIM? MIN

4.13.4 Arbitrary Subsystem

The Arbitrary subsystem is not part of the SCPI standard. It was developed to suit the needs of the instrument. Within this subsystem are commands to:

- 1) control the point rate, start address, wavelength, marker address, and synchronization pulse address;
- 2) set values of the arbitrary waveform, either discretely or using predefined, copy or draw functions;
- 3) protect an area of waveform memory;
- 4) set the state of the automatic update and increment features;
- 5) update the waveform.

The following shows the structure of the ARBitary subsystem:

:ARBitary
 :PRATe <numeric value>

:ADDRESS <numeric value>
 :DATA <numeric value>|<arbitrary block>
 :DRAW <numeric value>,<numeric value>
 :CLEAR <numeric value>,<numeric value>
 :COPY <NRf>,<NRf>,<NRf>
 :PROTECT
 [:RANGE] <numeric value>,<numeric value>
 :STATE <Boolean>
 :PREDEFINED <shape>,<start address>,<length>,<scale>
 :START <numeric value>
 :LENGTH <numeric value>
 :MARKER
 [:ADDRESS] <numeric value>
 :STATE <Boolean>
 :LENGTH <numeric value>
 :SAVE

Note: For model 4078, nothing changes in the commands above to control channel 1. But for channel 2, change :ARB to :ARB2. For example, to change channel 2 to ARB mode with a predefined square wave from address 1 with length of 2000 and scale factor of 50%, first send the command for channel to go into arbitrary waveform mode (SOUR2:FUNC ARB), then send the command: ARB2:PRED SQU,1,2000,50.

When sending or receiving large waveforms with any software or custom programmed applications, please allow AT LEAST 15 seconds or more after the process is completed on the PC before pressing any front panel keys to return to local mode. The instrument requires this extra time to completely receive or send the waveform.

4.13.4.1 Point Rate

ARBITRARY:PRATE <point rate>

This command is used to set the point rate. It is coupled with the frequency of the waveform by the relation:

$$\text{Frequency} = 1/(\text{Point Rate} * \text{Wavelength})$$

Thus changing the point rate will result in a change in frequency.

Arguments

Type:	Numeric
Units:	S, mS, uS, nS
Range:	10nS to 100S
Rounding:	to 4 digits
Command Type:	Setting or Query
Setting	
Syntax:	:ARBITRARY:PRATE<ws><point rate>[units] :ARBITRARY:PRATE<ws>MINimum MAXimum
Examples:	:ARB:PRAT 100NS
Query	
Syntax:	:ARBITRARY:PRATE? [<ws>MINimum MAXimum]
Response:	NR3

4.13.4.2 Address

:ARBITRARY:ADDRESS <address>

This command sets the current address of the waveform. It is used to determine where arbitrary data are to be written. Use this command when querying data points using ARB:DATA? After generating data points.

Arguments

Type: Numeric
Range: 1 to 400,000
Rounding: to integer value
Command Type: Setting or Query
Setting
Syntax: :ARbitrary:ADDRess<ws><address>
:ARbitrary:ADDRess<ws>MINimum|MAXimum
Examples: :ARB:ADDR 100
Query
Syntax: :ARbitrary:ADDRess? [<ws>MINimum|MAXimum]
Response: NR1

4.13.4.3 Data

:ARbitrary:DATA <data>

This command is used to set the values of the waveform.

Arguments

Type: Numeric. Definite form arbitrary block. Indefinite form arbitrary block
Numeric Range: -8191 to 8191 ASCII
Rounding: to integer value
Binary Range: 001H to 3FFFH BINARY
Command Type: Setting or Query
Setting Syntax
Numeric: :ARbitrary:DATA<ws><numeric>{[,<numeric>]}
Example :ARB:DATA 100,200,1000,2000,-2000
Arbitrary Block: :ARbitrary:DATA<ws>#<arb block data>

Refer to section 4.16

Examples

Definite Form: :ARB:DATA #14\x8\x64\x8\xC8
‘\x’ indicates that the values are Hexadecimal.

Indefinite: :ARB:DATA #0\x8\x64\x8\xC8\xa^EOI

Query

Syntax: :ARbitrary:DATA?<ws><number of points>, BINary|ASCii

Note: The <number of points> that the query returns starts from the current address.
For example, if <number of points> is set as 5, and address is 1000, it will return data point values in address 1000, 1001, 1002, 1003, and 1004. The address will then point to 1005 after the query.

Response: Using the BINary option, data are returned in the Indefinite arbitrary block form.
Using the ASCii option, data are returned in the decimal numeric form.

Considerations:

- 1) Data cannot be written to protected memory.
- 2) In binary form, each data point consists of two bytes.
- 3) The high byte must precede the low byte.
- 4) When using ARB:DATA to generate data points, the address will increment based on the number of points set. For example, suppose the current address is 1. The command ARB:DATA 100,200,300 is sent. The address becomes 4 after this command. To query these data points immediately using ARB:DATA? command as described above, the address must be reset back to 1 using ARB:ADDR command prior to the query.

4.13.4.4 Line Draw

:ARbitrary:DRAW <start address>,<end address>

This command is used to generate a straight line between two points in the arbitrary waveform memory.

Arguments

Type: Numeric.
Range: 1 to 400,000
Rounding: to integer value
Command Type: Setting only

Setting

Syntax: :ARbitrary:DRAW<ws><start address>,<end address>
Example: :ARB:DRAW 1,1000

Considerations:

- 1) The value of the data at the start and end points must first be set by the user, using the :ARB:DATA command. For example, suppose a line needs to be drawn from address 1000 to 2000 with data point values 4000 and 8191 respectively like below:

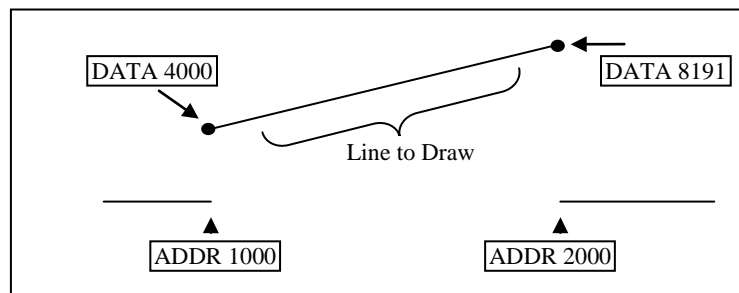

To do this,

1. Set address to 1000 by sending ARB:ADDR 1000
 2. Set data to 4000 by sending ARB:DATA 4000
 3. Set address to 2000 by sending ARB:ADDR 2000
 4. Set data to 8191 by sending ARB:DATA 8191
 5. Then, use ARB:DRAW 1000,4000 to get the above line.
- 2) The range of the straight line cannot overlap with protected memory.
 - 3) The end address must be greater than the start address.

4.13.4.5 Clear

:ARbitrary:CLEar <start address>,<end address>

This command is used to clear all or a portion of waveform memory. The memory is the set to the value zero.

Arguments

Type: Numeric.
Numeric Range: 1 to 400,000
Rounding: to integer value
Command Type: Setting only.

Setting

Syntax: :ARbitrary:CLEar<ws><start address>,<end address>
Examples: :ARB:CLE 1,1000

Considerations:

- 1) The clear range cannot overlap with protected memory.

- 2) The end address must be greater than the start address.

4.13.4.6 Copy

:ARbitrary:COpy <start address>,<length>,<destination address>

This command is used to copy a section of the waveform to a different location in waveform memory.

Arguments

Type: NRf

Range: 1 to 400,000

Rounding: to integer value

Command Type: Setting only

Setting

Syntax: :ARbitrary:COpy<ws><start>,<length>,<destination>

Example: :ARB:COpy 1,1000,1001

Considerations:

- 1) The destination range cannot overlap with protected memory.
- 2) The destination range cannot overlap with the source range.
- 3) The destination end address may not exceed the maximum address:

Destination address + Length - 1 <= 131072

4.13.4.7 Memory Protection Range

:ARbitrary:PROtect [:RANGe] <start address>,<end address>

This command is used to define a range of arbitrary waveform memory to be write-protected. The protection is effective only if the PROtect:STATe is ON.

Arguments

Type: Numeric.

Numeric Range: 1 to 400,000

Rounding: to integer value.

Command Type: Setting or Query

Setting

Syntax: :ARbitrary:PROtect[:RANGe]<ws><start>,<end>

Examples: :ARB:PROT 1,1E3

Query

Syntax: :ARbitrary:PROtect[:RANGe]?

Response: <protect start>,<protect end> in NR1 format.

4.13.4.8 Memory Protection State

:ARbitrary:PROtect:STATe <Boolean>

This command is used to enable or disable arbitrary waveform write-protection.

Arguments

Type: Boolean

Command Type: Setting or Query

Setting

Syntax: :ARbitrary:PROtect:STATe<ws>ON|1|OFF|0

Example: :ARB:PROT:STAT ON
 Query
 Syntax: :ARbitrary:PROTECT:STATE?
 Response: 0|1

4.13.4.9 Predefined Waveforms

:ARB:PRED <shape>,<start address>,<length>,<scale>

This command is used to load the waveform memory with a specific type of waveform.

Arguments

Shape

Type: Character
 Options: SINusoid
 SQUare
 TRIangle
 NOISe (Pseudo-Random Noise)
 ANOise (Noise added to the current waveform)

Start Address

Type: Numeric. The MIN and MAX forms both set the address to 1
 Range: 1 to 400,000
 Rounding: to integer value

Length

Type: Numeric.
 Range
 SIN: 16 to 65,536; divisible by 4
 SQU: 2 to 65,536; divisible by 2
 TRI: 16 to 65,536; divisible by 4
 NOIS: 16 to 65,536
 ANO: 16 to 65,536

Rounding: to integer value.

Scale

Type: Numeric. MIN sets the scale to 1; MAX sets the scale to 100
 Range: 1 to 100 (See considerations)
 Rounding; to integer value.

Command Type: Setting only

Setting

Syntax: :ARbitrary:PREDEFINED<ws> <shape>, <start>, <length>,<scale>

Examples: :ARB:PRED SIN,1,1e3,100

Considerations:

- 1) The start address and the length must meet the specification that. $\text{Start address} + \text{Length} - 1 \leq 131,072$
- 2) The 'scale' refers to the scaling of the waveform as a percentage of full scale. A scale of 100% will, under the correct conditions, generate a waveform whose data values range from -8191 to +8191. These 'correct conditions' are set by the 'offset' value. This offset is the value of the data at the start address, and determines the maximum scale settable. The following table shows the data values required in order to achieve maximum scale.

SHAPE	DATA
SIN	0
SQU	0
TRI	0
NOIS	0

4.13.4.10 Start Address

:ARbitrary:STARt <start address>

This command sets the start address of the waveform to be run.

Arguments

Type: Numeric

Range: 1 to 399,999

Rounding: to integer value

Command Type: Setting or Query

Setting

Syntax: :ARbitrary:STARt<ws><start address>
:ARbitrary:STARt<ws>MINimum|MAXimum

Example: :ARB:STAR 100

Query

Syntax: :ARbitrary:STARt? [<ws>MINimum|MAXimum]

Examples: :ARB:STAR?

:ARB:STAR? MIN

Response: NR1

Considerations: The start address and length must meet the condition:

$$\text{Start Address} + \text{Length} - 1 \leq 400,000$$

4.13.4.11 Wavelength

:ARbitrary:LENGth <length>

This command sets the length of the waveform being run.

Arguments

Type: Numeric

Range: 2 to 400,000

Rounding: to integer value

Command Type: Setting or Query

Setting

Syntax: :ARbitrary:LENGth<ws><length>
:ARbitrary:LENGth<ws>MINimum|MAXimum

Example: :ARB:LENG 1E3

Query

Syntax: :ARbitrary:LENGth? [<ws>MINimum|MAXimum]

Example: :ARB:LENG?

Response: NR1

Considerations: 1) Changing the wavelength will change either the frequency.
2) The minimum wavelength is 2.

4.13.4.12 Marker Address

:ARbitrary:MARKer [:ADDRESS] <marker address>

This command is used to set the address of the marker.

Arguments

Type: Numeric.

Range: 1 to 400,000

Rounding: to integer values

Setting
 Syntax: :ARbitrary:MARKer[:ADDRESS]<ws><marker address>
 Examples: :ARB:MARK 45
 Query
 Syntax: :ARbitrary:MARKer[:ADDRESS]?
 Example: :ARB:MARK?
 Response: Marker address in NR1 format.
 Considerations: The marker is only output if its address is within the range of addresses currently being run.

4.13.4.13 Marker Length

:ARbitrary:MARKer:LENGth <numeric value>

This command is used to set the marker length. The maximum allowed length of marker is 4000. The marker length is specified by appending a numeric value, to the MARKer keyword. Maximum MARKer Length 4000 points

Arguments
 Type: Numeric
 Command Type: Setting or Query
 Setting
 Syntax: :ARbitrary:MARKer:LENGth<ws><length>
 Example: :ARB:MARK:LENG 5
 Query
 Syntax: :ARbitrary:MARKer:LENGth?
 Response: NR1

4.13.4.14 Marker State

:ARbitrary:MARKer:STATe <Boolean>

This command is used to enable or disable the marker.

Arguments
 Type: Boolean
 Command Type: Setting or Query
 Setting
 Syntax: :ARbitrary:MARKer:STATe<ws>ON | OFF (or 1 | 0)0
 Query
 Syntax: :ARbitrary:MARKer:STATe?
 Response: 0|1

4.13.4.15 Save

:ARbitrary:SAVe

This command is used to save all unsaved arbitrary waveform data into non-volatile memory..

Arguments
 Type: none
 Command Type: Setting only
 Setting
 Syntax: :ARbitrary: SAVe

4.13.5 Status Subsystem

This subsystem controls the SCPI-defined status reporting structures, which are the QUESTIONable and OPERATION status registers, and the error/event queue. The OPERATION status registers are mandated by SCPI, and so are implemented, but are not used by the hardware. No status is ever reported through them, and they are not detailed in this manual. The following shows the STATUS structure used:

```
:STATus
  :PRESet
    :QUEue
      [:NEXT]?
      :ENABle
    :QUESTionable
      :CONDition?
      :PTRansition <NRf>
      :NTRansition <NRf>
      :EVENT?
      :ENABle <NRf>
```

4.13.5.1 Status Preset

:STATus:PRESet

This command is used to set certain status values to defined values.

- The OPERATION and QUESTIONable enable registers are cleared.
- The Positive transition filters are set to 32767.
- The Negative transition filters are set to 0.
- Only errors in the range (-440:-100) are enabled to be reported in the event queue.

Command Type: Setting only

Setting

Syntax: :STATus:PRESet

4.13.5.2 Error Queue Read

:STATus:QUEue?

This query returns the first entry in the error queue, and removes that entry from the queue. Its function is identical to that of the :SYSTEM:ERROR? query.

Command Type: Query only

Query

Syntax: :STATus:QUEue[:NEXT]?

Response: <Error number>, "<error description>"

4.13.5.3 Error Queue Enable

:STATus:QUEue:ENABle

This command is used to enable individual errors to be placed in the queue when they occur. Those errors not specified in the :ENABle command are disabled from being reported in the error queue. Errors and events enabled to be reported at power on depends on the Power on Status Clear status (set with the *PSC common command). If PSC is set, the status is cleared on power on, and the range of errors enabled is as set by the STATus:PRESet command, ie -440 to -100. If PSC is cleared, the status is not cleared on power on, and the errors and events enabled are those

that were enabled before the last power down.

Type: Expression

The expression data takes the form

(NRf|<event range>[{|,NRf|<event range>}])

where NRf represents an error number. Entries are rounded to integer values.

An <event range> is defined as

NRf:NRf

The first number in a range MUST be less than the second.

Up to 6 ranges may be specified using one :ENABle command, representing the 6 ranges of errors/events. The ranges are then separated from each other by Program Data Separators (comma). The entire expression must be enclosed in parentheses(...).

Command Type: Setting or Query

Setting

Syntax: :STATus:QUEue:ENABle<ws><expression>

Example: :STAT:QUE:ENAB (-440:-410,-258:-220,402,-110)

Query

Syntax: :STATus:QUEue:ENABle?

Response: (NRf|<event range>[{|,NRf|<event range>}])

4.13.5.4 Questionable Status

The Questionable status data structure is used to alert the user to instrument conditions that affect the signal quality. Two types of conditions are defined in the AWG, and these are:

- 1) Frequency - Trigger rate conflict, and
- 2) Output overload condition.

Each condition is reported separately for each channel. Thus, a total of four conditions may be reported.

The data structure is comprised of five 16-Bit registers. Each bit represents a different status condition. In the AWG, bits 9 and 11 are used as follows:

Bit 9: Frequency - trigger rate conflict.

Bit 11: Output overload.

The existence of these conditions is indicated in the CONDition register. Bit 3 of the status byte is used to indicate the occurrence of a questionable status condition. The conditions cause this bit to be set depending on the values of the other four registers.

The positive transition filter enables a bit in the event register to be set when a condition changes from false to true. The negative transition register enables a bit in the event register to be set when a condition changes from true to false. In order for the bit in the event register to be set, the corresponding bit in the transition register must be set.

Bit 3 in the status byte will be set if a bit in the event register is set while the corresponding bit in the enable register is set.

4.13.5.4.1 Questionable Condition

:STATus:QUEStionable:CONDition?

This query is used to read the condition register.

Command Type: Query only
Query
Syntax: :STATus:QUES:COND?
Response: NR1

4.13.5.4.2 Positive Transition Filter

:STAT:QUES:PTR

This command is used to set and query the value of the positive transition filter.

Arguments
Type: NRf
Range: 0 to 131,072. Non integer arguments are rounded before execution.
Command Type: Setting or Query
Setting
Syntax: :STAT:QUES:PTR<ws><NRf>
Examples: :STAT:QUES:PTR 2048
Query
Syntax: :STAT:QUES:PTR?
Response: NR1

4.13.5.4.3 Negative Transition Filter

:STAT:QUES:NTR

This command is used to set and query the value of the negative transition filter.

Arguments
Type: NRf
Range: 0 to 131,072. Non integer arguments are rounded before execution
Command Type: Setting or Query
Setting
Syntax: :STAT:QUES:NTR<ws><NRf>
Examples: :STAT:QUES:NTR 2048
Query
Syntax: :STAT:QUES:NTR?
Response: NR1

4.13.5.4.4 Event Register

:STAT:QUES:EVENT?

This query is used to read the event register. Reading the register clears it.

Command Type: Query only
Query
Syntax: :STATus:QUES:EVENT?
Response: NR1

4.13.5.4.5 Event Enable Register

:STAT:QUES:ENABLE

This command is used to set and query the value of the enable register.

Arguments

Type: NRf
Range: 0 to 131,072. Non integer arguments are rounded before execution.
Command Type: Setting or Query
Setting
Syntax: :STAT:QUES:ENAB<ws><NRf>
Examples: :STAT:QUES:ENAB 2048
Query
Syntax: :STAT:QUES:ENAB?
Response: NR1

4.13.6 System Subsystem

The SYSTem subsystem collects the functions that are not related to instrument performance. The functions implemented in the AWG are security, GPIB address changing, error queue reading, SCPI version reading, and power-on buffer setting (not SCPI-defined). The command structure is as follows:

```
:SYSTem
:COMMunicate
:GPIB
:ADDRess <numeric value>
:ERRor?
:VERSion?
:SECurity
[:STATe] <Boolean>
:POBuffer <numeric value>
```

4.13.6.1 GPIB Address Change

```
:SYSTem:COMMunicate:GPIB:ADDRess
```

This command is used to set the GPIB address.

Arguments

Type: Numeric
Range: 0 to 31
Rounding: to integer value
Command Type: Setting or Query
Setting
Syntax: :SYSTem:COMMunicate:GPIB:ADDRess<ws><address>[MINimum|MAXimum
Example: :SYST:COMM:GPIB:ADDR 20
Query
Syntax: :SYSTem:COMMunicate:GPIB:ADDRess? [<ws>MINimum|MAXimum]
Response: <address> in NR1 format
Considerations: 1) Setting the address to 31 puts the instrument in the off-bus state.
2) Using the MAX option sets the address to 30, not 31.

Default Power-on is address 9.

4.13.6.2 Error Queue Reading

:SYSTem:ERRor?

This query returns the first entry in the error queue, and removes that entry from the queue. Its function is identical to that of the :STATus:QUEue:NEXT? query.

Command Type: Query only

Query

Syntax: :SYSTem:ERRor?

Response: <Error number>, "<error description>"

4.13.6.3 SCPI Version

:SYSTem:VERSion?

This query is used to read the SCPI version to which the instrument complies.

Command Type: Query only

Query

Syntax: :SYSTem:VERSion?

Response: 1992.0 (NR2 format)

4.13.6.4 Security

:SYSTem:SECurity[:STATe] <Boolean>

This command enables the instrument memory to be cleared. The stored settings and the arbitrary waveform memory are cleared when the Security state is changed from ON to OFF. The instrument state is returned to the factory power-on default.

Arguments

Type: Boolean

Command Type: Setting or Query

Setting

Syntax: :SYSTem:SECurity[:STATe]<ws>ON|1|OFF|0

Examples: :SYST:SEC ON

:SYST:SEC OFF

Query

Syntax: :SYSTem:SECurity[:STATe]?

Response: 0|1

4.13.6.5 Power-on Buffer

:SYSTem:POBuffer <buffer number>

This command is used to set the Power On Buffer setting. The instrument will power-on with the setting stored in that buffer.

Arguments

Type: Numeric

Range: 0 to 49

Rounding: to integer value

Command Type: Setting or Query

Setting

Syntax: :SYSTem:POBuffer<ws><buffer>|MINimum|MAXimum

Example: :SYST:POB 99

Query

Syntax: :SYSTem:POBuffer? [<ws>MINimum|MAXimum]
 Response: Power-on buffer in NR1 format

4.14 IEEE 488.1 Interface Messages

4.14.1 GET - Group Execute Trigger

The GET is used by the AWG as a trigger when it is in either the TRIGGER, GATE or BURST modes, with the trigger source set to BUS. It has the same effect as the *TRG common command.

4.14.2 DCL - Device Clear

In response to the DCL, the AWG does the following:

- a) Clears the input buffer and the output queue.
- b) Resets the Message Processing Functions.

4.14.3 SDC - Selected Device Clear

The response is as for the DCL message, when device is addressed to listen.

4.14.4 LLO - Local Lockout

Sending LLO when device is addressed to listen and controller is asserting the REN line will put the device into "Remote with Lock out" state, locking out the front panel.

4.15 SCPI Command Tree

4.15.1 Root Node

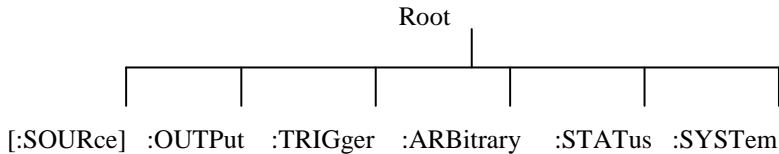

4.15.2 :SOURce Subsystem

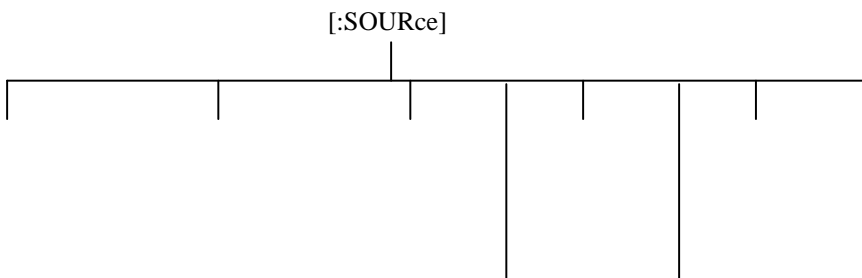

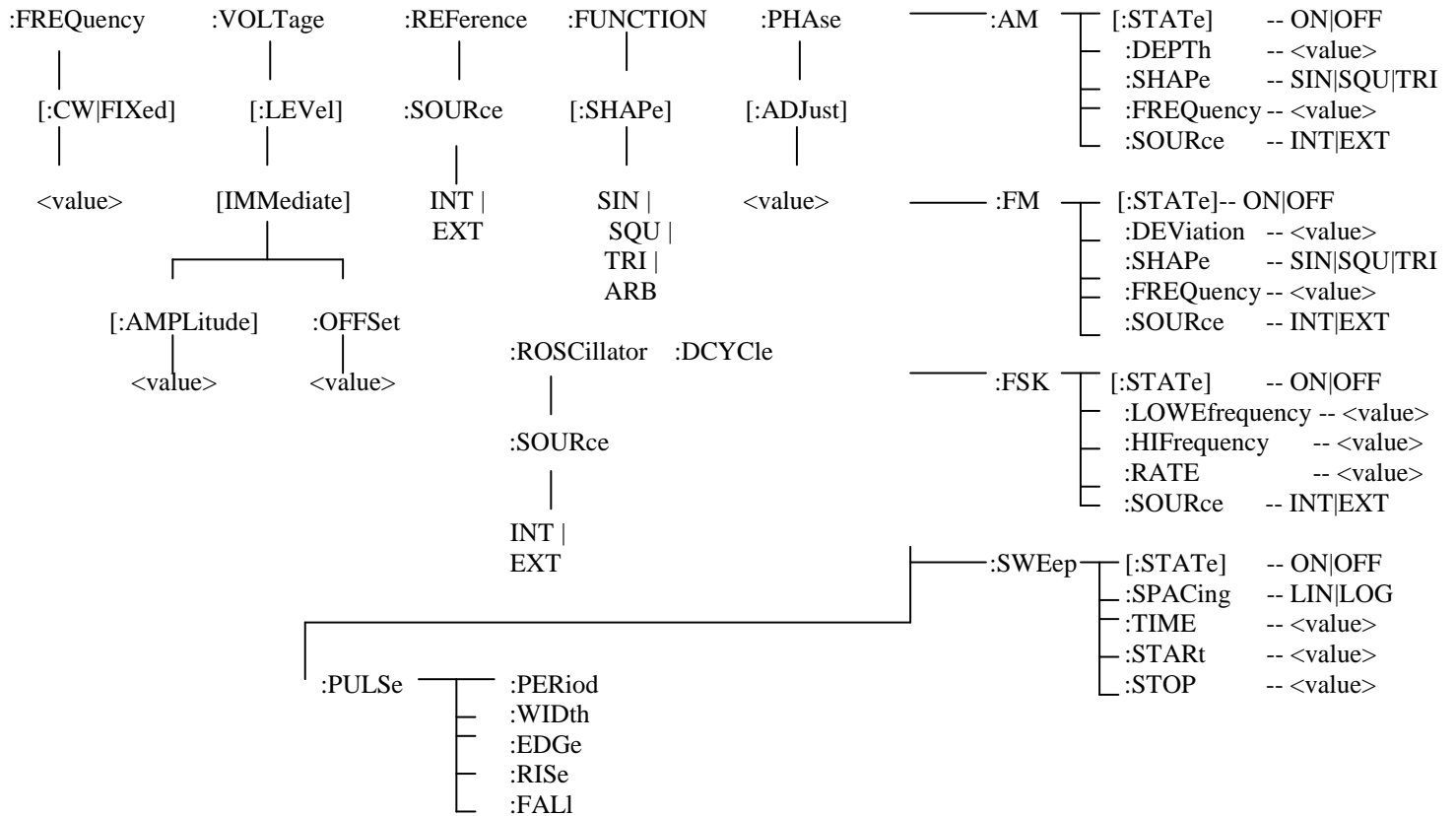

4.15.3 :OUTPut Subsystem

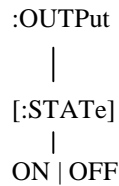

4.15.4 :TRIGger Subsystem

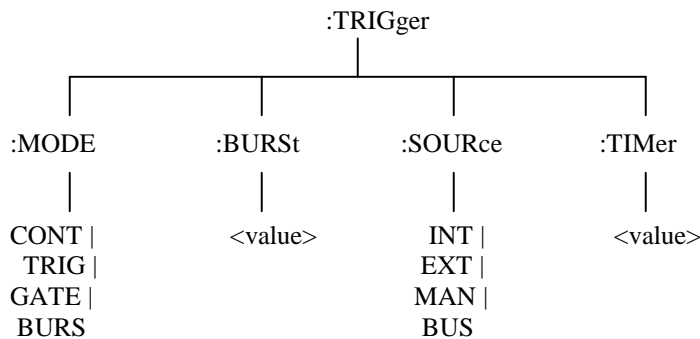

4.15.5 :ARBitrary Subsystem

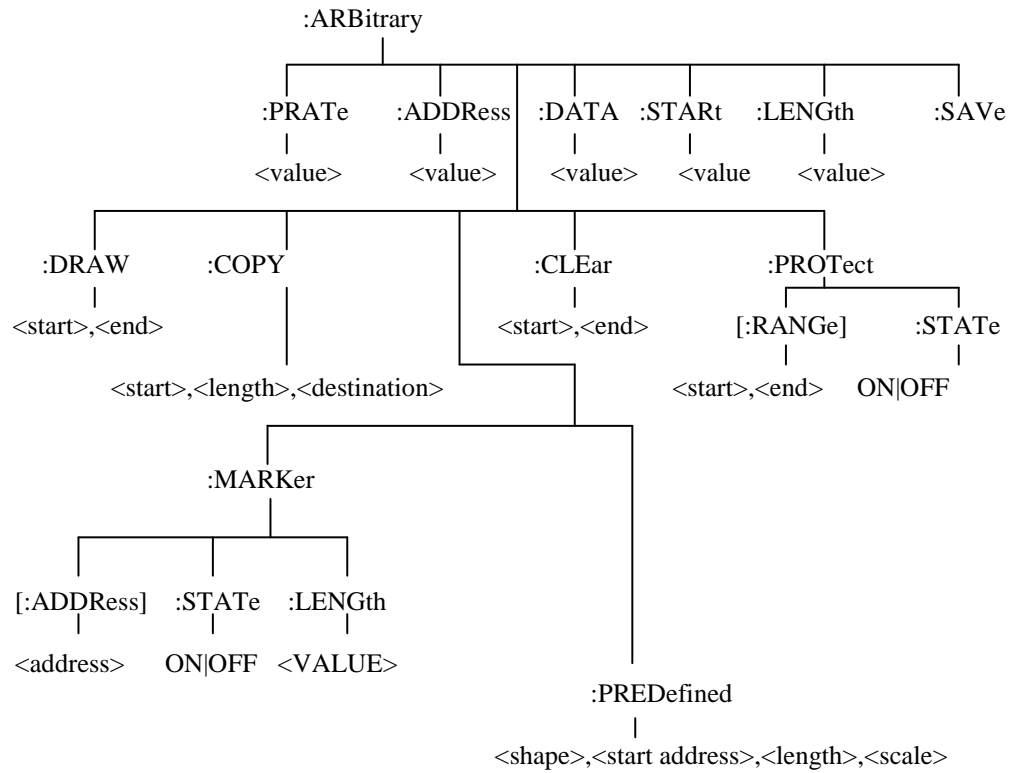

4.15.6 :STATus Subsystem

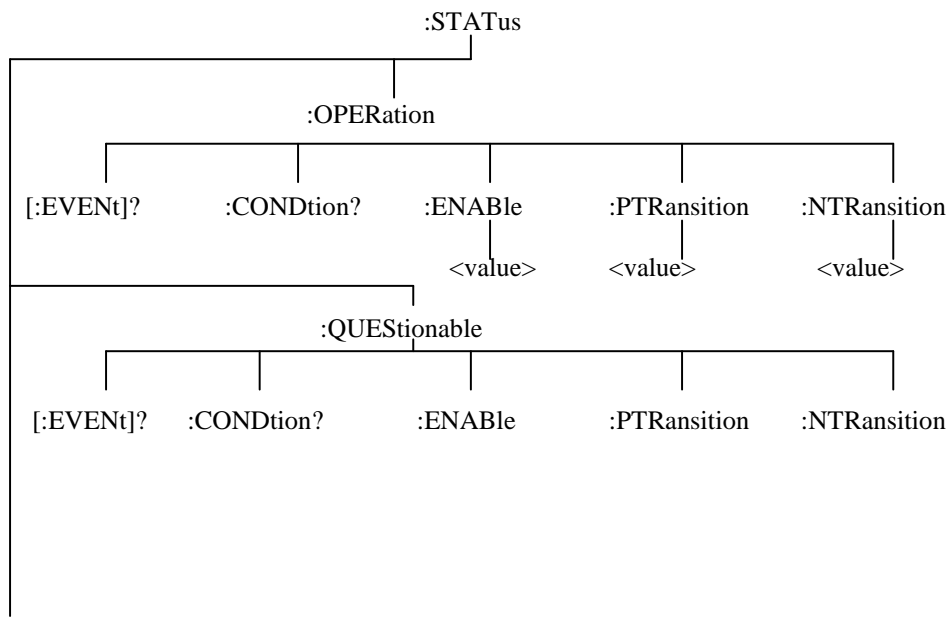

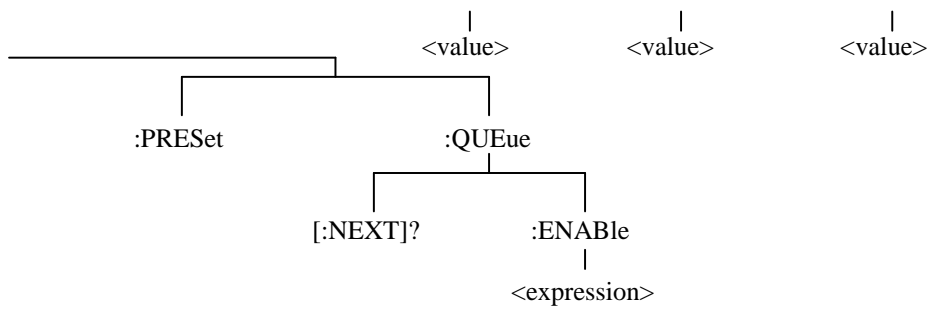

4.15.7 :SYSTem Subsystem

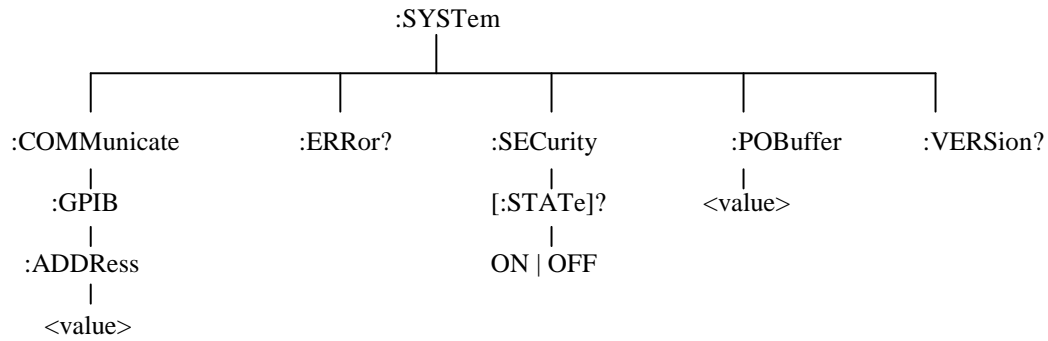

ASCII and GPIB Code Chart

Hex	Oct	Dec	ASCII	Msg	Hex	Oct	Dec	ASCII	Msg
00	000	0	NUL		20	040	32	SP	MLA0
01	001	1	SOH	GTL	21	041	33	!	MLA1
02	002	2	STX		22	042	34	"	MLA2
03	003	3	ETX		23	043	35	#	MLA3
04	004	4	EOT	SDC	24	044	36	\$	MLA4
05	005	5	ENQ	PPC	25	045	37	%	MLA5
06	006	6	ACK		26	046	38	&	MLA6
07	007	7	BEL		27	047	39	'	MLA7
08	010	8	BS	GET	28	050	40	(MLA8
09	011	9	HT	TCT	29	051	41)	MLA9
0A	012	10	LF		2A	052	42	*	MLA10

0B	013	11	VT		2B	053	43	+	MLA11
0C	014	12	FF		2C	054	44	,	MLA12
0D	015	13	CR		2D	055	45	-	MLA13
0E	016	14	SO		2E	056	46	.	MLA14
0F	017	15	SI		2F	057	47	/	MLA15
10	020	16	DLE		30	060	48	0	MLA16
11	021	17	DC1	LLO	31	061	49	1	MLA17
12	022	18	DC2		32	062	50	2	MLA18
13	023	19	DC3		33	063	51	3	MLA19
14	024	20	DC4	DCL	34	064	52	4	MLA20
15	025	21	NAK	PPU	35	065	53	5	MLA21
16	026	22	SYN		36	066	54	6	MLA22
17	027	23	ETB		37	067	55	7	MLA23
18	030	24	CAN	SPE	38	070	56	8	MLA24
19	031	25	EM	SPD	39	071	57	9	MLA25
1A	032	26	SUB		3A	072	58	:	MLA26
1B	033	27	ESC		3B	073	59	;	MLA27
1C	034	28	FS		3C	074	60	<	MLA28
1D	035	29	GS		3D	075	61	=	MLA29
1E	036	30	RS		3E	076	62	>	MLA30
1F	037	31	US		3F	077	63	?	UNL

Message Definitions

DCL	Device Clear	MSA	My Secondary Address
GET	Group Execute Trigger	MTA	My Talk Address
GTL	Go To Local	PPC	Parallel Poll Configure
LLO	Local Lockout	PPD	Parallel Poll Disable
MLA	My Listen Address		

Hex	Oct	Dec	ASCII	Msg	Hex	Oct	Dec	ASCII	Msg
40	100	64	@	MTA0	60	140	96	`	MSA0,PPE
41	101	65	A	MTA1	61	141	97	a	MSA1,PPE
42	102	66	B	MTA2	62	142	98	b	MSA2,PPE
43	103	67	C	MTA3	63	143	99	c	MSA3,PPE
44	104	68	D	MTA4	64	144	100	d	MSA4,PPE
45	105	69	E	MTA5	65	145	101	e	MSA5,PPE
46	106	70	F	MTA6	66	146	102	f	MSA6,PPE
47	107	71	G	MTA7	67	147	103	g	MSA7,PPE
48	110	72	H	MTA8	68	150	104	h	MSA8,PPE
49	111	73	I	MTA9	69	151	105	i	MSA9,PPE
4A	112	74	J	MTA10	6A	152	106	j	MSA10,PPE
4B	113	75	K	MTA11	6B	153	107	k	MSA11,PPE
4C	114	76	L	MTA12	6C	154	108	l	MSA12,PPE
4D	115	77	M	MTA13	6D	155	109	m	MSA13,PPE

4E	116	78	N	MTA14	6E	156	110	n	MSA14,PPE
4F	117	79	O	MTA15	6F	157	111	o	MSA15,PPE
50	120	80	P	MTA16	70	160	112	p	MSA16,PPD
51	121	81	Q	MTA17	71	161	113	q	MSA17,PPD
52	122	82	R	MTA18	72	162	114	r	MSA18,PPD
53	123	83	S	MTA19	73	163	115	s	MSA19,PPD
54	124	84	T	MTA20	74	164	116	t	MSA20,PPD
55	125	85	U	MTA21	75	165	117	u	MSA21,PPD
56	126	86	V	MTA22	76	166	118	v	MSA22,PPD
57	127	87	W	MTA23	77	167	119	w	MSA23,PPD
58	130	88	X	MTA24	78	170	120	x	MSA24,PPD
59	131	89	Y	MTA25	79	171	121	y	MSA25,PPD
5A	132	90	Z	MTA26	7A	172	122	z	MSA26,PPD
5B	133	91		MTA27	7B	173	123	{	MSA27,PPD
5C	134	92	\	MTA28	7C	174	124		MSA28,PPD
5D	135	93		MTA29	7D	175	125	}	MSA29,PPD
5E	136	94	^	MTA30	7E	176	126	~	MSA30,PPD
5F	137	95	_	UNT	7F	177	127	DEL	

Message Definitions

PPE	Parallel Poll Enable	SPE	Serial Poll Enable
PPU	Parallel Poll Unconfigure	TCT	Take Control
SDC	Selected Device Clear	UNL	Unlisten
SPD	Serial Poll Disable	UNT	Untalk

4.16 Block Transfer (GPIB only)

Arbitrary waveform data sent in IEEE488.2 arbitrary block format may take two forms: the definite form and the indefinite form. The essential difference between these forms is that the definite form contains a byte count, while the indefinite form does not. In both cases, the format of the command is

```
:ARB:DATA<ws><preamble><data><terminator>.
```

The <data> represents the arbitrary waveform data. This field consists of 8 bit bytes sent in hexadecimal form. Each arbitrary data point consists of two bytes with the high byte being sent first. When sending data in this way, the value of a data point may range from -8191, corresponding to the negative peak, to 8191, corresponding to the positive peak. The value 0 corresponds to zero baseline. Compare the ASCII, or front panel representation, which defines data in the range - 8191to + 8191.

Example: to set a data value to zero, send the Hex bytes

```
0000
```

The definite form <preamble> consists of two fields. The first is a single byte representing the number of digits in the byte count. The byte count is the second field in the preamble, and consists of decimal bytes (0-9), which, when taken together, give the byte count.

Example of definite form (sending values 0,1,2 decimal):

```
:ARB:DATA #16\x0\x0\x0\x1\x0\x2
```

means that the byte count consists of 1 byte only, and the number of bytes is 6. (Note: '\x' refers to Hexadecimal) .

The indefinite form preamble consists of a 0 character alone.

Example of indefinite form (same data as above):

```
:ARB:DATA #0\x0\x0\x0\x1\x0\x2\x0A
```

Since it does not contain a byte count, the indefinite form command must be terminated with EOI if using GPIB or CR and/or LF when using RS232 interface. (Note: '\x0A' is the hexadecimal value for LF)

Since each arbitrary data point consists of two bytes, an even number of bytes must be sent. In the following examples, the data is specified in Hex format with each byte being preceded by '\x', in order to show this.

Example of definite form:

```
:ARB:DATA #16\x8\x0\x8\x1\x8\x2
```

Here, the byte count consists of one byte only, and the value is 6.

Example to definite form:

```
:ARB:DATA #0\x8\x0\x8\x1\x8\x2\x0A
```

The '\x0A' represents the Linefeed character. EOI must be sent with this character.

Arbitrary data read from the instrument in binary form, as opposed to ASCII, are returned in indefinite form.

Before sending your data enable all errors to be reported, using

```
:STAT:QUEUE:ENABLE ALL.
```

Then, if the arb data command causes an error, the error message may be read from the queue using the query.

```
:SYST:ERR?
```

4.17 GPIB Communication Protocol (for models 4075GPIB & 4078GPIB)

4.17.1 General

This appendix describes the effects of interface messages on waveform generator operation and uses abbreviations from the IEEE Standard 488.1-1987.

4.17.2 Responses to IEEE-488.1 Interface Messages

Interface messages and the effects of those messages on the instrument interface functions are defined in IEEE Standard 488.1-1987. Where appropriate, the GPIB code is listed, in decimal.

UNL-Unlisten (63 with ATN)

UNT-Untalk (95 with ATN)

The UNL command places the listener function to its idle (unaddressed) state. In this idle state, the waveform generator cannot accept commands from the GPIB.

The UNT command places the talker function to its idle state. In this idle state, the waveform generator cannot output data through the GPIB.

When the talker and listener functions are idle, the front-panel ADRS indicator is off. If the waveform generator is talk-addressed or listen-addressed, the ADRS indicator lights.

IFC-Interface Clear (Bus pin 9)

The IFC message places both the listener and talk functions to idle states. When the talker and listener functions are idle, the front-panel ADRS indicator is off.

The IFC pulse is $\geq 100\mu\text{s}$.

DCL-Device Clear (20 with ATN)

The Device Clear message resets GPIB communication. That is, the DCL message clears all input and output messages, as well as all unexecuted settings.

SDC-Selected Device Clear (4 with ATN)

The SDC message causes the same response as the DCL message. However, the waveform generator only responds if it is listen-addressed.

GET-Group Execute Trigger (8 with ATN)

The waveform generator responds to the Group Execute Trigger message only if it is listening addressed and the device trigger function is enabled. The TRIGger:MODE must be in TRIG, CONTinuous, or BURst and the TRIGger:SOURce must be set to BUS to enable device triggering via GET.

SPE-Serial Poll Enable (24 with ATN)

The SPE message generates output serial poll status bytes when talk-addressed.

SPD-Serial Poll Disable (25 with ATN)

The SPD message switches back to generating output data from the Output Buffer.

MLA-My Listen Address (GPIB Address + 32)

MTA-My Talk Address (GPIB Address + 64)

The instrument GPIB primary address establishes the listen and talk addresses. To see the current GPIB primary address, press SPECIAL and then F1:SYS on the front panel. When the waveform generator is talk-addressed or listen-addressed, the front-panel ADRS indicator lights.

LLO-Local Lockout (17 with ATN)

When the waveform generator is listening addressed, the LLO message changes the waveform generator to the front-panel lockout state.

REN-Remote Enable (GPIB pin 17)

REN is normally held true by the controller and allows the controller to then put the waveform generator into one of the remote states. Pulsing REN false or holding it false forces the device into local state (LOCS).

NOTE

If you disconnect and reconnect the GPIB cable when the controller is holding REN true, the REN goes false and the device goes to local state (LOCS).

GTL-Go To Local (1 with ATN)

Listen-addressed instruments respond to GTL by changing to a local state. Remote-to-local transitions caused by GTL do not affect the execution of the message being processed when GTL was received.

Remote-Local Operation

Most front-panel controls cause a transition from REMS to LOCS by asserting a message called return-to-local (rtl). This transition can occur during message execution. However, in contrast to TGL and REN transitions, a transition initiated by rtl affects message execution. In this case, the waveform generator generates an error if there are any unexecuted setting or operational commands.

Front-panel controls that change only the display, do not affect the remote-local states. Only front-panel controls that change settings assert rtl. The rtl message remains asserted when you enter multiple keystroke settings from the front panel, and is unasserted after you execute the settings changes. Since rtl prevents transition to REMS, the waveform generator unasserts rtl if you do not complete a multiple key sequence in a reasonable length of time (about 5 to 10 seconds).

A record of the front-panel settings is in the Current Settings Buffer; however, new settings entered from the front panel or the controller update these recorded settings. In addition, the front panel updates to reflect setting changes from controller commands. Settings are unaffected by transitions among the 4 remote-local states. The REMOTE indicator lights when the waveform generator is in REMS or RWLS.
Local State (LOCS)

When in a local state (LOCS), you control the settings through the front-panel controls. In addition, only GPIB query commands are executed. All other GPIB commands, setting and operational prompt and error since those commands are under front-panel (local) control.

NOTE

The waveform generator can be in either Local State (LOCS) or Remote State (REMS) when it receives the Local Lockout (LLO) interface message. If in LOCS and REN is asserted, the waveform generator enters the Local With Lockout State (LWLS) or, if in REMS, it enters the Remote With Lockout State (RWLS) when it receives LLO. The controller controls the LWLS and RWLS state transitions.

Local Without Lockout State (LWLS)

When the waveform generator is in a local without lockout state (LWLS), it operates the same as it does in LOCS. However, in LWLS rtl does not inhibit a transition to remote state.

Remote State (REMS)

When the waveform generator is in a remote state (REMS), you control its operations from the controller. All settings update when GPIB are executed.

Remote With Lockout State (RWLS)

When in a remote with lockout state (RWLS), the waveform generator operates much the same as it does in LOCS. However, when in RWLS the waveform generator ignores the rtl message, locking out any changes made from the front panel.

4.17.3 IEEE 488.2 Interface Function Subsets

IEEE Standard 488.2 identifies the interface function repertoire of a device on the bus in terms of interface function subsets. These subsets are defined in the standard. Table C-1 lists the subsets that apply to the waveform generator.

NOTE

For more information, refer to IEEE Standard 488.2. The standard is published by the Institute of Electrical and Electronics Engineers, Inc., 345 East 47 Street, New York, New York 10017.

Table C-1: Interface Function Subsets

FUNCTION	SUBSET	CAPABILITY
Source Handshake	SH1	Complete capability
Acceptor Handshake	AH1	Complete capability
Basic Talker	T6	Responds to Serial Poll, Untalk if My Listen Address (MLA) is received
Basic Listener	L4	Unlisten if My Talk Address (MTA) is received
Service Request	SR1	Complete capability
Remote-Local	RL1	Complete capability, including Local Lockout (LLO)
Parallel Poll	PP0	Does not respond to Parallel Poll
Device Clear	DC1	Complete capability
Device Trigger	DT1	Complete capability
Controller	C0	No controller functions
Electrical Interface	E2	Three-state drive capability

Section 5

Performance Check Procedures

5.1 Introduction

This section provides the procedure for checking the electrical performance requirements of the Model 4075 and 4078 Arbitrary Waveform Generators, as listed in instrument Operating Manual Section 1: "Specifications".

If the waveform generator fails to meet these checks, then you should perform the adjustment procedure. Adjustment procedures are available on a separate document.

The Performance Check Procedures are identical for both channels on the Model 4078 and must be performed separately for each channel.

At the end of this document, a table is provided to record the test results.

5.2 Test Equipment

The following table lists the equipment necessary to perform the performance tests. Any equivalent equipment may be substituted for the recommended model.

Description	Minimum Requirements	Recommended Model
Oscilloscope	Bandwidth > 400MHz	Tektronix DPO4054
Distortion Analyzer	Frequency range 10Hz-100KHz	Tektronix AA5001
Digital Voltmeter	6 1/2 digits, true RMS	Fluke 8845A
Universal Counter	200MHz, Time A B, Period	Pendulum CNT-90
Function Generator	10MHz output	BK Model 4045
50Ω Feed-through	±1% to 1GHz (high frequency)	Tektronix 011-0049-02
Precision 50Ω Feed-through	±0.1% (DC to 100KHz)	Tektronix 012-0482-XX
50Ω Coaxial Cables, with BNC connectors, 1 m,		

5.3 Performance Tests

The following tests verify that the waveform generator operates and meets specifications. Perform the tests after a warm-up period of 30 minutes at an ambient temperature of $22^{\circ}\text{C} \pm 3^{\circ}\text{C}$.

You can use these tests for periodic inspection and for inspection after repair.

NOTE *In the following procedures, all test conditions for the waveform generator are power-up conditions with output ON, unless otherwise specified.*

5.3.1 Frequency Accuracy

Specification: 0.002% (20ppm) for the DDS waveforms. 0.005% for the Arbitrary waveforms.

Procedure:

1. Connect the OUTPUT connector to the counter input using a 50 ohm coaxial cable and a 50 ohm feedthrough termination.
2. Select SQUARE to generate a square waveform with 1MHz frequency and 5Vp-p.
3. Set the counter to measure frequency with maximum digits resolution.
4. **CHECK** for a frequency reading between 999980 Hz and 1000020 Hz.
5. Select ARB waveform. Press F1 - RATE and enter 1 us.
4. Connect the unit REF OUT connector (on the rear panel of the unit) to the counter, using the coax cable and 50 ohms termination.
5. **CHECK** for a frequency reading between 999950 Hz and 1000050 Hz.

5.3.2 Amplitude Accuracy

Specification: $\pm 1.0\% \pm 10\text{mV}$ of programmed value, into a 50 ohms termination, for a waveform frequency of 1KHz.

Procedure:

1. Connect the OUTPUT connector to the input of the TRUE RMS DVM using a 50 ohm coaxial cable and the 50 ohm 0.1% termination.
4. Set the DVM to measure ac volts.
5. Set the unit to generate a SINE wave signal with 1 KHz frequency and an amplitude of 10Vp-p
6. **CHECK** that the measured voltages on the DVM at 10Vp-p, 5Vp-p, 3Vp-p, 1Vp-p, 100 mVp-p and 50mVp-p are in the accuracy range:

Amplitude setting	Minimum reading RMS	Maximum reading RMS	DVM reading RMS
10Vp-p	3.499V	3.572V	
5Vp-p	1.749V	1.786V	
3Vp-p	1.049V	1.072V	
1Vp-p	0.349V	0.358V	
100mVp-p	34 mV	37 mV	
50mVp-p	17 mV	19 mV	

5. Set the unit to generate a SQUARE wave with 1KHz frequency.

6. **CHECK** that the measured voltages on the DVM at 10Vp-p, 5Vp-p, 3Vp-p, 1Vp-p, 100 mVp-p and 50mVp-p are in the accuracy range:

Amplitude setting	Minimum reading RMS	Maximum reading RMS	DVM reading RMS
10Vp-p	4.949V	5.051V	
5Vp-p	2.474V	2.526V	
3Vp-p	1.484V	1.516V	
1Vp-p	0.494V	0.51	
100mVp-p	49 mV	52 mV	
50mVp-p	24 mV	26 mV	

4 Set the unit to the ARBITRARY function and generate a sine wave signal:

- Press the ARB key
- Select F2 – ARB
- Select F4 – EDIT
- Select F3 – PREDEF
- Select F2 – FROM, press key 1 and ENTER
- Select F2 – DATA, press key 0 and ENTER
- Select F3 – LENG, press 1000 and ENTER
- Select F3 – SCALE, press 100 and ENTER
- Select F4 – EXEC
- Select F3 – YES
- Select ARB
- Select F1 – FREQ, press 1000 Hz

- Select OUT ON

8. **CHECK** that the measured voltages on the DVM at 10Vp-p, 5Vp-p, 3Vp-p, 1Vp-p, 100 mVp-p and 50mVp-p are in the accuracy range:

Amplitude setting	Minimum reading RMS	Maximum reading RMS	DVM reading RMS
10Vp-p	3.499V	3.572V	
5Vp-p	1.749V	1.786V	
3Vp-p	1.049V	1.072V	
1Vp-p	0.349V	0.358V	
100mVp-p	34 mV	37 mV	
50mVp-p	17 mV	19 mV	

5.3.3 Offset Accuracy

Specification: $\pm 1\%$ of programmed value $\pm 10\text{mV}$, into 50 ohm

Procedure:

1. Connect the OUTPUT connector to the input of the DVM using a 50 ohm coaxial cable and the 50 ohm 0.1% termination.
2. Set the DVM to measure DC volts.
3. Set the unit to generate a SINE wave signal with 1 KHz frequency. Set the unit amplitude to 10mVp-p
4. Set the unit offset to +4V.
- 7 **CHECK** that the measured voltages on the DVM at offsets of +4Vp-p, +2Vp-p, 0Vp-p, -2Vp-p, -4Vp-p are in the accuracy range:

Offset setting	Minimum reading	Maximum reading	DVM reading
+4V	3.950V	4.050V	
+2V	1.970V	2.030V	
0V	-10mV	+10mV	
-2V	-1.970V	-2.030V	
-4V	-3.950V	-4.050V	

5.3.4 Sine Distortion

Specification: - 65 dB to 20 KHz.

Procedure:

-
- 7.13 Connect the OUTPUT connector to the distortion analyzer using a 50 ohm coaxial cable and a 50 ohm feedthrough termination.
 - 7.14 Set the unit to generate a sine waveform with 1KHz frequency and 10Vp-p.
 - 7.15 Set the distortion analyzer to measure distortion in dB and select RMS response.
 - 7.16 **CHECK** for a reading of more than -65 dB.

5.3.5 Square Transition Times

Specification: < 6 ns (10% to 90%) at 10Vp-p into 50 ohms.

Procedure:

1. Connect the OUTPUT connector to the oscilloscope input using a 50 ohm coaxial cable and a 50 ohm feedthrough termination.
2. Select WAVE and SQUARE to generate square waveform with 1MHz frequency and 10Vp-p.
3. Use the oscilloscope markers to measure the Rise and Fall times of the square, from 10% to 90% levels.
4. **CHECK** for rise and fall times of < 12 ns.

5.3.6 Square Variable Duty Cycle

Specification: variable from 20% to 80% with $\pm 0.5\%$ accuracy at 1 KHz.

Procedure:

1. Connect the OUTPUT connector to the counter input using a 50 ohm coaxial cable and a 50 ohm feedthrough termination.
2. Select SQUARE to generate square waveform with 1KHz frequency and 5Vp-p.
3. Set the counter to measure duty cycle and select the automatic trigger mode.
4. On the unit change the symmetry to 20%, 50% and 80%
5. **CHECK** for duty cycle readings between 19.0% - 21.0%, 49.0% - 51.0% and 79.0% - 81.0%.

5.3.7 Operating Modes

Specification: Continuous, triggered, gated, and burst.

Procedure:

1. Connect the OUTPUT connector to the oscilloscope vertical input using a 50 ohm coaxial cable and a 50 ohm feed-through termination.
2. Push the MODE key on the unit front panel.
3. Verify that the oscilloscope displays a 1KHz sine wave. Make sure that the Output is ON.

-
4. Set the external function generator for a square wave output from 0V to 2V at 200 Hz.
 5. Connect the function generator output to the unit TRIG IN connector.
 6. Set the waveform generator:

Step 1. Set the output mode to triggered	MODE F2 - TRIG
Step 2. Set the trigger source to internal	F2 - INT
 7. **CHECK**-Verify that the oscilloscope displays one cycle of sine wave per trigger event.
 8. Set the waveform generator:

Set the output mode to external trigger	MODE F2-TRIG F3 - EXT
---	-----------------------------
 9. **CHECK**-Verify that the oscilloscope displays one sine waves per external trigger
 10. Set the waveform generator:

Set the output mode to burst.	MODE F2 - BRST F2 - INT
-------------------------------	-------------------------------
 11. **CHECK**-Verify that the oscilloscope displays two cycles of sine wave per trigger event.
 12. If you have a Model 4078 unit, connect the CH2 OUTPUT connector to the oscilloscope, push CHAN key and repeat steps 2 through 13 for channel 2 (using CH2 control settings and CH2 TRIG IN connector).

5.3.8 Sync Output - Marker Output - Reference Output

Specification: TTL-level pulses at programmed frequency.

Procedure:

- 2) Connect the SYNC OUT connector to the oscilloscope vertical input.
- 3) Set the unit to generate sine waves at 1 KHz and **CHECK** for a square waveform with levels of 0V and >4V. on the oscilloscope.
- 4) Connect the REF OUT connector to the oscilloscope vertical input.
- 5) **CHECK** for a 10 MHz square wave with 0V and >4V levels on the oscilloscope.
- 6) Connect the MARKER OUT connector to the oscilloscope vertical input.
- 7) Program the unit to generate an Arbitrary waveform with Marker:

- Press the ARB key

-
- Select F2 – ARB
 - Select F4 – EDIT
 - Select F3 – PREDEF
 - Select F2 – FROM, press key 1 and ENTER
 - Select F2 – DATA, press key 0 and ENTER
 - Select F4 – EXEC
 - Select F3 – YES
 - Select ARB
 - Select F2 – ARB
 - Select F3 – MARK
 - Select F3 – ON

7. **CHECK** for a pulse with a 1us width and with 0V and >4V levels on the oscilloscope.

5.3.8 External Modulation

Specification: 5 Vp-p for 100% AM modulation.

Procedure:

- 4 Connect the OUTPUT connector to the oscilloscope input using a 50 ohm coaxial cable and a 50 ohm feedthrough termination.
- 5 Set the unit to generate a SINE waveform with 1 KHz frequency and 5 Vp-p output.
- 6 Connect the external function generator to the MODULATION IN of the unit.
Use a coax cable with 50 ohm feedthrough termination.
4. Set the external function generator for a sine wave output with 400 Hz frequency and 3Vp-p output.
5. On the unit select MODUL and then F1- AM, again F1- ON and then F4 - EXT
- 4 **CHECK** on the oscilloscope for an amplitude modulated waveform that is changing the modulation depth by changing the external generator output amplitude.

5.3.10 RS232 Capability

1. Connect the waveform generator to a computer with RS232 capabilities.
4. Select RS232 remote operation mode on the UTIL menu and 19200 baud rate.

For more information on RS232 programming, see the Operation Manual, Section 4: Programming.

Performance Tests Results

Setting	Minimum reading	Maximum reading	Reading
Frequency DDS			
1 MHz	999980 Hz	1000020 Hz	
Frequency ARB			
1 MHz	999950 Hz	1000050 Hz	
Sine Amplitude			
10Vp-p	3.499V	3.572V	
5Vp-p	1.749V	1.786V	
3Vp-p	1.049V	1.072V	
1Vp-p	0.349V	0.358V	
100mVp-p	34 mV	37 mV	
50mVp-p	17 mV	19 mV	
Square Amplitude			
10Vp-p	4.949V	5.051V	
5Vp-p	2.474V	2.526V	
3Vp-p	1.484V	1.516V	
1Vp-p	0.494V	0.51	
100mVp-p	49 mV	52 mV	
50mVp-p	24 mV	26 mV	
ARB Amplitude			
10Vp-p	3.499V	3.572V	
5Vp-p	1.749V	1.786V	
3Vp-p	1.049V	1.072V	
1Vp-p	0.349V	0.358V	
100mVp-p	34 mV	37 mV	
50mVp-p	17 mV	19 mV	
Offset Accuracy			
+4V	3.950V	4.050V	
+2V	1.970V	2.030V	
0V	-10mV	+10mV	
-2V	-1.970V	-2.030V	
-4V	-3.950V	-4.050V	
Sine Distortion			
1 KHz	- 65 dB		
Square Transition			
1 MHz	12 ns		
Variable Duty Cycle			
20%	19.00%	21.00%	
50%	49.00%	51.00%	

80%	79.00%	80.00%	
-----	--------	--------	--

	Yes	No
Operating Modes: Triggered		
Burst		
External Trigger		
Sync Output		
Marker Output		
Reference Output		
External Modulation		
RS-232		

BK PRECISION®

22820 Savi Ranch Parkway
Yorba Linda, CA 92887
www.bkprecision.com

© 2010 B&K Precision Corporation