

Datasheet - AZ 16-03ZVRK

Safety switch with separate actuator / AZ 16

Image: [LOGO]



- thermoplastic enclosure
- Double-insulated
- Large wiring compartment
- 52 mm x 90 mm x 30 mm
- Multiple coding
- Long life
- High level of contact reliability with low voltages and currents
- Slotted holes for adjustment, circular holes for location
- 3 cable entries M 16 x 1.5

(Minor differences between the printed image and the original product may exist!)

Ordering details

Product type description	AZ 16-03ZVRK
Article number	1154220
EAN code	4030661171579

Approval

Approval

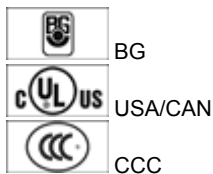

Classification

Standards	EN ISO 13849-1
B _{10d} Opener (NC)	2.000.000
Mission time notice	20 Years
	$MTTF_d = \frac{B_{10d}}{0,1 \times n_{op}}$ $n_{op} = \frac{d_{op} \times h_{op} \times 3600 \text{ s/h}}{t_{zyklus}}$

Global Properties

Product name	AZ 16
Standards	EN 60947-5-1, BG-GS-ET-15
Compliance with the Directives (Y/N) 	Yes

Materials	
- Material of the housings	Plastic, glass-fibre reinforced thermoplastic, self-extinguishing
- Material of the contacts	Silver
Housing coating	None
Weight	115 g

Mechanical data

Design of electrical connection	Screw connection
Cable section	
- Min. Cable section	0,75 mm ²
- Max. Cable section	2.5 mm ²
Mechanical life	20.000.000 operations
higher Latching force (Y/N)	Yes
Latching force	30 N
With ejection force (Y/N)	No
Positive break force	30 N
positive break travel	8 mm
Max. Actuating speed	0,2 m/s
notice	All indications about the cable section are including the conductor ferrules.

Ambient conditions

Ambient temperature	
- Min. environmental temperature	-30 °C
- Max. environmental temperature	+80 °C
Protection class	IP67 to IEC/EN 60529

Electrical data

Design of control element	Opener (NC)
Switching principle	Creep circuit element
Number of auxiliary contacts	0 piece
Number of safety contacts	3 piece
Rated impulse withstand voltage U _{imp}	6 kV
Rated insulation voltage U _i	500 V
Thermal test current I _{the}	10 A
Utilisation category	AC-15: 230 V / 4 A, DC-13: 24 V / 4 A
Max. fuse rating	6 A gG D-fuse

ATEX

Explosion protection categories for gases	None
Explosion protected category for dusts	None

Dimensions

Dimensions of the sensor	
- Width of sensor	52 mm
- Height of sensor	90 mm
- Length of sensor	30 mm



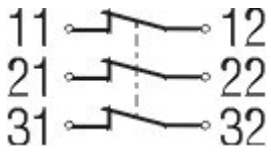

Included in delivery

Actuators must be ordered separately.

Diagram





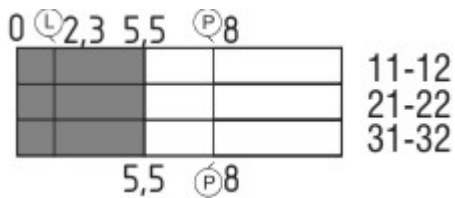

Note Diagram

-  positive break NC contact
-  active
-  no active
-  Normally-open contact
-  Normally-closed contact

Switch travel diagram



Notes Switch travel diagram

-  Contact closed
-  Contact open
-  Setting range
-  Break point
-  Positive opening sequence/- angle
- VS** adjustable range of NO contact
- VÖ** adjustable range of NC contact
- N** after travel

Ordering suffix

The applicable ordering suffix is added at the end of the part number of the safety switch.

Order example: AZ 16-03ZVRK-**2254**

...-**2254**

Latching force 5 N

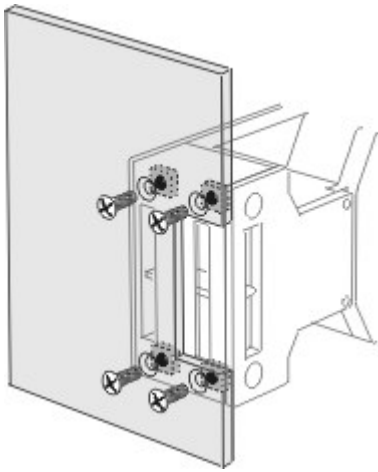

...- 1762

Cannot be retrofitted

...-1637

0,3 µm gold-plated contacts

...- M20

cable entries M20

Ordering code

AZ 16-(1)ZV(2)K-(3)-(4)-(5)

(1)

without 1 Normally open contact (NO) / 1 Opener (NC)

02 2 Opener (NC)

03 3 Opener (NC)

12 Normally open contact (NO) 1 / Opener (NC) 2

(2)

without Ejection force

R Latching force 30 N

(3)

G24 with LED (*only available for version with one NO and one NC contact.*)

(4)

without Cable entry M16

M20 Cable entry M20

ST Connector M12, 4-pole, bottom

STL Connector M12, 4-pole, left

STR Connector M12, 4-pole, right

(5)

2254 Latching force 5 N

1762 Front mounting

1637 gold-plated contacts

Documents

Operating instructions and Declaration of conformity (de) 396 kB, 18.02.2011

http://127.0.0.1/Bilddata/AZ/Pdf/Az15_16/bedien/DE/mrl_az15-16_de.pdf

Operating instructions and Declaration of conformity (en) 516 kB, 26.05.2010

http://127.0.0.1/Bilddata/AZ/Pdf/Az15_16/bedien/EN/mrl_az15-16_en.pdf

Operating instructions and Declaration of conformity (fr) 442 kB, 01.07.2010

http://127.0.0.1/Bilddata/AZ/Pdf/Az15_16/bedien/FR/mrl_az15-16_fr.pdf

Operating instructions and Declaration of conformity (pt) 436 kB, 24.06.2010

http://127.0.0.1/Bilddata/AZ/Pdf/Az15_16/bedien/pt/mrl_az15-16_pt.pdf

Operating instructions and Declaration of conformity (es) 405 kB, 25.03.2011

http://127.0.0.1/Bilddata/AZ/Pdf/Az15_16/bedien/ES/mrl_az15-16_es.pdf

Operating instructions and Declaration of conformity (br) 436 kB, 26.05.2010

http://127.0.0.1/Bilddata/AZ/Pdf/Az15_16/bedien/AZ_15_16_ACE/br/mrl_az15-16_br.pdf

Operating instructions and Declaration of conformity (pt) 433 kB, 25.05.2010

http://127.0.0.1/Bilddata/AZ/Pdf/Az15_16/bedien/AZ_15_16_ACE/pt/mrl_az15-16_pt.pdf

Operating instructions and Declaration of conformity (jp) 479 kB, 15.03.2011

http://127.0.0.1/Bilddata/AZ/Pdf/Az15_16/bedien/JP/mrl_az15-16_jp.pdf

Operating instructions and Declaration of conformity (it) 330 kB, 27.11.2009

http://127.0.0.1/Bilddata/AZ/Pdf/Az15_16/bedien/IT/mrl_az15-16_it.pdf

Operating instructions and Declaration of conformity (nl) 431 kB, 14.09.2010

http://127.0.0.1/Bilddata/AZ/Pdf/Az15_16/bedien/NL/mrl_az15-16_nl.pdf

BG-test certificate (en) 197 kB, 01.06.2010

http://127.0.0.1/Bilddata/AZ/Pdf/Az15_16/baumuste/z_z15p02.pdf

BG-test certificate (de) 198 kB, 01.06.2010

http://127.0.0.1/Bilddata/AZ/Pdf/Az15_16/baumuste/z_z15p01.pdf

CCC certification (cn) 730 kB, 12.12.2006

http://127.0.0.1/Bilddata/AZ/Pdf/Az15_16/zertifikat/q_175p03.pdf

Gost certification (ru) 1 MB, 21.06.2007

http://127.0.0.1/Bilddata/AZ/Pdf/Az15_16/zertifikat/q_az1p01.pdf

Images

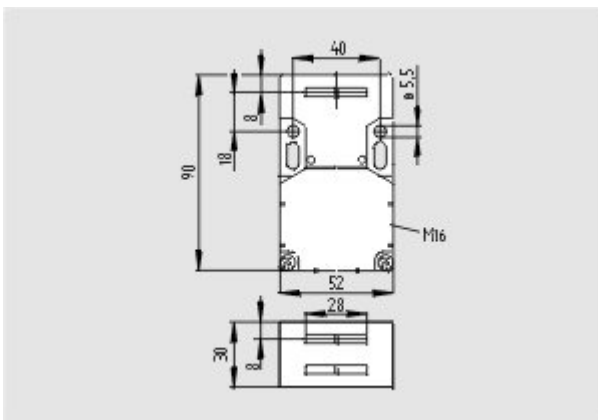

Dimensional drawing (basic component)

System components

Actuator

1083036 - AZ 15/16-B1



1092711 - AZ 15/16-B1-1747



- For play-free interlocking of light guards
- Suitable for retrofitting

1093553 - AZ 15/16-B1-1747



- For play-free interlocking of light guards
- The magnetic latch can be easily fitted in any actuating plane
- Suitable for retrofitting

1108276 - AZ 15/16-B1-2024



1108278 - AZ 15/16-B1-2024 WITH SLOT SEALING PLUG



- For protection against the ingress of course dirt

1111079 - AZ 15/16-B1-2053



- For interlocking of light to medium-weight guards

1111081 - AZ 15/16-B1-2053 WITH BALL LATCH



- For interlocking of light to medium-weight guards

1126793 - AZ 15/16-B1-2177



- For interlocking of light, unguided guards



1126794 - AZ 15/16-B1-2177 WITH CENTERING GUIDE

- For interlocking of light, unguided guards



1137408 - AZ 15/16-B1-2245

- Damps vibration on guard device



1095558 - AZ 15/16-B2

- For very small actuating radii in line with the plane of the actuator



1096091 - AZ 15/16-B2-1747

- For very small actuating radii in line with the plane of the actuator
- Suitable for retrofitting
- For play-free interlocking of light guards



1096089 - AZ 15/16-B2-1747 WITH MAGNETIC LATCH

- For very small actuating radii in line with the plane of the actuator
- Suitable for retrofitting
- For play-free interlocking of light guards
- The magnetic latch can be easily fitted in any actuating plane



1095550 - AZ 15/16-B3

- For very small actuating radii at 90° to the plane of the actuator



1096090 - AZ 15/16-B3-1747 WITH MAGNETIC LATCH

- For very small actuating radii at 90° to the plane of the actuator
- Suitable for retrofitting
- For play-free interlocking of light guards
- The magnetic latch can be easily fitted in any actuating plane

1096092 - AZ 15/16-B3-1747

- For very small actuating radii at 90° to the plane of the actuator
- Suitable for retrofitting
- For play-free interlocking of light guards



1137434 - AZ 15/16-B6

- For very small actuating radii in line with or at 90° to the plane of the actuator



Door-handle system**AZ 16-ST530**

- Latching handle
- Suitable for all types of guard

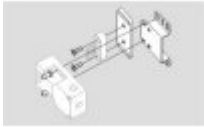
Accessories**1149214 - Mounting set MS AZ 15/16 R/P**

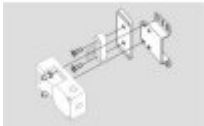
1150373 - Mounting set MS AZ 15/16 P

1089116 - Slot sealing plugs AZ 15/16-1476

- For protection against the ingress of coarse dirt
- To cover unused actuator slots
- Simple clip-in fitting



1115025 - Ball latch 2053-2

- Additional ball latch for stable latching of light to medium-weight guards
- For separate mounting on the guard



1110500 - SZ 16/335

- To prevent inadvertent closing, e.g. during maintenance
- For complex plant
- Prevents actuation of the switch



- Up to 6 padlocks can be fitted
- The lockout tag can be mounted on a chain near to the safety switch

Mounting accessories



1135338 - TAMPERPROOF SCREWS M 5 x 12

- To mount the actuator
- Higher protection against tampering with interlock
- Protects against unauthorised removal of actuator
- Various lengths available



1135339 - TAMPERPROOF SCREWS M 5 x 16

- To mount the actuator
- Higher protection against tampering with interlock
- Protects against unauthorised removal of actuator
- Various lengths available



1135340 - TAMPERPROOF SCREWS M 5 x 20

- To mount the actuator
- Higher protection against tampering with interlock
- Protects against unauthorised removal of actuator
- Various lengths available

K.A. Schmersal GmbH, Möddinghofe 30, D-42279 Wuppertal

The data and values have been checked thoroughly. Technical modifications and errors excepted.

Generiert am 26.04.2011 - 18:26:59h Kasbase 1.4.7 DBI