

# Modicon® Premium™ automation platform

Catalog  
2010



**Schneider**  
Electric

**Schneider Electric - North American Operating Division**

<http://www.schneider-electric.us/>

8001 Knightdale Blvd.  
Knightdale, NC 27545  
Tel: 919-266-3671

19 Waterman Avenue  
Toronto, Ontario M4B 1Y2  
Tel: 416-752-8020

The information provided in this documentation contains general descriptions and/or technical characteristics of the performance of the products contained herein. This documentation is not intended as a substitute for and is not to be used for determining suitability or reliability of these products for specific user applications. It is the duty of any such user or integrator to perform the appropriate and complete risk analysis, evaluation and testing of the products with respect to the relevant specific application or use thereof. Neither Schneider Electric nor any of its affiliates or subsidiaries shall be responsible or liable for misuse of the information contained herein.

**Please note:** not all parts listed in this catalog are available in all countries.

Design: Schneider Electric  
Photos: Schneider Electric









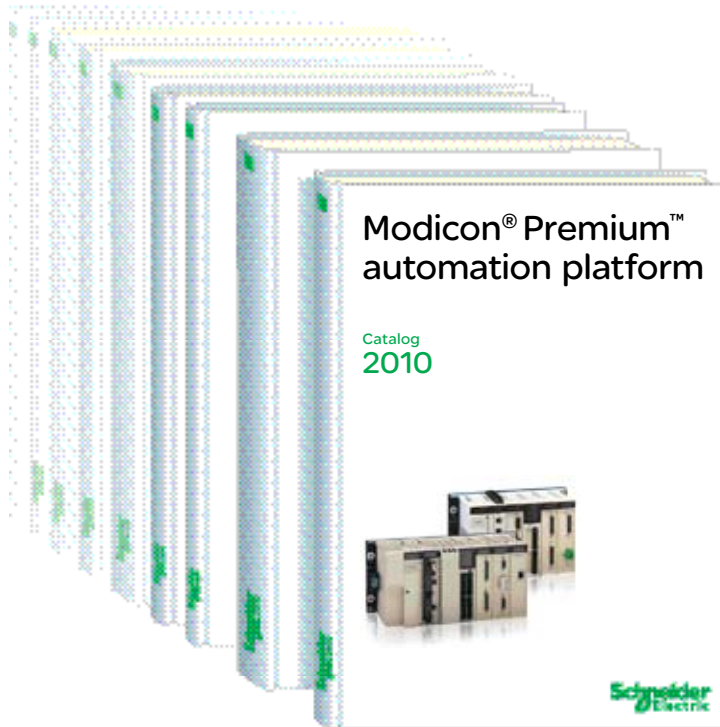



2010 Modicon<sup>®</sup> Premium<sup>™</sup> automation platform



# A full range of catalogs for . . . .



Detection	Automation	Automation	Operator dialog	Motion and Drives
 <b>Global Detection</b> <b>Electronic and electromechanical sensors</b>  MKTED208052EN  Photo-electric sensors Proximity sensors Capacitive proximity sensors Ultrasonic sensors Limit switches Pressure switches Rotary encoders Radio frequency identification Machine cabling accessories	 <b>Modicon® Momentum™</b> <b>distributed I/O and control</b>  MKTED205061EN   <b>Modicon® Quantum™</b> <b>automation platform</b> <b>Catalog 2009</b>  MKTED208011EN-US   <b>Modicon® Premium™</b> <b>automation platform</b> <b>Catalog 2010</b>  MKTED208054EN-US   <b>Modicon® M340™ and</b> <b>Unity software</b>  DIA6ED2081007EN  PLCs Discrete, analog I/O and application-specific solutions Communication	 <b>Twido® programmable</b> <b>controller and Twido Suite™</b> <b>software</b>  DIA3ED2090202EN  Controller base Discrete, analog I/O Communication   <b>Automation functions,</b> <b>relays, interfaces and</b> <b>power supplies</b>  MKTED207031EN  Smart relays Timing relays Measurement & control relays Analog interfaces Counters Plug-in relays Interfaces for discrete signals Power supplies & transformers  <b>Software</b> PLCs and safety controllers programming software	 <b>Control and signalling</b> <b>components</b>  MKTED208031EN  Control and signalling units Control stations & enclosures Cam switches Beacons and indicator banks Pendant control stations Controllers Emergency stops Foot switches   <b>Human-Machine interfaces</b>  MKTED206071EN  Operator interface terminals Industrial PCs HMI and SCADA PC-based software  <b>Software</b> Vijeo Designer Operator terminal software	 <b>Lexium® 32 Servo Drives</b> <b>motion control</b> <b>Catalog 2009/2010</b>  DIA7ED2090405EN-US  Motion controllers Servo drives and Servo motors Stepper motors and drives Integrated drives Modicon Premium motion control modules   <b>Soft starters and variable</b> <b>speed drives</b>  MKTED206111EN  Soft starters and variable speed drives  <b>Software</b> Software for drives Motor control programming software

Not all products shown in this catalog are available in every country. Check individual country's web site or Sales Office for product availability.  
 See on: [www.schneider-electric.com](http://www.schneider-electric.com)

# ....Automation & Control functions



Motor control	Machine safety	Interfaces and I/O	Power supplies	Systems & architectures
<p> <b>Motor starter solutions</b> <b>Control and protection components</b></p> <p>MKTED205103EN</p> <p>Contactors Circuit-breakers, fuse carriers Thermal relays Combinations, motor controllers Mounting solutions Motor starter mounting kits</p>	<p><i>This catalog contains Automation and Control function products relating to machines</i> <b>Safety</b></p> <p> <b>Preventa™</b> <b>Machine Safety Products Catalog 2009</b></p> <p>MKTED208051EN-US</p> <p>Safety PLCs Safety controllers Safety monitors Safety solutions on AS-Interface cabling system Safety switches Safety light curtains Safety mats Emergency stops Control stations Enabling switches Foot switches Beacons &amp; indicator banks Switch disconnectors Thermal-magnetic motor circuit breakers Enclosed D.O.L. starters</p> <p><b>Software</b> XPSMFWIN configuration software XPSMCWIN configuration software</p>	<p> <b>Terminal blocks</b></p> <p>MKTED207011EN</p> <p>Terminal blocks Cable ends</p> <p> <b>Advantys™ STB</b> <b>IP 20 distributed inputs/outputs</b></p> <p>MKTED208053EN</p> <p>Modules for automation island Network interfaces Power distribution Digital I/O, analogs and application-specific</p> <p><b>Software</b> STB configuration software</p>	<p> <b>Phaseo® power supplies and transformers</b></p> <p>DIA3ED2061209EN</p> <p>Switch mode power supplies Filtered rectified power supplies Transformers</p>	<p><i>This catalog contains Automation and Control function products relating to Communication</i></p> <p> <b>Machine &amp; Installations with industrial communication</b></p> <p>MKTED207012EN</p> <p>Preferred implementations Ethernet TCP/IP, the universal communication standard CANopen for machines and installations AS-interface, simple and safe</p> <p><b>Products</b> Human-Machine interface Controllers and PLCs Field devices Infrastructure and wiring Gateways</p> <p><b>Software and tools</b> Collaborative Automation Partner Program &amp; Partners</p>

---

<b>1 – Premium™ processors</b>	
Unity™ selection guide .....	1/2
Unity processors .....	1/4
PL7™ selection guide .....	1/16
PL7 processors .....	1/18
<b>2 – Racks, I/O architectures and power supplies</b>	
Power supply and fan modules .....	2/2
Single rack configuration .....	2/6
Multi-racks configuration without remote module .....	2/8
Multi-racks configuration with remote module .....	2/12
<b>3 – Discrete and analog I/O</b>	
Discrete I/O modules .....	3/2
Analog I/O modules .....	3/20
Distributed I/O modules .....	3/28
TeSys® Quickfit for motor starter components .....	3/42
<b>4 – Application-specific modules and solutions</b>	
Preventa™ machine safety modules .....	4/2
Counter and electronic cam modules .....	4/18
Motion control modules .....	4/32
Integrated weighing system .....	4/54
Hot Standby redundancy (Unity) .....	4/60
Warm Standby redundancy (PL7) .....	4/70
<b>5 – Communication</b>	
Selection guides .....	5/2
Ethernet network - Transparent Ready® .....	5/12
CANopen machine bus .....	5/62
AS-Interface® sensor/actuators bus .....	5/68
X-Way™ bus and network .....	5/74
Modbus Plus™ network and Profibus DP/INTERBUS® buses .....	5/90
Modbus®, Uni-Telway™ and asynchronous serial links .....	5/100

---

<b>6 – Software</b>	
Unity™ software .....	6/2
PL7™ software .....	6/60
Vijeo® Citect® supervisory software .....	6/90
OPC Factory Server (OFS)™ software .....	6/100
<b>7 – Human/Machine Interfaces</b>	
Magelis® Small Panel units and terminals .....	7/2
Magelis Advanced Panel .....	7/4
HMI software .....	7/6
<b>8 – Connection interfaces and power supplies</b>	
Advantys™ Telefast® ABE 7 pre-wired system .....	8/2
Phaseo® Universal range power supplies .....	8/20
Phaseo AS-Interface® range switch mode power supplies .....	8/34
<b>9 – Services</b>	
<b>Treatment for severe environments</b>	
Conformal Coating Premium modules .....	9/2
<b>TSX™ PSY power supply module selection document</b> .....	9/6
<b>Technical information</b>	
Standards, certifications and environment conditions .....	9/8
Ethernet network, infrastructure .....	9/12
Automation product certifications .....	9/18
<b>MFB (Motion Function Blocks) Library</b>	
Motion Control .....	9/20
<b>Index</b>	
Product reference index .....	9/22





**1.1 - Premium processors - Unity™**

**Processors and slot-PLCs Selection guide ..... 1/2**

- Premium processors
  - Presentation ..... 1/4
  - Description ..... 1/5
  - Memory structure ..... 1/8
  - Characteristics ..... 1/10
  - References ..... 1/12
- PCMCIA memory extension cards ..... 1/14

**1.2 - Premium processors - PL7™**

**Processors Selection guide ..... 1/16**

- Premium processors
  - Presentation ..... 1/18
  - Description ..... 1/19
  - Characteristics ..... 1/20
  - Memory structure ..... 1/22
  - References ..... 1/23
- PCMCIA memory extension cards ..... 1/24

# Modicon® Premium™ automation platform

## Premium processors

### Unity™ Pro software

1

Premium™ platform for Unity™ Pro software offer

TSX™ 57 0● processor

TSX 57 1● processors



<b>Number of racks</b> (according to rack type)	
<b>In-rack I/O</b> (1)	Discrete I/O
	Analog I/O
<b>In-rack application-specific channels</b>	Max. no. of channels
	Integrated counter (max. 40 kHz)
	Counter
	Motion (2)
	Weighing
<b>Serial link connections</b>	Modbus®
	Uni-Telway™
	Character mode
<b>Bus connections</b>	AS-Interface® actuator/sensor bus master V2
	CANopen machine bus master V4.02
	INTERBUS® fieldbus master V2 (5) or Profibus DP™ fieldbus master V0 Class 1 and 2 (5)
<b>Network connections</b>	Max. no. of networks
	Ethernet
	Fipway®/Ethway™/Modbus Plus™ modules
<b>Integrated process control</b>	Configurable loops
	Programmable loops
<b>Hot Standby availability</b>	
<b>Memory capacity</b>	Without PCMCIA extension
	With PCMCIA extension
	Data storage
<b>USB programming port</b>	
<b>Power supply</b>	
<b>Premium processor</b>	Standard
	Integrated Ethernet (9)
	Integrated CANopen
	Integrated Fipio®
<b>Pages</b>	

1 with 4, 6, 8 or 12 slots	4 with 4, 6, or 8 slots or 2 with 12 slots
256 channels (8-, 16-, 32- or 64-channel module)	512 channels (8-, 16-, 32- or 64-channel module)
12 channels (4-, 8- or 16-channel module)	24 channels (4-, 8- or 16-channel module)
4	8
–	
Modules with 2/4 counter channels 1 MHz max., single-channel electronic cam module	
Modules with 1/2 axes for stepper motors, 2/3/4 axes for analog control servo motors, 8/16 axes with SERCOS™ digital link	
Module for 8 load cells (2 application-specific channels)	
TSX SCY in-rack communication modules (1 application-specific channel)	
RS 232, RS 485 or current loop (3) (4) master/slave PCMCIA modules and RS 485 master/slave in-rack communication modules	
1 integrated RS 485 master/slave channel, RS 232, RS 485 or current loop (3) (4) master/slave PCMCIA modules and RS 485 master/slave in-rack communication modules	
1 integrated RS 485 channel, RS 232, RS 485 or current loop PCMCIA modules (3) (4) and RS 485 in-rack communication modules	
1 in-rack module	2 in-rack modules
1 integrated PCMCIA module	1 PCMCIA module (3)
–	
1	
Multiprotocol in-rack modules (Modbus /TCP, Uni-TE™, Global Data, I/O Scanning, TCP Open), Web server, FactoryCast™ server or FactoryCast HMI server	
Fipway module (4), Ethway in-rack modules	Modbus Plus (3), Fipway (3)(4) modules, Ethway in-rack modules
–	
Process control EFB library	
–	
96 Kb program and data	96 Kb program and data
128 Kb program 96 Kb data	224 Kb program 96 Kb data
256 Kb (PCMCIA extension in upper slot (0) on processor)	
–	
100...240 V ~, 24 --- non-isolated and 24...48 V --- isolated power supply. A power supply is required for each rack.	
	<b>TSX P57 104M</b>
	<b>TSX P57 1634M</b> ★
<b>TSX P57 0244M</b>	
	<b>TSX P57 154M</b> (11)
1/12	

(1) The maximum values for the numbers of discrete and analog I/O are cumulative (with the exception of **TSX H57 24M/44M** Hot Standby processors).  
 (2) 1 axis = 1 application-specific channel, except for SERCOS modules where, depending on the configuration, the module = 2...32 channels.  
 (3) Module to be inserted into the lower PCMCIA slot (no. 1).  
 (4) Module to be inserted into the **TSX SCY 21 601** in-rack communication module slot.  
 (5) The **INTERBUS** and **Profibus DP** limits are not cumulative.  
 (11) The **TSX P57 154M** processor does not support the **CANopen** bus PCMCIA module.

**TSX 57 2● processors and slot PLCs    TSX 57 3● processors and slot PLCs    TSX 57 4● processors    TSX 57 5● processors    TSX 57 6● processors**



1 with 6, 8 or 12 slots	16 with 4, 6, or 8 slots or 8 with 12 slots		1 with 6, 8 or 12 slots	16 with 4, 6, or 8 slots or 8 with 12 slots			
512 channels (64-channel modules)	1024 channels (8-, 16-, 32- or 64-channel modules)		512 channels (64-channel modules)	2048 channels (8-, 16-, 32- or 64-channel modules)			
80 channels (16-channel modules)	80 channels (4-, 8- or 16-channel modules)	128 channels (4-, 8- or 16-channel modules)	128 channels (16-channel modules)	256 channels (4-, 8- or 16-channel modules)	512 channels (4-, 8- or 16-channel modules)		
18	24	32	18	64			
–	Modules with 2/4 counter channels, single-channel electronic cam		–	Modules with 2/4 counter channels, single-channel electronic cam			
–	Modules with 1/2 axes for stepper motors, 2/3/4 axes for servo motors, 8/16 axes with SERCOS digital link		–	Modules with 1/2 axes for stepper motors, 2/3/4 axes for servo motors, 8/16 axes with SERCOS digital link			
–	Module for 8 load cells (2 application-specific channels)		–	Module for 8 load cells (2 application-specific channels)			
TSX SCY in-rack communication modules (1 application-specific channel)							
RS 232, RS 485 or current loop (3) (4) master/slave PCMCIA modules and RS 485 master/slave in-rack communication modules							
1 integrated RS 485 master/slave channel, RS 232, RS 485 or current loop (3) (4) master/slave PCMCIA modules and RS 485 master/slave in-rack communication modules							
1 integrated RS 485 channel, RS 232, RS 485 or current loop PCMCIA modules (3) (4) and RS 485 in-rack communication modules							
–	4 in-rack modules	8 in-rack modules	–	8 in-rack modules			
–	1 PCMCIA module (3)		–	1 PCMCIA module (3)			
–	1 in-rack module	3 in-rack modules	–	4 in-rack modules	5 in-rack modules		
2	2 + 1 software gateway	3	3 + 1 software gateway	4			
Multiprotocol in-rack modules (Modbus®/TCP, Uni-TE™, Global Data, I/O Scanning (6), TCP Open), Web server, FactoryCast server or FactoryCast HMI server							
–	Modbus Plus™ (3), Fipway (3)(4) module, Ethway in-rack modules		–	Modbus Plus (3), Fipway (3) (4) (7) module, Ethway in-rack modules			
10 channels with 3 loops max.		15 channels with 3 loops max.		20 channels with 3 loops max.		30 channels with 3 loops max.	
Process control EFB library							
Yes	–		Yes	–			
160/192 Kb program and data (8)		192/208 Kb program and data (8)		440 Kb program and data		1 Mb program and data	2 Mb program and data
768 Kb program 160/192 Kb data (8)		1.75 Mb program 192/208 Kb data (8)		2 Mb program 440 Kb data		7 Mb program 1 Mb data	7 Mb program 2 Mb data
8 Mb (PCMCIA extension in upper or lower slot (0 or 1) on processor)							
–	–		–	1			
100...240 V ~, 24 V = non-isolated and 24...48 V = isolated power supply. A power supply is required for each rack.							

	<b>TSX P57 204M</b>	<b>TSX P57 304M</b>					
<b>TSX H57 24M (10)</b>	<b>TSX P57 2634M</b>	<b>TSX P57 3634M</b>		<b>TSX H57 44M (10)</b>	<b>TSX P57 4634M</b>	<b>TSX P57 5634M</b>	<b>TSX P57 6634M</b>
	<b>TSX P57 254M</b>	<b>TSX P57 354M</b>			<b>TSX P57 454M</b>	<b>TSX P57 554M</b>	
4/69	1/12	1/12	1/21	1/13	4/69	1/13	

(6) **TSX H57 24M/44M Hot Standby processors do not support the Ethernet I/O Scanning service.**  
 (7) **TSX P57 4634M/5634M/6634M processors with integrated Ethernet port do not support the PCMCIA Fipway card.**  
 (8) **The second value applies to TSX P57 254M/354M processors with integrated Fipio link and to the TSX H57 24M Hot Standby processor.**  
 (9) **The integrated Ethernet port requires one of the available network connections.**  
 (10) **The integrated Ethernet port is dedicated to Hot Standby communication (CPU Sync link between "Primary" and "Redundant" processors).**

**n** New feature

# Modicon® Premium™ automation platform Unity™ processors

1



## Presentation

Modicon® Premium™ **TSX™ P57 ●●4M**, **TSX P57 ●●34M** and **TSX H●4M** automation platform processors manage the entire PLC station comprising:

- Discrete I/O modules
- Preventa™ safety modules
- Analog I/O modules
- Application-specific modules (counter, motion, weighing, communication)

- ① The Premium processor offer has seen the addition of three new references:
  - **TSX P57 6634M**, high-end processor with 1 integrated Ethernet Modbus®/TCP port and an internal 2 Mb RAM
  - **TSX H57 24M/44M**, that supports the Hot Standby system (with "Primary" and "Secondary" PLCs), see pages 4/60 to 4/69

The processors differ in terms of their memory capacities, processing speeds, the number of I/O and the number of communication ports.

Depending on the model, they include:

- 1 to 16 racks interconnected by means of Bus X (max. distance: 700 m)
- 192 to 2040 discrete I/O
- 12 to 512 analog I/O
- 4 to 64 application-specific channels. Each application-specific module (counter motion control, communication or weighing) accounts for one or more application-specific channels.
- 1 to 4 networks (Ethernet Modbus/TCP, Fipway®, Modbus Plus™, Etway), 1 to 8 AS-Interface buses
- 0 or 1 Fipio® bus, 0 or 1 CANopen or Modbus Plus bus and 0 to 5 INTERBUS® or Profibus DP™ (1) fieldbuses
- 0 to 30 process control channels, with each channel capable of supporting up to 3 loops

Depending on the model, Premium™ processors also feature:

- A 10BASE-T/100BASE-TX Ethernet Modbus/TCP port (RJ45 connector)
- A 1 Mbit/s Fipio bus link (bus manager)
- Communication via 2 terminal ports (TER and AUX) using Uni-Telway or character mode protocol (typically a 19 or 115 Kbit/s programming terminal and an operator dialog terminal)
- A USB type TER port (for connecting a programming terminal)

Each processor has two slots for a PCMCIA card:

- An upper slot (no. 0) for battery-backed memory extension cards (program, symbols, constants and/or data files)
- A lower slot (no. 1) for (1) a network card (Fipway, Modbus Plus) or bus (CANopen, Fipio Agent, Modbus, Uni-Telway and serial links). Memory extension cards intended specifically for storing data can also be inserted into this slot.

## Treatment for harsh environments

- ① If the Modicon Premium automation platform is destined for use in extremely harsh environments, the "conformal coating" offer is available. This involves applying a coat of "humiseal 1A33" varnish to the electronic cards of the processor and power supply modules, I/O modules on Bus X and the racks. See page 9/2.

## Premium application design and installation

The installation of these Premium processors requires:

- Unity™ Pro Medium, Large or Extra Large programming software. This is the same as the software for installing the Modicon M340 and Modicon Quantum platforms.
- Optionally, depending on requirements:
  - The Unity Application Generator (UAG) specialist software for modelling and generating process applications
  - Unity EFB toolkit software for developing EF and EFB libraries in C language
  - Unity SFC View software for visualizing and diagnosing applications written in Sequential Function Chart (SFC) or Grafcet language

(1) **TSX H57 24M/44M** Hot Standby processors do not support the following buses or networks: Fipio, CANopen, Modbus Plus, INTERBUS and Profibus DP.

① New feature

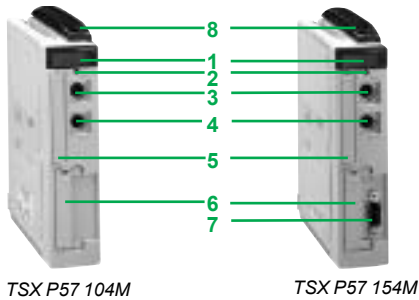

TSX P57 104M

TSX P57 154M

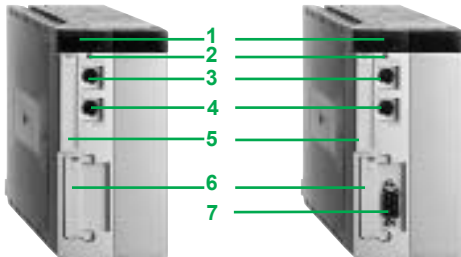

TSX P57 204M/304M

TSX P57 254M/354M/454M

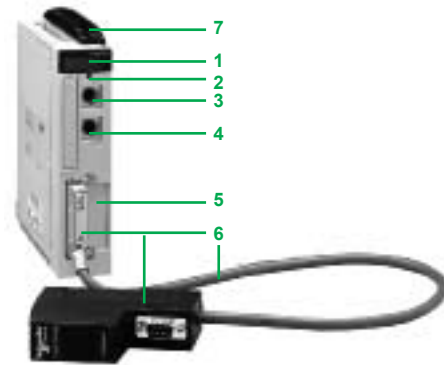

TSX P57 0244M

### TSX™ P57●●4M processors without integrated Ethernet port

TSX P57 1●4M single-format processors and TSX P57 2●4/3●4M double-format processors feature the following on the front panel:

- 1 A display block with 5 LEDs:
  - RUN LED (green): Processor in operation (program running)
  - ERR LED (red): Controller detected fault on the processor or its on-board devices (PCMCIA memory card and PCMCIA communication card)
  - I/O LED (red): Controller detected fault occurring on another station module or configuration fault
  - TER LED (yellow): Activity on TER or AUX terminal port
  - FIP LED (red): Activity on integrated Fipio® bus (depending on model)
- 2 RESET button causing a cold restart of the PLC when it is activated
- 3 An 8-way female mini-DIN connector marked TER for connecting a programming or adjustment terminal (RS 485)
- 4 An 8-way female mini-DIN connector marked AUX for connecting a programming, adjustment or operator dialog terminal (RS 485)
- 5 A PCMCIA slot (no. 0) for a memory card
- 6 A PCMCIA slot (no. 1) for a communication card or memory extension card for storing additional data
- 7 A 9-way SUB-D connector (on TSX P57 154/254/354M models) for Fipio bus communication (Fipio manager port)
- 8 An air recirculating heatsink (on TSX P57 0244/1●4M models)

### Processor with integrated CANopen port

The TSX P57 0244M processor features:

- 1 A display block with 4 LEDs:
  - RUN LED (green): Processor in operation (program running)
  - ERR LED (red): Controller detected fault on the processor or its on-board devices (PCMCIA memory card and PCMCIA communication card)
  - I/O LED (red): Controller detected fault occurring on another station module or configuration fault
  - TER LED (yellow): Activity on TER or AUX terminal port
- 2 RESET button causing a cold restart of the PLC when it is activated
- 3 An 8-way female mini-DIN connector marked TER for connecting a programming or adjustment terminal (RS 485)
- 4 An 8-way female mini-DIN connector marked AUX for connecting a programming, adjustment or operator dialog terminal (RS 485)
- 5 A PCMCIA slot (no. 0) for a memory card
- 6 A PCMCIA slot (no. 1) equipped with PCMCIA CANopen master V4.02 card, complete with cordset and tap junction (see page 5/65)
- 7 An air recirculating heatsink.

1

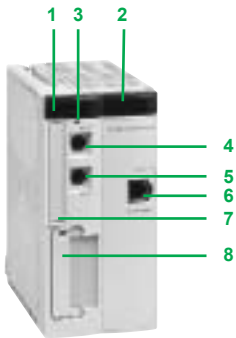

TSX P57 1634M/2634M/3634M

### TSX™ P57 ●●34M processors with integrated Ethernet port

**TSX P57 1634M/2634M/2834M** double-format processors with integrated Ethernet Modbus®/TCP port feature, on the front panel:

- 1** A display block with 5 LEDs:
  - RUN LED (green): Processor in operation (program running)
  - ERR LED (red): Controller detected fault on the processor or its on-board devices (PCMCIA memory card and PCMCIA communication card)
  - I/O LED (red): Controller detected fault occurring on another station module or configuration fault
  - TER LED (yellow): Activity on TER or AUX terminal port
- 2** A display block relating to the integrated Ethernet port featuring 5 LEDs:
  - RUN LED (green): Ethernet port ready
  - ERR LED (red): Ethernet port operative
  - COL LED (red): Collision detection
  - STS LED (yellow): Ethernet link diagnostics
  - Two TX and RX LEDs (yellow): Transmission/reception activity
- 3** RESET button causing a cold restart of the PLC when it is activated
- 4** An 8-way female mini-DIN connector marked TER for connecting a programming or adjustment terminal (RS 485)
- 5** An 8-way female mini-DIN connector marked AUX for connecting a programming, adjustment or operator dialog terminal (RS 485)
- 6** An RJ45 connector for connection to the Ethernet Modbus/TCP 10BASE-T/100BASE-TX network
- 7** A PCMCIA slot (no. 0) for a memory card
- 8** A PCMCIA slot (no. 1) for a communication card or memory extension card for storing additional data

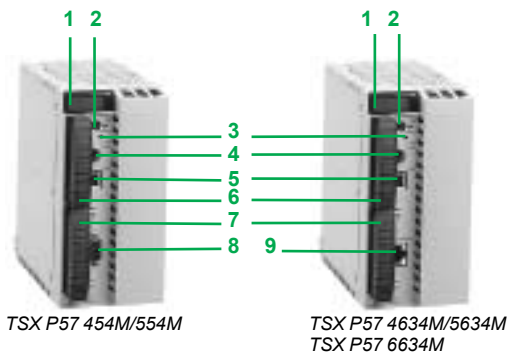

### TSX™ P57 4●4/5●4/6634M and TSX H57 ●4M high-performance processors (1)

Modicon® Premium™ double-format high-performance processors **TSX P57 454/554M/4634M/5634M/6634M** and **TSX H57 24M/44M** (1) feature the following on the front panel:

- 1 A display block with 5 LEDs:
- RUN LED (green): Processor in operation (program running)
  - ERR LED (red): Controller detected fault on the processor or its on-board devices (PCMCIA memory card and PCMCIA communication card)
  - I/O LED (red): Controller detected fault occurring on another station module or configuration fault
  - TER LED (yellow): Activity on the AUX terminal port
  - FIP LED (red): Activity on integrated Fipio bus (TSX P57 454/554M model)

In the case of models with an integrated Ethernet port

(**TSX P57 4634M/5634M/6634M**), this display block features 6 additional LEDs:

- RUN LED (green): Ethernet port ready
- ERR LED (red): Ethernet port inoperative
- COL LED (red): Collision detection
- STS LED (yellow): Ethernet link diagnostics

Two TX and RX LEDs (yellow): Transmission/reception activity

- 2 A "Memory extract" button for extracting the PCMCIA memory extension card. The associated "Memory extract ready" LED indicates that this card can be extracted safely.
- 3 RESET button causing a cold restart of the PLC when it is activated
- 4 An 8-way female mini-DIN connector marked AUX for connecting a programming, adjustment or operator dialog terminal
- 5 A USB type connector marked TER for connecting a programming terminal (requires the PC-compatible 3 m connection cable, reference **UNY XCA USB 033**, to be ordered separately)
- 6 A PCMCIA slot (no. 0) for a memory extension card
- 7 A PCMCIA slot (no. 1) for a communication card or memory extension card for storing additional data
- 8 A 9-way SUB-D connector (on TSX P57 454M/554M models) for Fipio bus communication (Fipio manager port)
- 9 An RJ45 connector (on TSX P57 4634M/5634M/6634M models) for connection to the Ethernet Modbus/TCP 10BASE-T/100BASE-TX network

#### USB port

The USB port **5** boasts a faster useful data rate (12 Mbit/s) than the Uni-Telway terminal port available on Premium processors. The USB port is compatible with Unity Pro programming software and the OPC Factory Server (OFS).

**TSX P57 4●4M/5●4M/6634M** processors can be connected to a USB bus comprising several peripheral devices. However:

- Only one processor must be connected to the USB bus
- No device on the USB bus (modem, printer) can be controlled by the PLC.

(1) **TSX H57 24M/44M** Hot Standby processor, see description on page 4/61.

Processor without PCMCIA memory card

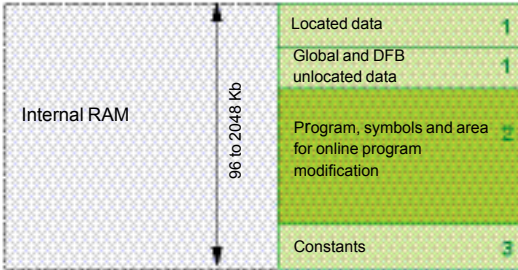

Processor with PCMCIA memory card in slot no. 0

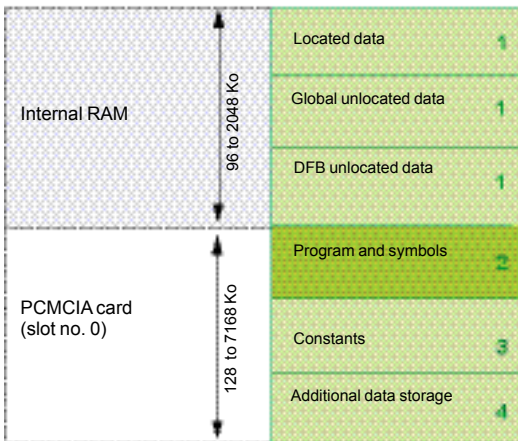

Processor with data storage type memory card in slot no. 0

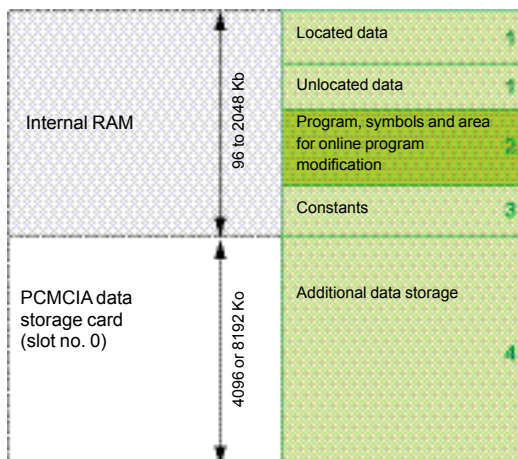

**Memory structure**

The application memory is divided into memory areas, that are physically distributed across the internal RAM and 0, 1 or 2 PCMCIA memory extension cards:

- The application data that is in the internal RAM, is divided into two possible types:
  - Located data, corresponding to data defined by an address (e.g. %MW237), that can have a symbol linked to it (e.g. Counter\_rejects).
  - Unlocated data, corresponding to data defined only by a symbol. This type of addressing eliminates the problems of memory mapping management, because addresses are assigned automatically. It also facilitates data structuring.
  - DFB unlocated data, corresponding to DFB user function block data. The size of this area is determined by the physical size of the available internal RAM. The available RAM depends on the processor model, see pages 1/12 and 1/13.
- Area in internal RAM or PCMCIA memory card for the program and symbols. If this area happens to be inside the internal RAM, it also contains the area for modifying the program in online mode (1). This area contains the program's executable binary code and IEC source code. The user selects the type of information to be stored in the PLC memory.
- Constants area in the internal RAM or the PCMCIA memory card (slot no. 0)
- Area for storing additional data (slot no. 0 or no. 1), e.g. for production data and manufacturing recipes

**Memory organization**

The memory will be organized in one of two ways, depending on whether the Premium processor is fitted with 0, 1 or 2 memory extension cards:

- Application in internal RAM: In this case, the application is completely loaded into the processor's internal battery-backed RAM (2), the capacity depends on the processor model (96 Kb to 2 Mb).
- Application in PCMCIA card: In this case, the internal RAM is reserved for the application data. The PCMCIA memory card (slot no. 1) contains the program space (program, symbols and constants areas) (128 Kb to 2 Mb). Certain types of PCMCIA memory card also host the data storage area (max. 6976 Kb).

**Symbols areas**

Having the symbols area in the same place as the program area is optional. However, if the application symbols database is available on the PLC, it means that, when an empty programming terminal is connected to the PLC, the elements needed to debug or upgrade this PLC can be transferred to the terminal.

(1) If a PCMCIA card has been inserted, it is the memory on this memory card that will be used for the purpose of modifying the program in online mode (outside areas 2, 3 and 4 opposite).  
 (2) The internal RAM is backed up by an optional battery (with a service life of 3 years). The battery is located in the power supply module (see page 2/4).



Processor with mixed type memory card in slot no. 0 and data storage type memory card in slot no. 1 (1)

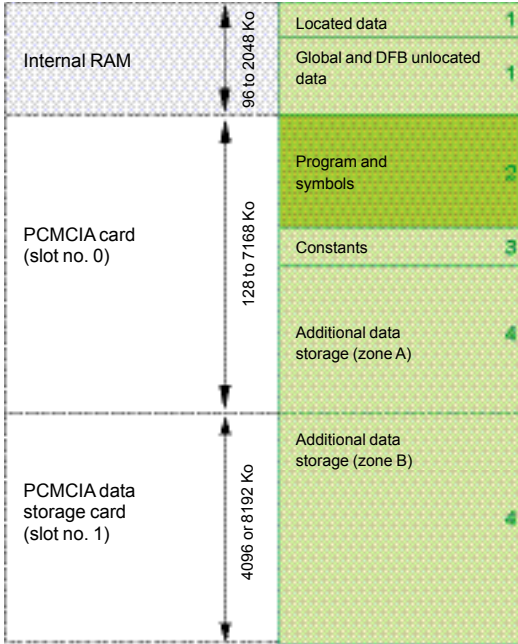

(1) TSX P57 20 processors and higher

**Memory structure (continued)**

**Extension of the data storage area**

Memory cards reserved for data storage (4096 or 8192 Kb) are used to:

- Access the data storage area in cases where the application is fully loaded into the internal RAM. In this case, the data storage memory card is inserted into PCMCIA slot no. 0.
- Free up memory to serve as additional program space when the application is on the PCMCIA card (slot no. 0). In this case, the data storage memory card is inserted into PCMCIA slot no. 1 (although the memory card in slot no. 0 can still be used for some of the data).

Unity™ Pro programming software helps the application designer to manage the structure and organize how the memory space on the Premium PLC is occupied.

**Protecting the application**

Regardless of the PLC memory structure (whether the application is located in the internal RAM or on the PCMCIA card), it is possible to prevent the application from being accessed (for the purpose of reading or modifying the program) by only loading the executable code into the PLC.

A memory protection bit, set in configuration mode, is also available to prevent any program modification (via the programming terminal or downloads).

**Program modification in online mode**

This function is different from previous versions of Modicon® Premium™ PLCs (with PL7 software) in that it now allows program code and data from different parts of the application to be added or modified in a single modification session (thus making modification unified and consistent with regard to the controlled process).

This increased flexibility comes at a cost in terms of the amount of program memory required. In order for the program to be modified in online mode, the amount of program memory space available must be at least equal to the combined size of the sections of the Unity Pro program affected by the single modification session concerned.

Depending on circumstances:

- In the case of a processor with a memory extension card, there will be sufficient memory left on the card for online modification, provided that the recommendations on page 1/22 are observed.
- In the case of a processor without a memory extension card, if the user wants to be able to make modifications in online mode, he or she must select a processor on the basis of the following:
  - The anticipated size of the application
  - The number and size of the program sections to be modified in online mode

**Note:** A memory extension card based exclusively on Flash EPROM technology (without additional SRAM) is clearly incapable of supporting online program modifications.

1

Modicon® Premium™ PLCs have been developed to comply with major national and international standards on electronic industrial automation equipment. See pages 9/8 to 9/19 "Standards, certification and environmental conditions".

**Characteristics and performance**

Types of processor			TSX P57 0244M	TSX P57 104M	TSX P57 1634M	TSX P57 154M	TSX P57 204M	TSX P57 2634M (1)	TSX P57 254M	
<b>Maximum configuration</b>	No. of racks	4/6/8 slots	1	4			16			
		12 slots	1	2			8			
	Max. no. of slots for modules		12	32			128			
<b>Functions</b>	Max. no in-rack (3)	Discrete I/O	192/256 (2)	512			1024			
		Analog I/O	12	24			80			
		Process control channels					10 (up to 30 parameterizable simple loops)			
		Programmable loops via EFB control blocks (with Unity™ Pro Large and Extra Large)								
		Application-specific channels, number	4	8			24			
		Application-specific channels, type	Counter, axis control, weighing and serial links (Modbus®, Uni-Telway™ and asynchronous)							
	Integrated connections	Ethernet			1			1		
		Fipio® manager					1 (63 agents)		1 (127 agents)	
		Serial link	1 link with 2 connectors (TER and AUX) 19.2 Kbit/s							
	Max. no. of connections	Network (Ethernet, Fipway®, Ethway, Modbus Plus™)		1	1 integrated Ethernet port	1	2	3 including 1 integrated Ethernet port	2	
AS-Interface® bus			1	2			4			
CANopen or Modbus Plus bus			1 integrated CANopen	1		1 Modbus Plus only	1			
INTERBUS® or Profibus DP™ bus							1			
<b>Memories</b>	Maximum capacity	Without PCMCIA card	<b>Kb</b>	96 prog. + data			160 prog. + data	192 prog. + data		
		With PCMCIA card	<b>Kb</b>	128 prog. 96 data	224 prog. 96 data		768 prog. 160 data	768 prog. 192 data		
		Data storage	<b>Kb</b>	256				16,384 (limited to 8192 with current PCMCIA cards)		
	Maximum size of object zones	Located internal bits (%Mi)	<b>bits</b>	4096				8132		
		Located internal data	<b>Kb</b>	64 for internal words %M <i>i</i> 64 for constant words %K <i>i</i>						
		Unlocated internal data	<b>Kb</b>	Elementary EDT and derived DDT data: 32 Kb				Elementary EDT and derived DDT data: 64 Kb		
			DFB and EFB function blocks: Size per instance: 64 Kb, unlimited number of instances (7)							
<b>Application structure</b>	Tasks	Master		1			1			
		Fast		1			1			
		Auxiliary								
		Event-triggered		32 (1 has priority)			64 (1 has priority)			
<b>Execution time for one instruction</b>	Without PCMCIA card	Boolean	<b>µs</b>	0.19	0.19		0.19			
		On word or fixed-point arithmetic	<b>µs</b>	0.25	0.25		0.25			
		On floating points	<b>µs</b>	1.75...2.60 (7)	1.75...2.60 (7)		1.75...2.60 (7)			
	With PCMCIA card	Boolean	<b>µs</b>	0.25	0.25		0.21			
		On word or fixed-point arithmetic	<b>µs</b>	0.50	0.50		0.42			
		On floating points	<b>µs</b>	1.75...2.60 (7)	1.75...2.60 (7)		1.75...2.60 (7)			
<b>No. of Kinstructions executed every ms</b>	Without PCMCIA card	100% Boolean	<b>Kinst/ms</b>	4.76	4.76		4.76			
		65% Boolean and 35% fixed arithmetic	<b>Kinst/ms</b>	3.71	3.71		3.71			
	With PCMCIA card	100% Boolean	<b>Kinst/ms</b>	3.10	3.10		3.70			
		65% Boolean and 35% fixed arithmetic	<b>Kinst/ms</b>	2.10	2.10		2.53			
<b>System overhead</b>	Tasks	Master	<b>ms</b>	1.00	1.00		1.00			
		Fast	<b>ms</b>	0.30	0.30		0.30			

(1) For details of TSX H57 4M processor characteristics and performance, see page 4/68.

(2) The first value applies to the TSX P57 C 0204M configuration and the second to the TSX P57 0244M processor.

(3) Only affects in-rack modules. The maximum values for the number of discrete I/O, analog I/O, application-specific channels and process control channels are cumulative. The remote I/O on the bus or network (Ethernet, CANopen, AS-Interface, Uni-Telway, Fipio, Modbus Plus, etc.) or third-party bus (INTERBUS or Profibus DP) are not included in these maximum numbers.

Modicon® Premium™ PLCs have been developed to comply with major national and international standards on electronic industrial automation equipment. See pages 9/8 to 9/18 "Standards, certification and environmental conditions".

### Characteristics and performance (continued)

Types of processor			TSX P57 304M	TSX P57 3634M	TSX P57 354M	TSX P57 454M	TSX P57 4634M (1)	TSX P57 554M	TSX P57 5634M 6634M		
<b>Maximum configuration</b>	No. of racks	4/6/8 slots	16			16		16			
		12 slots	8			8		8			
		Max. no. of slots for modules	128			128		128			
<b>Functions</b>	Max. no in-rack (3)	Discrete I/O	1024			2040		2040			
		Analog I/O	128			256		512			
		Process control channels	15 (up to 45 parameterizable simple loops)			20 (up to 60 parameterizable simple loops)		30 (up to 90 parameterizable simple loops)			
		Programmable loops via EFB control blocks (with Unity™ Pro Large and Extra Large)									
		Application-specific channels, number	32			64		64			
		Application-specific channels, type	Counter, axis control, weighing and serial links (Modbus®, Uni-Telway and asynchronous)								
	Integrated connections	Ethernet		–	1	–	1	–	1		
		Fipio® manager		–	1 (127 agents)			–	1 (127 agents)	–	
		Serial link		1 link with 2 connectors (TER and AUX) 19.2 or 115 Kbit/s			1 x 12 Mbit/s USB link (TER), 1 x 19.2 Kbit/s (AUX) link				
	Max. no. of connections	Network (Ethernet, Fipway®, Ethway™, Modbus Plus™)		3	3 including 1 integrated Ethernet port	3	4	4 including 1 integrated Ethernet port (4)	4	4 including 1 integrated Ethernet port (4)	
AS-Interface® bus			8			8		8			
CANopen or Modbus Plus bus			1								
INTERBUS® or Profibus DP™ bus			3			4		5			
<b>Memories</b>	Maximum capacity	Without PCMCIA card	<b>Kb</b>	192 prog. + data		208 prog. + data	440 prog. + data		1024/2048 (5) prog. + data		
		With PCMCIA card	<b>Kb</b>	1792 prog. 192 data		1792 prog. 208 data	2048 prog. 440 data		7168 prog. 1024/2048 data (5)		
		Data storage	<b>Kb</b>	16,384 (limited to 8192 with current PCMCIA cards)							
	Maximum size of object zones	Located internal bits (%Mi)	<b>bits</b>	16,384			32,768		32,768		
		Located internal data	<b>Kb</b>	64 for internal words %M <i>i</i> 64 for constant words %K <i>i</i>						128 for int. words %M <i>i</i> 64 for const. words %K <i>i</i>	
		Unlocated internal data	<b>Kb</b>	Elementary EDT and derived DDT data: 64 Kb			Elementary EDT and derived DDT data: Unlimited (6)				
			DFB and EFB function blocks: - Size per instance: 64 Kb - Unlimited number of instances (6)			DFB and EFB function blocks: - Size per instance: unlimited (6), - Unlimited number of instances (6)					
<b>Application structure</b>	Tasks	Master		1			1		1		
		Fast		1			1		1		
		Auxiliary		–			–		4		
		Event-triggered		64 (1 has priority)			64 (1 has priority)		128 (1 has priority) 32 (timers)		
<b>Execution time for one instruction</b>	Without PCMCIA card	Boolean	<b>µs</b>	0.12			0.039...0.057 (7)		0.0375...0.045 (7)		
		On word or fixed-point arithmetic	<b>µs</b>	0.17			0.054...0.073 (7)		0.045...0.060 (7)		
		On floating points	<b>µs</b>	1.75...3.00 (7)			0.55...0.63 (7)		0.48...0.56 (7)		
	With PCMCIA card	Boolean	<b>µs</b>	0.17			0.048...0.057 (7)		0.0375...0.045 (7)		
		On word or fixed-point arithmetic	<b>µs</b>	0.32			0.054...0.073 (7)		0.045...0.060 (7)		
		On floating points	<b>µs</b>	1.75...3.00 (7)			0.55...0.63 (7)		0.48...0.56 (7)		
<b>Typical program code execution time for 1 Kinstruction</b>	Without PCMCIA card	100% Boolean	<b>Kinst/ms</b>	6.72			15.75		20.26		
		65% Boolean and 35% fixed arithmetic	<b>Kinst/ms</b>	5.11			11.40		14.00		
	With PCMCIA card	100% Boolean	<b>Kinst/ms</b>	4.59			15.75		20.26		
		65% Boolean and 35% fixed arithmetic	<b>Kinst/ms</b>	3.11			11.40		14.00		
<b>System overhead</b>		Master task	<b>ms</b>	1.00			1.00		1.00		
		Fast task	<b>ms</b>	0.35			0.08		0.07		

(4) TSX FPP 20 PCMCIA Fipway card not supported.

(5) The first value applies to TSX P57 554M/5634M processors and the second to the TSX P57 6634M processor.

(6) Within the limits of the processor's data memory capacity

(7) Values limited according to type of instruction.

1



TSX P57 0244M



TSX P57 1634M



TSX P57 2634M/3634M



TSX P57 154M/254M/354M

### TSX™ 57 processors

I/O capacity (1)	Capacity		Maximum number of bus/network modules	Integrated port	Reference	Weight kg
	Memory	Control channels				
<b>TSX 57 0● 1 rack</b>						
256 discrete I/O 12 analog I/O 4 application-specific channels	96 Kb integrated 128 Kb on PCMCIA	0	1 network 1 AS-Interface® bus	CANopen	<b>TSX P57 0244M</b>	0.320
<b>TSX 57 1● 4 racks (2)</b>						
512 discrete I/O 24 analog I/O 8 application-specific channels	96 Kb integrated 224 Kb max. on PCMCIA	0	1 network 2 AS-Interface buses 1 CANopen bus	–	<b>TSX P57 104M</b>	0.380
			2 AS-Interface buses 1 CANopen bus	Ethernet	<b>TSX P57 1634M</b>	–
			1 network 2 AS-Interface buses	Fipio	<b>TSX P57 154M</b>	0.420
<b>TSX 57 2● 16 racks (2)</b>						
1024 discrete I/O 80 analog I/O 24 application-specific channels	160 Kb integrated 768 Kb max. on PCMCIA	10	2 networks 4 AS-Interface buses 1 CANopen bus (3) 1 fieldbus (3)	–	<b>TSX P57 204M</b>	0.520
			1 network 4 AS-Interface buses 1 CANopen bus (3) 1 fieldbus (3)	Ethernet	<b>TSX P57 2634M</b>	–
	192 Kb integrated 768 Kb max. on PCMCIA	10	2 Ethernet networks	Ethernet dedicated to Hot Standby	<b>TSX H57 24M</b>	0.560
			2 networks 4 AS-Interface buses 1 CANopen bus (3) 1 fieldbus (3)	Fipio	<b>TSX P57 254M</b>	–
<b>TSX 57 3● 16 racks (2)</b>						
1024 discrete I/O 128 analog I/O 32 application-specific channels	192 Kb integrated 1792 Kb max. on PCMCIA	15	3 networks 8 AS-Interface buses 1 CANopen bus (3) 3 fieldbuses (3)	–	<b>TSX P57 304M</b>	0.520
			2 networks 8 AS-Interface buses 1 CANopen bus (3) 3 fieldbuses (3)	Ethernet	<b>TSX P57 3634M</b>	–
	208 Kb integrated 1792 Kb max. on PCMCIA	15	3 networks 8 AS-Interface buses 1 CANopen bus (3) 3 fieldbuses (3)	Fipio	<b>TSX P57 354M</b>	0.560

(1) Cumulative maximum values. The number of remote I/O on the various buses is not taken into account.  
 (2) Maximum number of TSX RKY 4EX/6EX/8EX racks (4, 6 or 8 slots). Using the TSX RKY 12 EX rack (12 slots) is the same as using 2 racks with 4, 6 or 8 slots.  
 (3) Fieldbus: INTERBus or Profibus DP.

**TSX™ 57 processor** (continued)

I/O capacity (1)	Capacity		Maximum number of bus/network modules	Integrated port	Reference	Weight kg
	Memory	Control channels				
<b>TSX 57 4● 16 racks (2)</b>						
2040 discrete I/O 256 analog I/O 64 application-specific channels	440 Kb	20	3 networks 8 AS-Interface® buses 1 CANopen bus (3) 4 fieldbuses (3)	Ethernet	<b>TSX P57 4634M</b>	0.610
	integrated 2048 Kb max. on PCMCIA		4 networks Ethernet	Ethernet dedicated to Hot Standby	<b>TSX H57 44M</b>	0.610
			4 networks 8 AS-Interface buses 1 CANopen bus 4 fieldbuses (3)	Fipio	<b>TSX P57 454M</b>	0.560



TSX P57 454M/554M

**TSX 57 5● 16 racks (2)**

2040 discrete I/O 512 analog I/O 64 application-specific channels	1 Mb integrated	30	3 networks 8 AS-Interface buses 1 CANopen bus 5 fieldbuses (3)	Ethernet	<b>TSX P57 5634M</b>	0.610
	7168 Kb max. on PCMCIA		4 networks 8 AS-Interface buses 1 CANopen bus 5 fieldbuses (3)	Fipio	<b>TSX P57 554M</b>	0.560



TSX P57 4634M/5634M/6634M

**TSX 57 6● 16 racks (2)**

2040 discrete I/O 512 analog I/O 64 application-specific channels	2 Mb integrated	30	3 networks 8 AS-Interface buses 1 CANopen bus 5 fieldbuses (3)	Ethernet	<b>TSX P57 6634M</b>	0.610
---	-----------------	----	---	----------	----------------------	-------

**PCMCIA memory extension cards**

Modicon® Premium™ processors can support up to 2 memory extension cards. However, useful memory capacity is limited to the maximum size defined for the processor model. See pages 1/22 and 1/23

**Connection cables for PC programming terminal**

Description	Use		Length	Reference	Weight kg
	From terminal port	To PC			
<b>Universal cable for terminal port/RS 232 port</b>	Mini-DIN (TER or AUX) on:	RS 232D port	2.5 m	<b>TSX PCX 1031</b>	0.170
	TSX Micro Premium™ TSX P57 0●/1● Premium TSX P57 2●/3● Tap junction TSX P ACC 01	(9-way SUB-D)			
<b>Cable for terminal port/USB port</b>	Mini-DIN (TER or AUX) on:	USB port	0.4 m	<b>TSX CUSB 485</b>	0.144
	TSX Micro Premium TSX P57 0●/1● Premium TSX P57 2●/3● Tap junction TSX P ACC 01	(USB/RS 485 converter)	2.5 m	<b>TSX CRJMD 25</b>	0.150
	USB (TER) on:	USB port on a PC terminal	3.3 m	<b>UNY XCA USB 033</b>	–
	Premium TSX 57 4●/5● Quantum™ 140 CPU 6●1				



TSX PCX 1031



TSX CUSB 485

(1) Product supplied with a multilingual Quick Reference Guide.

(2) Maximum number of **TSX RKY 4EX/6EX/8EX** racks (4, 6 or 8 slots). Using the **TSX RKY 12 EX** rack (12 slots) is the same as using 2 racks with 4, 6 or 8 slots.

(3) Fieldbus: *INTERBUS* or *Profibus DP*.

(4) The **TSX CUSB485** converter requires the use of cable **TSX CRJMD 25** (length 2.5 m, equipped with 1 mini-DIN connector and 1 RJ45 connector).

# Modicon® Premium™ automation platform

## PCMCIA memory extension cards

### Unity™

1



PCMCIA SRAM memory card



PCMCIA Flash EPROM memory card

### Presentation

PCMCIA memory extension cards are used to extend the internal RAM capacity of Modicon® Premium™ processors. Some of the cards can also be used on Modicon® Quantum™ and Micro™ processors. Depending on the model, these cards can host:

- Application program, symbols and constants
- Additional application data
- Or both

### PCMCIA memory extension cards

The cards are inserted into PCMCIA slot no. 0 on Premium processors, i.e.:

- The upper slot on processors
- The internal slot on slot PLCs

Two of these SRAM data storage memory cards can also be inserted into slot no. 1, i.e.:

- The lower slot on processors
- The external slot on slot PLCs

These cards support three types of data storage:

- Application storage: Program, symbols and constants in a common space (128 Kb to 7168 Kb, depending on the card model):
  - **TSX™ MRP P●●●K** for SRAM memories
  - **TSX™ MFP P●●●K/M** for Flash EPROM memories
  - Storage of the application and additional data, with 192 Kb to 7 Mb of application space and 7 Mb to 0 Kb of data storage space for additional data. The limit between these 2 spaces is configurable. The configurable cards are:
    - **TSX MRP C●●●K/M** for SRAM memories
    - **TSX™ MCP C●●●K/M** for Flash EPROM and SRAM memories
  - Storage of additional data, provided by 4 Mb or 8 Mb **TSX MRP F00●M** SRAM memory cards

These cards use 2 technologies:

#### ■ Battery-backed SRAM

Used in particular in the creation and debugging phases for the application program. These cards support:

- The application's transfer and modification services in online mode
- Additional data storage

The memory is backed up by a removable battery integrated into the PCMCIA card. A second auxiliary battery is present to enable the main battery to be replaced without loss of data.

#### ■ Flash EPROM

Used once debugging of the application program is complete. It enables:

- Backup battery life restrictions to be overcome
- A global application transfer to be performed

If it is used, the application cannot be modified in online mode.

### Program modification in online mode

Only extension cards on which the program is stored in SRAM memory (TSX MRP P●●●K/M and TSX MRP C●●●K/M) support online program modification.

Users of processors fitted with memory extension cards who wish to modify or add program data in online mode must follow the two recommendations below:

- Structure the application program in a number of sections of a reasonable size
- Where possible, select one of the two extension cards recommended in the table below:

Modicon® Premium™ processors	TSX™ P57 0●	TSX P57 1●	TSX P57 2● TSX PCI 57 2●	TSX P57 3● TSX PCI 57 3●	TSX P57 4●	TSX P57 5●	TSX P57 6●
Cards recommended for program modification in online mode	TSX MRP P●●●K and TSX MRP C●●●K/M/7	TSX MRP P224K/P384K, TSX MRP C●●●K/M/7	TSX MRP C●●●K/M/7		TSX MRP C002M, TSX MRP C003M, TSX MRP C007M		

#### Memory capacities of processors and slot PLCs

Memory capacities without PCMCIA extension card (data, program, symbols, and constants in internal RAM memory):

Modicon® Premium™ processors	TSX™ P57 0244M	TSX P57 104/154M/1634M	TSX 57 204/2634M	TSX™ PCI 57 204M	TSX P57 254	TSX P57 304/3634M	TSX P57 354M	TSX PCI 57 354M	TSX P57 454/4634M	TSX P57 554/5634M	TSX P57 6634M
In internal RAM	96 Kb	160 Kb	192 Kb	192 Kb	208 Kb	440 Kb	1024 Kb	2048 Kb			

Memory capacities with PCMCIA extension card(s) (data in internal RAM memory; program, symbols, constants, and data storage on PCMCIA card):

Premium™ processors	TSX P57 0244M	TSX P57 104/154M/1634M	TSX 57 204/2634M	TSX PCI 57 204M	TSX P57 254	TSX P57 304/3634M	TSX P57 354M	TSX PCI 57 354M	TSX P57 454/4634M	TSX P57 554/5634M	TSX P57 6634M
Data in internal RAM	96 Kb	160 Kb	192 Kb	192 Kb	208 Kb	440 Kb	1024 Kb	2048 Kb			
PCMCIA extension (progr., symbols and constants)	128 Kb	224 Kb	768 Kb	768 Kb	1792 Kb	1792 Kb	2048 Kb	7168 Kb	7168 Kb	7168 Kb	
Data storage on PCMCIA (1)	256 Kb	16,384 Kb, limited to 8192 Kb if the TSX MRP F008M PCMCIA card is used									

#### PCMCIA memory extension cards

Premium processors support the memory extension cards listed below. There are two types of memory limit:

- One associated with the type of processor or slot PLC (see above)
- One associated with the model of PCMCIA memory card selected

The lowest of these two limits defines the memory capacity available to the user for his/her application.

Use on processor	Slot	Memory size		Reference	Weight kg
		Application	Additional data		
<b>SRAM application memory extensions</b>					
TSX™ P57 0●...57 4●	Slot 0	128 Kb	–	TSX™ MRP P128K	0,076
TSX™ PCI 57 2●/3●		224 Kb	–	TSX MRP P224K	0,076
		384 Kb	–	TSX MRP P384K	0,076
<b>Configurable SRAM application/additional data memory extensions</b>					
TSX P57 0●...57 4●/PCI 57 2●/3●	Slot 0	96...448 Kb	352...0 Kb	TSX MRP C448K	0,076
TSX 57 0●...57 6●	Slot 0	192...768 Kb	576...0 Kb	TSX MRP C768K	0,076
TSX PCI 57 2●/3●		192...1024 Kb	832...0 Kb	TSX MRP C001M	0,076
		192...1792 Kb	1600...0 Kb	TSX MRP C01M7	0,076
		192...2048 Kb	1856...0 Kb	TSX MRP C002M	0,076
		192...3072 Kb	2880...0 Kb	TSX MRP C003M	0,076
		192...7168 Kb	6976...0 Kb	TSX MRP C007M	0,076
<b>Flash EPROM application memory extensions</b>					
TSX P57 0●...57 4●	Slot 0	128 Kb	–	TSX™ MFP P128K	0,044
TSX PCI 57 2●/3●		224 Kb	–	TSX MFP P224K	0,044
		384 Kb	–	TSX MFP P384K	0,044
TSX P57 0●...57 6●	Slot 0	512 Kb	–	TSX MFP P512K	0,044
TSX PCI 57 2●/3●		1024 Kb	–	TSX MFP P001M	0,044
TSX P57 2●...57 6●	Slot 0	2048 Kb	–	TSX MFP P002M	0,044
TSX PCI 57 2●/3●		4096 Kb	–	TSX MFP P004M	0,044
<b>Flash EPROM and SRAM application/additional data memory extensions</b>					
TSX P57 0●...57 4●	Slot 0	224 Kb	256 Kb	TSX™ MCP C224K	0,076
TSX PCI 57 2●/3●					
TSX P57 0●...57 6●	Slot 0	512 Kb	512 Kb	TSX MCP C512K	0,076
TSX PCI 57 2●/3●		2048 Kb	1024 Kb	TSX MCP C002M	0,076
<b>SRAM additional data memory extensions</b>					
TSX P57 2●...57 6●	Slot 0 or 1	–	4096 Kb	TSX MRP F004M	0,076
TSX PCI 57 2●/3●		(2)	–	8192 Kb	TSX MRP F008M
<b>Flash EPROM backup card (3)</b>					
TSX 57 0●/1●	Slot 0	96 Kb	–	TSX MFP B096K	0,044
<b>Handle to remove memory card for high-performance processors</b>					
Description	Use	Slot of processor		Reference	Weight kg
Handles (not provided with the memory card)	Remove PCMCIA memory card for TSX P57 4●...57 6●	No. 0 (upper slot)	No. 1 (lower slot)	TSX™ P CAPUP	0,012
				TSX P CAPL	0,012
<b>Replacement parts</b>					
Description	Use	Type	Reference	Weight kg	
Backup batteries	PCMCIA SRAM memory card	Main	TSX™ BAT M02 (4)	0.010	
		Auxiliary	TSX BAT M03	0.005	
Handle (provided with the memory card)	Remove PCMCIA memory card for TSX P57 0●...57 3●	–	TSX P CAP	0.010	

(1) Intended for the storage of manufacturing recipes and production data. Capacity depending on PCMCIA card model.

(2) Memory extension card for file storage to be inserted into slot no. 0 if free, otherwise into slot no. 1. In the latter case, an application memory type or application memory and file storage type memory extension card is inserted into slot no. 0.

(3) This card is pre-loaded and can be used to update the application program on a Premium PLC without having to use a programming terminal (the entire program must be located in the internal RAM).

(4) TSX BAT M02 with PCMCIA card PV ≥ 04 (blue), for PCMCIA card PV < 04, please order TSX BAT 01 reference.

# Modicon® Premium™ automation platform

## Premium processors

### PL7™

1

Modicon® Premium™ platforms for PL7™ software offer

TSX™ 57 1● processors

TSX 57 2● processors



<b>Number of racks</b> (according to rack type)		4 with 4, 6, or 8 slots or 2 with 12 slots	16 with 4, 6, or 8 slots or 8 with 12 slots
<b>In-rack I/O</b> (1)	Discrete I/O	512 channels (8-, 16-, 32- or 64-channel modules)	1024 channels (8-, 16-, 32- or 64-channel modules)
	Analog I/O	24 channels (4-, 8- or 16- channel modules)	80 channels (4-, 8- or 16- channel modules)
	Integrated process control	–	Configurable loops (10 channels with 3 loops max.)
<b>In-rack application-specific channels</b>	Max. no. of channels	8	24
	Counter	Modules with 2/4 counter channels 1 MHz max., single-channel electronic cam module	
	Motion (2)	Modules with 1/2 axes for stepper motors, 2/3/4 axes for analog control servo motors, 8/16 axes with SERCOS™ digital link	
	Weighing	Module for 8 load cells (2 application-specific channels)	
<b>Serial link connections</b>	Modbus®	In-rack communication modules (1 application-specific channel)	
	Uni-Telway™	RS 232, RS 485 or current loop (3) (4) master/slave PCMCIA modules and RS 485 master/slave in-rack communication modules	
	Character mode	1 integrated RS 485 master/slave channel, RS 232, RS 485 or current loop (3) (4) master/slave PCMCIA modules and RS 485 master/slave in-rack communication modules	
<b>Bus connections</b>	Actuator/sensor bus AS-Interface® master V2	1 integrated RS 485 channel, RS 232, RS 485 or current loop (3) (4) PCMCIA modules and RS 485 in-rack communication modules	
	CANopen machine bus master V4.02 (5)	2 in-rack modules	4 in-rack modules
	INTERBUS® fieldbus master V2 (5) or Profibus DP™ fieldbus master V0 Class 1 and 2 (5)	1 PCMCIA module (3)	1 in-rack module
<b>Network connections</b>	Max. no. of networks	–	1
	Ethernet	1	
	Network modules	Multiprotocol in-rack modules (Modbus®/TCP, Uni-TE™, Global Data, I/O Scanning, TCP Open), Web server, FactoryCast™ service and FactoryCast HMI services	
<b>Memory capacity</b>	Without PCMCIA extension	Fipway® (3) (4) and Modbus Plus (3) PCMCIA modules, Ethway™ in-rack modules	
	With PCMCIA extension	32 Kwords program and data	48/64 Kwords program and data (6)
	Data storage	32 Kwords data	48/64 Kwords data (6)
	Symbol storage	64 Kwords program	160 Kwords program
		128 Kwords	640 Kwords + 2048 Kwords
<b>Power supply</b>		–	128 Kwords
		100...240 V ~, 24 V = non-isolated and 24...48 V = isolated power supply modules. A power supply is required for each rack.	
<b>Premium processor</b>	Standard	<b>TSX™ P57 103M</b>	<b>TSX P57 203M ↗</b>
	Integrated Ethernet		<b>TSX P57 2623M ↗ (8)</b>
	Integrated Fipio®	<b>TSX P57 153M (7)</b>	<b>TSX P57 253M ↗</b>
	Integrated Ethernet and Fipio		<b>TSX P57 2823M (8)</b>
<b>Pages</b>		1/31	

(1) The maximum values for the numbers of discrete I/O, analog I/O and process control channels are cumulative.  
 (2) 1 axis = 1 application-specific channel, except for SERCOS modules where, depending on the configuration, the module = 2...32 channels.  
 (3) Module to be inserted into the lower PCMCIA slot (no. 1) on the processor.  
 (4) Module to be inserted into the PCMCIA slot on the TSX SCY 21 601 in-rack communication module.  
 (5) Reduce the number of INTERBUS or Profibus DP modules permitted by 1 when CANopen is used.  
 (6) The second value corresponds to the processor with integrated Fipio bus manager link.



**TSX™ 57 3● processors**

**TSX 57 4● processors**



16 with 4, 6, or 8 slots or 8 with 12 slots			
1024 channels (8-, 16-, 32- or 64-channel modules)			
128 channels (4-, 8- or 16- channel modules)			
Configurable loops (15 channels with 3 loops max.)			
32	64		
Modules with 2/4 counter channels 1 MHz max., single-channel electronic cam module			
Modules with 1/2 axes for stepper motors, 2/3/4 axes for analog control servo motors, 8/16 axes with SERCOS digital link			
Module for 8 load cells (2 application-specific channels)			
In-rack communication modules (1 application-specific channel)			
RS 232, RS 485 or current loop (3) (4) master/slave PCMCIA modules and RS 485 master/slave in-rack communication modules			
1 integrated RS 485 master/slave channel, RS 232, RS 485 or current loop (3) (4) master/slave PCMCIA modules and RS 485 master/slave in-rack communication modules			
1 integrated RS 485 channel, RS 232, RS 485 or current loop (3) (4) PCMCIA modules and RS 485 in-rack communication modules			
8 in-rack modules			
1 PCMCIA module (3)			
2 in-rack modules			
3	4		
Multiprotocol in-rack modules (Modbus®/TCP, Uni-TE™, Global Data, I/O Scanning, TCP Open), Web server, FactoryCast™ service and FactoryCast HMI services			
Fipway® (3) (4) and Modbus Plus™ (3) PCMCIA modules, Ethway in-rack modules			
64/80 Kwords program and data (6)	96 Kwords program and data		
80/96 Kwords data (6)	176 Kwords data		
384 Kwords program	512 Kwords program (992 Kwords with PL7 V4.4 or higher)		
640 Kwords + 2048 Kwords	2048 Kwords (640 Kwords + 2048 Kwords with PL7 V4.4 or higher)		
128 Kwords	256 Kwords (384 Kwords with PL7 V4.4 or higher)		
100...240 V ~, 24 V --- non-isolated and 24...48 V --- isolated power supply modules. A power supply is required for each rack.			
	TSX P57 303AM ↗		
	TSX P57 3623AM ↗ (8)		
TSX™ P57 353LAM (9)	TSX P57 353AM ↗	TSX P57 453AM	
			TSX P57 4823AM (8)
1/31			

(7) The TSX P57 153M processor does not support the CANopen bus PCMCIA module.

(8) The integrated Ethernet port requires one of the available network connections.

(9) Processor reserved for updating configuration with TSX P57 352M PL7 processor (old version)

↗ Processor can be migrated from PL7 to Unity Pro by means of a simple update of the processor's operating system (included on the Unity Pro software CD-ROM).

ⓘ New feature

# Modicon® Premium™ automation platform PL7™ processors

## Presentation

Premium™ **TSX™ P57 ●●3M/3AM** and **TSX P57 ●●23M/23AM** automation platform processors manage the entire PLC station, and are comprised of discrete I/O modules, Preventa™ machine safety modules, analog I/O modules, and application-specific modules, that can be distributed over one or more racks connected via Bus X or a fieldbus.

## TSX P57 processors

The types of processor available are divided into different capacities according to memory, in-rack I/O, communication, and processing speed. According to the model:

- 4 to 16 racks
- 512 to 2040 discrete I/O
- 24 to 256 analog I/O
- 8 to 64 application-specific channels: Each application-specific module (counter, motion control, serial link or weighing) accounts for 1 or a number of application-specific channels.
- 1 to 4 networks (Ethernet, Fipway®, Ethway™, Modbus Plus™), 2 to 8 AS-Interface® sensor/actuator buses, 1 to 2 fieldbuses (CANopen, INTERBUS®, Profibus DP™), 0 or 1 Fipio fieldbus, serial links (Modbus®, Uni-Telway™)
- 10 to 20 process control channels

## Integrated communication

According to the model, Premium processors include:

- A 10 or 100 Mbit/s Ethernet Modbus/TCP port (RJ45 connection)
- A 1 Mbit/s Fipio bus link (bus manager)
- Communication via 2 terminal ports (TER and AUX) using Uni-Telway or character mode protocol (typically a 19 or 115 Kbit/s programming terminal and an operator dialog terminal)

Each processor has a slot for a type III PCMCIA card that can accommodate a network card (Fipway, Modbus Plus), bus (CANopen (1), Fipio Agent) or serial links (Modbus, Uni-Telway, character mode).

## Application design and installation

Different software licences are available for PL7™ Junior/Pro version V4.5 depending on requirements:

- Single-station
- Multistation in the form of independent local stations (Junior/Pro), remote stations connected to a server via a network (Pro Open Team for 3 to 10 stations or Pro OpenSite for more than 10 stations).

These licences are compatible with PC terminals running Windows 2000 Professional® or Windows XP® operating systems.

## Configurations with TSX P57 351/352M processor

The **TSX P57 353LAM** single-format processor is intended as a replacement for the old version **TSX P57 351M/352M** processors.

## Migration of Modicon® Premium™ processors

Some Premium **TSX P57 ●●3M/3AM** processors that are compatible with PL7 software can be migrated for compatibility with the Unity Pro™ software without the need for hardware modifications. This migration from PL7 to Unity Pro is achieved by means of the following software updates:

- Processor operating system
- Integrated Ethernet port operating system

This update is carried out using the OS-Loader tool, included in Unity Pro (see page 6/27). Once migrated, PL7 processors are equivalent to corresponding Unity processors.

The following PL7 processors can be migrated to Unity Pro (software migration):

- TSX 57 2●: **TSX P57 203/253/2623M** become **TSX P57 204/254/2634M** respectively.
- TSX 57 3●: **TSX P57 303/353/3623AM** become **TSX P7 304/354/3634M** respectively (migration supported by Unity Pro version ≥ 3.0).

*Note: Processor migration requires the use of new PCMCIA TSX MRP P/C, TSX MFP P/C memory references. See the equivalence table on page 1/32.*

(1) Not with **TSX P57 153M** processor.

### Presentation (continued)

#### Migration of Modicon® Premium™ processors (continued)

Migration offers involving the replacement of the processor are available for other product references. Please contact your Regional Schneider Electric Sales Office for more information about these offers. They are only available for a limited period of time, and include the following PL7™ processors:

- **TSX™ P57 2823M** for migration to **TSX P57 254M** with **TSX ETY 4103 (1)**
- **TSX P57 453AM** for migration to **TSX P57 454M**
- **TSX P57 453AM** for migration to **TSX P57 554M**
- **TSX P57 4823AM** for migration to **TSX P57 4634M**
- **TSX P57 4823AM** for migration to **TSX P57 5634M**
- **TSX P57 4823AM** for migration to **TSX P57 454M** with **TSX ETY 4103 (1)**
- **TSX P57 4823AM** for migration to **TSX P57 554M** with **TSX ETY 4103 (1)**

### Description

#### Processors without integrated Ethernet port

Single-format **TSX P57 1●3M/353LAM** processors and double-format **TSX P57 2●3M/3●3AM/453AM** processors feature the following on the front panel:

- 1 A display block with 5 LEDs:
  - RUN LED (green): Processor in operation (program running)
  - ERR LED (red): Controller detected fault on the processor or its on-board devices (PCMCIA memory card and PCMCIA communication card)
  - I/O LED (red): Controller detected fault occurring on another station module or configuration fault
  - TER LED (yellow): Activity on the terminal port
  - FIP LED (red): Activity on the integrated Fipio bus
- 2 RESET button causing a cold restart of the PLC when it is activated
- 3 An 8-way female mini-DIN connector marked TER for connecting a programming or adjustment terminal
- 4 An 8-way female mini-DIN connector marked AUX for connecting a peripheral device
- 5 A PCMCIA slot (no. 0) for a memory extension card
- 6 A PCMCIA slot (no. 1) for a communication card or 4 Mb SRAM memory extension card for storing additional data
- 7 A 9-way SUB-D connector (on TSX P57 153/253M, TSX P57 353 LAM and TSX P57 353/453AM models) for Fipio bus manager communication

#### Processors with integrated Ethernet port

Double-format **TSX P57 2623/2823M** and **TSX P57 3623AM/4823AM** processors with integrated Ethernet port feature the following on the front panel:

- 1 A display block with 5 LEDs:
  - RUN LED (green): Processor in operation (program running)
  - ERR LED (red): Controller detected fault on the processor or its on-board devices (PCMCIA memory card and PCMCIA communication card)
  - I/O LED (red): Controller detected fault occurring on another station module or configuration fault
  - TER LED (yellow): Activity on the terminal port
  - FIP LED (red): Activity on the integrated Fipio bus
- 2 A display block relating to the integrated Ethernet port featuring 5 LEDs:
  - RUN LED (green): Ethernet port ready
  - ERR LED (red): Ethernet port inoperative
  - COL LED (red): Collision detection
  - STS LED (yellow): Ethernet link diagnostics
  - Two TX and RX LEDs (yellow): Transmission/reception activity
- 3 RESET button causing a cold restart of the PLC when it is activated
- 4 An 8-way female mini-DIN connector marked TER for connecting a programming or adjustment terminal
- 5 An 8-way female mini-DIN connector marked AUX for connecting a peripheral device
- 6 An RJ45 connector for connection to the Ethernet network
- 7 A PCMCIA slot (no. 0) for a memory extension card
- 8 A PCMCIA slot (no. 1) for a communication card or 4 Mb SRAM memory extension card for storing additional data
- 9 A 9-way SUB-D connector (on TSX P57 2823M/4823AM models) for Fipio bus manager communication

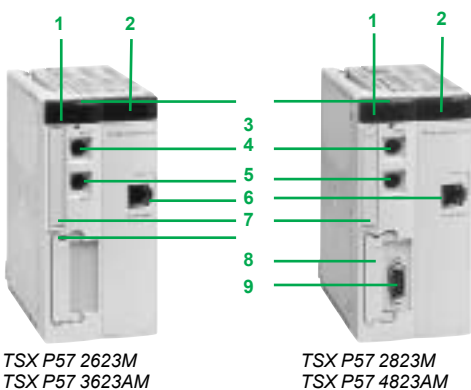
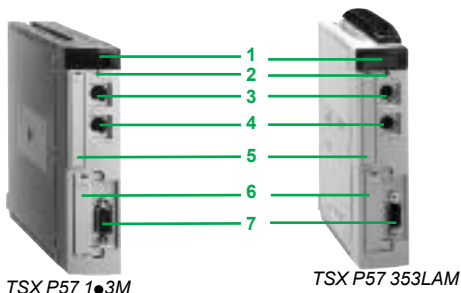

(1) The **TSX ETY 4103** Ethernet Modbus/TCP module offered features the same functions as the integrated Ethernet port on **TSX P57 2823M/4823AM** processors. However, the combined processor and Ethernet module use one slot more than the PL7 processor to be migrated. Therefore, this type of migration requires a free slot in the Premium rack and modification of the converted Unity Pro application.

Modicon® Premium™ PLCs have been developed to comply with major national and international standards on electronic industrial automation equipment. See pages 9/8 to 9/19 “Standards, certification and environmental conditions”.

## Characteristics and performance

Types of processor			TSX P57 103M	TSX P57 153M	TSX P57 203M	TSX P57 2623M	TSX P57 253M	TSX P57 2823M	
<b>Maximum configuration</b>	No. of racks	4/6/8 slots	4		16				
		12 slots	2		8				
		Max. no. of slots for modules	32		128				
<b>Functions</b>	Max. no in-rack (1)	Discrete I/O	512		1024				
		Analog I/O	24		80				
		Process control channels	–		10 (up to 30 simple loops)				
		Application-specific channels, number	8		24				
		Application-specific channels, type	Counter, axis, weighing and serial links (Modbus®, Uni-Telway™ and asynchronous)						
	Integrated connections	Ethernet	–			1		–	
		Fipio® manager	–			1 (63 agents)		–	
		Serial link	1 link with 2 connectors (TER and AUX) 19.2 Kbit/s						
	Max. no. of connections	Networks (Ethernet, Fipway®, Modbus Plus™, Ethway™)	1		1		1 integrated Ethernet port		1
		AS-Interface® bus	2		4				
CANopen bus		1		–		1		1 integrated Ethernet port	
INTERBUS® or Profibus DP™ bus		–		1, none if CANopen is used					
<b>Memories</b>	Maximum capacity	Without PCMCIA card	<b>Keywords</b>	32, program and data		48, program and data		64, program and data	
		With PCMCIA card	<b>Keywords</b>	64, program 32, data		160, program 48, data		160, program 64, data	
		Data storage	<b>Keywords</b>	128		2688			
	Maximum size of object zones	Located internal bits (%Mi)	<b>bits</b>	4096		8132			
		Located internal data	<b>Keywords</b>	30.5 for internal words %M <i>oi</i> 32 for constant words %K <i>oi</i>					
<b>Application structure</b>	Tasks	Master	1		1				
		Fast	1		1				
		Event	32 (1 has priority)		64 (1 has priority)				
<b>Execution time per instruction</b>	Without PCMCIA card	Boolean	<b>µs</b>	0.50		0.19			
		On word or fixed-point arithmetic	<b>µs</b>	0.62		0.25			
		On floating points	<b>µs</b>	44		2.6			
	With PCMCIA card	Boolean	<b>µs</b>	0.60		0.21			
		On word or fixed-point arithmetic	<b>µs</b>	0.87		0.42			
		On floating points	<b>µs</b>	44		2.6			
<b>No. of Kinstructions executed every ms</b>	Without PCMCIA card	100% Boolean	<b>Kinst/ms</b>	1.52		4.76			
		65% Boolean and 35% fixed arithmetic	<b>Kinst/ms</b>	1.05		3.57			
	With PCMCIA card	100% Boolean	<b>Kinst/ms</b>	1.18		3.70			
		65% Boolean and 35% fixed arithmetic	<b>Kinst/ms</b>	0.85		2.50			
<b>System overhead</b>	Tasks	Master	<b>ms</b>	1.50		3.10		1.00	
		Fast	<b>ms</b>	0.80		0.35		1.2	

(1) Only affects in-rack modules. The maximum values for the number of discrete I/O, analog I/O, application-specific channels, and process control channels are cumulative. The remote I/O on the bus or network (CANopen, AS-Interface, Uni-Telway, Fipio, Modbus Plus, etc.) or fieldbus (INTERBUS or Profibus DP) are not included in these maximum numbers.

Modicon® Premium™ PLCs have been developed to comply with major national and international standards on electronic industrial automation equipment. See pages 9/8 to 9/19 “Standards, certification and environmental conditions”.

Characteristics and performance (continued)				TSX™ P57 303AM	TSX P57 3623AM	TSX P57 353LAM P57 353AM	TSX P57 453AM	TSX P57 4823AM	
<b>Types of processor</b>									
<b>Maximum configuration</b>	No. of racks	4/6/8 slots		16					
		12 slots		8					
		Max. no. of slots for modules		128					
<b>Functions</b>	Max. no in-rack (1)	Discrete I/O		1024			2040		
		Analog I/O		128			256		
		Process control channels		15 (up to 45 simple loops)			20 (up to 60 simple loops)		
		Application-specific channels, number		32			64		
		Application-specific channels, type		Counter, axis, weighing and serial links (Modbus®, Uni-Telway™ and asynchronous)					
	Integrated connections	Ethernet		–	1	–	–	1	
		Fipio® manager		–	–	1 (127 agents)		–	
		Serial link		1 link with 2 connectors (TER and AUX) 19.2 or 115 Kbit/s					
	Max. no. of connections	Networks (Ethernet, Fipway®, Modbus Plus™, Ethway™)		3	3 including integrated Ethernet port	3	4	4 including integrated Ethernet port	
		AS-Interface® bus		8					
CANopen bus			1						
INTERBUS® or Profibus DP™ bus			2, 1 if CANopen is used						
<b>Memories</b>	Maximum capacity	Without PCMCIA card	<b>Keywords</b>	64, program and data		80, program and data	96, program and data		
		With PCMCIA card	<b>Keywords</b>	384, program 80, data		384, program 96, data	512/992 (2), program 176, data		
		Data storage	<b>Keywords</b>	640 + 2048				2048/640 + 2048 (2)	
	Maximum size of object zones	Located internal bits (%Mi)	<b>bits</b>	16,384			32,768		
		Located internal data	<b>Keywords</b>	30.5 for internal words %M <i>oi</i> 32 for constant words %K <i>oi</i>					
<b>Application structure</b>	Task	Master		1					
		Fast		1					
		Event		64 (1 has priority)					
<b>Execution time per instruction</b>	Without PCMCIA card	Boolean	□s	0.12		0.19/0.12 (3)		0.06	
		On word or fixed-point arithmetic	□s	0.17		0.25/0.17 (3)		0.08	
		On floating points	□s	2.5		2.6/2.5 (3)		1.7	
	With PCMCIA card	Boolean	□s	0.17		0.21/0.17 (3)		0.06	
		On word or fixed-point arithmetic	□s	0.33		0.42/0.33 (3)		0.08	
		On floating points	□s	2.6		2.6/2.6 (3)		1.7	
<b>No. of instructions executed every ms</b>	Without PCMCIA card	100% Boolean	<b>Kinst/ms</b>	6.57		4.76/6.57 (3)		13.82	
		65% Boolean and 35% fixed arithmetic	<b>Kinst/ms</b>	4.70		3.57/4.70 (3)		8.80	
	With PCMCIA card	100% Boolean	<b>Kinst/ms</b>	4.49		3.70/4.49 (3)		13.82	
		65% Boolean and 35% fixed arithmetic	<b>Kinst/ms</b>	3.08		2.50/3.08 (3)		8.80	
<b>System overhead</b>	Tasks	Master	<b>ms</b>	1.15		1.00/1.15 (3)		1.15	
		Fast	<b>ms</b>	0.29		0.35/0.29 (3)		0.22	

(1) Only affects in-rack modules. The maximum values for the number of discrete I/O, analog I/O, application-specific channels, and process control channels are cumulative. The remote I/O on the bus or network (CANopen, AS-Interface, Uni-Telway, Fipio, Modbus Plus, etc.) or fieldbus (INTERBUS or Profibus DP) are not included in these maximum numbers.

(2) The second value applies if PL7 Junior/Pro programming software V4.4 or higher is used.

(3) The first value applies to the single-format TSX P57 353LAM processor and the second to the double-format TSX P57 353AM processor.

1

Processor without PCMCIA card

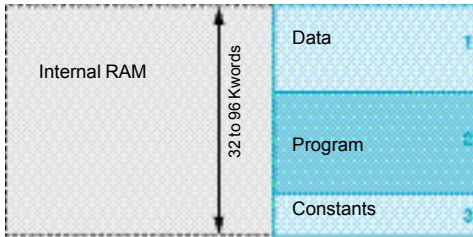

- 1 Application data (30.5 Kwords max.)
- 2 Task descriptor and executable code
- 3 Constant words, initial values and configuration

Processor with PCMCIA card

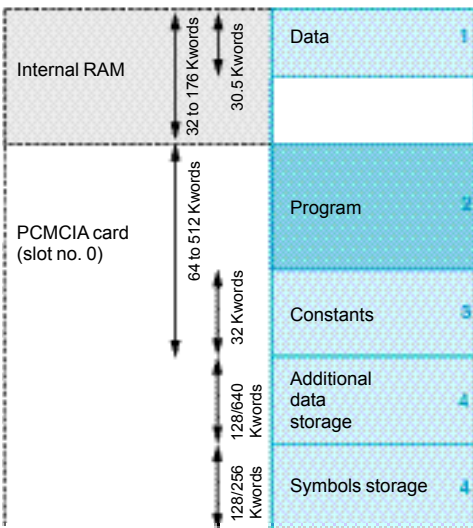

- 1 Application data (30.5 Kwords max.)
- 2 Task descriptor and executable code
- 3 Constant words, initial values and configuration
- 4 Depending on the model of PCMCIA card

## Memory structure

The application memory is divided into memory areas that are physically distributed across the internal RAM memory and the PCMCIA memory extension card(s):

- The application data area is always in the internal RAM.
- The application program area is in the internal RAM or the PCMCIA memory card.
- The constants area is in the internal RAM or the PCMCIA memory card.

There are two ways of organizing the application memory for **TSX™ P57 1●3/2●3/2●23M** and **TSX P57 3●3/3623/453/4823AM** processors with or without a memory extension installed in the form of a PCMCIA format card:

### Application in internal RAM

The application is completely loaded into the processor's battery-backed internal RAM (1). The capacity depends on the processor model (32 to 96 Kwords).

For example, the **TSX P57 1●3M** processor has 7.5 Kwords of application data and 24.5 Kwords of program, constants and system data (2).

The memory space (32 Kwords) is shared between the application data, the program, the constants and the system data (2).

### Application in the PCMCIA card (slot no. 0)

The internal RAM is reserved for the application data.

The PCMCIA card contains the program and constants (64 to 512 Kwords).

The file storage area of 128 K or 640 Kwords (depending on the model of PCMCIA card) can be used in remote applications, for storing production data information, recipes, etc.

The symbols storage area of 128 K or 256 Kwords (depending on the model of PCMCIA card) enables the application symbols database to be stored on the PLC.

### Extension of the additional data storage area (slot no. 1)

This area, containing 128 or 640 Kwords, can be extended up to 2688 Kwords by using an SRAM **TSX MRP DS 2048P/MFP 004M** PCMCIA memory card. This card is inserted into the lower slot on **TSX P57 2●3/2●23M**, **TSX P57 3●3/3623/453/4823AM** processors and can be used in conjunction with memory extension cards (type 1 in the upper slot).

### Data in internal RAM

The data area can be extended to up to 30.5 Kwords. It is only supported by the PLC's internal RAM.

PL7™ Junior/Pro software helps the application designer to manage the structure and organize how the memory space on the Premium PLC is occupied.

## Protecting the application

Regardless of the PLC memory structure (whether the application is located in the internal RAM or on the PCMCIA card), it is possible to protect the application so that it cannot be accessed (for the purpose of reading or modifying the program) in online mode under PL7 Junior/Pro.

A memory protection bit, set in configuration mode, is also available to prevent any program modification (via the programming terminal or downloading).

## Modicon® Premium™ processor references

TSX 57 10/20/30/40 processors are equipped with:

- A PCMCIA slot (no. 0) that can accommodate a memory extension or SRAM memory card for the purpose of storing additional data
- A PCMCIA slot (no. 1) that can accommodate a communication card or memory card for the purpose of storing additional data
- Two terminal ports (8-way female mini-DIN type), Uni-Telway or character mode.

TSX 57 processors are double-format modules (except **TSX P57 1●3M** and **TSX P57 353LAM** processors, which are single-format).

TSX 57 30/40 processors support the loading of programs, via the terminal port, at a maximum speed of 115 Kbit/s (limited to 19.2 Kbit/s for TSX 57 10/20 processors).

The integrated Fipio® link (bus manager) on TSX 57 20/30/40 processors supports a maximum of 127 connection points. The link on the **TSX P57 153M** processor is limited to 63 connection points.

(1) The internal RAM is protected by an optional battery with a life of 3 years. The battery is located in the power supply module.

(2) The system has a minimum reserve RAM memory area in the order of 5 Kwords. Please refer to the PL7 Micro/Junior/Pro reference manual.



TSX P57 103M TSX P57 153M

### TSX™ 57 processors

I/O capacity (1)	Capacity		Maximum number of bus/network modules	Integrated Port	Reference	Weight kg
	Memory	Control channels				
<b>TSX 57 10 4 racks (2)</b>						
512 discrete I/O 24 analog I/O 8 application-specific channels	32 Kwords	0	1 network	–	TSX P57 103M	0.380
	integrated 64 Kwords max. on PCMCIA		2 AS-Interface® buses 1 CANopen bus			
			1 integrated Fipio® 1 network	–	TSX P57 153M	0.420
			2 AS-Interface buses			



TSX P57 203M TSX P57 353LAM

### TSX 57 20 16 racks (2)

1024 discrete I/O 80 analog I/O 24 application-specific channels	48 Kwords integrated	10	1 network	–	TSX P57 203M	0.520
	160 Kwords max. on PCMCIA		4 AS-Interface buses 1 CANopen bus (3) 1 fieldbus (3)			
			4 AS-Interface buses 1 CANopen bus (3) 1 fieldbus (3)	1 Ethernet	TSX P57 2623M	–
	64 Kwords integrated. 160 Kwords max. on PCMCIA	10	1 integrated Fipio 1 network	–	TSX P57 253M	0.560
			4 AS-Interface buses 1 CANopen bus (3) 1 fieldbus (3)			
			1 integrated Fipio 4 AS-Interface buses 1 CANopen bus (3) 1 fieldbus (3)	1 Ethernet	TSX P57 2823M	–

TSX P57 253M  
TSX P57 353AM  
TSX P57 453AM

### TSX 57 30 16 racks (2)

1024 discrete I/O 128 analog I/O 32 application-specific channels	64/80 Kwords integrated (4)	15	3 networks	–	TSX P57 303AM	0.520
	384 Kwords max. on PCMCIA		8 AS-Interface buses 1 CANopen bus (3) 2 fieldbuses (3)			
			2 networks 8 AS-Interface buses 1 CANopen bus (3) 2 fieldbuses (3)	1 Ethernet	TSX P57 3623AM	–
	80/96 Kwords integrated (4)	15	1 integrated Fipio 3 networks	–	TSX P57 353LAM (5)	0.420
	384 Kwords max. on PCMCIA		8 AS-Interface buses 1 CANopen bus (3) 2 fieldbuses (3)		TSX P57 353AM (5)	0.560

TSX P57 2623M  
TSXP57 3623AM

### TSX 57 40 16 racks (2)

2040 discrete I/O 256 analog I/O 64 application-specific channels	96/176 Kwords integrated (4)	20	1 integrated Fipio	–	TSX P57 453AM	0.560
	12/992 Kwords max. (6) on PCMCIA		4 networks (7) 8 AS-Interface buses 1 CANopen bus (3) 2 fieldbuses (3)			
			1 CANopen bus (3) 2 fieldbuses (3)	1 Ethernet	TSX P57 4823AM	–

TSX P57 2823M  
TSX P57 4823AM

### PCMCIA memory extension cards

Premium processors can support up to 2 memory extension cards. However, useful memory capacity is limited to the maximum size defined for the processor model.

**References**, see pages 1/32 and 1/33.

- (1) Cumulative maximum values. The number of remote I/O on the bus is not included.
- (2) Maximum number of TSX™ RKY 4EX/6EX/8EX racks (4, 6 or 8 slots). Using the TSX™ RKY 12EX rack (12 slots) is the same as using 2 racks with 4, 6 or 8 slots.
- (3) Using the CANopen bus reduces the number of possible fieldbuses (INTERBUS®/Profibus DP™) by 1.
- (4) The second value corresponds to the integrated memory capacity when the processor is equipped with a PCMCIA memory card.
- (5) Single-format processor for TSX™ P57 353LAM, double-format processor for TSX P57 353AM.
- (6) 992 Kwords with PL7 Junior/Pro software V4.4 or higher.
- (7) 3 networks with TSX P57 4823AM processor.

# Modicon® Premium™ automation platform

## PCMCIA memory extension cards

### PL7™

1



PCMCIA Flash EPROM memory



PCMCIA SRAM memory

### Presentation

PCMCIA memory extension cards are used to extend the internal RAM capacity of Premium processors. Depending on the model, these cards are designed to:

- Receive the application program and constants
- Store additional application data and/or various application object symbols

### Offer for Modicon® Premium™ platform under PL7™

As of November 2004, the old **TSX™ MRP/MFP ●●●P** PCMCIA memory extension cards offer, which was specifically for Premium processors under PL7, was replaced by a new offer. This offer includes (1):

- TSX Micro™ PLCs under PL7
- Premium processors under Unity™ Pro and PL7
- Modicon® Quantum™ processors under Unity Pro

The table below indicates equivalences between the old and new versions. There may be one or more new references corresponding to each old reference depending on whether migration from PL7 to Unity Pro is envisaged.

SRAM memory extension (slot no. 0)								
Use	Max. memory size			Old reference	Do you envisage migration from PL7 to Unity Pro? (P indicates "PL7 program")		Recommended reference	
	PL7 application	Additional data	Symbol storage					
All TSX 57 types	32 Kwords	–	–	TSX MRP 032P	No	Yes	TSX MRP P128K	
		128 Kwords	–	TSX MRP 232P	No	Yes	TSX MRP P384K	
	64 Kwords	–	–	TSX MRP 064P	No	Yes, P < 52 Kwords	TSX MRP P224K	
			128 Kwords	–	–	Yes, P > 52 Kwords	TSX MRP P384K	
TSX 57 20 TSX 57 30 TSX 57 40			128 Kwords	–	–	Yes (2)	TSX MRP P384K	
			128 Kwords	–	–	Yes (2)	TSX MRP P384K	
			128 Kwords	128 Kwords	TSX MRP 2128P	No	Yes (2)	TSX MRP C768K
			128 Kwords	–	–	Yes (2)	TSX MRP C01M7	
			256 Kwords	–	–	Yes, P < 104 Kwords	TSX MRP C768K	
			256 Kwords	–	–	Yes, 128 Kwords < P < 208 Kwords	TSX MRP C001M	
			256 Kwords	–	–	Yes, P > 208 Kwords	TSX MRP C01M7	
			640 Kwords	128 Kwords	TSX MRP 3256P	No	Yes	TSX MRP C01M7
			640 Kwords	–	–	Yes (3)	TSX MRP C002M	
			640 Kwords	–	–	Yes (4)	TSX MRP C003M	
TSX 57 40			384 Kwords	640 Kwords	–	Yes (2)	TSX MRP C01M7	
			384 Kwords	640 Kwords	–	Yes (2)	TSX MRP C01M7	
			512 Kwords	–	–	Yes (2)	TSX MRP C002M	
			512 Kwords	–	–	Yes, P < 256 Kwords	TSX MRP C01M7	
TSX 57 40			512 Kwords	–	–	Yes, 256 Kwords < P < 384 Kwords	TSX MRP C002M	
			512 Kwords	–	–	Yes, P > 384 Kwords	TSX MRP C003M	
			992 Kwords	640 Kwords	384 Kwords	–	–	TSX MRP C007M

Flash EPROM memory extension (slot no. 0)								
Use	Max. memory size			Old reference	Do you envisage migration from PL7 to Unity Pro? (P indicates "PL7 program")		Recommended reference	
	PL7 application	Additional data	Symbol storage					
All TSX 57 types	32 Kwords	–	–	TSX MFP 032P	No	Yes	TSX MFP P128K (5)	
		128 Kwords	–	TSX MFP 232P	No	Yes	TSX MCP C224K (5)	
	64 Kwords	–	–	TSX MFP 064P	No	No	TSX MFP 064P2 (1)	
					No	Yes, P < 52 Kwords	TSX MFP P224K (5)	
TSX 57 20 TSX 57 30 TSX 57 40			128 Kwords	–	–	Yes, P > 52 Kwords	TSX MFP P384K (5)	
			128 Kwords	–	–	Yes	TSX MCP C224K (5)	
			128 Kwords	–	–	No	TSX MFP 0128P2 (1)	
			256 Kwords	–	–	No	Yes	TSX MFP P384K (5)
			256 Kwords	–	–	No	Yes	TSX MFP P001M (5)

SRAM memory extension (slot no. 1)							
Use	PL7 application	Additional data	Symbol storage	Old reference	Do you envisage migration from PL7 to Unity Pro? (P indicates "PL7 program")	Recommended reference	
TSX 57 20 TSX 57 30 TSX 57 40	–	2048 Kwords	–	TSX MRP DS 2048P	No	Yes	TSX MRP F004M

Flash EPROM backup card (slot no. 0)							
Use	PL7 application	Additional data	Symbol storage	Old reference	Do you envisage migration from PL7 to Unity Pro? (P indicates "PL7 program")	Recommended reference	
TSX 57 10	32 Kwords	–	–	TSX MFP BAK 032P	No	Yes	TSX MFP B096K (4)

(1) With the exception of **TSX MFP 064P2/0128P2** Flash EPROM memory cards for use with PL7 processors.  
 (2) Selection based on the size of the PL7 program memory in relation to the size of the data storage memory.  
 (3) If symbols do not need to be stored on the PCMCIA.  
 (4) If additional data does not need to be stored on the PCMCIA.  
 (5) Memory card compatible with processor version ≥ 5.5.



### Presentation (continued)

#### PCMCIA memory extension cards

Memory cards (with the exception of **TSX™ MRP P004M** and **TSX MRP DS 2048P** for additional SRAM data storage) are inserted into PCMCIA slot no. 0 on Modicon® Premium™ processors (upper slot). The **TSX™ MRP F004M/TSX MRP DS 2048P** additional data storage card is inserted into slot no. 1 only on Premium processors (lower slot).

With PL7™, these cards support four different types of storage:

- Application storage: Program and constants in a common area of between 64 and 512 Kwords, in the SRAM or Flash EPROM memory.
- Application and additional data storage, comprising an application area of between 64 and 384 Kwords and a data storage area of 128 or 640 Kwords designed for additional data, in the SRAM or Flash EPROM and SRAM.
- Application, additional data and symbol storage, comprising an application area of between 32 and 512 Kwords, a data storage area of 128 or 640 Kwords designed for additional data, and a symbols area of 128 or 256 Kwords, in the SRAM or Flash EPROM and SRAM.
- Additional data storage provided by an SRAM with a capacity of 2 M words.

These cards use 2 technologies:

- Battery-backed SRAM. Used in particular in the creation and debugging phases for the application program. These cards support application transfer and modification services in online mode and the storage of additional data. The memory is backed up by a removable battery integrated into the PCMCIA card. A second, auxiliary battery, provides backup so that the main battery can be replaced without data being lost.
- Flash EPROM. Used once debugging of the application program is complete. It enables restrictions in terms of the service life of backup batteries to be avoided and supports global application transfer. If a Flash EPROM is used, the application cannot be modified in online mode.

### References

If future migration from PL7™ to Unity™ Pro is envisaged, see the equivalence table opposite for the new equivalent reference.

#### SRAM memory extension (slot no. 0)

Use	Max. memory size			Old reference	Reference	Weight kg
	PL7 application	Additional data	Symbol storage			
TSX™ 57 10...40	32 Kwords	–	–	TSX MRP 032P	TSX™ MRP P128K	0.076
	64 Kwords	–	–	TSX MRP 064P	TSX MRP P224K	0.076
		128 Kwords	–	TSX MRP 232P/264P	TSX MRP P384K	0.076
TSX 57 20...40	128 Kwords	–	–	TSX MRP 0128P	TSX MRP C448K	0.076
		128 Kwords	128 Kwords	TSX MRP 2128P	TSX MRP C768K	0.076
	256 Kwords	–	–	TSX MRP 0256P	TSX MRP C001M	0.076
		640 Kwords	128 Kwords	TSX MRP 3256P	TSX MRP C01M7	0.076
TSX 57 40	384 Kwords	640 Kwords	–	TSX MRP 3384P	TSX MRP C002M	0.076
	512 Kwords	–	256 Kwords	TSX MRP 0512P	TSX MRP C003M	0.076
	992 Kwords	640 Kwords	384 Kwords	–	TSX MRP C007M	0.076

#### Flash EPROM memory extension (slot no. 0)

TSX 57 10...40	32 Kwords	–	–	TSX MFP 032P	TSX™ MFP P128K (1)	0.044
	64 Kwords	–	–	TSX MFP 064P	TSX MFP P224K (1)	0.044
		–	–	TSX MFP 064P	TSX MFP 064P2 (2)	0.044
		128 Kwords	–	TSX MFP 232P/264P	TSX MCP C224K (1)	0.044
TSX 57 20...40	128 Kwords	–	–	TSX MFP 0128P	TSX MFP P384K (1)	0.044
		–	–	TSX MFP 0128P	TSX MFP 0128P2 (2)	0.044
	256 Kwords	–	–	–	TSX MFP P001M (1)	0.044

#### Flash SRAM memory extension (slot no. 1)

TSX 57 20...40	–	2048 Kwords	–	TSX MRP DS 2048P	TSX MRP F004M	0.076
----------------	---	-------------	---	------------------	---------------	-------

#### Flash EPROM backup card (slot no. 0)

TSX 57 10	32 Kwords	–	–	TSX MFP BAK 032P	TSX MFP B096K (1)	0.044
-----------	-----------	---	---	------------------	-------------------	-------

#### Replacement parts

Description	Use	Type	Reference	Weight kg
Backup batteries	PCMCIA SRAM memory cards	Main battery	TSX™ BAT M02 (3)	0.010
		Auxiliary battery	TSX BAT M03 (4)	0.05
Handle	Removal of PCMCIA memory card (provided with the memory card)	–	TSX™ P CAP	0.010

(1) Memory card (blue) compatible with processor version ≥ 5.5.

(2) Memory card (orange) only compatible in run mode (no backup facility) with processor version ≤ 5.0 and < 6.1 compatible with processor version ≥ 6.1. Memory card designed for PL7 processors.

(3) For the SRAM memory card with the old reference **TSX MRP ●●●P** or with the new reference **PV < 04** (green), quote order reference number **TSX BAT M01**.

(4) Only for SRAM memory cards with a new reference.



# Racks, I/O architectures and power supplies



---

## 2.1 - Power supply and fan modules

- Description . . . . . 2/2
- Characteristics . . . . . 2/3
- Functions . . . . . 2/4
- References . . . . . 2/5
- Dimensions and mounting . . . . . 2/5

## 2.2 - Single rack configuration

- Presentation,description . . . . . 2/6
- References . . . . . 2/6
- Dimensions and mounting . . . . . 2/7

## 2.3 - Multi-racks configuration without remote module

- Presentation . . . . . 2/8
- Description . . . . . 2/9
- Rack addresses . . . . . 2/9
- References . . . . . 2/10
- Dimensions and mounting . . . . . 2/11

## 2.4 - Multi-racks configuration with remote module

- Presentation . . . . . 2/12
- Description . . . . . 2/13
- References . . . . . 2/13

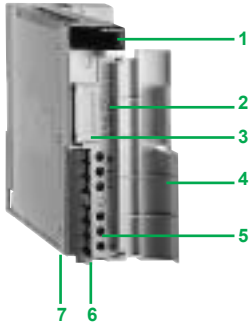

TSX PSY 2600M

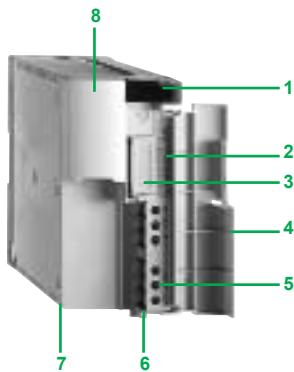

TSX PSY 5500M



### Description of power supply modules

**TSX™ PSY●●●0M** power supply modules provide the power supply for each rack and the modules installed on it.

The power supply module is selected according to:

- The mains electrical supply:  $\sim 24\text{ V}$ ,  $\sim 24\dots48\text{ V}$ ,  $\sim 100\dots120$ ,  $\sim 200\dots240\text{ V}$
- The required power: standard format or double format model, see power consumption table on page 9/6.

**TSX PSY●●●0M** power supply modules are comprised of:

- 1 Display block comprising:
  - OK lamp (green), on if voltages are present and correct.
  - BAT lamp (red), on if the battery is inoperative or missing.
  - 24 V lamp (green), on when the sensor voltage is present (according to model).
- 2 RESET pencil-point pushbutton causing a warm restart of the application.
- 3 Slot for a battery that protects the internal RAM memory of the processor.
- 4 Cover to protect the front panel of the module.
- 5 Screw terminal for connecting:
  - To mains supply.
  - The alarm relay contact.
  - The sensor power supply for a.c. supplies (according to model).
- 6 Opening for cable clamp.
- 7 Fuse located beneath the module and protecting:
  - 24 VR voltage on the non-isolated d.c. supply with **TSX PSY 3610**.
  - Primary voltage on the other power supplies.
- 8 110/220 voltage selector (according to model).

### Description of fan modules

**TSX™ FAN ●●P** fan modules installed above the racks of Modicon® Premium™ PLCs provide forced air convection, in order to maintain an even ambient temperature inside the enclosure and to eliminate the various hot spots that may exist.

Fan modules are required whenever the ambient temperature is between 60 °C and 70 °C (forced ventilation enables the ambient temperature in the enclosure to be lowered by 10 °C) (1).

Three types of fan module are available:  $\sim 24\text{ V}$ ,  $\sim 110\text{ V}$  and  $\sim 220\text{ V}$ .

According to the modularity of the racks used:

- One fan module for a 4 or 6 position rack,
- Two fan modules for an 8 position rack,
- Three fan modules for a 12 position rack.

**TSX FAN ●●P** fan modules are comprised of:

- 1 Connection terminal for the fan module power supply, the internal temperature probe and the associated LED or preactuator.
- 2 Ground terminal.
- 3 Two mounting holes for the fan module.
- 4 Shuttered air outlets.

(1) For an ambient temperature between 25 °C and 60 °C, the use of fan modules increases the MTBF.

Characteristics				TSX PSY 1610M	TSX PSY 3610M	TSX PSY 5520M	
<b>Type of power supply module</b>							
<b>Primary</b>	Voltage	Nominal	V	~ 24	~ 24	~ 24...48	
		Limit (ripple included)	V	~ 19.2...30 (1) (possible up to 34 V for 1 h in evry 24 h)		~ 19.2...60	
	Frequency	Nominal/limit	Hz	–	–	–	
	Current	Nominal input	A rms	≤ 1.5 at ~ 24 V	≤ 2.7 at ~ 24 V	≤ 3 at ~ 24 V ≤ 1.5 at ~ 48 V	
		Initial start up at 25 °C (2)	1 inrush	A	100 at ~ 24 V	150 at ~ 24 V	15 at ~ 24 V 15 at ~ 48 V
		I <sup>2</sup> t on activation		A²s	12.5	20	50 at ~ 24 V 55 at ~ 48 V
			It on activation	As	0.2	0.5	7 at ~ 24 V 6 at ~ 48 V
	Duration of micro breaks	Main supply (accepted)		ms	≤ 1	≤ 1	≤ 1
			Integrated protection		By fuse 5 x 20, time-delayed 3.5 A	No	By fuse 5 x 20, time-delayed 5 A
	<b>Secondary</b>	Power	Total useful (typical)	W	30	50	50
Output ~ 5 V			Nominal voltage	V	5	5	5
Output ~ 24 VR (3)		Nominal current	A	3	7	7	
		Power (typical)	W	15	35	35	
		Nominal voltage	V	U mains - 0.6	U mains - 0.6	24	
		Nominal current		A	0.6	0.6	0.8
			Power (typical)	W	15	19	19
Output ~ 24 V sensors					–	–	
Integrated protection on outputs (4)				Yes, against overloads, short-circuits and overvoltages			
<b>Conformity to standards</b>				IEC 61131-2			
<b>Isolation</b>	Dielectric withstand	Primary/secondary and primary/ground	V eff	Non isolated, internal 0 V connected to PLC ground		2000 - 50/60 Hz - 1 min	
		Insulation resistance	M□	–		≥ 10	
<b>Type of power supply module</b>							
<b>Primary</b>	Voltage	Nominal	V	~ 100...240	~ 100...120/200...240	~ 85...140/170...264	
		Limit (ripple included)	V	~ 85...264	~ 85...140/190...264	~ 85...140/170...264	
	Frequency	Nominal/limit	Hz	50...60/47...63			
	Current	Nominal input	A rms	0.5 at ~ 100 V 0.3 at ~ 240 V	1.7 at ~ 100 V 0.5 at ~ 240 V	1.7 at ~ 100 V 0.5 at ~ 240 V	
		Initial start up at 25 °C (2)	1 inrush current	A	37 at ~ 100 V 75 at ~ 240 V	38 at ~ 100 V 38 at ~ 240 V	30 at ~ 100 V 60 at ~ 240 V
		I <sup>2</sup> t on activation		A²s	0.63 at ~ 100 V 2.6 at ~ 240 V	4 at ~ 100 V 2 at ~ 240 V	15 at ~ 100 V 8 at ~ 240 V
			It on activation	As	0.034 at ~ 100 V 0.067 at ~ 240 V	0.11 at ~ 100 V 0.11 at ~ 240 V	0.15 at ~ 100 V 0.15 at ~ 240 V
	Duration of micro breaks	Mains supply (accepted)		ms	≤ 10	≤ 10	≤ 10
			Integrated protection		By fuse 5 x 20, time-delayed, 4 A		
	<b>Secondary</b>	Power	Total useful (typical)	W	26	50	77 (5)
Output ~ 5 V			Nominal voltage	V	5	5	5
Output ~ 24 VR (3)		Nominal current	A	5	7	15	
		Power (typical)	W	25	35	75	
		Nominal voltage	V	24	24	–	
		Nominal current		A	0.6	0.8	–
			Power (typical)	W	15	19	–
Output ~ 24 VC		Sensors	A	0.5	0.8	1.6 (TBTS)	
Integrated protection on outputs (4)				Yes, against overloads, short-circuits and overvoltages			
<b>Conformity to standards</b>				IEC 61131-2			
<b>Isolation</b>	Dielectric withstand	Primary/secondary and primary/ground	V eff	2000 - 50/60 Hz - 1 min		3000 - 50/60 Hz - 1 min	
		Insulation resistance	M□	≥ 100			

(1) When supplying modules with relay outputs, the range is reduced to 21.6...26.4 V.  
 (2) These values should be taken into account when starting several devices simultaneously and for sizing protection devices.  
 (3) Output ~ 24 V for supplying relays of modules with relay outputs.  
 (4) Output ~ 24 VR, cannot be accessed by the user and is protected by a fuse located beneath the module (5 x 20, 4 A, type Medium)  
 (5) 77 W at 60 °C, 85 W at 55 °C, or 100 W at 55 °C using TSX FAN●●P fan modules.

### Functions

#### Alarm relay

The alarm relay located in each power supply module has a volt-free contact that can be accessed on the connection screw terminal of the module.

The operating principle is as follows:

- Module alarm relay located on the processor rack (rack 0): in normal operation, PLC in RUN, the alarm relay is activated and its contact is closed (state 1). Whenever the application stops, even partially:

- occurrence of a blocking condition
- incorrect output voltages
- loss of mains power,

the relay de-energizes and the associated contact opens (state 0).

- Alarm relay of power supply modules located on other racks (racks 1 to 7): when the module is powered up and if the output voltages are correct, the relay is activated and its contact is closed (state 1). When the mains power is lost or if the output voltages are incorrect, the relay de-energizes (state 0).

#### Back-up battery

Each power supply module has a slot reserved for a battery that provides the power supply to the internal RAM memory located in the processors, in order to help ensure that data is saved when the PLC is switched off. The duration of data back-up is one year. The battery must be changed as soon as the BAT lamp (red) on the front panel lights up.

#### RESET pushbutton

Pressing this pushbutton, on the front panel of the power supply module, triggers a sequence of service signals that is the same for:

- A power break when the pushbutton is pressed
- A power up when the pushbutton is released

These operations are expressed by the application as a warm restart.

#### Sensor power supply $\approx$ 24 V

The TSX™ PSY 2600M/5500M/8500M a.c. power supply modules have an integrated power supply that provides a voltage of  $\approx$  24 V to supply the input sensors. Connection to this sensor power supply can be accessed via the module screw terminal. The available power on  $\approx$  24 V depends on model (0,5/0,8/1,6 A), see characteristics page 2/3.



TSX PSY 2600M



TSX PSY 5500M



TSX FAN ●●P

## References

Each TSX™ RKY ●/●EX rack must be equipped with a single or double format power supply module (slot marked PS).  
The power required to supply each TSX RKY rack depends on the type and number of modules installed in the rack. It is therefore necessary to establish a power consumption table rack by rack in order to determine the TSX PSY power supply module most suitable for each rack (see pages 9/6 and 9/7).

### Power supply module

Power supply	Available power (1)			Format	Reference (2)	Weight kg
	⎓ 5 V	⎓ 24 VR	⎓ 24 VC Total			
⎓ 24 V non isolated (3)	15 W	15 W	–	Standard	<b>TSX PSY 1610M</b>	0.540
	35 W	19 W	–	Double	<b>TSX PSY 3610M</b>	0.780
⎓ 24...48 V isolated	35 W	19 W	–	Double	<b>TSX PSY 5520M</b>	0.890
~ 100...240 V 25 W	15 W	12 W	26 W	Standard	<b>TSX PSY 2600M</b>	0.510
~ 100...120 V 35 W	19 W	19 W	50 W	Double	<b>TSX PSY 5500M</b>	0.620
~ 200...240 V 75 W	–	38 W (SELV)	77 W	Double	<b>TSX PSY 8500M</b>	0.740

### Accessories

Description	Use	Quantity	Reference	Weight kg
Battery	Internal RAM memory backup (position in power supply modules)	1 battery	<b>TSX PLP 01</b>	0.010
		10 batteries	<b>TSX PLP 101</b>	0.100

### Fan modules

Description	Use	Power supply	Reference	Weight kg
Fan modules (4)	For TSX RKY ● or TSX RKY ●EX racks	⎓ 24 V	<b>TSX™ FAN D2P</b>	0.500
		~ 100...120 V	<b>TSX FAN A4P</b>	0.500
		~ 200...240 V	<b>TSX FAN A5P</b>	0.500

(1) Voltages ⎓ 5 V and ⎓ 24 VR for power supply to Premium modules, voltage ⎓ 24 VC for supplying power to input sensors. The sum of absorbed power on each voltage (⎓ 5 V, ⎓ 24 VR and ⎓ 24 VC) should not exceed the total power of the module. See power consumption table on page 9/6.

(2) Product supplied with a processor RAM memory backup battery.

(3) The internal 0 V of the module is connected to the PLC ground.

(4) One fan module for rack with 4 or 6 positions, two fan modules for rack with 8 positions and three fan modules for rack with 12 positions. Product supplied with bilingual Quick Reference Guide: English and French.

## Dimensions/mounting TSX FAN ●P

Side view

Front view

Fan module mounting

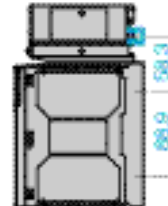
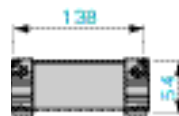
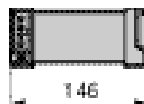

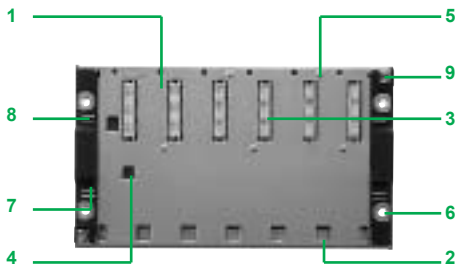
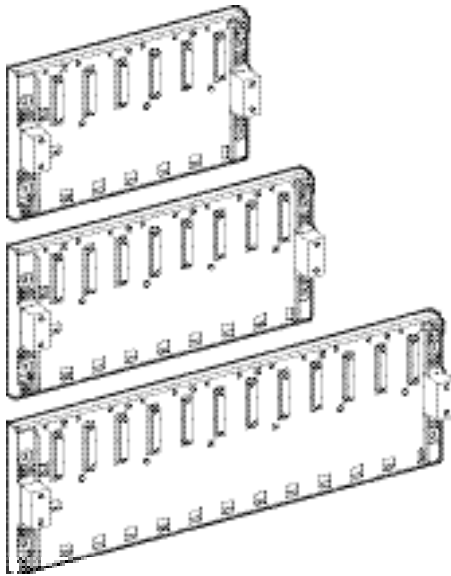

TSX RKY 6

### Presentation

**TSX™ RKY ●●** racks form the basic elements of the Premium control system platform with a single rack (6, 8 or 12 positions).

These non extendable racks provide the following functions:

- Mechanical function: they enable the modules of a PLC station (power supply, processor, discrete I/O, analog I/O, application-specific modules) to be fitted.
- Electrical function: they enable connection to the bus (bus X) and provide distribution of: They enable connection to:
  - power supplies required for each module in the same rack,
  - data and service signals for the entire PLC station where this has several racks.

**TSX™ FAN ●●P** fan modules installed above the racks of Premium PLCs provide forced air convection, in order to maintain an even ambient temperature inside the enclosure and to eliminate the various hot spots that may exist (see page 2/2).

### Description

**TSX RKY ●●** non-extendable racks are comprised of:

- 1 Metal frame.
- 2 Slots for anchoring the module pins.
- 3 48-way female 1/2 DIN connectors for module-rack connections (the first connector is reserved for the power supply module).
- 4 Locating slot for the power supply module.
- 5 Tapped holes for fixing the module.
- 6 Four holes for mounting the rack.
- 7 Position for rack address label.
- 8 Position for station network address label.
- 9 Two ground terminals for grounding the rack.

### References

#### Non-extendable racks

Description	Type of modules to be installed	Capacity	Reference	Weight kg
Non-extendable racks, for single rack configuration	TSX PSY power supply,	6 positions	<b>TSX RKY 6 (1)</b>	1.470
	TSX P57 processor,	8 positions	<b>TSX RKY 8 (1)</b>	1.750
	TSX H57 processor I/O modules, application-specific modules	12 positions	<b>TSX RKY 12</b>	2.310

#### Connection accessories

Description	Use	Comprising	Unit reference	Weight kg
<b>Protective covers</b>	Unoccupied position on TSX RKY ●● or TSX RKY ●EX racks	5 screw-on covers (Sold in lots of 5)	<b>TSX™ RKA 02</b>	0.050
<b>Mounting screws M6 x 25</b>	Mounting for TSX RKY ●● or TSX RKY ●EX racks	Captive screw and washer with hexagonal slotted head (Sold in lots of 50)	<b>TSX™ ACC VA625</b>	0.350

(1) In the case where the limits of electromagnetic emissions between 30 MHz and 1 GHz must be supervised, it is recommended to use the **TSX RKY 6EX/8EX** extendable racks instead of the **TSX RKY 6/8** non-extendable racks, see page 2/10.



## Dimensions, mounting

### TSX™ RKY

Common side view      Front view : TSX RKY 6 exemple

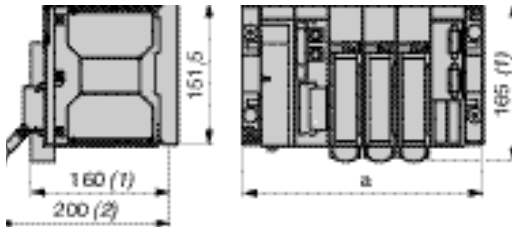

	a
TSX RKY 6	261.6
TSX RKY 8	335.3
TSX RKY 12	482.6

(1) With screw terminal block  
(2) With HE 10 or SUB-D type connectors

## Mounting of racks

on AM1 PA perforated plate

on AM1 ED profiles

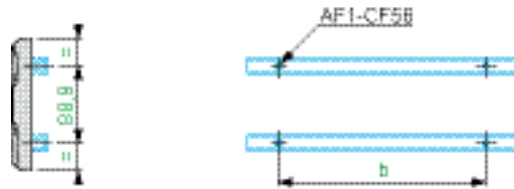
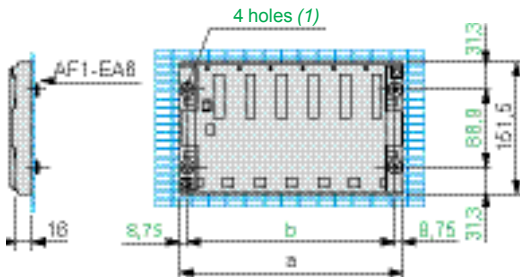

	a	b
TSX RKY 6	261.6	244.1
TSX RKY 8	335.3	317.8
TSX RKY 12	482.6	465.1

(1) For mounting on panel: the diameter of the holes must accommodate an M6 screw

## Installation rules

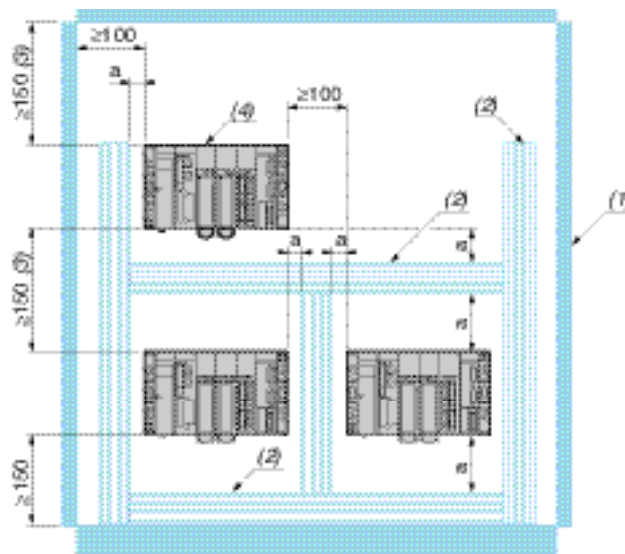

$a \geq 50 \text{ mm}$

- (1) Equipment or enclosure
- (2) Cable ducting or clip
- (3)  $\geq 130 \text{ mm}$  with TSX FAN ●●P fan module
- (4) TSX RKY 6: 1 fan module per rack  
TSX RKY 8: 2 fan modules per rack  
TSX RKY 12: 3 fan modules per rack

# Modicon® Premium™ automation platform

## Multi-racks configuration without remote module

2

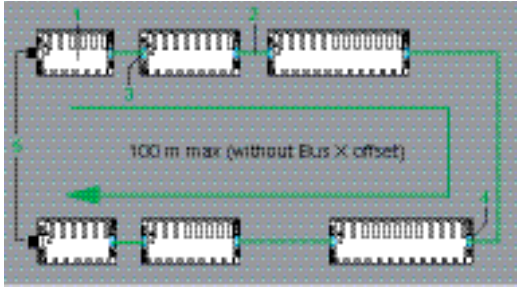

### Composition of a PLC station

Using 1 **TSX™ RKY 4EX/6EX/8EX/12EX** (1) extendable racks, a PLC station can be constituted which is comprised of up to:

- 4 racks for a station with TSX 57 10 Premium™ processor,
  - 16 racks for a station with TSX 57 20, 57 30, 57 40, 57 50 Premium™ processor.
- The racks are connected to each other by bus X extension cables 2.

### Bus X

The racks distributed on bus X are connected to each other via bus X extension cables whose total length is 100 m maximum. Using **TSX REY 200** bus X remote modules enables the length of bus X to be increased to a maximum of 2 x 350 m (see 2/12).

The racks are connected to each other using **TSX CBY ●●0K** bus X extension cables which are connected to one of the two 9-way SUB-D connectors on each extendable rack. The incoming cable from another rack can be connected to either the right 4 or left-hand 3 connector.

### Line terminations

The two extendable racks located at the ends of the line must have a **TSX TLY EX** line terminator 5 fitted on the unused 9-way SUB-D type connector.

### Presentation of extendable racks

**TSX RKY ●●EX** racks form the basic elements of the Modicon® Premium™ control system platform. These racks provide the following functions:

- Mechanical function: they enable the modules of a PLC station (power supply, processor, discrete I/O, analog I/O, application-specific modules) to be fitted.
- Electrical function: they enable connection to the bus (bus X) and provide distribution of:
  - power supplies required for each module in the same rack,
  - data and service signals for the entire PLC station where this has several racks.

To meet user requirements, several types of rack are available in order to make up PLC stations comprising 1 to 16 racks maximum distributed over bus X with a maximum cumulative length of 100 meters.

**TSX FAN ●●P** fan modules installed above the racks of Premium PLCs provide forced air convection, in order to maintain an even ambient temperature inside the enclosure and to eliminate the various hot spots that may exist (see page 2/2).

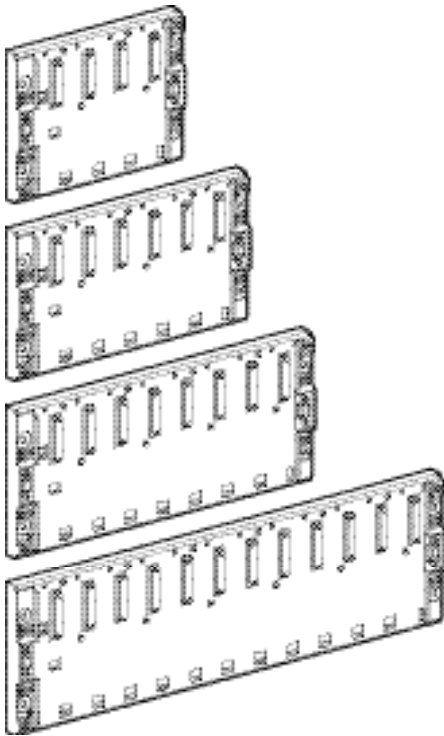

(1) Using the **TSX RKY 12EX** (12 slots) is the same as occupying 2 racks with 4, 6 or 8 slots.

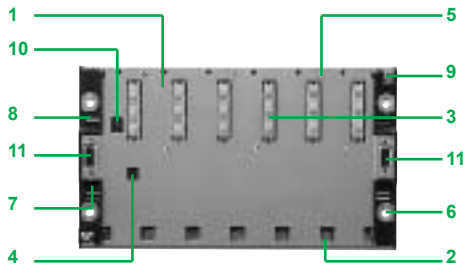

### Description

TSX™ RKY ●●● racks are comprised of:

- 1 Metal frame.
- 2 Slots for anchoring the module pins.
- 3 48-way female 1/2 DIN connectors for module-rack connections (the first connector is reserved for the power supply module).
- 4 Locating slot for the power supply module.
- 5 Tapped holes for Mounting the module.
- 6 Four holes for mounting the rack.
- 7 Position for rack address label.
- 8 Position for station network address label.
- 9 Two ground terminals for grounding the rack.
- 10 Microswitches for coding the rack address (on extendable racks).
- 11 Two 9-way female SUB-D connectors for the remote connection of bus X to another extendable rack.

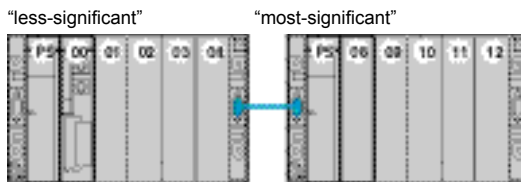

Address rack n, example with 2 racks 6 slots, standard format power supply and standard format processor

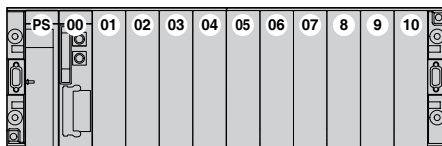

Address rack n, example with 1 rack 12 slots, standard format power supply and standard format processor



Principal rack address 0 with standard format power supply and standard format processor



Principal rack address 0 with double format power supply and standard format processor

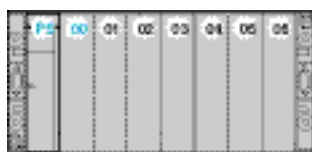

Extension rack address n with standard format power supply



Extension rack address n with double format power supply

### Rack addresses

Address 0: this address is always assigned to the rack which holds the processor. This rack can be located in any position on the line. Addresses 1 to 7: these can be assigned in any order to the other extendable racks of the station.

As the two racks with 4,6, or 8 slots which make up each pair can have the same address on the bus X, position numbers are defined as follows:

- Rack n "less-significant": position 00 to xx (02, 04 or 06); rack n "most-significant": position 08 to yy (10, 12 or 14).
- Each rack with 12 slots holds an address (with position 00 to 10).

### Installing the various modules on the standard or extendable rack with address 0

The rack with address 0 must contain a power supply module and the processor module. For Modicon® Premium™ PLCs which have two types of power supply (standard or double format), the position of the processor (standard or double format) will depend on the type of power supply used.

Using a standard format power supply module:

- The power supply module systematically occupies position PS.
- The processor module must be installed in position 00/01 (00 with standard format processor).
- The other modules are installed from position 02 (01 with standard format processor).

Using a double format power supply module:

- The power supply module systematically occupies positions PS and 00.
- The processor module must be installed in position 01/02 (01 with standard format processor).
- The other modules are installed from position 03 (02 with standard format processor).

### Installing the various modules on extendable racks with addresses 1 to 7

Each rack must have either a standard format or double format power supply module.

Using a standard format power supply module:

- The power supply module systematically occupies position PS.
- The other modules are installed from position 00 onwards.

Using a double format power supply module:

- The power supply module systematically occupies positions PS and 00.
- The other modules are installed from position 01 onwards.

# Modicon® Premium™ automation platform

## Multi-racks configuration without remote module

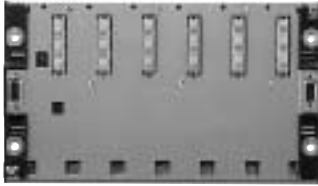

TSX RKY 6EX

2

### Extendable racks

Description	Type of modules to be installed	Capacity	Reference	Weight kg
<b>Extendable racks</b> for multi-racks configuration (max. 16 racks) (1)	TSX™ PSY power supply,	4 positions	<b>TSX™ RKY 4EX</b>	1.160
	TSX™ P57 or TSX H57 processor (main rack)	6 positions	<b>TSX RKY 6EX</b>	1.500
	I/O modules	8 positions	<b>TSX RKY 8EX</b>	1.780
	Application-specific modules Communication modules	12 positions	<b>TSX RKY 12EX</b>	2.340

### Connection accessories

Description	Use	Comprising	Length	Reference	Weight kg
<b>Daisy chaining cables</b> Bus X (total length 100 m max.) (2)	Between TSX RKY ●EX racks	2 x 9-way SUB-D connectors	1 m	<b>TSX™ CBY 010K</b>	0.160
			3 m	<b>TSX CBY 030K</b>	0.260
			5 m	<b>TSX CBY 050K</b>	0.360
			12 m	<b>TSX CBY 120K</b>	1.260
			18 m	<b>TSX CBY 180K</b>	1.860
			28 m	<b>TSX CBY 280K</b>	2.860
			38 m	<b>TSX CBY 380K</b>	3.860
			50 m	<b>TSX CBY 500K</b>	5.060
72 m	<b>TSX CBY 720K</b>	7.260			
100 m	<b>TSX CBY 1000K</b>	10.060			
<b>Cable on reel</b>	Length to be fitted with TSX CBY K9 connectors	Cable with free ends, 2 line testers	100 m	<b>TSX CBY 1000</b>	12.320
<b>Bus X connectors</b>	For TSX CBY 1000 cable ends	2 x 9-way SUB-D connectors	Sold in lots of 2	<b>TSX CBY K9</b>	0.080
<b>Line terminators</b>	Compulsory on the 2 TSX RKY ●EX end racks	2 x 9-way SUB-D connectors labelled A and B	Sold in lots of 2	<b>TSX™ TLY EX</b>	0.050
<b>Protective covers</b>	Unoccupied position on TSX RKY ● or TSX RKY ●EX racks	5 screw-on covers	Sold in lots of 5	<b>TSX™ RKA 02</b>	0.050
<b>Installation of connectors</b>	Mounting of TSX CBY K9 connectors	2 crimping pliers, 1 pen (3)	–	<b>TSX™ CBY ACC 10</b>	–
<b>Mounting screws M6 x 25</b>	Mounting for TSX RKY ● or TSX RKY ●EX racks	Captive screw and washer with hexagonal slotted head	Sold in lots of 50	<b>TSX™ ACC VA625</b>	0.350



TSX TLY EX

- (1) 16 racks **TSX RKY 4EX/6EX/8EX** max. (4, 6 or 8 slots) or 8 racks **TSX RKY 12EX** max. (12 slots). Using the **TSX RKY 12EX** (12 slots) is the same as occupying 2 racks with 4, 6 or 8 slots.  
 (2) 2 x 350 m maximum when using the **TSX REY 200** bus X remote module (see page 2/12).  
 (3) Installation of connectors on the cable also requires a wire stripper, a pair of scissors and a digital ohmmeter.

## Dimensions, mounting

### TSX™ RKY

Common side view      Front view : TSX RKY 6EX example



	a
TSX RKY 4EX	187.9
TSX RKY 6EX	261.6
TSX RKY 8EX	335.3
TSX RKY 12EX	482.6

(1) With screw terminal block  
(2) With HE 10 or SUB-D type connectors

### Mounting of racks

on AM1 PA perforated plate

On AM1 ED profiles

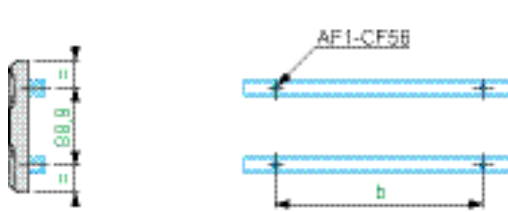
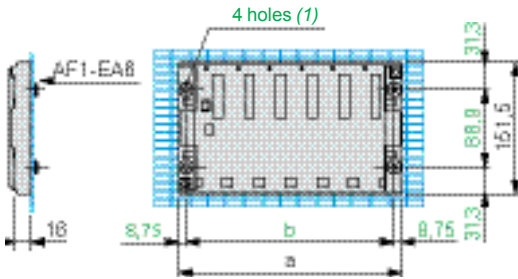

	a	b
TSX RKY 4EX	187.9	170.4
TSX RKY 6EX	261.6	244.1
TSX RKY 8EX	335.3	317.8
TSX RKY 12EX	482.6	465.1

(1) For mounting on panel: the diameter of the holes must accommodate an M6 screw

### Installation rules

$a \geq 50$  mm

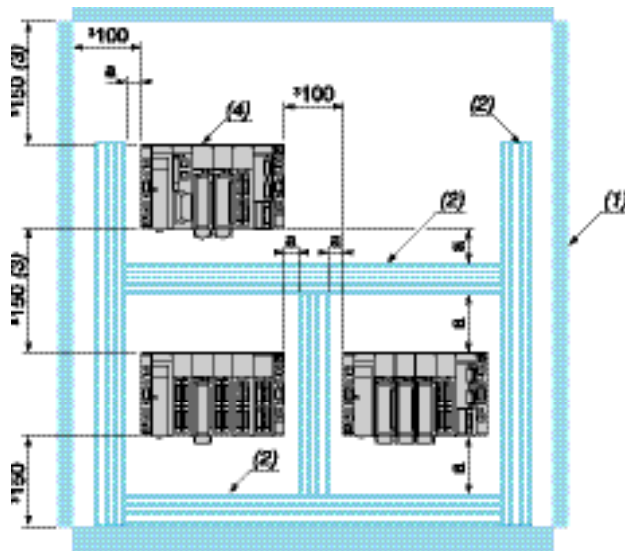

- (1) Equipment or enclosure
- (2) Cable ducting or clip
- (3)  $\geq 130$  mm with TSX FAN ●●P fan module
- (4) TSX RKY 4EX/6EX: 1 fan module per rack  
TSX RKY 8EX: 2 fan modules per rack  
TSX RKY 12EX: 3 fan modules per rack

# Modicon® Premium™ automation platform

## Multi-racks configuration with remote module

2

### Presentation

Bus X for Modicon® Premium™ PLCs can be used to connect eight 12 position racks or sixteen 4, 6 or 8 position racks, distributed over a maximum length of 100 meters (2/9).

For applications requiring longer distances between racks, the bus X remote rackmaster module: **TSX™ REY 200** can be used to increase this distance up to a maximum of 350 meters without reducing performance.

The bus X remote system is electrical. Using the bus X remote rackmaster module will not result in any loss of performance in reading or controlling I/O.

The bus X remote system is comprised of:

- One **TSX REY 200** module called the “master” **1** located on the rack at address 0 (rack supporting the processor **2** and the main bus X **3**). This module has 2 channels used to locate 2 bus X segments **5** remotely at a maximum distance of 250 meters.
- One or two **TSX REY 200** modules **4** called “slaves” located on each extendable rack.
- Each slave module is connected to the master module by a **TSX CBRY 2500** cable **5**, which the user should cut and fit with **TSX CBRY K5** connectors as required (cabling does not require any special equipment).

Each end of the bus should be fitted with a **TSX TLY EX** line terminator **6**.

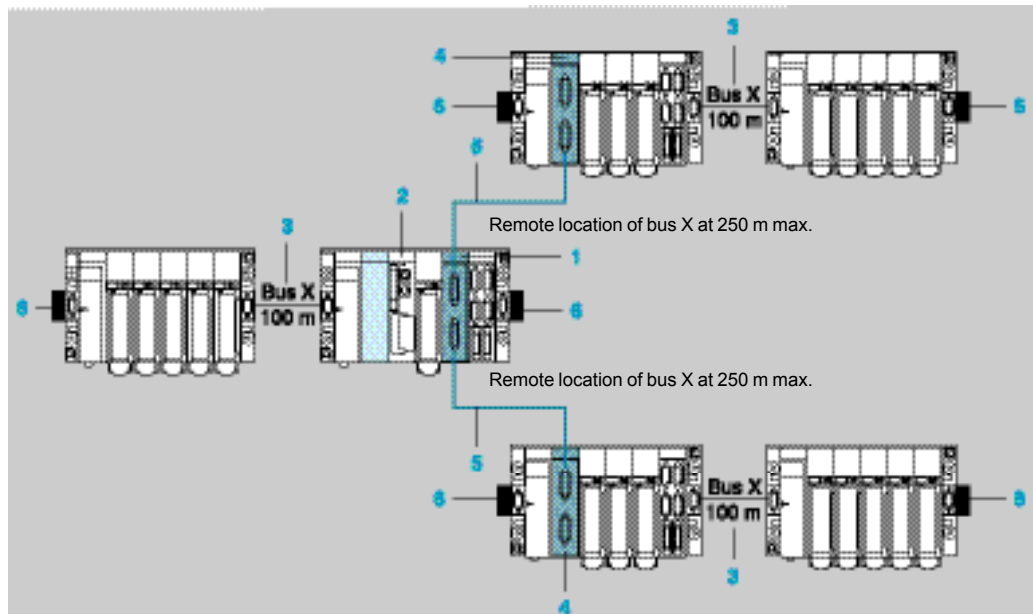

### Implantation rules

The rules for installing the bus X remote rackmaster module, **TSX REY 200**, are as follows :

- Bus X remote rackmaster module acting as a master. It is installed on the rack at address 0 supporting the processor with :
  - The power supply module systematically occupying position(s) PS (and 00). The processor module must be installed in position 01 (and 02 if it is a double format processor).
  - The bus X remote rackmaster module, **TSX REY 200**, can be installed in any position after 02 (or 03 if it is a double format processor).
- Bus X remote rackmaster module acting as a slave. It is installed in an extendable rack (located on an extendable bus X segment) in any position apart from the positions dedicated to the power supply module.

### Maximum distances for remote location

From one remote system, the maximum permitted distances from the processor are shown in the table below:

Type of modules	Reference	Length of bus X remote system 5
Discrete inputs (1)	TSX™ DEY ●●●	250 m
Discrete outputs	TSX™ DSY ●●●	
Preventa safety module	TSX™ PAY 262/282	
Discrete inputs/outputs (2)	TSX™ DMY	175 m less than the length 3 of bus X
Analog inputs/outputs (3)	TSX™ AEY ●●●/ASY ●●●	
Counting/motion modules (4)	TSX™ CTY ●A/CAY 21/CAY41/CFY ●1	
Weighing module	TSX™ ISP Y101/Y121	
AS-Interface bus module	TSX™ SAY 1000	Remote location of bus X not permitted
SERCOS motion modules	TSX™ CSY 84/85/164	
Communication modules	TSX™ SCY 21601/11601	
Ethernet TCP/IP modules	TSX™ ETY 110WS/4103/5103/WMY 100	
Fieldbus modules	TSX™ IBY 100/PBY100	
(1) Discrete inputs	TSX™ DEY 16FK (version ≥ 06)	
(2) Discrete inputs/outputs	TSX™ DMY 28FK/28RFK	
(3) Analog inputs/outputs	TSX™ AEY 810/1614	
	TSX™ ASY 410 (version ≥ 11)	
(4) Counting/motion modules	TSX™ CTY 2C/CCY 1128	
	TSX™ CAY 22/42/33	

### Description

The front panel of the bus X remote rackmaster module **TSX REY 200** is comprised of:

- 1 A display block with 6 indicator lamps:
  - RUN indicator: module running
  - ERR indicator: module has detected an internal fault
  - I/O indicator: module has detected an external fault
  - MST indicator: module acting as master or slave
  - CH0 indicator: channel 0 operating
  - CH1 indicator: channel 1 operating
- 2 5-way SUB-D 9 connector for the connection of channel 0.
- 3 5-way SUB-D 9 connector for the connection of channel 1.

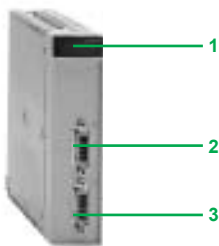

### References

Description Rep.	Operation	Number of channels	Reference	Weight kg
Extendable racks	–	4/6/8/12 positions	See page 2/10	
Bus X remote rackmaster module 1 or 4	Master/slave	2	TSX REY 200	–

### Connection cables and accessories

Description	Use	Length	Reference	Weight kg
Bus X cables supplied on a drum 5	Connection of two TSX REY 200 modules Class C1 flame resistance	250 m	TSX CBRY 2500	–
	Cable for daisy chain mounting (1)	250 m	TSX CBRY 2500F	–

5-ways SUB-D 9 connectors	Connections for bus X cable	Sold in lots of 5	TSX CBRY K5	–
---------------------------	-----------------------------	-------------------	-------------	---

Description	Use	Composition	Reference	Weight kg
Line terminators 6	Must be fitted on each TSX RKY ●EX end rack	2 x 9-way SUB-D connectors Sold in lots of 2	TSX TLY EX	0.050

(1) Mobile installations: cables as per VDE 472, part 603/H:  
 - for use on cable drag chain with minimum bend radius of 75 mm,  
 - for use on gantry crane (strikethrough: portal support), subject to compliance with conditions for use such as acceleration, speed, length etc: contact our regional branch office for further information.  
 - not authorized for use on robots, or multi-axis applications.



TSX REY 100



TSX TLY EX





## 3.1 - Discrete I/O modules

**Selection guide: Input and input/output modules** ..... 3/2

**Selection guide: output modules** ..... 3/4

- Discrete I/O modules

- Principle,description. .... 3/6

- Characteristics ..... 3/9

- References ..... 3/14

- Connections ..... 3/17

## 3.2 - Analog I/O modules

**Selection guide: Input and output modules** ..... 3/20

- Analog I/O modules

- Presentation,description ..... 3/22

- Functions ..... 3/23

- Characteristics ..... 3/24

- References ..... 3/26

## 3.3 - Distributed I/O systems

**Selection guide:IP 20 inputs/outputs** ..... 3/28

**Selection guide: Advantys™ IP 67 splitter boxes and interfaces** ..... 3/30

- Discrete I/O IP 67 modules on Fipio® bus ..... 3/32

## 3.4 - Specialized I/O

- TeSys® Quickfit for motor starter components

- Presentation. .... 3/42

- Compatibility with Modicon® automation platforms ..... 3/44



**Applications**

Connecting inputs to screw terminal blocks for bare wires fitted with either cable ends or open/closed cable tags

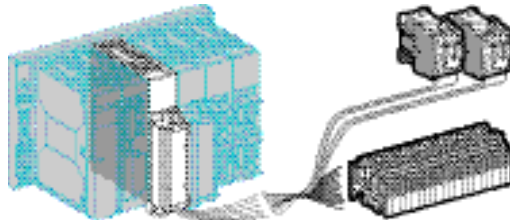

3

<b>Type</b>	
<b>Voltage</b>	
<b>Modularity</b> (Number of channels)	
<b>Connection</b>	
<b>Isolated inputs</b>	<b>IEC 61131-2 conformity</b>
	<b>Logic</b>
	<b>Sensor compatibility acc. to IEC 60947-5-2 standard</b>
<b>Isolated outputs</b>	<b>Fallback</b>
	<b>IEC 61131-2 conformity</b>
	<b>Protection</b>
	<b>Logic</b>
<b>Type of discrete input and I/O modules</b>	
<b>Pages</b>	
<b>Compatibility with installation system</b>	<b>Tego® Dial</b>
	<b>TeSys® Quickfit</b>
<b>Compatibility with Advantys™ Telefast® ABE 7 pre-wired system</b>	<b>Connection sub-bases</b>
	<b>Input adaptor sub-bases</b>
<b>Type of passive connection sub-bases</b>	<b>Miniature (55 or 72 mm)</b>
	<b>Standard (106 or 113 mm)</b>
	<b>Large width (194 mm)</b>
<b>Type of adaptor sub-base</b>	<b>Solid input relays</b>
	<b>Plug-in relays</b>
<b>Type of cordsets fitted with HE10 connectors</b>	

⋯	48 V	⋯ or ~	~
24 V	24 V	48 V	100...120V
8 isolated channels	16 isolated channels		
Via 20-way screw terminals: TSX BLY 01			
Type 2	–	Type 2	
Positive	Negative		–
2 wire ⋯/~, 3 wire PNP ⋯ any type	2 wire ⋯/~, 3 wire NPN ⋯ any type	2 wire ⋯/~	

<b>TSX™ DEY 08D2</b>	<b>TSX DEY 16D2</b>	<b>TSX DEY 16D3</b>	<b>TSX DEY 16A2</b>	<b>TSX DEY 16A3</b>	<b>TSX DEY 16A4</b>
3/14					
–					
–					
–					
–					
–					
–					
–					
–					
–					
–					

Connecting inputs to screw terminal blocks f

Connecting inputs to HE 10 connectors with preformed cables with flying leads, rolled ribbon cables or multicore cables

Connecting inputs to HE 10 connectors with preformed cables with flying leads, rolled ribbon cables or multicore cables

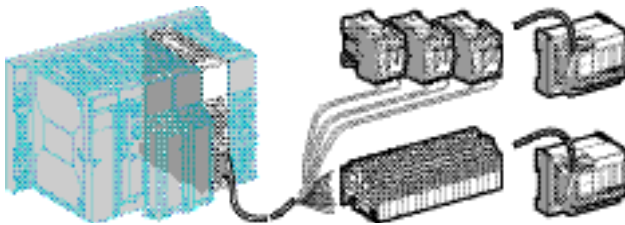

3

~	---						
200...240 V	24 V			48 V	24 V		
16 isolated channels	16 fast isolated channels	32 isolated channels	64 isolated channels	32 isolated channels	16 isolated inputs and 12 isolated outputs 0.5 A		
					Event-triggered fast inputs	Programmable reflex I/O	
Via 20-way screw terminals: TSX BLY 01	Via 20-way HE 10 connectors						
Type 2	Type 1				Type 1		
-	Positive						
2 wire ---/~	2 wire ---/~ , 3 wire PNP --- any type						

Output fallback may be configured, with continuous monitoring of output control and output reset in case of internal detected fault

Yes

Protected

Positive

<b>TSX™ DEY 16A5</b>	<b>TSX DEY16FK</b>	<b>TSX DEY 32D2K</b>	<b>TSX DEY 64D2K</b>	<b>TSX DEY 32D3K</b>	<b>TSX™ DMY 28FK</b>	<b>TSX DMY 28RFK</b>
3/14	Tego® Dialbase 8I/8O APE 1B24M				3/15	
-	Splitter box LU9 G02 (see page 3/44)				-	
-	8 or 16 channels, with or without LED, with common or 2 terminals per channel passive connection sub-bases				-	
-	16 channels --- 5 V TTL, --- 24 V, --- 48 V, ~ 115 V or 230 V, 2 terminals per channel adaptor sub-bases				-	
-	<b>ABE 7H08R●●, ABE 7H08S21, ABE 7H16R50, ABE 7H20E●●●</b>			-	<b>ABE 7H08R●●, ABE 7H08S21, ABE 7H16R50, ABE 7H20E●●●, ABE 7H12R50</b>	
-	<b>ABE 7H16S21, ABE 7H16R23, ABE 7H16R1●, ABE 7H16R2●, ABE 7H16R3●, ABE 7H16C●●</b>			<b>ABE 7H16R20</b>	<b>ABE 7H16R1●, ABE 7H16R2●, ABE 7H16R3●, ABE 7HC●●, ABE 7H16S21, ABE 7H16R23, ABE 7H12R●●</b>	
-	<b>ABE 7H16S43</b>			-	<b>ABE 7H16S43</b>	
-	<b>ABE 7S16E2●●</b>			-	-	
-	<b>ABE 7P16F3●●</b>			-	-	
-	<b>TSX CDP ●●3 or ABF H20●●0</b>			-	-	

**Applications**

Connecting outputs to screw terminal blocks for bare wires or wires fitted with either cable ends or open/closed cable tags (minimum cross-section 0.28 mm<sup>2</sup> maximum 1.5 mm<sup>2</sup>)

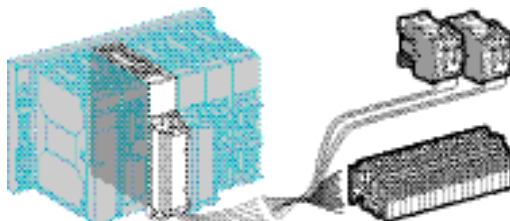

3

<b>Type</b>	
<b>Voltage</b>	
<b>Current</b>	
<b>Modularity</b> (number of channels)	
<b>Connection</b>	
<b>Isolated outputs</b>	<b>Fallback</b>
	<b>IEC 61131-2 conformity</b>
	<b>Protection</b>
	<b>Logic</b>
<b>Types of discrete output module</b>	
<b>Pages</b>	
<b>Compatibility with installation system</b>	<b>Tego® Dial</b>
	<b>TeSys® Quickfit</b>
<b>Compatibility with Advantys™ Telefast® ABE 7 pre-wired system</b>	<b>Connection sub-bases</b>
	<b>Input adaptor sub-bases</b>
<b>Type of passive connection sub-bases</b>	<b>Miniature (55 or 72 mm)</b>
	<b>Standard (106 or 113 mm)</b>
	<b>Large width (194 mm)</b>
<b>Type of adaptor sub-base</b>	<b>Solid input relays</b>
	<b>Plug-in relays</b>
<b>Type of cordsets fitted with HE10 connectors</b>	

--- transistor					--- our ~ relay	
24 V			48 V		--- 24 V, ~ 24...240 V	
0.5 A	2 A	0.5 A	1 A	0.25 A	3 A (lth)	
8 channels, protected		16 channels, protected	8 channels, protected	16 channels, protected	8 channels not protected	16 channels not protected
Via 20-way screw terminals: TSX BLY 01						
Output fallback may be configured, with continuous monitoring of output control and output reset in case of internal detected fault					Output fallback may be configured	
Yes						
Protected					Not protected	
Positive					-	
<b>TSX™ DSY 08T2</b>	<b>TSX DSY 08T22</b>	<b>TSX DSY 16T2</b>	<b>TSX DSY 08T31</b>	<b>TSX DSY 16T3</b>	<b>TSX DSY 08R5</b>	<b>TSX DSY 16R5</b>
3/15						
-						
-						
-						
-						
-						
-						
-						
-						
-						

Connecting outputs to screw terminal blocks for bare wires or wires fitted with either cable ends or open/closed cable tags (minimum cross-section 0.28 mm<sup>2</sup>, maximum 1.5 mm<sup>2</sup>)

Connecting outputs to HE 10 connectors with preformed cables with flying leads (cross-section 3.324 mm<sup>2</sup>), rolled ribbon cables (cross-section 0.08 mm<sup>2</sup>) or multicore cables (cross-section 0.324 mm<sup>2</sup>)

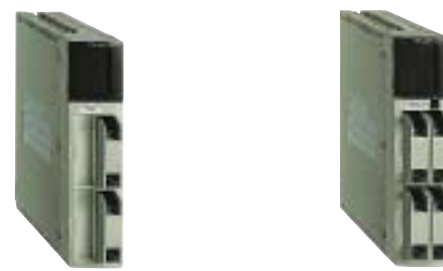
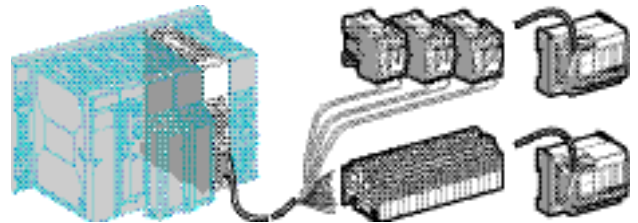

3

our ~ relay	relay	triac			transistor	
24...48 V ~ 24...240V	24...120 V	48...240 V		24...120 V		
5 A (lth)	5 A (lth)	2 A per channel	1 A per channel	1 A per channel		
8 channels, protected			16 channels, protected	16 channels, not protected		
Via 20-way screw terminals: TSX BLY 01			Via 20-way HE 10 connectors			
Output fallback may be configured			Output fallback may be configured, with continuous monitoring of output control and output reset in case of internal detected fault			
Yes						
Protected			Not protected			
-			Positive			
<b>TSX™ DSY 08R5A</b>	<b>TSX DSY 08R4D</b>	<b>TSX DSY 08S5</b>	<b>TSX DSY 16S5</b>	<b>TSX DSY 16S4</b>	<b>TSX DSY 32T2K</b>	<b>TSX DSY 64T2K</b>

3/15	
-	Tego® Dialbase 8I/8O APE 1B24M
-	Splitter box LU9 G02 (see page 3/44)
-	8 or 16 channels, with or without LED, with common or 2 terminals per channel
-	8 or 16 relay channels with 1 "NO", 1 or 2 "C/O" or transistor, 5...48 V, 24 V, ~ 24...240 V 1 or 2 terminals per channel
-	<b>ABE 7H08R●●, ABE 7H08S21</b>
-	<b>ABE 7H16S21</b>
-	<b>ABE 7H16F43</b>
-	<b>ABE 7S08S2●●, ABE 7R08S●●●, ABE 7S16S●●●, ABE 7R16S●●●</b>
-	<b>ABE 7P08T330, ABE 7R16T●●●, ABE 7P16T●●●</b>
-	<b>TSX CDP ●●3 or ABF H20●●0</b>

3

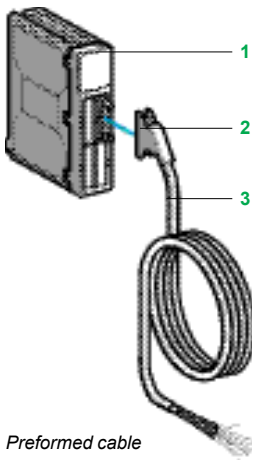

Preformed cable

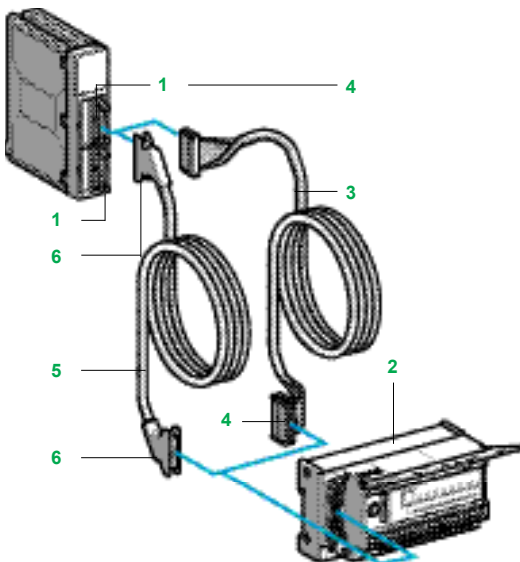

Rolled ribbon and connection cable

### Connecting modules with screw terminal blocks

Discrete I/O module terminal blocks have a device for automatically transferring the coding when first used. This prevents manipulation errors when a module is replaced. This coding helps to ensure electrical compatibility for the type of module.

Each terminal can accept bare wires or wire with cable ends with open tags.

The capacity of each terminal is:

- Minimum: 1 x 0.2 mm<sup>2</sup> wire (AWG 24) without cable end.
- Maximum: 1 x 2 mm<sup>2</sup> wire (AWG 14) without cable end or 1 x 1.5 mm<sup>2</sup> wire (AWG 15) with cable end.

Screw connection terminal blocks are equipped with captive screws.

The maximum terminal block capacity is 16 x 1 mm<sup>2</sup> (AWG 17) wires + 4 x 1.5 mm<sup>2</sup> (AWG 15) wires.

### Connecting modules with HE 10 connectors

#### Preformed cable with 20 wires, AWG 22-gauge (0.324 mm<sup>2</sup>)

Used for simple and direct wire to wire connection of the I/O of the module with connectors 1 to the sensors, preactuators or terminals.

This preformed cable 3 is comprised of:

- An insulated HE10 2 connector at one of the ends, with 20 x 0.34 mm<sup>2</sup> cross-section sheathed wires.
- At the other end 4, flying leads differentiated by a color code conforming to standard DIN 47100.

**TSX CDP 301:** 3 meters long,

**TSX CDP 501:** 5 meters long,

**TSX CDP 1001:** 10 meters long.

#### Rolled ribbon cable with sheath, AWG 28-gauge (0.08 mm<sup>2</sup>)

Used for connecting I/O of modules with HE 10 connectors 1 to Advantys™ Telefast® ABE 7 fast wiring 2 connection and adaptation interfaces.

This cable 3 has 2 HE 10 connectors 4 and a rolled ribbon cable with sheath with 0.08 mm<sup>2</sup> cross-section wires.

Given the small cross-section of the wires, it is recommended for use with low current I/O only (100 mA maximum per output).

**TSX CDP 102:** 1 meter long,

**TSX CDP 202:** 2 meters long,

**TSX CDP 302:** 3 meters long.

#### Connection cable, AWG 22-gauge (0.324 mm<sup>2</sup>)

Used for connecting the I/O of modules with HE 10 connectors 1 to Advantys Telefast ABE 7 fast wiring 2 connection and adaptation interfaces. This cable 5 has 2 insulated HE 10 connectors 6 and a cable for carrying higher currents (500 mA maximum).

**TSX CDP 053:** 0.5 meters long,

**TSX CDP 103:** 1 meter long,

**TSX CDP 203:** 2 meters long,

**TSX CDP 303:** 3 meters long,

**TSX CDP 503:** 5 meters long.

**TSX CDP 1003:** 10 meters long.

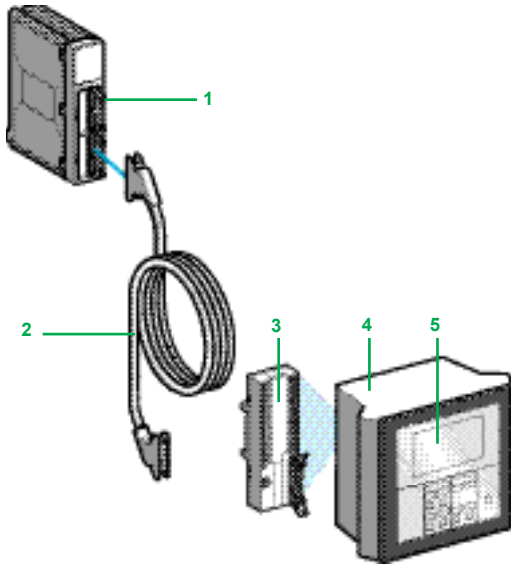

### Connection to Tego® Dial and TeSys® Quickfit systems

TSX™ DEY 16FK/32D2K/64D2K input modules and TSX™ DSY 32T2K/64T2K output modules 1 are specially designed for use in conjunction with Tego Dial and TeSys Quickfit systems (1).

The modules are easily connected using a TSX™ CDP ●●3 connecting cable 2 to the Dialbase sub-base APE 1B24M 3 installed on the Dialpack terminal 4 equipped with a panel 5 which enables operator dialog.

(1) See pages 3/42 to 3/45

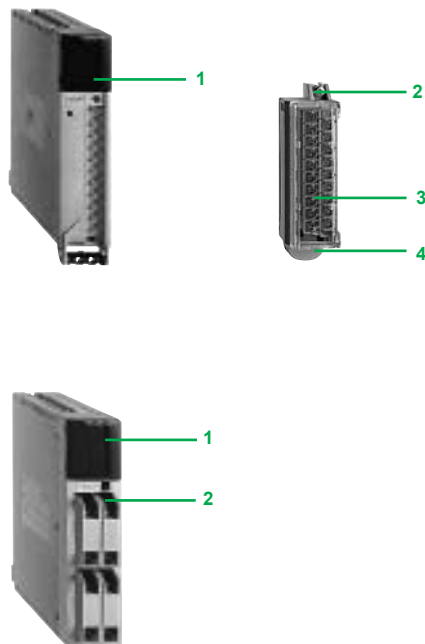

### Description

Discrete I/O modules are standard format (1 slot). They have a plastic case which helps to ensure IP 20 protection of the electronics.

#### I/O modules with screw terminal connection

- 1 A display block for channels and module diagnostics.
- 2 A removable screw terminal for direct connection of the I/O to the sensors and preactuators, TSX™ BLY 01 (connectors to be ordered separately).
- 3 A pivoting cover for accessing the terminal block screws and holding the identification label.
- 4 A rotating support containing the module locating device.

#### I/O modules with connection via HE 10 connector

- 1 A display block for channels and module diagnostics.
- 2 HE 10 connectors, protected by a cover. They are used to connect the I/O to sensors and preactuators either directly, or via Advantys™ Telefast® ABE 7 connection sub-bases.

### Functions

#### I/O assignment

Each module is functionally organized into groups of 8 channels. Each group of channels can be assigned a specific application task.

#### Reactivation of outputs

If a module detected fault has caused an output to trip, the output can be reactivated if no other terminal condition is present. The reactivation command, defined during configuration, can be automatic (reactivation every 10 seconds) or controlled via the program. Reactivation is carried out in groups of 8 channels. This function can be accessed on modules with solid state d.c. outputs. For relay and triac output modules protected by fuse, the same type of reactivation (automatic or via program) is necessary after replacement of one or more fuses.

#### RUN/STOP command

An input can be configured to control the RUN/STOP mode for the PLC. The command is accepted on a rising edge. A STOP command via an input takes priority over a change to RUN via the terminal or via a network command.

#### Output fallback

When an application is placed in STOP mode, outputs must be set to a state which is not harmful to the application. This state, known as the fallback position, is defined for each module when its outputs are configured.

This configuration enables the choice between:

- fallback: channels are set to state 0 or 1 depending on the fallback value entered.
- maintain: outputs retain the state they were in before the PLC stopped.

#### Diagnostic functions

- module diagnostics: any potential hardware problem detected that would prevent normal operation of an output module or fast input module is signaled. Similarly, any module detected internal fault is signaled.
- process diagnostics: sensor/pre-actuator voltage check, terminal block presence check, short-circuit and overload check, sensor voltage check, pre-actuator voltage check.

#### Specific functions of the TSX™ DEY 16FK and TSX™ DMY 28 FK module inputs

- Latching: accepts particularly short pulses with a duration of less than the PLC scan time.
- Event input: enables events to be accepted and helps to ensure their immediate processing (processing on interrupt). These inputs are associated with event processing (EVTi) and defined in configuration mode where: i = 0 to 31, 0 to 63 or 0 to 128 depending on Premium processors model.
- Event processing can be triggered on a rising edge (0→1) or falling edge (1→0) of the associated input. A masking/unmasking function for **TSX DEY 16FK/DMY 28FK** inputs is available in online mode.
- Programmable input filtering: inputs are equipped with filtering which can be configured for each channel. Inputs are filtered by a fixed analog filter which helps ensure a maximum immunity of 0.1 ms for filtering line interference and by a digital filter which can be configured from 0.1 to 7.5 ms in increments of 0.5 ms.

#### Reflex and timer functions for the TSX DMY 28RFX module

Can be used to create applications which require a faster response time than the FAST task or event processing (< 500 [µs]). These control system functions are executed in the module and are independent of the PLC task. They are programmed using Unity™ Pro or PL7™ Junior/Pro software in configuration mode.

#### Removal when powered up

Due to their integrated devices, I/O modules (including application-specific modules) can be removed and connected while powered up.



Functions (continued)					
2/3 wire compatibility					
Type of input	⎓ 24 V type 1 positive logic	⎓ 24/48 V type 2 positive logic	~ 24 V type 2 (1)	~ 24/48 V ~ 100...120 V type 2	~ 200...240 V type 2
3 wire ⎓ sensors, PNP					
3 wire ⎓ sensors, NPN			(1)		
Telemecanique 2-wire ⎓ sensor or others with the following characteristics: - residual voltage, closed ≤ 7 V - minimum switching current ≤ 2.5 mA - residual current, open ≤ 1.5 mA					
2-wire ⎓ / ~ sensor					(2)
2-wire ~ sensor					(2)

Compatible
  Compatible with conditions
  Not compatible

(1) The ~ 24 V inputs can be used as negative logic (source) compatible with 3-wire ⎓ sensor, NPN type, but are not IEC-compliant.  
 (2) In nominal voltage range ~ 220...240 V.



Characteristics	
Environment	
Conformity to standards	IEC 60664, IEC/EN 61131-2, UL 508, CSA 22.2 No. 142
Temperature derating	Characteristics at 60 °C are validated for 60 % of inputs and 60 % of outputs at state 1

Characteristics of input modules ⎓ 24/48 V											
Type of module				TSX™ DEY 08D2/16D2	TSX DEY 16D3	TSX DEY 16A2	TSX DEY 16FK	TSX DEY 32D2K	TSX DEY 64D2K	TSX DEY 32D3K	
Number of inputs				8/16	16	16	16	32	64	32	
Connections				Screw terminal	Screw terminal	Screw terminal	HE 10 connector	HE 10 connector	HE 10 connector	HE 10 connector	
Nominal input values	Voltage	V	⎓ 24 (pos. logic)	⎓ 48 (pos. logic)	⎓ 24 (neg. logic)	⎓ 24 (pos. logic) Fast inputs	⎓ 24 (pos. logic)	⎓ 24 (pos. logic)	⎓ 24 (pos. logic)	⎓ 48 (pos. logic)	
	Current	mA	7	7	16	3.5	3.5	3.5	7		
	Sensor supply (ripple included)	V	19...30	38...60	19...30	19...30	19...30	19...30	38...60		
Input limit values	At state 1	Voltage	V	≥ 11	≥ 30	≤ U <sub>ps</sub> - 14	≥ 11	≥ 11	≥ 11	≥ 30	
		Current	mA	≥ 6,5	≥ 6,5	≥ 6,5	≥ 3	≥ 3	≥ 3	≥ 6,5 (pour U = 30 V)	
	At state 0	Voltage	V	≤ 5	≤ 10	≥ U <sub>ps</sub> - 5	≤ 5	≤ 5	≤ 5	≤ 10	
		Current	mA	≤ 2	≤ 2	≤ 2	≤ 1.5	≤ 1.5	≤ 1.5	≤ 2	
Impedance at entry at state 1				K $\square$	4	7	1.6	6.3	6.3	4	
Response temperature	Typical	ms	4	4	10	Configurable from 0.1 to 7.5	4	4	4		
	Maximum	ms	7	7	20		7	7	7		
Conforming IEC/EN 61131-2				Type 2	Type 2	–	Type 1	Type 1	Type 1	Type 2	
Compatibility 2-wire/3-wire prox. sensor				IEC/EN 60947-5-2			See "Functions" table above			IEC/EN 60947-5-2	
Isolation resistance				M $\square$	> 10 at ⎓ 500 V						
Dielectric strength				V rms	1500 - 50/60 Hz for 1 minute						
Type of input				Current sink			Resistive			Current sink	
Consumption				See page 9/6							
Dissipated power No. = No. of channels				W	1 + 0.15 Nb	1 + 0.3 Nb	1 + 0.4 Nb	1.2 + 0.1 Nb	1 + 0.1 Nb	1.5 + 0.1 Nb	2 + 0.1 Nb

**Characteristics of a.c. input modules**

Type of module			TSX™ DEY 16A2	TSX DEY 16A3	TSX DEY 16A4	TSX DEY 16A5	
<b>Number of inputs</b>			16	16	16	16	
<b>Nominal input values</b>	Voltage	V	~ 24	~ 48	~ 110	~ 220	
	Current	mA	15	16	12	15	
	Frequency	Hz	47...63	47...63	47...63	47...63	
	Sensor supply (ripple included)	V	20...26	40...52	85...132	170...264	
<b>Input limit values</b>	At state 1	Voltage	V	10	29	74	159
		Current	mA	6	6	6	6
	At state 0	Voltage	V	5	10	20	40
		Current	mA	4	4	4	4
<b>Input impedance at state 1 for 24 V</b>			K $\square$	1.6	3.2	9.2	20
<b>Response time</b>	Typical	ms	15	10	10	10	
	Maximum	ms	20	20	20	20	
<b>IEC/EN 61131-2 conformity</b>			Type 2	Type 2	Type 2	Type 2	
<b>Compatibility 2-wire/3-wire prox. sensor</b>			IEC/EN 60947-5-2				
<b>Isolation resistance</b>			M $\square$	> 10 at --- 500 V			
<b>Dialectic strength</b>			V rms	1500 - 50/60 Hz for 1 min			
<b>Type of input</b>				Resistive	Capacitive		
<b>Consumption</b>			See page 9/6				
<b>Dissipated power</b>			W	0,89	0,86	0,83	0,97

**Characteristics of solid state modules with terminal block**

Type of module			TSX™ DSY 08T2/16T2	TSX DSY 08T22	TSX DSY 08T31	TSX DSY 16T3
<b>Output nominal values</b>	Voltage	V	--- 24	--- 24	--- 48	--- 48
	Current	A	0.5	2	1	0.250
<b>Output limit values</b>	Voltage	V	19...30	19...30	38...60	38...60
	Current/channel	A	0.625	2.5	1.25	0.31
	Current/module	A	4/7	14	7	4
<b>Leakage current</b>	At state 0	mA	< 0.5	< 1	< 1	< 0.5
<b>Residual voltage</b>		V	< 1.2	< 0.5	< 1	< 1.5
<b>Min. load impedance</b>		W	48	12	48	192
<b>Response time</b>			1.2 ms	200 $\square$ s	200 $\square$ s	1.2 ms
<b>Switching frequency on inductive load</b>		Hz	0.5/LI <sup>2</sup>			
<b>Built-in protection</b>	Against overvoltages		Yes, by Transil diode			
	Against inversions		Yes, by reverse mounted diode, use a fuse on the + 24 V or + 48 V of the preactuators			
	Against short-circuits and overloads		Electronic tripping on reactivation (automatic or via program)			
<b>Preactuator voltage detection threshold</b>		V	16		34	
<b>Isolation resistance</b>		M $\square$	> 10 sous --- 500 V			
<b>Dielectric strength</b>		V rms	1500 - 50/60 Hz for 1 min			
<b>Consumption</b>			See page 9/6			
<b>Nominal power</b>	Dissipated	W	1/1.1	1.3	2.2	2.4
	Per output x module current		+ (0.75 W)	+ (0.2 W)	+ (0.55 W)	+ (0.85 W)

Characteristics of 50 VA relay output modules			
Type of module			TSX™ DSY 08R5/16R5
Voltage	a.c.	Nominal	V ~ 24...240
		Limit	V ~ 20...264
	d.c.	Nominal	V ≐ 12...24
		Limit	V ≐ 10...34
Thermal current			A 3
Voltage			V 24 48 110 220
a.c. load	AC-12 duty, resistive	Power	VA 50 (5) 50 (6), 110 (4) 110 (6), 220 (4) 220 (6)
	AC-14 and AC-15 duty, inductive	Power	VA 24 (4) 10 (10), 24 (8) 10 (11), 50 (7), 110 (2) 10 (11), 50 (9) 110 (6), 220 (1)
d.c. load	DC-12 duty, resistive	Power	W 24 (6), 40 (3) -
	DC-3 duty, inductive	Power	W 10 (8), 24 (6) -
Response time	Activation		ms < 8
	Deactivation		ms < 10
Type of contact			Normally open
Built-in protection	Against overloads and short-circuits		None, each channel or group of channels must have a fast blow fuse
	Against a.c. inductive overvoltages		None, an RC circuit MOV (ZNO) peak limiter circuit appropriate to the voltage must be mounted in parallel across the terminals of each preactuator
	Against d.c. inductive overvoltages		None, a discharge diode must be fitted across the terminals of each preactuator
Isolation resistance			MΩ > 10 at ≐ 500 V
Dielectric strength			V rms 2000 - 50/60 Hz for 1 min
Consumption			See page 9/6
Dissipated nominal power			W 0.25 W + (0.2 W x No. of outputs at 1)

(1) For 0.1 x 10<sup>6</sup> operating cycles.  
 (2) For 0.15 x 10<sup>6</sup> operating cycles.  
 (3) For 0.3 x 10<sup>6</sup> operating cycles.  
 (4) For 0.5 x 10<sup>6</sup> operating cycles.  
 (5) For 0.7 x 10<sup>6</sup> operating cycles.  
 (6) For 1 x 10<sup>6</sup> operating cycles.  
 (7) For 1.5 x 10<sup>6</sup> operating cycles.  
 (8) For 2 x 10<sup>6</sup> operating cycles.  
 (9) For 3 x 10<sup>6</sup> operating cycles.  
 (10) For 5 x 10<sup>6</sup> operating cycles.  
 (11) For 10 x 10<sup>6</sup> operating cycles.

**Characteristics of 100 VA relay output modules**

Type of module				TSX™ DSY 08R4D			TSX DSY 08R5A			
Operating voltage	a.c.	Nominal	V	–			~ 24...240			
		Limit	V	–			~ 20...264			
	d.c.	Nominal	V	≡ 24...130			≡ 24...48			
		Limit	V	≡ 19...143			≡ 19...60			
Thermal current			A	5			5			
Voltage			V	–			24	48	100...120	220...240
a.c. load	AC-12 duty, resistive	Power	VA	–			100 (5)	100 (6) 200 (4)	220 (6) 440 (4)	440 (6)
	AC-14 and AC-15 duty, inductive	Power	VA	–			50 (4)	20 (10) 50 (8)	20 (11) 110 (7) 220 (2)	20 (11) 110 (9) 220 (6) 440 (1)
Voltage			V	24	48	100...130	24	48		
d.c. load	DC-12 duty, resistive	Power	W	50 (6) 100 (3)	100 (6) 200 (3)	220 (6) 440 (3)	24 (6) 50 (3)	50 (6) 100 (3)		
	DC-3 duty, inductive	Power	W	20 (8) 50 (6)	50 (8) 100 (6)	110 (8) 220 (6)	10 (8) 24 (6)	24 (8) 50 (6)		
Response time	Activation		ms	< 10						
	Deactivation		ms	< 15						
Type of contacts				2 x 2 "O/F", 2 x 2 "F"						
Built-in protection	Against overloads and short-circuits			Interchangeable 6.3 A fast blow fuse per common						
	Against overvoltages			RC circuit and Ge-Mov						
Isolation resistance			MΩ	> 10 at ≡ 500 V						
Dielectric strength			V rms	2000 - 50/60 Hz						
Consumption				See page 9/6						
Dissipated nominal power	No: number of outputs at 1		W	0.25 + 0.24 Nb						

**Characteristics of triac output modules**

Type of module				TSX DSY 08S5		TSX DSY 16S5		TSX DSY 16S4	
Operating voltage	a.c.	Nominal	V	~ 48...240				~ 24...120	
		Limit	V	~ 41...264				~ 20...132	
Permissible current			A	2 A per channel 12 A per module		1 A per channel 12 A per module		1 A per channel 12 A per module	
Response time	Activation		ms	≤ 10					
	Deactivation		ms	≤ 10					
Built-in protection	Against overvoltages			Ge-Mov					
	Against overloads and short-circuits			Fast blow fuse per common ≤ 5 A				Non interchangeable fireproof protection per common, 10 A	
Isolation resistance			MΩ	> 10 at ≡ 500 V					
Dielectric strength			V rms	2000 - 50/60 Hz					
Consumption				See page 9/6				See page 9/6	
Dissipated power				0.5 W + 1 W/A per output		0.85 W + 1 W/A per output		0.85 W + 1 W/A per output	

- (1) For 0.1 x 10<sup>6</sup> operating cycles.
- (2) For 0.15 x 10<sup>6</sup> operating cycles.
- (3) For 0.3 x 10<sup>6</sup> operating cycles.
- (4) For 0.5 x 10<sup>6</sup> operating cycles.
- (5) For 0.7 x 10<sup>6</sup> operating cycles.
- (6) For 1 x 10<sup>6</sup> operating cycles.
- (7) For 1.5 x 10<sup>6</sup> operating cycles.
- (8) For 2 x 10<sup>6</sup> operating cycles.
- (9) For 3 x 10<sup>6</sup> operating cycles.
- (10) For 5 x 10<sup>6</sup> operating cycles.
- (11) For 10 x 10<sup>6</sup> operating cycles.

**Characteristics of solid state output modules with connector**

Type of module			TSX™ DSY 32T2K	TSX DSY 64T2K
<b>Logic</b>			Positive	
<b>Operating voltage d.c.</b> (ripple included)	Nominal	<b>V</b>	≐ 24	
	Limit	<b>V</b>	≐ 19...30, possible up to 34 V, limited to 1 hr per 24 hr period	
<b>Permissible current</b>			0.1 A per channel, - 3.2 A per module	0.1 A per channel, - 5 A per module
<b>Filament lamp max power</b>			1.2	
<b>Residual voltage</b>			< 1.5 for I = 0.1 A	
<b>Response time</b>			1.2	
<b>Paralleling of outputs</b>			Yes: 3 max	
<b>Leakage current</b>			< 0.1 for U = 30 V	
<b>Compatibility with d.c. inputs</b>			IEC 1 and 2	
<b>Built-in protection</b>	Against overvoltages		Yes, transil diode	
	Against overloads and short-circuits		Automatic trip after 15 ms	
	Against polarity inversion		Reverse diode (place a 3 A fuse on the 24 V)	
<b>Load impedance</b>	At state 1	<b>W</b>	> 220	
<b>Isolation resistance</b>			<b>MΩ</b> > 10 at ≐ 500 V	
<b>Dielectric strength</b>			<b>V rms</b> 1500 - 50/60 Hz for 1 minute	
<b>Consumption</b>			See page 9/6	
<b>Dissipated power</b>			1.6 W + 0.1 W/output	2.4 W + 0.1 W/output

**Characteristics of I/O mixed modules with connector**

Type of module			TSX™ DMY 28FK/TSX DMY 28RFK	
			Fast inputs ≐ 24 V	Solid state outputs ≐ 24 V
<b>Nominal values</b>	Voltage	<b>V</b>	≐ 24	
	Current	<b>mA</b>	3.5	
<b>Filament lamp max power</b>			6	
<b>Output limit values</b>	At state 1	Voltage	<b>V</b>	≥ 11
		Current	<b>mA</b>	≥ 3
	At state 0	Voltage	<b>V</b>	≤ 5
		Current	<b>mA</b>	≤ 1.5
<b>Sensor power supply</b> (ripple included)			19...30 (possible up to 30 V, limited to 1 in every 24 hours)	
<b>Output limit values</b>	Voltage	<b>V</b>	19...30 (1)	
	Current/channel	<b>A</b>	0.5	
	Current/module	<b>A</b>	4	
<b>Leakage current</b> At state 0			<b>mA</b> < 1	
<b>Residual voltage</b> At state 1			<b>V</b> < 1.2	
<b>Minimum load impedance</b>			<b>W</b> 48	
<b>Filter time</b>	Default		<b>ms</b> 4	
	Configurable		<b>ms</b> 0.1...7.5 (at intervals of 0.5)	
<b>Response time (2)</b>			<b>ms</b> 0.6	
<b>Type of input</b>			Current sink	
<b>Paralleling of inputs (3)</b>			Yes	
<b>Switching frequency on inductive load</b>			<b>Hz</b> 0.5/LI <sup>2</sup>	
<b>IEC/EN 61131-2 conformity</b>			Yes type 1	
<b>Built-in protection</b>	Against overvoltages		-	
	Against inversions		-	
	Against short-circuits and overloads		<b>ms</b>	15
<b>Compatibility</b>	2-wire proximity sensor		Yes (Telemecanique sensor and < 1.5 mA leakage current)	
	3-wire proximity sensor		Yes	
<b>Preactuator voltage detection threshold</b>			<b>V</b> 16	
<b>Isolation resistance</b>			<b>MΩ</b> > 10 at ≐ 500 V	
<b>Dielectric strength</b>			<b>V rms</b> 1500 - 50/60 Hz for 1 min	
<b>Consumption</b>			See page 9/6	
<b>Dissipated power</b>			1.2 + 0.1 x no. of inputs at 1	-
<b>Temperature derating</b>	Characteristics at 60 °C		Validated for 60 % of inputs at state 1	Validated for 60 % of the maximum current of the module

(1) 34 V possible for 1 hour in every 24 hour period.  
 (2) Outputs are equipped with an electro-magnet rapid demagnetisation circuit. Discharge time for electro-magnets < L/R.  
 (3) This characteristic enables several inputs to be wired in parallel on the same module, or on different modules for input redundancy.

# Modicon® Premium™ automation platform

## Discrete I/O modules



TSX DEY 08D2



TSX DEY 16FK



TSX DEY 32D3K

### References

#### Discrete input modules

Type of current	Input voltage	Connection (1)	IEC/EN 61131 2 conformity	Modularity (no. of channels)	Reference (2)	Weight kg
≡	24 V (pos. log.)	Screw terminal block	Type 2	8 isolated inputs	<b>TSX™ DEY 08D2</b>	0.300
				16 isolated inputs	<b>TSX DEY 16D2</b>	0.300
	48 V (pos. log.)	Screw terminal block	Type 2	16 isolated inputs	<b>TSX DEY 16D3</b>	0.300
	24 V (pos. log.)	HE 10 connector	Type 1	16 isolated fast inputs (2)	<b>TSX DEY 16FK</b>	0.300
				32 isolated inputs	<b>TSX DEY 32D2K</b>	0.300
				64 isolated inputs	<b>TSX DEY 64D2K</b>	0.370
24 V (neg. log.)	Screw terminal block	–	16 isolated inputs	<b>TSX DEY 16A2</b>	0.310	
48 V (pos. log.)	HE 10 connector	Type 2	32 isolated inputs	<b>TSX DEY 32D3K</b>	0.310	
~ 50/60 Hz	24 V	Screw terminal block	Type 2	16 isolated inputs	<b>TSX DEY 16A2</b>	0.310
	48 V	Screw terminal block	Type 2	16 isolated inputs	<b>TSX DEY 16A3</b>	0.320
	100...120 V	Screw terminal block	Type 2	16 isolated inputs	<b>TSX DEY 16A4</b>	0.320
	200...240 V	Screw terminal block	Type 2	16 isolated inputs	<b>TSX DEY 16A5</b>	0.360

(1) By connector: module supplied with cover. By screw terminal block: connection block **TSX BLY 01** to be ordered separately.

(2) Module with isolated fast inputs (filtering from 0.1 to 7.5 ms) can activate the event task.



TSX DSY 16T2



TSX DSY 64T2K



TSX DMY 28FK/28RFK

## References (continued)

## Discrete output modules (screw terminal block not supplied)

Type of current	Output voltage	Connection (1)	IEC/EN 61131-2 conformity	Modularity (no. of channels)	Reference	Weight kg
— solid state	24 V/0.5 A (pos. log.)	Screw terminal block	Yes	8 protected outputs	TSX™ DSY 08T2	0.320
	24 V/2 A (pos. log.)	Screw terminal block	Yes	8 protected outputs	TSX DSY 08T22	0.410
	24 V/0.5 A (pos. log.)	Screw terminal block	Yes	16 protected outputs	TSX DSY 16T2	0.340
	48 V/1 A (pos. log.)	Screw terminal block	Yes	8 protected outputs	TSX DSY 08T31	0.320
	48 V/0.25 A (pos. log.)	Screw terminal block	Yes	16 protected outputs	TSX DSY 16T3	0.340
	24 V 0.1 A per channel (pos. log.)	HE 10 connector	Yes	32 protected outputs 64 protected outputs	TSX DSY 32T2K TSX DSY 64T2K	0.300 0.360
— or ~ relay	— 24 V/3 A, ~ 24 to 240 V/3 A	Screw terminal block	Yes	8 outputs, not protected	TSX DSY 08R5	0.330
				16 outputs, not protected	TSX DSY 16R5	0.380
	— 24 to 48 V/5 A, ~ 24 to 240 V/5 A	Screw terminal block	Yes	8 protected outputs	TSX DSY 08R5A	0.420
— relay	24...120 V 5 A	Screw terminal block	Yes	8 protected outputs	TSX DSY 08R4D	0.370
~ triac	24...120 V 1 A/channel	Screw terminal block	Yes	16 outputs, not protected	TSX DSY 16S4	0.380
	48...240 V 1 A/channel	Screw terminal block	Yes	16 protected outputs	TSX DSY 16S5	0.310
	48...240 V 2 A/channel	Screw terminal block	Yes	8 protected outputs	TSX DSY 08S5	0.340

## Discrete I/O modules

Number of I/O	Connection (1)	No. and type of inputs	No. and type of outputs	IEC/EN 61131-2 conformity	Reference	Weight kg
28	HE 10 connector	16 fast (pos. log.) (2)	12, solid state	Input, type 1 Output, Yes	TSX™ DMY 28FK	0.320
			— 24 V/0.5 A protected 12 reflex or time-delayed — 24 V/0.5 A protected	Input, type 1	TSX DMY 28RFK	0.350

(1) By connector: module supplied with cover. By screw terminal block: connection block TSX BLY 01 to be ordered separately.

(2) Module with isolated fast inputs (filtering from 0.1 to 7.5 ms) can activate the event task.



TSX BLY 01

Connection terminal block			
Designation	Use	Reference	Weight kg
<b>Screw connection terminal block 20-way</b>	To be ordered separately with each I/O module with screw terminal block connection	<b>TSX™ BLY 01</b>	0.100

### Connecting cables for I/O modules fitted with HE 10 connectors

Description	Constitution Use	Section	Length	Reference	Weight kg
<b>20-wire pre-formed cable</b>	1 HE 10 connector with color coded flying leads	0.324 mm <sup>2</sup> (AWG 22)	3 m	<b>TSX CDP 301</b>	0.400
			5 m	<b>TSX CDP 501</b>	0.660
			10 m	<b>TSX CDP 1001</b>	1.210
<b>Rolled ribbon connecting cable</b>	2 HE 10 connectors for Advantys™ for Advantys™ Telefast® ABE 7 system	0.08 mm <sup>2</sup> (AWG 28)	1 m	<b>TSX CDP 102</b>	0.090
			2 m	<b>TSX CDP 202</b>	0.170
			3 m	<b>TSX CDP 302</b>	0.250
<b>Connecting cables</b>	2 HE 10 connectors for Advantys Telefast ABE 7 system	0.324 mm <sup>2</sup> (AWG 22)	0.5 m	<b>TSX CDP 053</b>	0.085
			1 m	<b>TSX CDP 103</b>	0.150
			2 m	<b>TSX CDP 203</b>	0.280
			3 m	<b>TSX CDP 303</b>	0.410
			5 m	<b>TSX CDP 503</b>	0.670
			10 m	<b>TSX CDP 1003</b>	1.180



TSX CDP 01



TSX CDP 02



TSX CDP 03

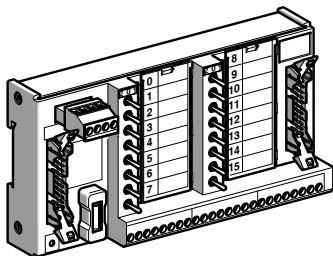

ABE 7TES160

Simulator sub-base			
Designation	Use	Reference	Weight kg
<b>16-channel Advantys Telefast ABE 7 simulator sub-base for discrete I/O</b>	Is comprised of 2 HE 10 connectors which allow it to be inserted between the PLC I/O module and the Telefast I/O sub-base ABE 7H/P/R/S. Enables display, forcing, inhibiting or continuity of discrete I/O	<b>ABE 7TES160</b>	0.350

(1) By connector: module supplied with cover.



**TSX™ DEY 08D2**

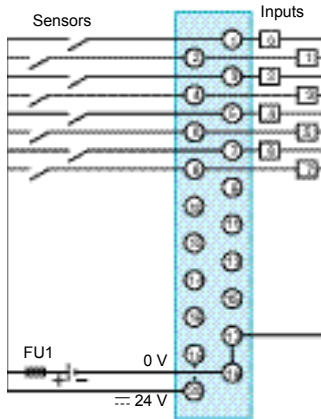

FU1: 0.5 A fast-blow fuse

**TSX DEY 16D2**

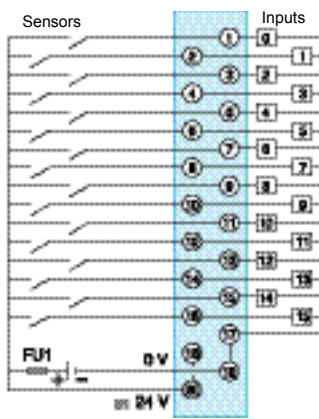

FU1: 0.5 A fast-blow fuse

**TSX DEY 16D3**

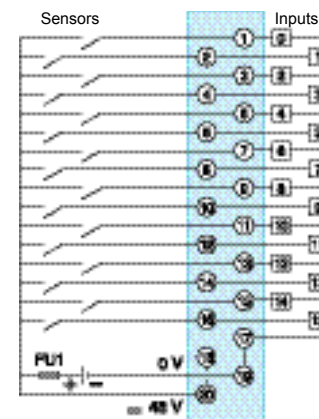

FU1: 0.5 A fast-blow fuse

**TSX DEY 16FK**

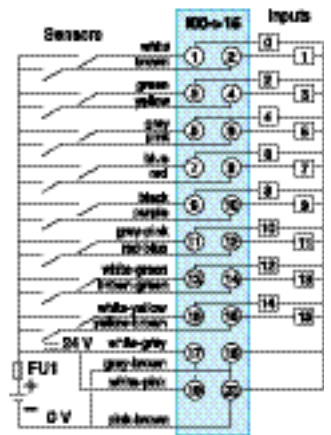

FU1: 0.5 A fast-blow fuse

**TSX DEY 32D2K/64D2K/32D3K**

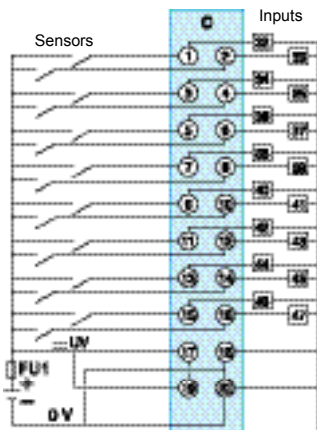

FU1: 0.5 A fast-blow fuse

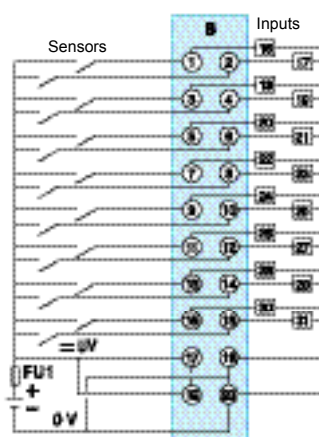
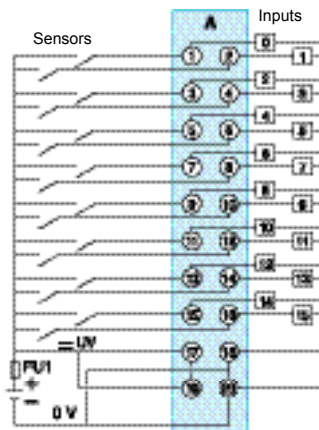

**TSX DEY 16A2 (negative logic)**

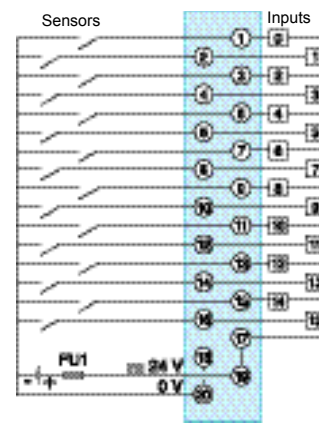

FU1: 0.5 A fast-blow fuse

**TSX DEY 16A2/16A3/16A4/16A5**

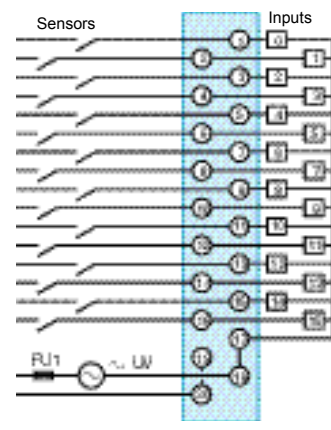

UV:  
 - ~ 24 V for TSX DEY 16A2  
 - ~ 48 V for TSX DEY 16A3  
 - ~ 110 V for TSX DEY 16A4  
 - ~ 220 V for TSX DEY 16A5

FU1: 0.5 A fast-blow fuse

	UV	A	B	C	D
TSX DEY 32D2K	~ 24V	I00 → 15	I16 → 31	-	-
TSX DEY 32D3K	~ 48V	I00 → 15	-	I32 → 47	-
TSX DEY 64D2K	~ 24V	I00 → 15	I16 → 31	I32 → 47	I48 → 63

20-wire preformed cable TSX CDP ●●1: correspondence between HE 10 connector pin and color(s) of wire, see table on page 3/19 of this catalog.

3

**TSX™ DSY 08T2**

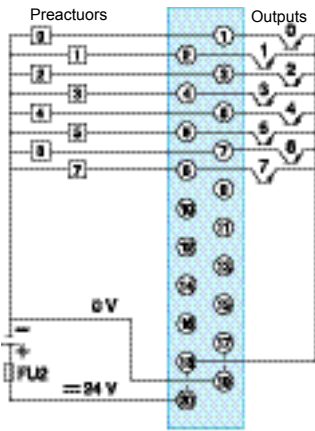

FU2: 6.3 A fast-blow fuse

**TSX DSY 08T22**

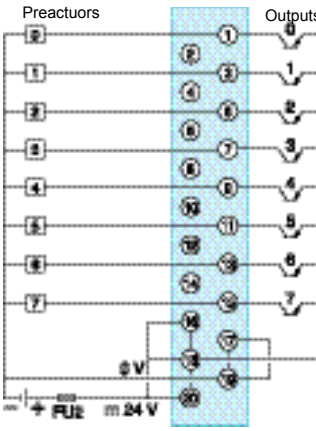

FU2: 16 A fast-blow fuse

**TSX DSY 16T2/16T3**

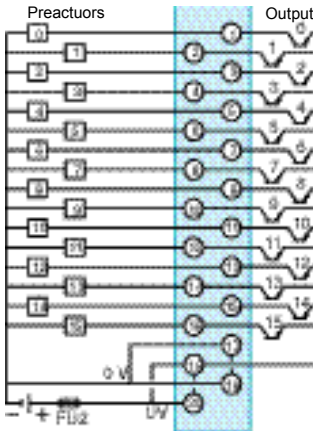

UV: ~ 24 V for TSX DSY 16T2  
~ 48 V for TSX DSY 16T3  
FU2: fast-blow fuse  
6.3 A for TSX DSY 16T2  
10 A for TSX DSY 16T3

**TSX DSY 08T31**

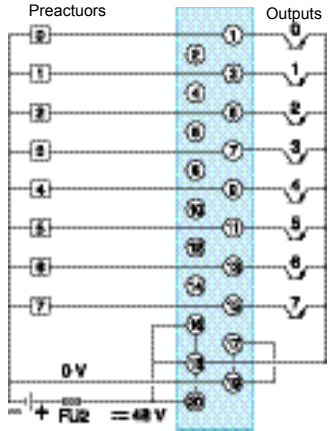

FU2: 10 A fast-blow fuse

**TSX DSY 32T2K/64T2K**

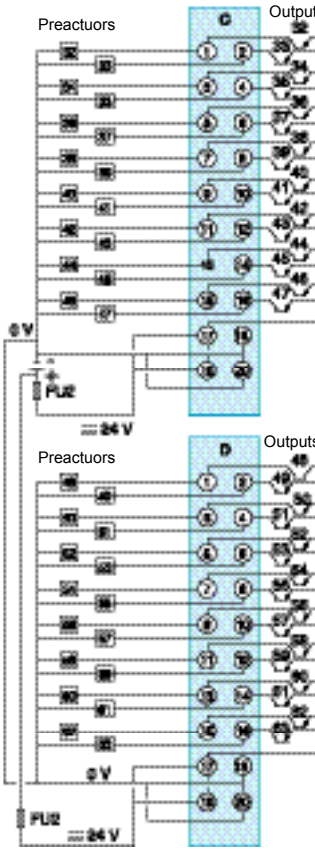

FU2: 2 A fast-blow fuse

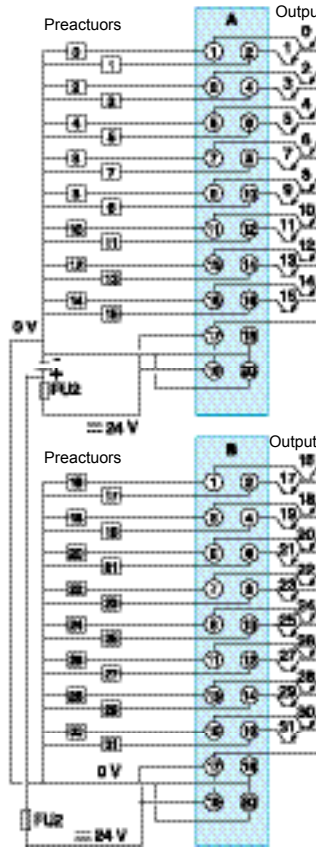

**TSX DSY 08R5/16R5**

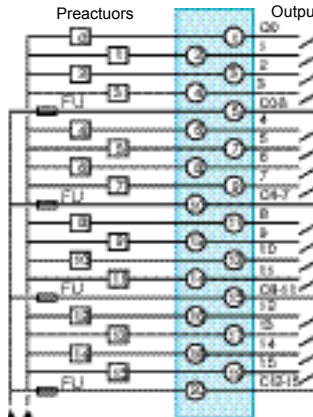

~ 19...240V  
or ~ 24 V  
FU: fuse to be rated according to load

**TSX DSY 08R5A/08R4D**

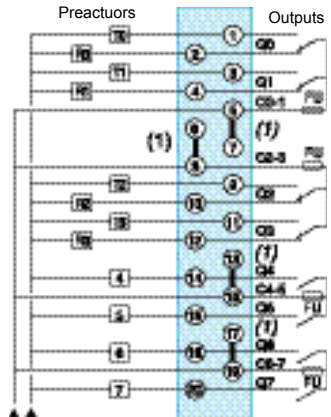

UV:  
- ~ 19...240 V or ~ 19...60 V  
for TSX DSY 08R5A  
- ~ 24...130 V for TSX DSY 08R4D  
FU: 6.3 A fast-blow fuse  
(1) Connection must be made for  
~ 24 V or ~ 24 V power supply

	A	B	C	D
TSX DSY 32T2K	Q00 → 15	Q16 → 31	-	-
TSX DSY 64T2K	Q00 → 15	Q16 → 31	Q32 → 47	Q48 → 63

20-wire preformed cable TSX CDP ●●1: correspondence between HE 10connector pin and color(s) of wire, see table on page 3/19 of this catalog.

**TSX™ DSY16S4**

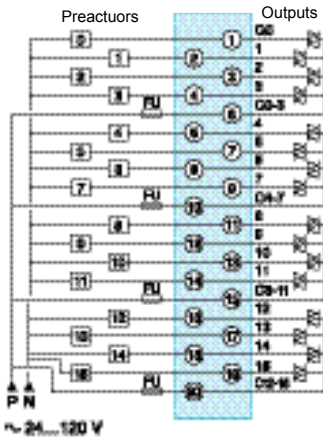

FU: Fusible 6.3 A fast-blow fuse

**TSX DSY 16S5**

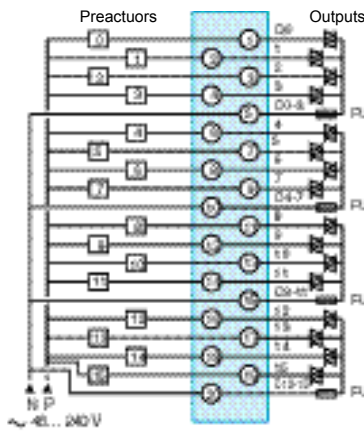

FU: interchangeable 5 A fast-blow fuse

**TSX DSY 08S5**

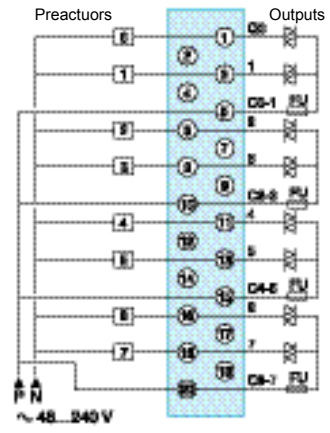

FU: interchangeable 5 A fast-blow fuse

**TSX DMY 28FK/28RFK**

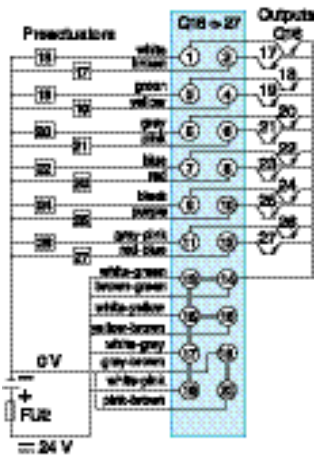

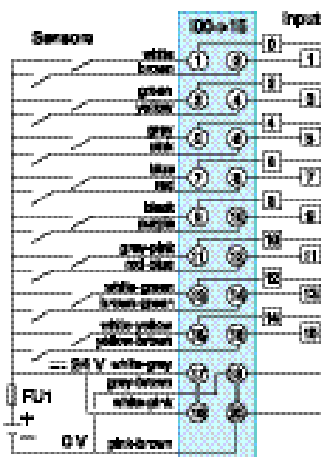

FU2: 2 A fast-blow fuse



FU1: Fusible 0.5 A fast-blow fuse

**20-wire preformed cable TSX™ CDP ●●1:  
correspondence between HE 10 connector pin  
and color(s) of wire, see table below**

1	white
2	brown
3	green
4	yellow
5	grey
6	rose
7	blue
8	red
9	black
10	violet
11	grey/rose
12	red/blue
13	white/green
14	brown/green
15	white/yellow
16	yellow/brown
17	white/grey
18	grey/brown
19	white/rose
20	rose/brown

Applications		Analog inputs		
				
<b>Type of I/O</b>		Low level isolated inputs, thermocouples, temperature probes	Thermocouple inputs	High level inputs with common point
<b>Type</b>		Multirange	Multirange	Voltage/current
<b>Range</b>	Voltage	$\pm 10\text{ V}$ , $\pm 5\text{ V}$ , $0\dots 10\text{ V}$ , $0\dots 5\text{ V}$ , $1\dots 5\text{ V}$	$-80\dots +80\text{ mV}$	$\pm 10\text{ V}$ , $0\dots 10\text{ V}$ , $0\dots 5\text{ V}$ , $1\dots 5\text{ V}$
	Current	$4\dots 20\text{ mA}$ , $0\dots 20\text{ mA}$ , external shunt supplied	–	$0\dots 20\text{ mA}$ , $4\dots 20\text{ mA}$
	Thermocouple, temperature probes	B, E, J, K, L, N, R, S, T, U thermocouples Pt 100, Pt 1000, Ni 1000, 2 or 4-wire temperature probes	Thermocouples B, E, J, K, L, N, R, S, T, U	
<b>Modularity</b>		4 channels	16 channels	8 channels
<b>Isolation</b>		Between channels: $\sim 2830\text{ V rms}$ Between bus and channels: $\sim 1780\text{ V rms}$ Between channels and ground: $\sim 1780\text{ V rms}$	Between channels: $\pm 100\text{ V}$ Between bus and channels: $\sim 1000\text{ V rms}$ Between channels and ground: $\sim 1000\text{ V rms}$	Between channels: common point Between bus and channels: $\sim 1000\text{ V rms}$ Between channels and ground: $\sim 1000\text{ V rms}$
<b>Read time</b>		550 ms	1120 ms (normal scan) 70 ms/channel used (fast scan)	27 ms (normal scan) 3 ms/channel used (fast scan)
<b>Response time</b>		User-definable filtering 0 to 68.5 s	User-definable filtering 0.04 Te to 0.012 Te (Te: module scan time)	User-definable filtering 0 to 3.44 s
<b>Resolution</b>		16 bits	16 bits	12 bits
<b>Connection</b>		20-way screw terminal: TSX BLY 01	Two 25-way SUB-D connectors  or via 2 Advantys™ Telefast® sub-bases ABE 7CPA12	25-way SUB-D connector  or via 1 Advantys Telefast sub-base ABE 7CPA02/03
<b>Type of module</b>		<b>TSX™ AEY 414</b>	<b>TSX AEY 1614</b>	<b>TSX AEY 800</b>
<b>Pages</b>		3/26		



High level inputs with common point

High level isolated inputs between channels

High level input with common point

Voltage/current
± 10 V, 0...10 V, 0...5 V, 1...5 V
0...20 mA, 4...20 mA

16 channels

8 channels

4 channels

Between channels: common point.  
Between bus and channels: ~ 1000 V rms  
Between channels and ground: ~ 1000 V rms

Between channels: ± 200 V  
Between bus and channels: ~ 1000 V rms  
Between channels and ground: ~ 1000 V rms

Between channels: common point  
Between bus and channels: ~ 1000 V rms  
Between channels and ground: ~ 1000 V rms

51 ms (normal scan)  
3 ms/channel used (fast scan)

126.4 ms (normal scan)  
3.3 ms/channel used (fast scan)

1 ms

User-definable filtering  
0 to 6.50 s

User-definable filtering  
0 to 3.82 s

–

12 bits

16 bits

–

Two 25-way SUB-D connectors  
or via 2 Advantys™ Telefast® sub-bases ABE 7CPA02/03

25-way SUB-D connector  
or via 1 Advantys Telefast sub-base ABE 7CPA02/31

25-way SUB-D connector  
or via 1 Advantys Telefast sub-base ABE 7CPA03/21

**TSX™ AEY 1600**

**TSX AEY 810**

**TSX AEY 420**



Isolated outputs between channels

Outputs with common point

Voltage/current
± 10 V
0...20 mA, 4...20 mA

4 channels

8 channels

Between channels: ~ 1500 V rms  
Between bus and channels: ~ 1500 V rms  
Between channels and ground: ~ 1500 V rms

Between channels: common point  
Between bus and channels: ~ 1000 V rms  
Between channels and ground: ~ 1000 V rms

–

–

2.5 ms

5 ms

11 bits + sign

13 bits + sign for voltage  
13 bits for current

20-way screw terminal: TSX BLY 01

25-way SUB-D connector  
or via 1 Advantys Telefast sub-base ABE 7CPA02

**TSX™ ASY 410**

**TSX ASY 800**

Connection using screw terminal block

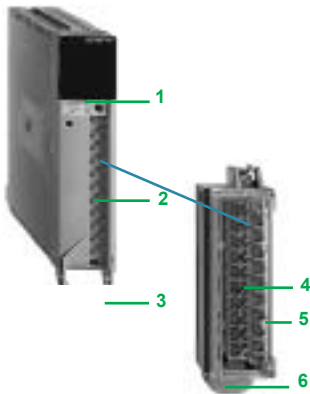

Connection using SUB-D connector

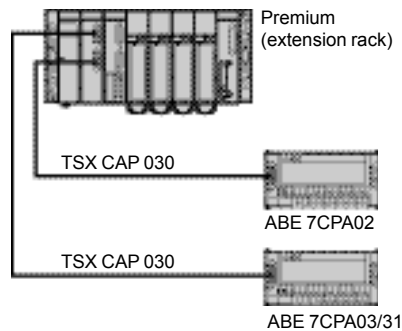

### Presentation

Analog I/O modules for Modicon® Premium™ PLCs are equipped with :

- Either one 25-way SUB-D connector (TSX™ AEY 420/800/810 and TSX™ ASY 800)
- Or two 25-way SUB-D connectors (TSX AEY 1600/1614)
- Or a screw terminal block (TSX AEY 414, TSX ASY 410)

They can be installed in any position in TSX™ RKY ●●● racks except for the positions reserved for power supply modules. Analog I/O modules can be removed while the PLC is powered up.

The maximum number of analog channels in a Premium configuration (12...256 channels) depends on the processor used, see pages 1/10, 1/20 and 1/28.

### Description

The front panels of TSX AEY/ASY analog I/O modules include:

- 1 display and module diagnostics block.
- 2 connector for receiving the screw terminal block.
- 3 rotating support containing the module locating device.
- 4 removable screw terminal for direct connection of the I/O to the sensors and pre-actuators TSX BLY 01 (to be ordered separately).
- 5 pivoting cover for accessing the terminal block screws and holding the identification label.
- 6 rotating support containing the module locating device .
- 7 25-way SUB-D connector for connecting the sensors.

**Note:** The TSX ASY 800 modules have on the front panel a screw terminal for external 24 VR connection. See page 3/26

### Connection principle for TSX™ AEY/ASY modules with SUB-D connector

The Advantys™ Telefast® ABE 7 pre-wired system simplifies the installation of modules by providing access to the inputs (or outputs) at the screw terminals. Connection is via a TSX CAP 030/100 3 or 10 m shielded cable equipped with SUB-D connectors at either end.

- The Telefast ABE 7CPA02 sub-base enables 8 channels to be connected.
- The Telefast ABE 7CPA03/31 sub-base enables the connection of 8 channels and:

□ provides channel by channel supply for 2 and 4-wire sensors with  $\pm$  24 V for sub-base **ABE 7CPA03**,

□ channel by channel isolated supply for 2 and 4-wire 24 V sensors for sub-base **ABE 7CPA31**,

□ helps ensure continuity of current loops when the SUB-D connector is removed,

□ protects the current shunt within the modules against overvoltages.

- The Advantys Telefast **ABE 7CPA12** sub-base enables 16 thermocouples to be connected with 2 **TSX CAP 030/100** cordsets. The terminal block is fitted with a temperature probe for cold junction compensation.

### TSX™ AEY 420, 800/810, 1600 analog input modules

**TSX AEY ●●●** modules are high level analog input modules with 4 inputs for the **TSX AEY 420** module, 8 inputs for **TSX AEY 800/810** modules and 16 inputs for the **TSX AEY 1600** module.

Used with sensors or transmitters, they perform monitoring, measurement and process control functions for continuous processes.

Depending on the choice made during configuration, **TSX AEY 420/800/810/1600** modules offer the following ranges for each of their inputs  $\pm 10$  V,  $0 \dots 10$  V,  $0 \dots 5$  V,  $1 \dots 5$  V,  $0 \dots 20$  mA,  $4 \dots 20$  mA.

#### Functions

- Scanning of input channels, protection against overvoltages, adaptation of signals by analog filtering, scanning by solid state multiplexing.
- Adaptation to input signals: gain selection, drift compensation.
- Digitisation of signals: 12-bit analog/digital conversion for **TSX AEY 800/1600** and 16 bit analog/digital conversion for **TSX AEY 420/810**.
- Converting input measurements to user format: recalibration coefficient, filtering, scaling.
- Module monitoring: conversion circuit test, range overshoot test, terminal block presence test, "watchdog" test.
- Isolation of input channels on **TSX AEY 810**.
- Fast processing of inputs (1 ms) on **TSX AEY 420**.

### TSX™ AEY 414/1614 analog input modules

The **TSX AEY 414** module is a multirange input module with 4 channels isolated from each other.

Depending on the choice made during configuration, the following ranges are available for each of its inputs:

- thermocouples B, E, J, K, N, R, S, T, U or  $-13 \dots +63$  mV electrical range.

- 2 or 4-wire Pt 100, Pt 1000, Ni 1000 temperature probe, or ohmic range:  $0 \dots 400 \square$ ,  $0 \dots 3850 \square$ .

- High level  $\pm 10$  V,  $0 \dots 10$  V,  $\pm 5$  V,  $0 \dots 5$  V ( $0 \dots 20$  mA with external shunt) or  $1 \dots 5$  V,  $4 \dots 20$  mA ( $4 \dots 20$  mA with external shunt).

The **TSX AEY 1614** module is an analog input module with 16 thermocouple inputs. Depending on the selections made during configuration, the following range is available for each of the input channels (supporting a common mode between them of  $\sim 250$  V or  $\sim 280$  V): thermocouples B, E, J, K, L, N, R, S, T, U, or electrical range  $\pm 80$  mV.

#### Functions

- Scanning of input channels, gain selection according to input signals, multiplexing.
- Digitisation of input signals.
- Converting input measurements to user format: recalibration coefficient, linearisation, cold junction compensation, filtering, scaling.
- Module monitoring: conversion circuit test, range overshoot test, terminal block presence test, sensor link test, "watchdog" test.

### TSX™ ASY 410, 800 analog output modules

The **TSX ASY 410** module has 4 analog outputs isolated from each other, and the **TSX ASY 800** module has 8 outputs with common point. Depending on the choice made during configuration, the modules offer the following range for each of its outputs:  $\pm 10$  V,  $0 \dots 20$  mA and  $4 \dots 20$  mA without external supply.

#### Functions

- Protection of the module against overvoltages.
- Adaptation to the different actuators: voltage or current output.
- Conversion of digital signals to analog signals: 11 bits + sign for **TSX ASY 410** and 13 bits + sign for **TSX ASY 800**.
- Transforming application data into data which can be used by the digital/analog converter.
- Module monitoring and detected fault indication to the application: converter test, range overshoot test, terminal block presence test, "watchdog" test.

#### Setup

Unity™ Pro or PL7™ Junior/Pro software performs configuration and debugging functions:

- Choice of modules used.
- Configuration of channels according to the type of module: scanning (normal or fast), cold junction compensation (internal or external), range, filtering, display format, task (MAST or FAST), detection of terminal block presence, wiring check.
- Debugging, access to certain parameter settings, module/channel diagnostics, forcing, calibration.

Characteristics of analog input modules											
Type of input module		TSX™	AEY 800		AEY 1600		AEY 810			AEY 420	
Number of channels			8		16		8			4	
Input range			± 10 V, 0...10 V, 0...5 V, 1...5 V, 0...20 mA, 4...20 mA								
Analog/digital conversion			12 bits				16 bits				
Read time	Normal scan	ms	27		51		29.7			1	
	Fast scan	ms	3 x (no. of channels used + 1)				3.3 x (no. of channels used + 1)			–	
Tolerance	At 25 °C	%FS	± 10 V	0...5 V	0...20 mA	± 10 V	0...5 V	0...20 mA	± 10 V	0...5 V	0...20 mA
			0...10 V	1...5 V	4...20 mA	0...10 V	1...5 V	4...20 mA	0...10 V	1...5 V	4...20 mA
			0.19/0.1 (1)	0.15/0.1 (1)	0.25/0.16 (1)	0.244	0.13	0.142	0.1	0.2	0.2
0...60 °C	%FS	0.22/ 0.13 (1)	0.22/ 0.13 (1)	0.41/0.32 (1)	0.305	0.191	0.12	0.2	0.4	0.4	
		Isolation		Between channels and bus	V rms	1000					
			Between channels and ground	V rms	1000						
			Between channels	≡ V	Common point		± 200		Common point		
Common mode between channels			None				± 200		None		
Max. overvoltage/overcurrent on the inputs			± 30 V voltage ± 30 mA en current								
Standards			IEC/EN 61131-2								
Consumption		mA	See page 9/6								
Type of input module		TSX AEY 414						TSX AEY 1614			
Number of channels			4						16		
Input range			- B, E, J, K, L, N, R, S, T, U thermocouples - -13...+63 mV electrical range - Pt 100, Pt 1000, Ni 1000 2 or 4-wire temperature probes - 0...400 □, 0...3850 □ ohmic range: - ± 10 V, 0...10 V, ± 5 V, 0...5 V (0...20 mA with external shunt) - 1...5 V, 4...20 mA (4...20 mA with external shunt)						- B, E, J, K, L, N, R, S, T, U thermocouples - ± 80 mV		
Analog/digital conversion			16 bits						16 bits		
Read time	Normal scan	ms	550						70 ms/channel		
	Fast scan	ms	–						–		
Tolerance	At 25 °C	%FS	See "Characteristics" table above						See "Characteristics" table above		
	0...60 °C	%FS	See "Characteristics" table above						See "Characteristics" table above		
Isolation	Between channels and bus	V rms	1780						1000		
	Between channels and ground	V rms	1780						1000		
	Between channels	V rms	2830						–		
Common mode		V	~ 240 or ≡ 100 between channels and ground ~ 415 or ≡ 200 between channels						~ 240 between channels and ground ≡ 250 or ~ 280 between channels		
Max. overvoltage/overcurrent on the inputs			± 30 V powered up without 250 □ external resistance ± 15 V powered down without 250 □ external resistance ± 25 mA powered up/down without 250 □ external shunt						≡ ± 30 V in differential mode		
Standards			Sensors: IEC/EN 60584, IEC/EN 60751, NF C42-324 PLC: IEC/EN 61131-2								
Consumption		mA	See page 9/6								

(1) The 1<sup>st</sup> value corresponds to the tolerance of the TSX AEY 800 module, the 2<sup>nd</sup>, to the TSX AEY 1600.



**Characteristics of analog input modules (continued)**

**Input range for TSX™ AEY 414**

Voltage/current range			± 10 V	0...10 V	± 5 V	0...5 V	1...5 V	0...20 mA	4...20 mA	13...63 mV	0...4000 □	0...3850 □
Tolerance at 25 °C	%FS (1)	°C	0.27	0.16	0.27	0.22	0.27	0.36	0.45	0.19	0.13	0.22
		°C	0.50	0.39	0.50	0.45	0.56	0.69	0.86	0.44	0.27	0.48
Temperature probe range			Pt 100			Pt 1000		Ni 1000				
Tolerance at 25 °C	°C		1.2			2.5		1				
			2.4			5		2				
Thermocouple range			B	E	J	K	L	N	R	S	T	U
Tolerance at 25 °C	IC (2)	°C	3.5	6.1	7.3	7.8	7.5	6	6	6.6	6.6	5.4
	EC (3)	°C	1.5	1.5	1.8	2.3	2	2	3.2	3.4	1.5	1.5
Tolerance at 0...60 °C	CIC (2)	°C	8.1	8.1	9.5	10.5	9.8	8.7	11	12	8.8	7.3
	EC (3)	°C	3.5	3.2	3.8	4.7	4.1	4.3	7.7	8.5	3.2	3.1

**Input range for TSX AEY 1614**

Thermocouple range			B	E	J	K	L	N	R	S	T	U
Tolerance at 25 °C (4)	°C		2.5	0.8	0.9	1	0.9	1.1	2.1	2.2	1	1
			4	1.2	1.4	1.6	1.4	1.7	2.4	3.7	1.3	1.3

**Characteristics of analog output modules**

Type of output module			TSX™ ASY 410	TSX ASY 800
Number of channels			4	8
Output range			± 10 V, 0...20 mA and 4...20 mA, output supplied by PLC (or 24 V SELV external on TSX ASY 800, see page 8/25)	
Analog/digital conversion			11 bits + sign	13 bits + sign (voltage), 13 bits current
Conversion time		ms	2,5	5
Maximum resolution			Voltage output 5.12 mV (5), Current output 10.25 □A (6)	Voltage output 1.28 mV, Current output 2.56 □A
Output load			Voltage output, impedance > 1 k□, load < 0.1 □F, Current output, impedance < 600 □, load < 300 □H	
Measurement tolerance as a % of FS	Voltage output, FS = 10 V	%FS	0.45 to 25 °C, 0.75 from 0 to 60 °C	
	Current output, FS = 20 mA	%FS	± 0.14 to 25 °C, ± 0.28 from 0 to 60 °C	
Isolation between	Channels and bus	V rms	1500	
	Channels and ground	V rms	500	
	Channels	V rms	1500	
Type of protection			Short-circuits and overload	
Max. voltage without damage		V	± 30	
Standards			IEC 1131	
Consumption		mA	See page 9/6	

(1) %FS: tolerance as a % of full scale.

(2) IC: with internal cold junction compensation.

(3) EC: with external cold junction compensation (with class A Pt 100 probe on channel 0).

(4) Tolerance, regardless of type of internal or external cold junction compensation (via Advantys Telefast ABE 7 sub-base or with class A Pt 100 probe).

(5) Value given for TSX ASY 410 (software version: II > 10), for TSX ASY 410 (software version: II ≤ 10). This value is 4.88 mV.

(6) Value given for TSX ASY 410 (software version: II > 10), for TSX ASY 410 (software version: II ≤ 10). This value is 9.77 □A.



# Modicon® Premium™ automation platform

## Analog I/O modules



TSX AEY 420/800



TSX ASY 410/AEY 414



TSX AEY 1600/1614



TSX ASY 800

### Analog input modules

Type of inputs	Input signal range	Resolution	Connection	No. of channels	Reference	Weight kg
Analog, high level with common point	$\pm 10$ V, 0...10 V, 0...5 V, 1...5 V, 0...20 mA, 4...20 mA	16 bits	1 x 25-way SUB-D connector	4 fast channels	<b>TSX™ AEY 420</b>	0.330
Analog, low level isolated	$\pm 10$ V, 0...10 V, 0...5 V, 1...5 V, $\pm 5$ V, 0...20 mA, 4...20 mA, -13...+63 mV, 0...400 $\square$ , 0...3850 $\square$ , temperature probe, thermocouple	16 bits	Screw terminal block (1)	4 channels	<b>TSX AEY 414</b>	0.320
Analog, high level with common point	$\pm 10$ V, 0...10 V, 0...5 V, 1...5 V, 0...20 mA, 4...20 mA	12 bits	1 x 25-way SUB-D connector	8 channels	<b>TSX AEY 800</b>	0.310
			2 x 25-way SUB-D connectors	16 channels	<b>TSX AEY 1600</b>	0.340
Analog, low level isolated	$\pm 10$ V, 0...10 V, 0...5 V, 1...5 V, 0...20 mA, 4...20 mA	16 bits	1 x 25-way SUB-D connector	8 channels	<b>TSX AEY 810</b>	0.330
Thermocouple	$\pm 63$ mV, (B, E, J, K, L, N, R, S, T, U)	16 bits	2 x 25-way SUB-D connectors	16 channels	<b>TSX AEY 1614</b>	0.350

### Analog output modules

Type of outputs	Output signal range	Resolution	Connection	No. of channels	Reference (1)	Weight kg
Analog, isolated	$\pm 10$ V, 0...20 mA, 4...20 mA	11 bits + sign	Screw terminal block (1)	4 channels	<b>TSX™ ASY 410</b>	0.350
Analog with common point	$\pm 10$ V, 0...20 mA, 4...20 mA	13 bits + sign	1 x 25-way SUB-D connector	8 channels (2)	<b>TSX ASY 800</b>	—

(1) **TSX BLY 01** screw terminal block not supplied. To be ordered separately.

(2) The number of **TSX ASY 800** modules is limited to 1 per rack with standard format power supply, to 2 per rack with double format power supply (when this supplies the  $\approx 24$  VR voltage required by outputs).



ABE-7CPA00

### Connection accessories

Description	Compatible with module	Use	Type of terminal block	Reference	Weight kg
Advantys™ Telefast® ABE 7 sub-bases	TSX™ AEY 800 TSX AEY 810 TSX AEY 1600 TSX™ ASY 800 (1)	Distribution of 8 channels on screw terminals	Screw	ABE 7CPA02	0.290
	TSX AEY 420 TSX AEY 800 TSX AEY 1600	Distribution of 8 channels with common point on screw terminals, protected sensor supply, continuity of current loops during disconnection, protection against overvoltages	Screw	ABE 7CPA03	0.330
	TSX AEY 810	Distribution of 8 isolated channels on screw terminals, channel by channel sensor supply (without common point), protection against overvoltages	Screw	ABE 7CPA31	0.410
	TSX AEY 1614	Distribution of 16 channels on screw terminals, integrates temperature probe for external cold junction compensation	Screw	ABE 7CPA12	0.360
	TSX AEY 420 TSX ASY 410 (2)	Distribution of 4 channels on screw terminals	Screw	ABE 7CPA21	0.200

Description	Compatible with module	Use	Length	Reference	Weight kg
Connection cordsets	TSX AEY 420 TSX AEY 800 TSX AEY 810 TSX AEY 1600 TSX AEY 1614 (3)	Link between 25-way SUB-D connectors of analog I/O modules and ABE 7CPA00 sub-bases Length 3 m	3 m	TSX CAP 030	0.670
			10 m	TSX CAP 100	1,120
			TSX ASY 800		
	TSX ASY 410	Link between module and ABE 7CPA21 sub-bases (4)	1.5 m	ABF Y25S150	0.500
			2 m	ABF Y25S200	0.560
3 m			ABF Y25S300	0.740	
5 m			ABF Y25S500	0.920	
Screw terminal 20-way	TSX AEY 414 TSX ASY 410	To be ordered separately with each I/O module for connection via screw terminal block	Screw	TSX BLY 01	0.100



TSX BLY 01

### Replacement part

Description	Compatible with module	Use	Reference	Weight kg
Set of 4 resistors 250 Ω	TSX AEY 414	Adaptation for current range (resistors supplied with TSX AEY 414)	TSX AAK2	0.020

(1) Can be used with TSX AEY 420 module.

(2) Can be used with TSX ASY 410 module by using the ABF Y25S000 cordsets.

(3) Necessity to use two TSX CAP 030 cables to connect the ABE 7CPA12 sub-base.

(4) Includes the TSX BLY 01 20-way screw terminal block.

**Module type**

**Monobloc IP 20 distributed I/O**

**Modicon® Momentum™**



**Type of communication with Modicon® Premium™ platform**

Ethernet TCP/IP  
Modbus Plus™  
Fipio®  
Profibus DP™  
INTERBUS®

**Max. number per connexion points**

1 base with 1 communicator

**Discrete inputs/outputs**    Number of channels

---

Input voltage

---

Output voltage

Base of 16 I, 32 I, 8 O, 16 O, 32 O, 10 I/8 O, 16 I/8 O, 16 I/12 O and 16 I/16 O

---

--- 24 V, ~ 120 V and ~ 230 V

---

--- 24 V, ~ 120 V and ~ 230 V and relay

**Analog inputs/outputs**

Bases 8 I, 16 I or 4 O voltage/current  
Base 4 I thermocouple or RTD

**Counting**

Base 2 channels 10 kHz/200 kHz

---

Base 6 I/3 O ~ 120 V with 1 Modbus port

**Type of input/output connectors**

Screw or spring terminal blocks

**Housing type**

Plastic

**Module type**

**170 AD●**

**Pages**

Consult our catalog "Modicon Momentum automation platform"

**Optimum IP 20 distributed I/O**

**Advantys™ OTB**



Ethernet TCP/IP  
CANopen  
Modbus® (RS 485)

1 interface module and 7 Twido I/O expansion modules

12 I/O (interface module)  
8 I, 16 I, 32 I, 8 O, 16 O, 32 O, 4 I/4 O and 16 I/8 O (expansion modules)

--- 24 V and ~ 120 V

--- 24 V and relay

2 I, 4 I, 8 I, 1 O, 2 O, 2 I/1 O and 4 I/2 O (expansion modules)  
voltage/current, thermocouple or temperature probe

Integrated in interface module:  
- 2 channels 5 kHz/20 kHz  
- 2 PWM function channels

-

Removable screw terminal blocks (interface module)  
Removable screw or non-removable spring terminal blocks or  
HE 10 connector (expansion modules)  
Plastic

**OTB 1●0 DM9LP**

Consult our catalog "Advantys OTB distributed I/O"

**Modular IP 20 distributed I/O**

**Advantys™ STB**



Ethernet TCP/IP  
Modbus Plus™  
Fipio®  
Profibus DP™  
INTERBUS®

1 "NIM" interface module + 32 I/O modules

Module of 2 I, 4 I, 6 I, 16 I, 2 O, 4 O, 6 O or 16 O

--- 24 V, ~ 115 V and ~ 230 V

--- 24 V, ~ 115/230 V and relay

Modules 2 I and 2 O voltage/current  
Module 2 I thermocouple or RTD

Module 1 channel 40 kHz

Parallel interface module for TeSys Quickfit and TeSys U motor-starters

Screw or spring connectors

Plastic

**STB D●●/A●●**

Consult our catalog "Advantys STB distributed I/O"

# Modicon® Premium™ automation platform

## Advantys™ IP67 I/O splitter boxes and interfaces

3

Splitter box and interface type		Passive splitter boxes	Monobloc I/O interfaces
		Advantys™ Telefast® ABE9 splitter boxes	TSX™ E•F I/O modules
			
Type of communication with Modicon® Premium™ platform		Direct	Fipio
Inputs/Outputs	Discrete	8 I/O (4 channels), 16 I/O (8 channels)	8 I, 16 I, 8 I/8 O or 8 O
	Analog	–	–
Functions		Connection of 1 to 16 sensors/actuors LED indicator depending on model	Connection of 1 to 16 sensors/actuors LED indicator
Type of connectors	Sensors/actuators	Female M12 connectors, 5-ways	Female M12 connectors, 5-ways
	Automation	Female M23 connectors or Multicore cable (length 5 m or 10 m)	Female M23 connectors
Housing type		Plastic	Plastic
Module type		ABE 9C12●●C23 ABE 9C12●●L05/L10	TSX E•F
Pages		Please, consult our catalog pages on the website, <a href="http://www.schneider-electric.com">www.schneider-electric.com</a>	3/32

**Monobloc I/O splitter boxes and interfaces**

**Modular I/O splitter boxes**

**Advantys™ FTB splitter boxes**

**Advantys™ IP 67 interfaces**

**Advantys™ FTM splitter boxes**



CANopen  
INTERBUS®  
Profibus-DP™

CANopen  
Profibus-DP

AS-Interface®

CANopen  
Profibus-DP

16 I, 8 I/8 O, 12 I/4 O,  
16 configurable I/O, 8 I + 8 configurable I/O

4 I, 3 O, 4O,  
2 I/2 O, 4 I/4 O, 4 I/3 O

8 I, 16 I,  
8 configurable I/O, 16 configurable I/O

–

–

4 I/4 O

Connection of 1 to 16 sensors/actuors  
LED indicators

Connection of 1 to 8 sensors/actuors  
LED indicators

Connection of 1 to 256 sensors/actuors per bus  
module

Female M12 connectors, 5-ways

Female M12 connectors, 5-ways

Female M8 or M12 connectors, depending on  
model

Male and female M12 connectors  
Terminal block with INTERBUS

Direct connection on  
AS-Interface flat cable      Male M12 connectors

Male and female M12 connectors

Plastic

Metal

Plastic

Plastic

**FTB 1●●●●P●**

**FTB 1●●●●S0**

**ASI 67FPP●●●**

**ASI 67FMP●●●**

**FTM 1●●10/FTM 1D●●●/FTM 1A●04**

Please, consult our catalog pages on the website,  
[www.schneider-electric.com](http://www.schneider-electric.com)

Please, consult our catalog "Machine &  
Installations with industrial communications"

Please, consult our catalog pages on the  
website, [www.schneider-electric.com](http://www.schneider-electric.com)

## Presentation

De-centralizing the I/O meets the requirements of both users and machine manufacturers while maintaining performance comparable with that of a centralized structure.

Fipio® bus dust and damp proof I/O modules are used to create distributed control systems by removing the need for enclosures, improving connections and thus increasing the availability of installations. These IP 67 protection modules also offer the possibility of locating the standard I/O interfaces used in the processes or machines in harsh environments (oil jets, water jets, dust etc).

Unity™ Pro or PL7™ Junior/Pro programming software is used for the software configuration and installation of the dust and damp proof I/O modules on the Fipio bus.

There are 4 types of Fipio bus dust and damp proof I/O module:

- Input module, 8 channels,  $\bar{\text{---}}$  24 V IEC type 2: **TSX™ EEF 08D2.**
- Input module, 16 channels  $\bar{\text{---}}$  24 V IEC type 2: **TSX EEF 16D2.**
- Mixed module, 8 IEC type 2 inputs/8 x 0.5 A transistor outputs,  $\bar{\text{---}}$  24 V: **TSX™ EMF 16DT2.**
- Output module, 8 channels, 2 A transistor outputs,  $\bar{\text{---}}$  24 V: **TSX ESF 08T22.**

Furthermore, this module design offers a number of special functions:

- Remote power supply: the Fipio modules, inputs, and Fipio communication power supplies are provided using a single cable. Each remote power supply can be used to power up to 31 modules.
- A daisy-chained module can be changed without interrupting the bus.
- An operator terminal can be connected at any point on the bus.
- Short-circuits in the sensor power supply can occur without causing the bus to malfunction.
- A Fipio bus fast connection system using cables and M23 connectors.
- A sensor/preactuator fast connection system using an M12 connector.

The Fipio bus dust and damp proof I/O modules conform to the following standards and approvals:

- IEC/EN 61131.
- CNOMO.
- Fipio® certification.
- DIN.
- UL certification.
- CSA certification.
- C€ mark.

## Architecture

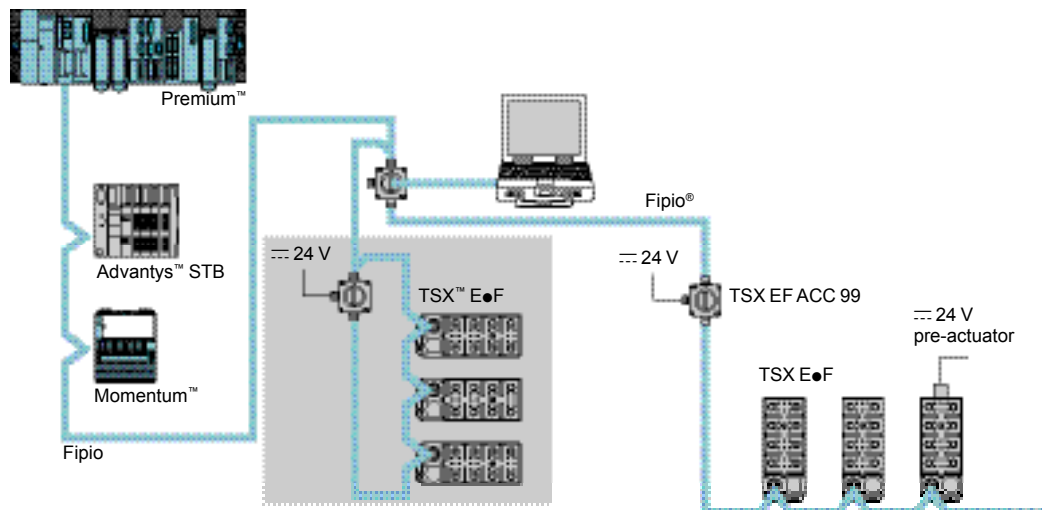



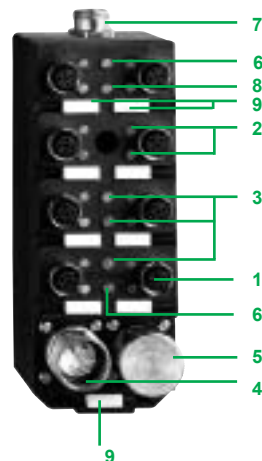
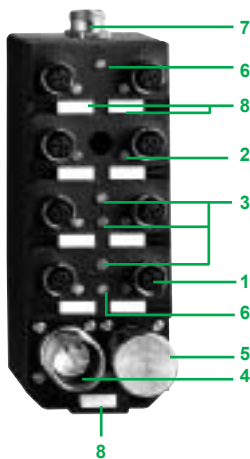
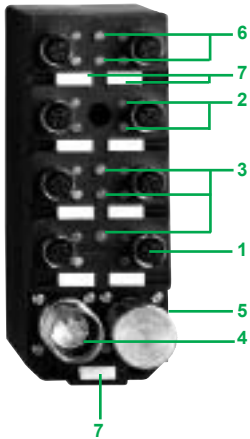

### Architecture (continued)

The Fipio® fieldbus is a standard relating to communication between different automation components where the IP 67 dust and damp proof I/O are located remotely.

Each segment supports up to 31 IP 67 I/O modules over a maximum distance of 1000 m. Because the IP 67 I/O modules have a remote power supply, the voltage drops caused by the connected modules limit the maximum distances between each T-junction box (from the one which provides the  $\pm$  24 V power supply) and the remote powered IP 67 I/O modules. For the calculation of these distances, see page Modicon® Premium™ Cat Interior Rev 11-09/38.

The use of electrical or electrical/fiber-optic repeaters allows the connection of up to 98 IP 67 I/O modules on 5 segments over a maximum distance of 15,000 m.

### Description

#### TSX™ EEF 08D2 and TSX EEF 16D2 modules

Dust and damp proof input modules are monobloc type in an IP 67 casing and include:

- 1 8 female M12 type fast connectors for connecting the sensors (2 input channels per connector for the 16-channel model).
  - 2 8 or 16 channel status indicator lamps.
  - 3 3 status indicator lamps for module operation and integrated communication.
  - 4 Dust and damp proof male M23 type connector for connection of the Fipio bus, the  $\pm$  24 V power supply for the sensor and the internal electronics of the module.
  - 5 Access to the addressing micro-switch.
  - 6 1 or 2 sensor power supply status indicators.
  - 7 9 slots for channel and module referencing labels (10 labels supplied).
- Two sealing plugs for M12 connectors are supplied with every module.

#### TSX™ ESF 08T22 module

Dust and damp proof output modules are monobloc type in an IP 67 casing and include:

- 1 8 female M12 type fast connectors for connecting the preactuators.
  - 2 8 channel status indicator lamps.
  - 3 3 status indicator lamps for module operation and integrated communication.
  - 4 Dust and damp proof male M23 type connector for connection of the Fipio bus and the power supply for the internal electronics of the module.
  - 5 Access to the addressing micro-switch.
  - 6 2 preactuator power supply presence indicators.
  - 7 A male 7/8" type connector for connecting the two  $\pm$  24 V preactuator power supplies.
  - 8 9 slots for channel and module referencing labels (10 labels supplied).
- Two sealing plugs for M12 connectors are supplied with the module.

#### TSX™ EMF 16DT2 module

Dust and damp proof I/O modules are monobloc type in an IP 67 casing and include:

- 1 8 female M12 type fast connectors of which 4 are for connecting the sensors and 4 for the preactuators (2 input channels or 2 output channels per connector).
  - 2 16 channel status indicator lamps.
  - 3 3 status indicator lamps for module operation and integrated communication.
  - 4 Dust and damp proof male M23 type connector for connection of the Fipio bus, the  $\pm$  24 V power supply for the sensor and the internal electronics of the module.
  - 5 Access to the addressing micro-switch.
  - 6 2 preactuator power supply presence indicators.
  - 7 A male 7/8" type connector for connecting the two  $\pm$  24 V preactuator power supplies.
  - 8 1 sensor power supply status indicator.
  - 9 9 slots for channel and module referencing labels (10 labels supplied).
- Two sealing plugs for M12 connectors are supplied with the module.

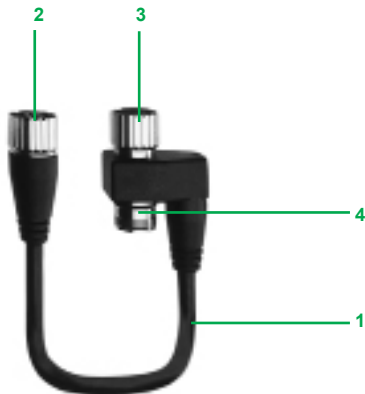

3

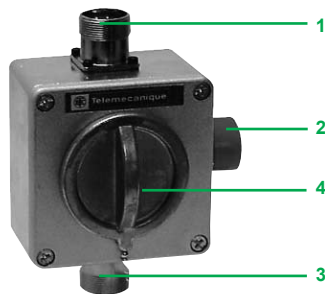

## Description (continued)

### TSX™ EF ACC 2●●● Fipio® bus connecting cables

TSX EF ACC 2●●● cables are used to carry Fipio bus signals and the  $\bar{\text{---}}$  24 V power supply for the sensors and the internal electronics of TSX EEF/ESF/EMF modules.

They are comprised of:

- 1 A trunk cable, with a 150  $\square$  shielded twisted pair and a 1.5 mm<sup>2</sup> power supply pair, 0.2, 1, 3, 7, 12 or 25 m long depending on the model (radius of curvature 30 mm,  $\varnothing$  9.5 mm).

At one end:

- 2 An insulated IP 67 male connector, with M23 type ring, 6-way for Fipio connection to the preceding module n-1 (or to the upstream T-junction box).

At the other end: an insulated double connector comprising :

- 3 An IP 67 female connector, with M23 type ring, 6-way for connection to module n.
- 4 An IP 67 female connector, with M23 type thread, 6-way for an outgoing cable of the same type for connection to the next module n+1 (or to the downstream T-junction box).

Use of this cable on the dust and damp proof I/O modules:

- Locks access to the module's Fipio addressing microswitch.
- Helps to ensure continuity of the Fipio bus even if the module is disconnected (when replacing a module, for example). Patented system.

### TSX EF ACC 99 T-junction box

The IP 65 T-junction box is comprised of:

- 1 A male M23 type soldering connector for connecting the Fipio bus (incoming and outgoing).
- 2 A male 7/8" type connector for connecting the  $\bar{\text{---}}$  24 V power supply for the remote powered modules, fitted with a protective plug.
- 3 A female M23 type connector for connecting the Fipio bus (outgoing), fitted with a sealing plug.
- 4 An access cover for the 9-way female SUB-D connector used for connecting an operator terminal.

## Functions

Remote dust and damp proof I/O modules can be integrated with the following monitoring devices:

### ■ Inputs:

- power supply status monitoring in groups of 8 channels. Indicated on the front panel by the SF1 and SF2 indicator lamps (red).
- module status monitoring. Indicated on the front panel by the ERR indicator lamp (red).

One status bit for the module is available at PLC processor level for use by the user program.

### ■ Outputs:

- pre-actuator power supply presence monitoring in groups of 4 channels. Indicated on the front panel by the US1 and US2 indicator lamps (green). A power supply presence bit is associated with each indicator lamp.
- short-circuit monitoring for each channel. Indicated on the front panel by an indicator lamp for each channel (red). There is one status bit per channel (for 8 channel modules) or per group of 2 channels (for mixed modules). In addition, there is one bit per group of 4 channels which can be used to reset the channels remotely.
- module status monitoring. Indicated on the front panel by the ERR indicator lamp (red). One status bit for the module is also available.

In the case of the **TSX™ EMF 16DT2** mixed module, a diagnostic bit allows the origin of the power supply status to be determined (input or output power supply).

## Environmental characteristics

Type of module			TSX™ EEF 08D2/EEF 16D2/ESF 08T22/EMF 16DT2	TSX™ ACC 99
Temperature	Operation	°C	0...60	
	Storage	°C	0...60	
Degree of protection			IP 67	IP 65
Altitude		m	0...2000	
Protection against shocks			15 gn/11 ms	
Operating positions			Any position	

## Input characteristics

Type of module			TSX EEF 08D2	TSX EEF 16D2	TSX™ EMF 16DT2
Inputs channels	Number		8 inputs	16 inputs	8 inputs (8 outputs, see page 3/36 of this catalog)
	Groups of channels		1	2	1
Conforms to IEC/EN 61131-2			Yes, type 2		
Proximity sensor 2-wire/3-wire compatibility			Yes		
Nominal values	Voltage	V	≐ 24 (positive logic)		
	Current	mA	7		
	Sensor power supply	V	≐ 19.2...30 (ripple included)		
Inputs limit values	Voltage	At state 0	V	≤ 5	
		At state 1	V	≥ 11	
	Current	At state 0	mA	< 2	
		At state 1	mA	≥ 6 to 11 V	
Built-in protection against short-circuits		mA	350 per 4 channels group		
Typical response time	State 0 to 1	ms	3.5		
	State 1 to 0	ms	3.5		
Sensor power supply monitoring		V	≐ 14...18		
Isolation	Between channels		None		
	Between bus and internal logic	V	~ 500		
Consumption		mA	80 with 5-two-wire sensor inputs (1)	130 with 10 two-wire sensor inputs (1)	See "Consumption" page 3/36 of this catalog

(1) + 10mA per additional input and + 10 mA per 3-wire sensor input.

Output characteristics			
Type of module		TSX™ ESF 08T22	TSX™ EMF 16DT2
<b>Type of outputs</b>		Solid state	Solid state
<b>Output channels</b>	Number	8 outputs	8 outputs (8 inputs, see "Input Characteristics" page 3/35 of this catalog)
	Groups of channels	2 groups of 4 channels	
<b>Nominal values</b>	Voltage	V --- 24	
	Current	A 2	0.5
<b>Output limit values</b>	Voltage	V --- 19.2...30	
	Current per channel	A 2.5	0.625
	Current per group of 4 channels	A 8	2
	At 40 °C	A 4.8	1.2
	At 60 °C		
<b>Leakage current at state 0</b>		mA < 1	
<b>Residual voltage at state 1</b>		V < 0.5 to 2 A	< 0.5 to 0.5 A
<b>Response time</b>		ms < 0.5 (resistive load)	
<b>Preactuator power supply monitoring</b>		V --- 14...18	
<b>Built-in protection</b>	Against overvoltage	Yes, by transil diode	
	Against short-circuits and overloads	A 4.5	1.5
		by thermal circuit-breaker	
<b>Isolation</b>	Between channels of the same group	Non	
	Between output channel groups	V rms ~ 60	
	Between output channel groups and internal logic	V rms ~ 60	
	Between input channels and output channels	V rms –	~ 60
	Between bus and internal logic	V ~ 500	
<b>Consumption</b>		mA 80 with 5 outputs at state 1 (1)	130 with 5 two-wire sensor inputs and 5 output at state 1 (1) (2)

(1) + 10 mA per additional output at state 1.  
 (2) + 10 mA per additional input and + 10 mA per 3-wire sensor input.

**Connections**

**TBX™ EEF 08D2 inputs**

**Mechanical contacts**

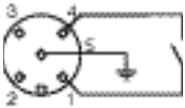

**2-wire sensors**

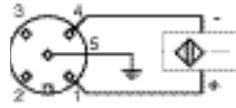

**3-wire sensors**

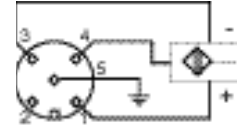

**TBX EEF 16D2/TSX EMF 16DT2 inputs**

**Mechanical contacts**

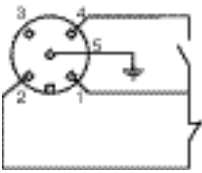

**2-wire sensors**

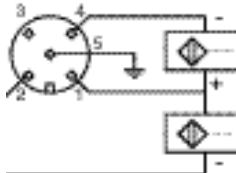

**3-wire sensors**

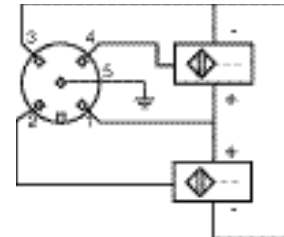

**TBX™ ESF 08T22 outputs**

**Direct wiring**

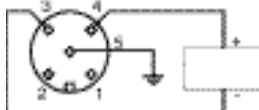

**TBX EMF 16DT2 outputs**

**Direct wiring**

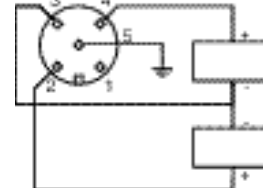

**Pre-actuator power supply**

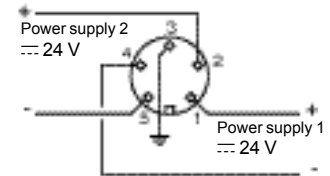

**Dimensions, mounting**

**TSX™ E•F inputs/outputs**

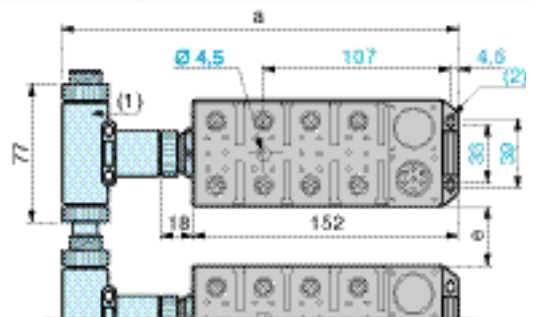
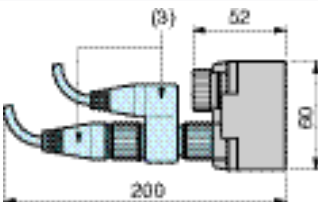

	a	e
TSX E•F + TSX EF CT 03	222	87
TSX E•F + TSX EF CF 03	252	1

(1) TSX EF CT 03  
(2) 2 oblong holes Ø 4.5  
(3) TSX EFACC ●●●

**TSX™ EF ACC 99 T-junction box**

**Rear mounting**

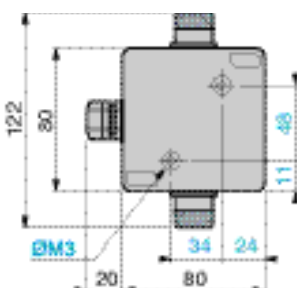

**Front mounting**

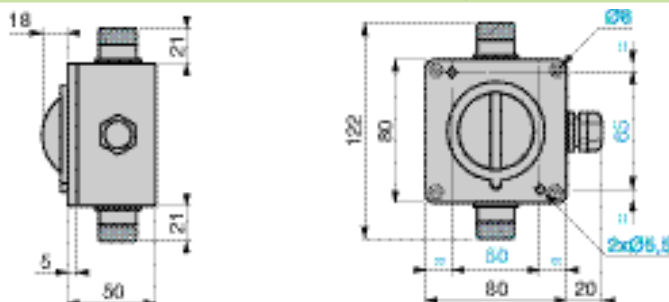

3

**Dust and damp proof input/output wiring system**

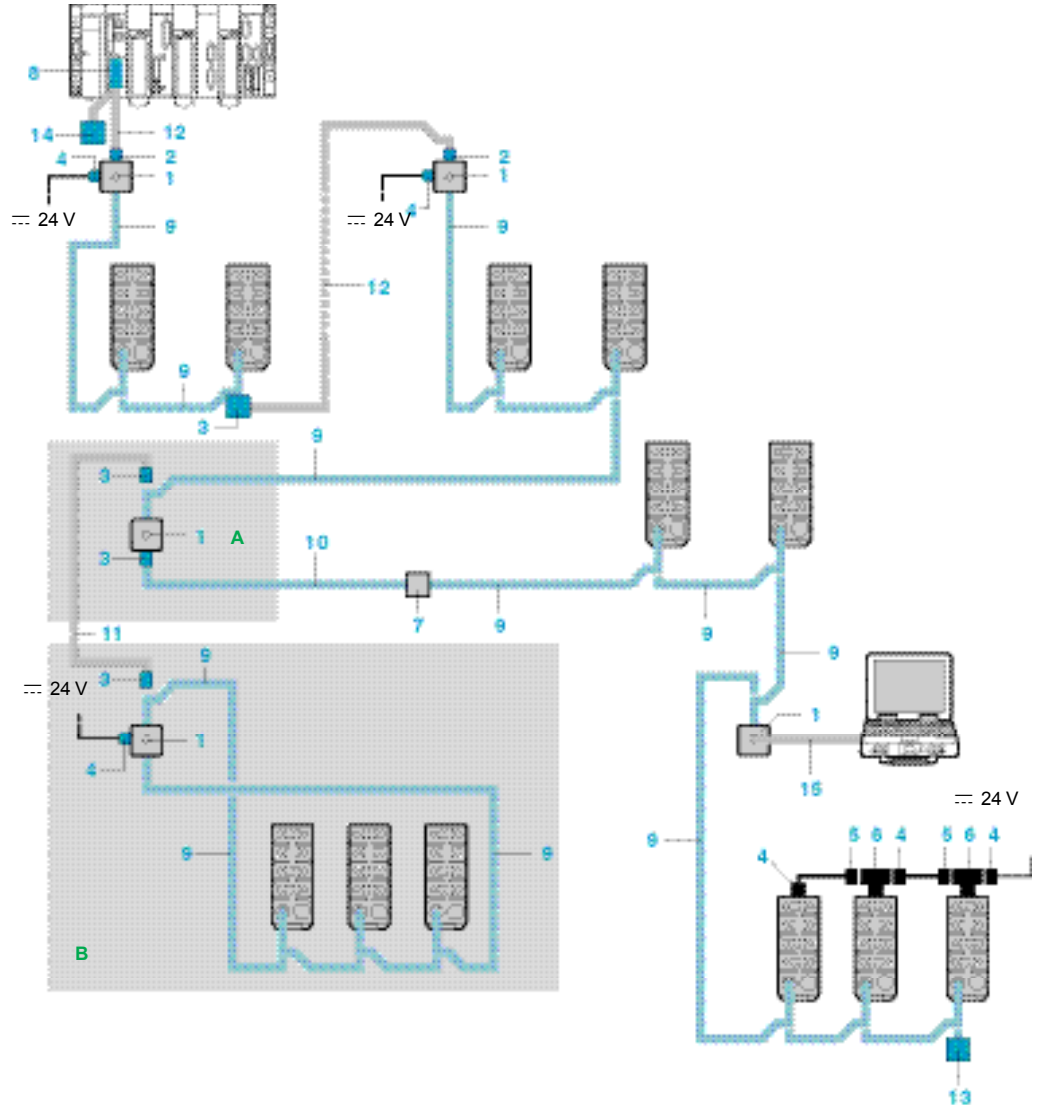

A: Main junction box  
 B: Remote powered T-junction box

**Control of 24 V voltage drop**

The dust and damp proof module power supply is carried by Fipio® cables, which means that the maximum distance from each TSX™ EF ACC 99 T-junction box depends on the type of 24 V power supply and the number of I/O modules. The power supply voltage of the last module must be no lower than 19.2 V. Typical voltage drops are given in the table below (1):

Number of input/output modules	m	Distance between T-junction box (used with 24 V remote supply) and last input/output module											
		10	20	30	50	75	100	125	150	200	250	300	
5	V	0.09	0.18	0.28	0.46	0.7	0.9	1.2	1.4	1.9	2.3	2.8	
10	V	0.17	0.34	0.51	0.86	1.3	1.7	2.1	2.6	3.4	4.3	5.1	
15	V	0.25	0.5	0.75	1.25	1.9	2.5	3.1	3.7	5	6.2	7.5	
20	V	0.32	0.65	0.98	1.63	2.5	3.3	4	4.9	6.5	8.2	9.8	
25	V	0.4	0.8	1.2	2	3	4	5	6	8.1	10	12	
30	V	0.48	0.96	1.45	2.4	3.6	4.8	6	7.2	9.6	12	14.5	

(1) The typical values are given for connecting 2-wire sensors. If using 3-wire sensors, apply a coefficient of 1.77 to these voltage drop values.

Example: Use of a 24 V ± 3% power supply  
 Over a distance of 100 m and connecting 30 dust and damp proof I/O modules.  
 The voltage drop is (24 x 0.97) - 4.8 = 18.48 V (which is less than the permitted 19.2 V). It is necessary to insert a second 24 V power supply via a TSX™ EF ACC 99 T-junction box (distance to be defined and verified according to the installation topology).

### T-junction box

- 1 TSX™ EF ACC 99: IP 65 Fipio bus T-junction box, used to connect the  $\overline{24}$  V power supply intended for dust and damp proof I/O. It also has a 9-way female SUB-D connector for an operator terminal. This box also serves as the main Fipio bus junction box **A** as well as for connecting the  $\overline{24}$  V T-junction power supply (example **B**).

### Connectors

- 2 TSX EF CF 01: IP 67 female soldering connector with M23 type ring, 6-way for connection of Fipio bus and  $\overline{24}$  V power supply. This type of connector is used at the ends of **TSX FP CA/CC/CP/CR ●00** cables.
- 3 TSX EF CM 01: IP 67 male soldering connector with M23 type ring, 6-way for connection of Fipio bus and  $\overline{24}$  V power supply. This type of connector is used at the ends of **TSX FP CA/CC/CP/CR ●00** cables.
- 4 TSX EF CF 03: IP 67 female 7/8" type screw connector, 5-way for  $\overline{24}$  V power supply connection. This type of connector is used for the  $\overline{24}$  V power supply of the TSX ESF/EMF I/O modules and the **TSX EF ACC 99** T-junction box. The maximum current permitted for each connector contact is 8 A.
- 5 TSX EF CM 03: IP 67 male 7/8" type screw connector, 5-way for connection to a **TSX EF CT 03** T-connector used for the  $\overline{24}$  V pre-actuator power supply.
- 6 TSX EF CT 03: IP 67 7/8" type T-connector, 5-way for daisy-chaining the  $\overline{24}$  V pre-actuator power supply. The maximum current permitted for each connector contact is 8 A.
- 7 TSX EF CF 02: IP 67 female soldering connector with M23 type thread, 6-way for extending Fipio **TSX FP CP ●00** cables.
- 8 TSX™ FP ACC 2 or TSX FP ACC 12: 9-way SUB-D connectors for Fipio/Fipway connection to PLC. Used for daisy chain or tap link connection (90° output high or low, 45° output high or low).

### Cables

- 9 TSX EF ACC 2●●●●: trunk cable, a 150  $\square$  shielded twisted pair and a 1.5 mm<sup>2</sup> power supply pair. Fitted with an M23 male connector and a double M23 female/female connector.
- 10 TSX FP CP ●00: trunk cable, a 150  $\square$  shielded twisted pair and a 1.5 mm<sup>2</sup> power supply pair ( $\varnothing$  9.5 mm). Wire ends free to fit IP 67 M23 type soldering connectors **TSX EF CF 01/02** and **TSX EM CM 01**.
- 11 TSX FP CC ●00: tap link cable, double shielded twisted pair 150  $\square$  ( $\varnothing$  8 mm) for normal environments and use inside buildings. Wire ends free to fit IP 67 M23 type soldering connector **TSX EF CM 01**.
- 12 TSX FP CA ●00: trunk cable, shielded twisted pair 150  $\square$  ( $\varnothing$  8 mm) for normal environments and use inside buildings.  
TSX FP CR ●00: trunk cable, shielded twisted pair 150  $\square$  ( $\varnothing$  8 mm) for harsh environments and use outside buildings.  
Wire ends free to fit IP 67 M23 type soldering connectors **TSX EF CF 01/02** and **TSX EF CM 01**.

### Other components

- 13 TSX EF ACC 7: IP 67 M23 type line terminator, to be placed at one or both ends of the segment, depending on the use.
- 14 TSX FP ACC 7: IP 20 line terminator (set of 2), to be placed at one or both ends of the segment, depending on the use.
- 15 TSX FP CG 0●0: tap link connecting cable for **TSX FPP 10** PCMCIA card for TSX Micro/Premium PLC and PC compatibles.

### Calculation of bus length

The total length of a bus is the sum of the lengths of the trunk cables plus the lengths (multiplied by 2) of the tap link cables.

i.e. in the example opposite, the length of the cables is:  $\Sigma 12 + \Sigma 9 + \Sigma 10 + (2 \times \Sigma 11)$ .

3



TSX ESF 08T22



TSX EEF 16D2



TSX EMF 16DT2



TSX EF ACC 99



TSX EF CF 01



TSX EF CM



TSX EF CF 02



TSX EF CT 03



TSX EF ACC 7



TSX EF CF 03

### Dust and damp proof input/output modules (IP 67)

Number of I/O	No and type of inputs	No and type of outputs	Inputs characteristics	Connection via	Reference	Weight kg
8	8 24 V	–	IEC type 2 positive logic	8 female M12 connectors	TSX™ EEF 08D2	0.500
	–	8 solid state 24 V/2A	–	8 female M12 connectors	TSX™ ESF 08T22	0.540
16	16 24 V	–	IEC type 2 positive logic	8 female M12 connectors	TSX EEF 16D2	0.500
	8 24 V	8 solid state 24 V/0.5A	IEC type 2 positive logic	8 female M12 connectors	TSX™ EMF 16DT2	0.540

### Fipio® bus IP67 connection accessories

Type	Use	No. (1)	Reference	Weight kg
------	-----	---------	-----------	-----------

#### Fipio bus T-junction box

1 male M23 1 female M23 1 male 7/8"	Trunk cable tap-off via two M23 connectors Remote 24 V power supply distribution via 7/8" connector PC compatible terminal connection via 9-way female SUB-D 9 connector	1	TSX™ EF ACC 99	0.715
---	--	---	----------------	-------

#### M23 type soldering connectors

Female	Equipment for TSX FP CA/CC/CP bus cables	2	TSX EF CF 01	0.080
Male	Equipment for TSX FP CA/CC/CP bus cables	3	TSX EF CM 01	0.080
Female	Extension for TSX FP CA bus trunk cables	7	TSX EF CF 02	0.075

#### 7/8" type screw connectors

Female	Equipment for 24 V preactuator power supply	4	TSX EF CF 03	0.050
Male	Equipment for 24 V preactuator power supply	5	TSX EF CM 03	0.050
T	24 V preactuator power supply daisy chain on TSX E•F I/O modules	6	TSX EF CT 03	0.095

#### M23 type line terminator

Male	To place at the ends of the Fipio segment requiring IP 67 protection	13	TSX EF ACC 7	0.085
------	--	----	--------------	-------

### IP 20 connection accessories for Fipio bus

Type	Use	No. (1)	Reference	Weight kg
------	-----	---------	-----------	-----------

#### 9-pin SUB-D connectors

Female zamac	Bus connection for Fipio manager output on Premium™ PLCs	8	TSX™ FP ACC 2	0.080
Female insulating	Bus connection for Fipio manager output on Premium PLCs	8	TSX FP ACC 12	0.040

#### Line terminator (set of 2)

2-wire connection	To place at the ends of the Fipio segment (IP 20 protection)	14	TSX FP ACC 7	0.020
-------------------	--	----	--------------	-------

#### Other Fipio accessories

See page 5/88 –

(1) For key to numbers, see pages 3/38 and 3/39.



# Modicon® Premium™ automation platform

## Discrete I/O IP 67 modules on Fipio® bus



TSX EF ACC 20●●

### Fipio® bus connecting cables

Type	Use	No. (1)	Length	Reference	Weight kg
<b>Trunk cables with M23 moulded connections (patented)</b>					
Ø 9.5 mm, 1 shielded twisted pair, 1 pair, 1.5 mm <sup>2</sup> for remote power supply	Fipio bus and --- 24 V power supply	9	0.2 m	TSX™ EF ACC 2002	0.245
	Equipped with 1 male M23 connector and 1 double female M23 connector		1 m	TSX EF ACC 2010	0.340
			3 m	TSX EF ACC 2030	0.580
			7 m	TSX EF ACC 2070	1.020
			12 m	TSX EF ACC 20120	1.645
			25 m	TSX EF ACC 20250	3.180

### Trunk cables to be fitted with M23 connectors

Ø 8 mm, 1 shielded twisted pair	Fipio bus, for use in normal environments (2) inside buildings	12	100 m	TSX™ FP CA 100	5.680
			200 m	TSX FP CA 200	10.920
			500 m	TSX FP CA 200	30.000
Ø 9.5 mm, 1 shielded twisted pair, 1 pair, 1.5 mm <sup>2</sup> for remote power supply	Fipio bus, for use in harsh environments (3) and outside buildings or in garland	12	100 m	TSX FP CR 100	7.680
			200 m	TSX FP CR 200	14.920
			500 m	TSX FP CR 500	40.000
Ø 9.5 mm, 1 shielded twisted pair, 1 pair, 1.5 mm <sup>2</sup> for remote power supply	Fipio bus and --- 24 V power supply	10	100 m	TSX FP CP 100	5.680
	To be fitted with M23 connectors, according to use		500 m	TSX FP CP 500	30.000

### Tap-off cables

Ø 8 mm, 2 shielded twisted pairs	Fipio bus tap-off (between 2 TSX EF ACC 99 T-junction boxes)	11	100 m	TSX FP CC 100	5.680
			200 m	TSX FP CC 200	10.920
			500 m	TSX FP CC 500	30.000

### Replacement parts

Use	Unit reference	Weight kg
<b>Strip of 10 referencing labels</b>		
For referencing I/O modules and I/O channel connectors	XZ LG101	0.010
<b>IP 67 sealing plugs</b>		
For M12 type connectors	XZ LG102	0.005
For M23 type connectors	170 XTS 050 00	0.140

(1) For key to numbers, see pages 3/38 and 3/39 of this catalog.

(2) Normal environment:

- without special environmental restrictions,
- operating temperature between + 5 °C and + 60 °C,
- fixed installations.

(3) Harsh environment:

- resistance to hydrocarbons, industrial oils, detergents, solder splashes,
- up to 100 % humidity,
- saline environment,
- significant variations in temperature,
- operating temperature between - 10 °C and + 70 °C,
- mobile installations,
- Use in garland: radius of curvature = 10 x cable diameter (either 80 or 95 mm).

For other special restrictions, please consult your Regional Sales Office.

# Modicon® Premium™ automation platform

## TeSys® Quickfit for motor starter components Components with spring terminals

3

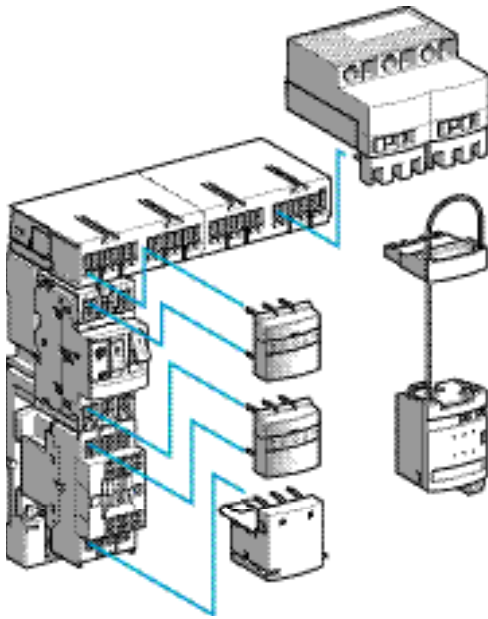

Motor starter with GV2 ME circuit-breakers

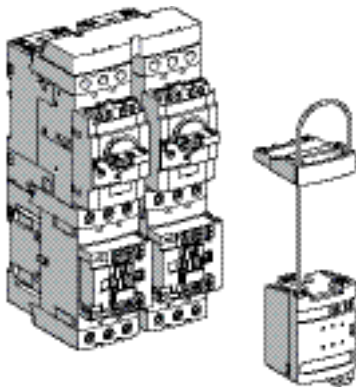

Motor starter with GV3 P circuit-breakers

TeSys® Quickfit is a modular system which standardizes and simplifies the set up of motor starters by utilizing its pre-wired control and power circuits.

Installation of a motor starter is quick, simple and flexible. In addition, this system:

- enables the motor starter to be customized at a later date,
- reduces maintenance time and
- optimizes panel space by reducing the number of terminals and intermediate interfaces and the amount of ducting.

### System for motor starters with spring terminals

#### Motor starters with TeSys® GV2 ME circuit-breakers

- From 0 to 18 A max.,
- TeSys GV2 ME circuit-breakers combined with LC1 D contactors from 9 to 25 A (spring terminal version),
- Quickfit pre-wired power and control connections.

#### Motor starters with TeSys® GV3 P circuit-breakers

- From 9 to 65 A max.,
- TeSys GV3 P circuit-breakers combined with LC1 D contactors from 40 to 65 A (spring terminal version),
- Quickfit pre-wired control connections only,
- For pre-wired power connections, use busbar sets from the TeSys d 40 to 65 A contactor range (see page 24511/9).

This range is comprised of pre-wiring components for:

- the power circuits,
- the control circuits.

#### Power circuit pre-wiring components

(motor starters with TeSys GV2 circuit-breakers only)

- a **power circuit connection kit** comprising, for each starter, a plate for mounting the contactor and the circuit-breaker and two power connection modules,
- a **power splitter box** for 2 or 4 starters,
- an **upstream terminal block** for a power supply up to 60 A (16 mm<sup>2</sup>),
- an **outgoing terminal block** for connection of the motor power supply cables and the ground cables (6 mm<sup>2</sup>).

**Note:** with GV3 circuit-breakers, no accessories are required for pre-wiring of the power circuit. The GV3 P●● outgoing terminal block can be removed.

This circuit-breaker is also sold with only one terminal block (reference: GV3 P●●1).

#### Control circuit pre-wiring components

(motor starters with TeSys GV2 and GV3 circuit-breakers)

- a **control circuit connection module** which plugs directly into the contactor and the circuit-breaker on each starter. This module incorporates status and control data for this motor starter.
- a **parallel wiring module** which concentrates the data of each motor starter:
  - **HE 10** connector, for centralized applications. Data is transmitted to the PLC via the Advantys Telefast pre-wired system.
  - **STB**, designed for decentralized automation architectures. This module is suitable for use in an Advantys STB configuration for connection to the PLC via a field bus.

# Modicon® Premium™ automation platform

TeSys® Quickfit for motor starter components  
Components with spring terminals

## Control/command

### HE 10 connection

- 1 Automation platform
- 2 Connection cable  
TSXCDP●● or ABFH20●●
- 3 Splitter box LU9 G02

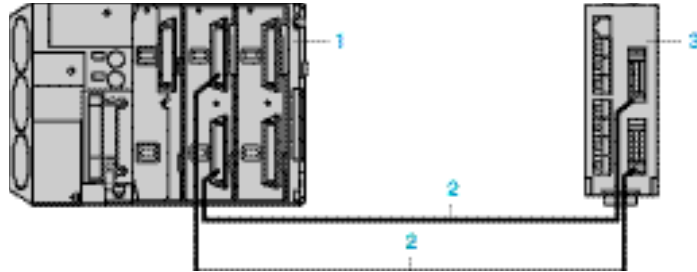

### Connection on bus using Advantys™ STB (1)

Configuration example (for motor starter applications only):

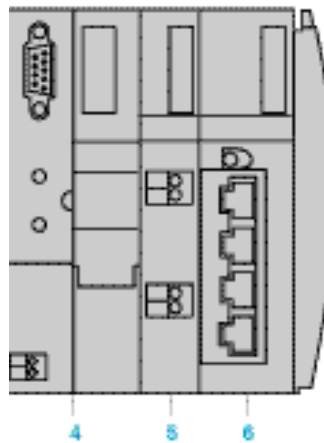

- 4 Network interface module
- 5 Supply module
- 6 Parallel interface module

#### Power supply module

Module	STB PDT 3100
Connection base	STB XBA 2200
Terminal block	STB XTB 1130

#### Parallel interface module (2)

Module	STB EPI 2145
Connection base	STB XBA 3000

#### Network interface module (3)

CANopen	STB NCO 1010 (4)
Fipio®	STB NFP 2210
Ethernet TCP/IP	STB NIP 2210
InterBus®	STB NIB 1010 (4)
Profibus DP™	STB NDP 1010 (4)
DeviceNet®	STB NDN 1010 (4)
Modbus Plus™	STB NMP 2210
Terminal block	STB WTS 2120

### TeSys® Quickfit LAD 9AP3 ●● used with modules APP1 C●●

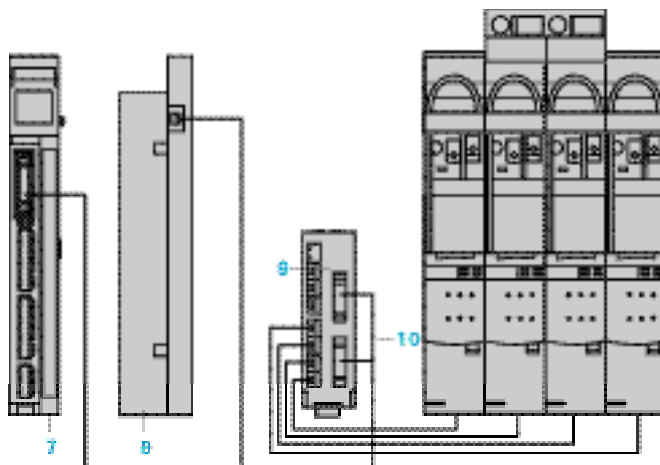

- 7 TeSys® Quickfit module
- 8 Adapter plate APP 2CX
- 9 Splitter box LU9 G02 for 8 direct motor starters, with channel connections on the APP 1C module side by two HE 10 connectors (20-way) and on the TeSys Quickfit side, by RJ45 connectors
- 10 Connection cable APP 2AH40H060

The motor starter is connected to an APP 1C● module 7 using an adapter plate APP 2CX 8 and a connection cable APP 2AH40H060 10.

Information is available on the module for each motor starter:

- 1 output: motor control,
- 2 inputs: circuit-breaker status and contactor status.

(1) Please consult our catalog "Advantys STB I/O. The open solution".

(2) For 4 direct or 2 reversing motor starters.

(3) Reference to be selected according to the network used.

(4) Optimized version.

**TeSys® Quickfit, compatibility with PLC inputs/outputs and distributed inputs/outputs**

Automation platforms	Splitter box	Parallel interface module Advantys™ STB
----------------------	--------------	---



3

Type	Modularity of connection to the PLC	Compatible I/O modules	Splitter	Module
			<ul style="list-style-type: none"> <li>- for 8 motor starters TeSys® U (16 PLC inputs and 8 PLC outputs)</li> <li>- 8 RJ45 connectors, motor starters side</li> <li>- 2 HE 10 connectors, PLC side</li> </ul>	<ul style="list-style-type: none"> <li>- for 4 motor starters TeSys® U</li> <li>- 4 x RJ45 connectors, motor starters side</li> </ul>
			LU9 G02	STB EPI 2145



<b>Modicon® TSX Micro™ platform</b>			
16 inputs + 12 outputs	TSX™ DMZ 28DTK	Max. 8 motor starters: 1 splitter	
2 x 16 inputs + 2 x 16 outputs	TSX DMZ 64DTK	Max. 16 motor starters: 2 splitters	
<b>Modicon® Premium™ platform</b>			
16 inputs + 12 outputs	TSX™ DMY 28FK	Max. 8 motor starters: 1 splitter	
2 x 16 inputs + 2 x 16 outputs	TSX™ DEY 32D2K TSX™ DSY 32T2K	Max. 16 motor starters: 2 splitters	
4 x 16 inputs + 2 x 16 outputs	TSX DEY 64D2K TSX DSY 32T2K	3Max. 32 motor starters: 4 splitters	
<b>Modicon® Quantum™ platform</b>			
2 x 16 inputs + 2 x 16 outputs	140 DDI 353 00, 140 DDI 853 00 140 DD0 353 10	Max. 16 motor starters: 2 splitters	
6 x 16 inputs + 6 x 16 outputs	140 DDI 364 00 140 DD0 364 00	Max. 48 motor starters: 6 splitters	
<b>Advantys™ STB distributed inputs/outputs</b>			
16 inputs + 8 outputs	STB EPI 1145		Max. 4 motor starters: 1 parallel interface module



## TeSys® Quickfit, compatibility with PLC inputs/outputs and distributed inputs/outputs (continued)

### Connection accessories

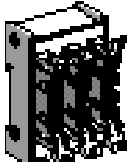

<b>Splitter box 16 to 2 x 8</b> - 3 HE 10 connectors	<b>Cordsets</b> - with 2 HE 10 connectors - AWG 22, 0.324 mm <sup>2</sup> - 5 lengths 0.5, 1, 2, 3, 5 or 10 m	<b>Cordsets</b> - with 2 HE 10 connectors - AWG 28, 0.080 mm <sup>2</sup> - 3 lengths 1, 2 or 3 m	<b>Cabled connectors</b> - terminal block with 2 cordsets equipped to HE 10 connectors - AWG 22, 0.324 mm <sup>2</sup> - 2 lengths 1.5 or 3 m	<b>Cordsets</b> - with 2 RJ45 connectors - 3 lengths 0.3, 1 or 3 m
<b>ABE 7ACC 02</b>	<b>TSX CDP ●●3 (1)</b>	<b>ABF H20 H●●0 (2)</b>	<b>ABF M32 H●●0 (3)</b>	<b>LU9 R●● (4)</b>

<b>Modicon® TSX Micro™ platform</b>				
	2 cordsets			
1 splitter (rest 16 PLC outputs)	5 cordsets			
<b>Modicon® Premium™ platform</b>				
	2 cordsets			
1 splitter (rest 16 PLC outputs)	5 cordsets			
2 splitters	10 cordsets			
<b>Modicon® Quantum™ platform</b>				
3 splitters (rest 16 PLC outputs)			2 cabled connectors	
3 splitters (rest 48 PLC outputs)	15 cordsets			
<b>Advantys™ STB distributed inputs/outputs</b>				
				4 cordsets

(1) Replace ●● by 05: length 0.5 m, 10: length 1 m, 20: length 2 m, 30: length 3 m, 50: length 5 m, 100: length 10 m.

(2) Replace ●● by 10: length 1 m, 20: length 2 m, 30: length 3 m.

(3) Replace ●● by 15: length 1.5 m, 30: length 3 m.

(4) Replace ●● by 03: length 0.3 m, 10: length 1 m, 30: length 3 m.



## 4.1 - Preventa™ machine safety modules and solutions

- Use of Preventa machine safety modules ..... 4/2
- Preventa machine safety modules ..... 4/4
- Preventa configurable safety controllers ..... 4/10

## 4.2 - Application-specific counter modules

- Selection guide: Counter and electronic cam modules ..... 4/18
- 40 kHz counter modules ..... 4/20
- 1 MHz measurement and counter module ..... 4/24
- Electronic cam module ..... 4/28

## 4.3 - Motion control modules

- Selection guide: motion control modules ..... 4/32
- Modules for stepper motors ..... 4/34
- Modules for servo motors ..... 4/38
- SERCOS™ motion control modules ..... 4/46

## 4.4 - Integrated weighing system

- ISP Plus weighing modules
  - Presentation ..... 4/54
  - Description ..... 4/55
  - Functions ..... 4/56
  - Characteristics ..... 4/57
  - References ..... 4/58

## 4.5 - Redundancy solutions

- Hot standby system (Unity™ Pro)
  - Presentation ..... 4/60
  - Description ..... 4/61
  - Architectures and connections ..... 4/62
  - Functions ..... 4/66
  - Dimensions ..... 4/67
  - Characteristics ..... 4/68
  - References ..... 4/69
- Warm Standby redundancy (PL7™ Pro)
  - Presentation/principle ..... 4/70
  - Functions ..... 4/72
  - References ..... 4/74
  - Connections ..... 4/75



### Machine safety

Production workshops and technical building installations are subject to increasing requirements for machine safety.

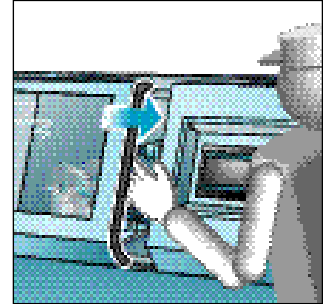
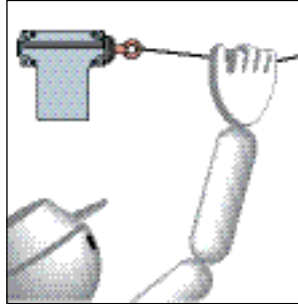
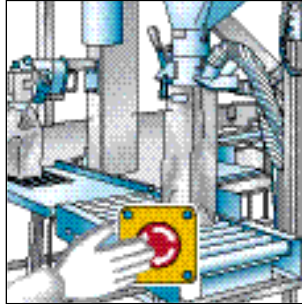

A good machine design combines the following

- Protection of personnel.
- Availability of the production tool.
- Good machine design is achieved by:
  - optimizing personnel protection and machine availability,
  - using basic principles: redundancy, self-monitoring, etc,
  - considering reliability (determine correct machine behavior in the event of communication loss or other unplanned events),
  - ease of maintenance.

4

### The machinery directive and the work equipment directive

#### The machinery directive

A machine manufacturer is required to conform to the machinery directive

The machinery directive (89/392/EEC, 91/36/EEC, 93/44/EEC and 93/68/EEC) is designed to help ensure the free circulation of machinery and safety components in European Union countries and to improve the level of protection for personnel.

Harmonized European standards establish technical specifications which comply with the minimum safety requirements defined in the corresponding directive.

Manufacturers must produce machinery which conforms to safety requirements.

#### The work equipment directive

The user is required to ensure that his range of machines conforms to the use of work equipment by workers at work directive

Directive 89/655/EEC lays down the minimum objectives for protection in the working environment and in particular concerns the use of products. The directive specifies the general framework of preventative measures which should be taken in the workplace.

### Machine safety and automated systems

Hazardous areas must be identified and have restricted access, and be controlled in a secure manner.

It should be noted that the use of safety products does not necessarily mean that the machine conforms to the machinery directive.

It is the operation, wiring, compatibility and scheme used, that enable the machine to meet the required standards. It is more important to think in terms of safety solutions rather than safety products.

### Schneider Electric - a machine safety specialist

Schneider Electric, a specialist in machine safety applications and products, has a range of several thousand products, some of which are designed specifically to address machine safety requirements.

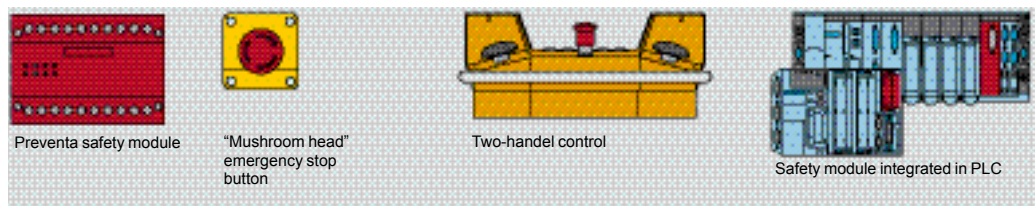

For further details on components for safety applications, please consult our catalog: "Preventa™ Machine Safety Products 2009".



### Non-controlled safety systems

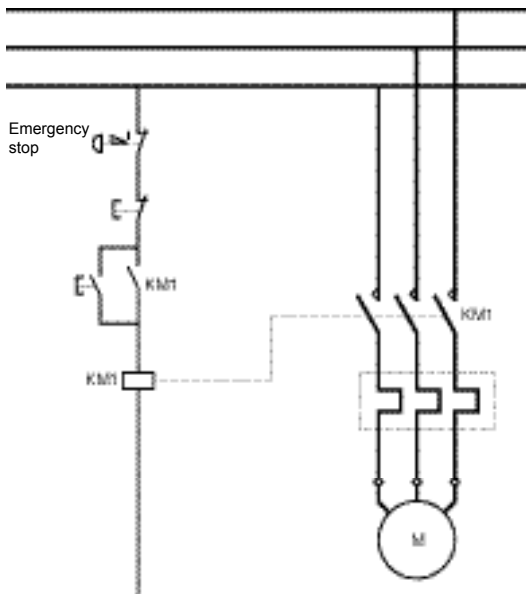

The control signal from the protection device (emergency stop pushbutton illustrated to the left) acts directly on the power contactor of the machine.

In this type of scheme, the risks of simple detected faults are:

- Emergency stop button being shorted.
- KM1 contactor sticking.

When the operator presses an emergency stop button, the instruction is not processed, and another sequence can begin following the emergency stop, despite the presence of the detected fault.

In the case of detected failure, the safety function (1) is compromised. Therefore, a reliable intermediate relay system must be used.

(1) A safety function is a function whose non-execution or untimely execution results in the immediate placement of the equipment into a non-hazardous position.

### Safety system controlled by a Preventa™ safety module

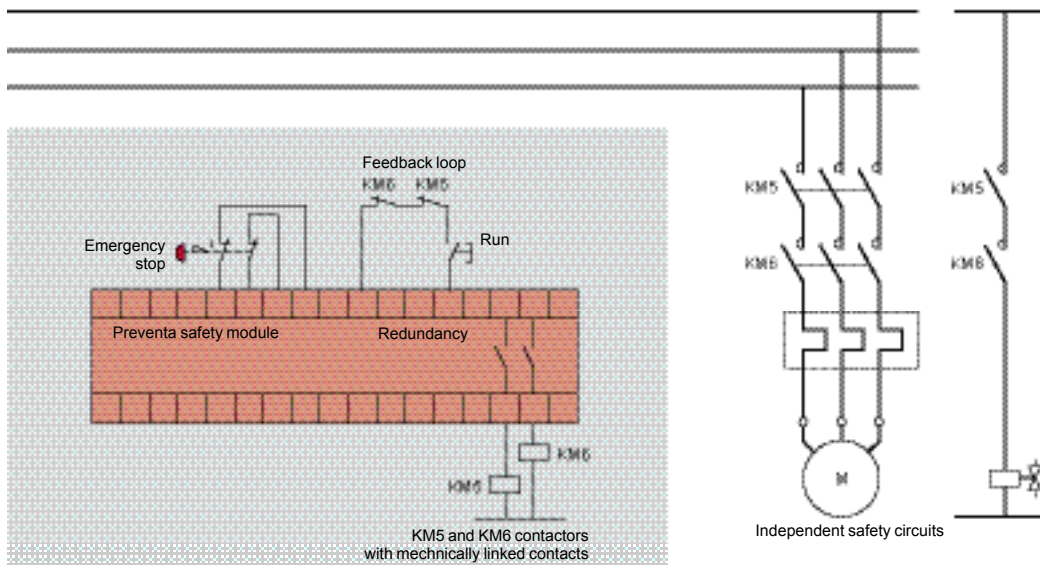

Preventa safety modules provide a reliable interposing relay function by helping to eliminate the risks of:

- An inoperative control circuit (inputs).
- An inoperative power circuit (outputs).
- An inoperative internal component on a safety module.

The safety function remains operative whenever any one of these situations occur.

Note: For the use of mechanically linked contacts CA2-KN22/KN31, LC1-D09/D18/D25 with contacts which can be used in the feedback loop, please consult your Regional Sales Office

## Presentation

TSX™ PAY safety modules integrated in the Modicon® Premium™ PLC combine :

- the simplicity of use of Preventa™ machine safety modules
  - the high performance of PLC diagnostics
- in addition to the advantages of a standard PLC (extended choice of I/O, simplicity of setup, flexibility for hardware and software developments, etc).

TSX PAY safety modules incorporate in a single module, a Preventa (XPS) hard-wired safety block and an electronic data acquisition unit for complete diagnostics of input contacts and the state of outputs in the safety system.

TSX PAY safety modules are used to interrupt one or more Emergency stop or safety stop control circuits according to the standards IEC/EN 60204-1 and EN/ISO 13850.

The proven performance of hard-wired technology and the performance of Premium™ PLCs make the TSX™ PAY modules the optimum solution for creating machines which are more available, more compact and lower in cost.

## Solution for applications requiring safety systems and high-performance diagnostics

The solution, integrated safety modules, enables complete diagnostics on the entire safety system. This diagnostics quickly locates the inoperative contact, pushbutton cables, or limit switch, without additional contacts on the inputs and without any additional wiring.

TSX PAY safety modules have their own power supplies and operate independently of the PLC processor.

TSX PAY modules are suitable for Emergency stop and limit switch monitoring applications, demanding up to a category 4 rating according to standard EN 954-1/ISO 13849-1 (parts of control systems relating to safety).

## Functions

TSX PAY modules offer the following functions:

- Monitoring of 1 to 12 double or single pushbutton contacts, Emergency stop and limit switches for safety guards for an Emergency stop or immediate stop safety system (Emergency stop category 0 according to standard EN/ISO 13850).
- Hard-wired safety block identical to Preventa XPS safety modules:
  - 2 or 4 N/O (normally open) safety outputs,
  - 12 double contact inputs.
- Safety block independent of the Premium PLC processor: the PLC does not operate on the safety module.
- 28 LEDs on the module display block: for complete diagnostics of the safety system.
- Electronic data acquisition units for complete diagnostics of the safety system:
  - read the status of the 24 inputs (image of the status of the 12 pushbuttons or limit switches)
  - read the enable input,
  - read the feedback loop,
  - read the safety outputs control,
  - monitor the external power supply of the module.

This electronic data acquisition is designed so that the safety function is not compromised by detected failure. If the safety system uses more sensors, it is possible to connect several TSX PAY modules.

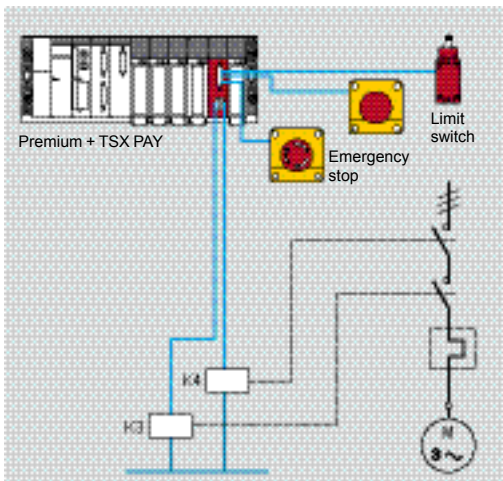

### TSX™ PAY 262 module schematic

To help ensure the safety function regardless of the first detected failure, it is compulsory to use:

- For the inputs: Emergency stop pushbuttons or safety limit switches with double contacts
- For the outputs: if relaying is necessary, use a guided contact relay
- On the module power supply : an F1 protection fuse (see characteristics page 4/7)

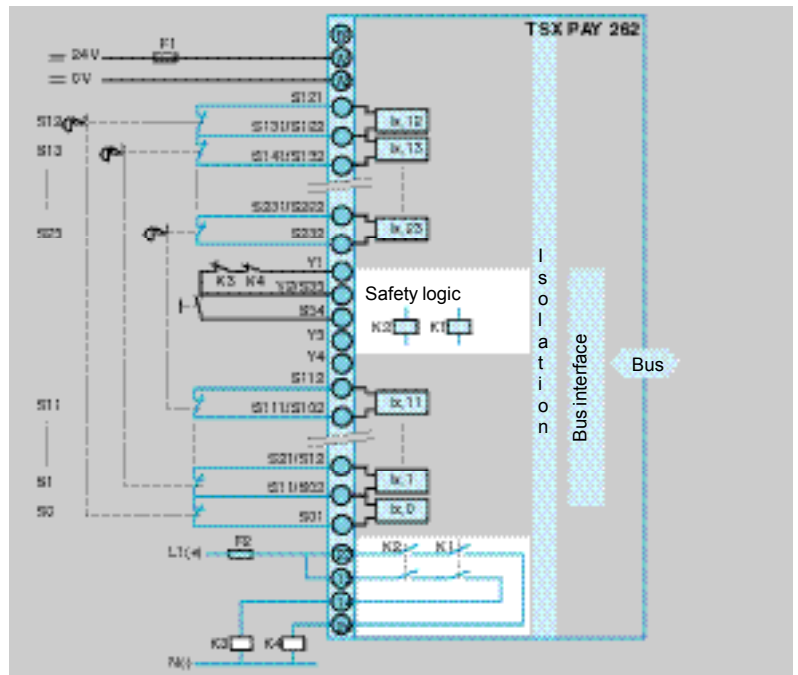

- 13-14 and 23-24 Safety outputs, volt-free
- Y1-Y2/S33: Feedback loop
- Y2/S33-S34: Run enable
- Y3-Y4: Choice of reactivation mode, see page 4/9
- S121 to S232: 12 contacts on (+) input channel
- S01 to S112: 12 contacts on (+) input channel
- A1-A2: 24 V external power supply
- B1: Selection of double or single contact wiring

### Functional diagrams

#### Emergency stop function

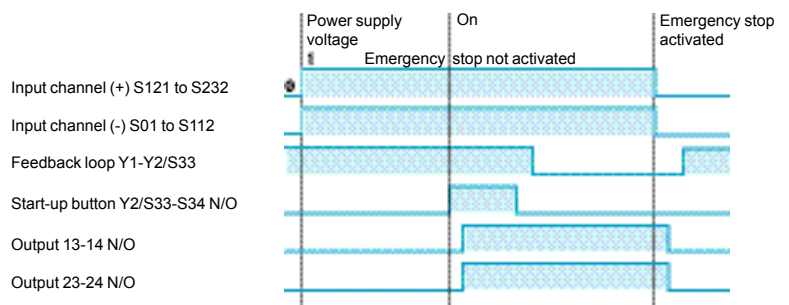

#### Protective function with automatic start-up

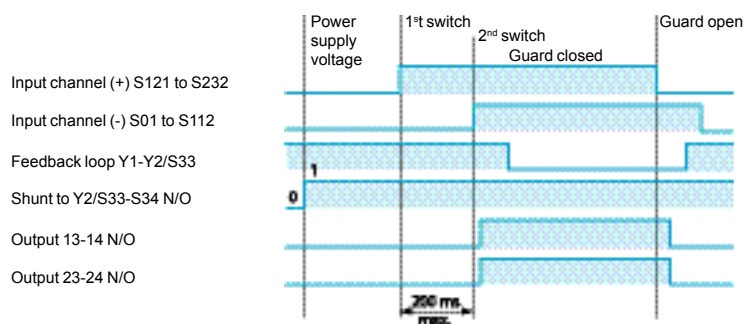

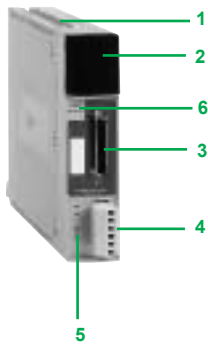

## Description

TSX™ PAY safety modules feature the following on the front panel :

- 1 Rigid IP 20 casing to hold and protect the electronic card.
- 2 Display block (32 LEDs) showing operating modes, and the status of the safety system.
- 3 High density 44-way SUB-D connector for connecting the safety system.
- 4 6-way removable screw terminal block for connecting the safety outputs.
- 5 Marking for labeling the safety outputs.
- 6 Marking for the external power supply of the module.

4

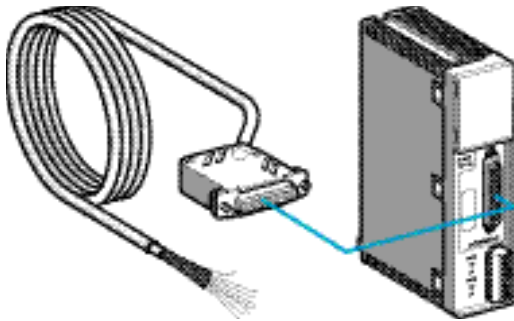

## Connection principle

Two types of connection for TSX PAY safety modules are available:

### Standard wiring

A **TSX™ CPP 301** 3 m cordset is fitted with a 44-way SUB-D moulded, elbow connector at one end, and flying leads differentiated by a color code at the other end.

This wiring system conforms to the standard EN 954-1/ISO 13849-1.

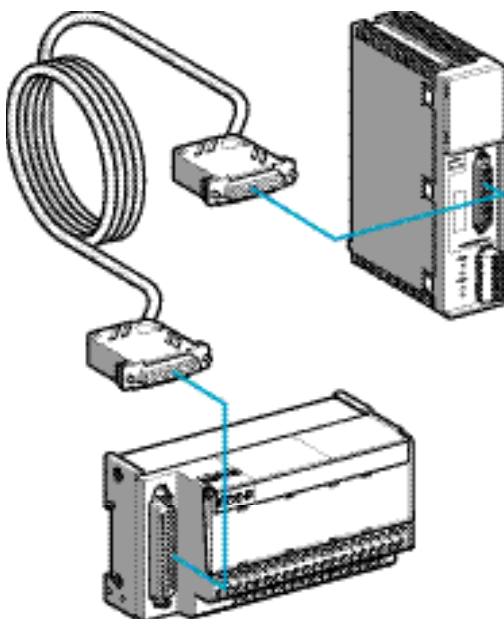

### Fast wiring

Using the Advantys™ Telefast® ABE 7 pre-wired system facilitates the installation of TSX PAY safety modules by giving access to inputs on the safety system via screw terminals.

Connection is carried out using **TSX CPP ●02** cordsets fitted with 44-way SUB-D moulded, elbow connectors at both ends.

The Advantys Telefast **ABE 7CPA13** sub-base enables the connection of 12 double or single contact inputs, the power supply, reset inputs and the feedback loop.

This wiring system conforms to the standard EN 954-1/ISO 13849-1.

**Standards and certifications**

Type of modules			TSX™ PAY 262	TSX PAY 282
Standards	Machine	Machine electrical equipment	IEC/EN 60204-1, EN/ISO 12100	
		Emergency stop equipment	EN/ISO 13850	
	Product	Machine safety-parts of control systems relating to safety	EN 954-/ISO 13849-11 category 4, EN 1088/ISO 14119	
	PLC	Specific requirements	IEC/EN 61131-2, CSA 22-2, UL 508	
Product certifications			BG, UL, CSA	

**General characteristics**

Power supply	Nominal voltage	V	--- 24
	Operating voltage limit	V	--- 19,2...30
	Status indication	V	--- < 20
	Maximum consumption	mA	200
Protection by external F1 fuse	Conforming to IEC/EN 947-5-1	A	1 gG
Consumptions		mA	See page 9/6
Isolation		kV	4 (overvoltage category III, degree of pollution 2)

**Characteristics of discrete inputs**

Modularity	Discrete inputs		12 double or single contacts for Emergency stop or limit switch			
	Reset PB input		1			
	Feedback loop input		1			
	Reset PB monitoring input		1			
	Double or single contact selection input		1			
Logic			Positive			
IEC/EN 61131 conformity			Type 1			
Inrush current	Maximum	A	0,5			
Isolation between input and ground			V rms	500 - 50/60 Hz for 1 min		
Power	Dissipated in the module	W	< 5			

**Characteristics of safety relay outputs**

Modularity			2 volt-free outputs		4 volt-free outputs		
Operating voltage limit	a.c	V	~ 19...250				
	d.c	V	--- 17...127				
Maximum thermal current (I <sub>the</sub> )			A	2,5			
Minimum current			mA	30			
a.c. load	Inductive AC-15 duty	Voltage	V	~ 24	~ 48	~ 110	~ 220
		Power	VA	60	120	280	550
d.c. load	Inductive DC-13 duty (L/R = 100 ms)	Voltage	V	--- 24			
		Power	VA	60			
Response time			ms	< 10			
Type of contact			AgCdO gold plated				
External protection of outputs by F2 fuse			A	4 gG, conforming to IEC/EN 60947-5-1			
Cross-section of connecting cables	Without cable end	mm²	0.2...2.5				
	With cable end	mm²	1,5				
Isolation between input and ground	Insulation voltage	V	300, conforming to DIN VDE 0110 part 2				
	Test voltage	V rms	1500 - 50/60 Hz for 1 min				

# Modicon® Premium™ automation platform

## Preventa™ machine safety modules type TSX™ PAY



TSX PAY 262



TSX PAY 282

### Safety modules

Type of input $\bar{c}$ 24 V	Safety outputs	Connections	Reference	Weight kg
12 Emergency stops or limit switches (double or single contacts), 1 reset button, 1 feedback loop, 1 reset monitor	2 N/O (volt-free) 2.5 A (lthe)	Inputs: 44-way SUB-D connector Outputs: screw terminal (supplied)	<b>TSX™ PAY 262</b>	0.430
	4 N/O (volt-free) 2.5 A (lthe)	Inputs: 44-way SUB-D connector Outputs: screw terminal (supplied)	<b>TSX PAY 282</b>	0.490

### Connection accessory

Description	For connection on screw terminal	Type of connector on TSX PAY 2•2	Reference	Weight kg
<b>Advantys™ Telefast® ABE 7 sub-base</b> for TSX PAY 2•2 modules	Safety system, reset, monitoring and loop inputs Power supply $\bar{c}$ 24 V	SUB-D, 44-way	<b>ABE 7CPA13</b>	0.290



ABE-7CPA13

### Connecting cordsets

Use	From TSX PAY 2•2 module	To	Length	Reference	Weight kg
For fast wiring	44-way SUB-D connector	ABE-7CPA13 sub-base	1 m	<b>TSX™ CPP 102</b>	0.160
			2 m	<b>TSX CPP 202</b>	0.260
			3 m	<b>TSX CPP 302</b>	0.360
For standard wiring	44-way SUB-D connector	Flying leads with color-coded wires	3 m	<b>TSX CPP 301</b>	0.330



TSX CPP 102



TSX CPP 301

**Input channel connection schemes**

Wiring 1 input channel: single contact

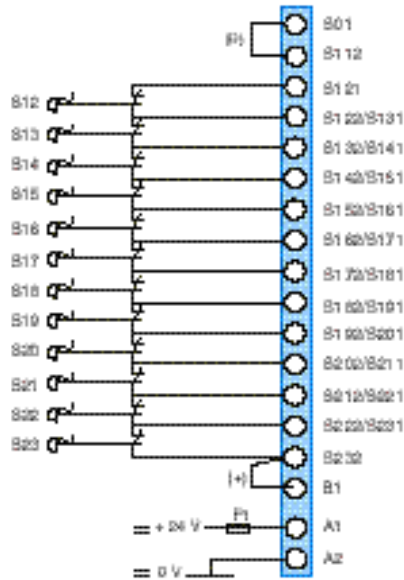

Single contact wiring is not suitable for applications which require a category 3 or 4 safety level. A short-circuit on a contact is not detected.

When using less than 12 single contacts, connect the input terminals which are not being used.

For applications with more than 12 single contacts, it is possible to use several TSX PAY modules by wiring the outputs in series.

Double contact wiring of the inputs is necessary for creating applications which require a category 3 or 4 safety level. When prompted, the first faults are detected and located. A short-circuit between the 2 inputs is detected.

When using less than 12 double contacts, connect the input terminals which are not being used.

For applications with more than 12 double contacts, it is possible to use several TSX PAY modules by wiring the outputs in series.

Wiring 2 input channels: double contacts

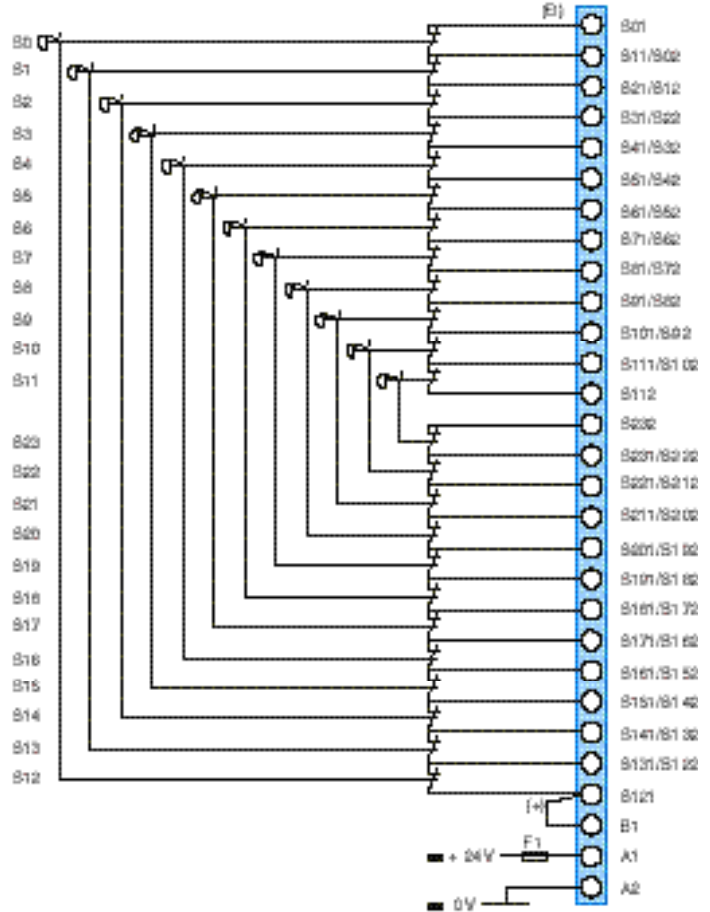

**Safety output connection schemes**

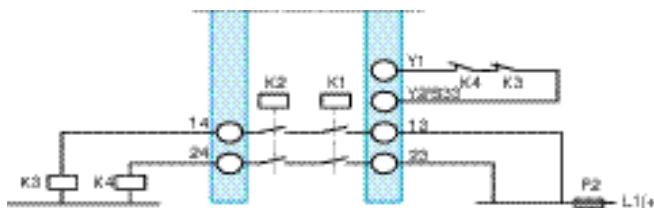

**Reset function configurations**

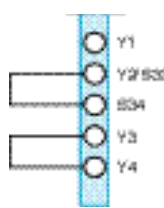

Automatic start-up

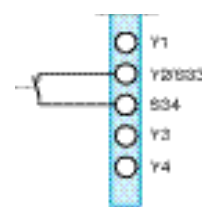

Manual reset without start button monitoring

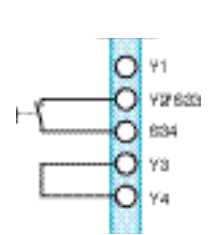
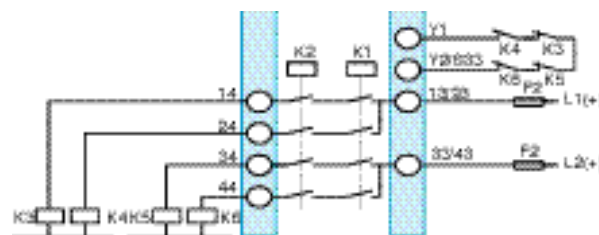

Manual reset with start button monitoring

The design of a category 3 or 4 immediate stop system requires redundancy and checking, on request, of the power supply breaker devices.

The wiring of N/C contacts (K3 and K4) enables this check on each request. Relays K3 and K4 must be mechanically linked contact relays.

When TSX PAY modules cut the power directly, it is necessary to connect the terminals Y1 and Y2/S33.



# Modicon® Premium™ automation platform

## Preventa™ configurable safety controllers type XPS MC

### Presentation

Configurable safety controllers XPS MC●●Z● are designed to provide a solution for safety applications requiring conformity to category 4 of standard EN 954-1/EN/ISO 13849-1 and SIL 3 requirements of standard IEC 61508. This range of configurable controllers is comprised of 6 products, each with different technical characteristics.

Configurable controllers	Inputs	Outputs (1)	Communication via		
			CANopen bus	Profibus™ bus	Modbus® serial link
XPS MC16Z	16	6 + 2 x 2	–	–	Yes, slave
XPS MC16ZC	16	6 + 2 x 2	Yes, slave	–	Yes, slave
XPS MC16ZP	16	6 + 2 x 2	–	Yes, slave	Yes, slave
XPS MC32Z	32	6 + 2 x 2	–	–	Yes, slave
XPS MC32ZC	32	6 + 2 x 2	Yes, slave	–	Yes, slave
XPS MC32ZP	32	6 + 2 x 2	–	Yes, slave	Yes, slave

### Line control

The safety inputs are supplied by the various control outputs (2), in such a manner so as to monitor for short-circuits between the inputs, short-circuits between each input and ground, or the presence of residual voltages. The controller, assisted by the control outputs, continuously tests the connected inputs. As soon as an error is detected on an input, the outputs associated with this input are disconnected. Safety outputs associated with other inputs remain active.

### Configuration

Safety controllers XPS MC●●Z● are configurable and addressable using software XPS MCWIN running on a PC. Connection accessories required: see page 4/17 of this catalog.

### Connections

For connection of safety inputs and outputs, safety controllers XPS MC●●Z● can be fitted with a choice of:

- screw connectors type XPS MCTS●●, or
- spring clip connectors type XPS MCTC●●.

These connectors are to be ordered separately, see page 4/17 of this catalog.

(1) 8 independent safety outputs = 6 solid-state safety outputs + 2 x 2 relay outputs (4 relay outputs with guided contacts).

(2) 8 control outputs are available but they are not safety outputs.



XPS MC16ZC



XPS MC32ZC



# Modicon® Premium™ automation platform

## Preventa™ configurable safety controllers type XPS MC

### Safety functions

Configuration of the safety functions is carried out using software XPSMCWIN which is available on the Safety Suite V2 CD-ROM.

30 certified functions are available with this software and they are easily assignable to the safety outputs. These safety functions have multiple combination possibilities and various starting conditions.

The functions are:

- certified in accordance with EN 954-1/EN/ISO 13849-1 and IEC 61508,
- configurable in controller XPS MC using software XPSMCWIN which is available on the Safety Suite V2 software pack.

The 8 safety outputs are suitable for use in related parts of control systems conforming to category 4 of EN 954-1/EN/ISO 13849-1 and each output can disconnect one of its safety circuits.

### Main safety functions

- Emergency stop monitoring, with or without time delay, 1 or 2-channel wiring
- Two-hand control (type III-C conforming to EN 574/ISO 13851)
- Guard monitoring with 1 or 2 limit switches
- Guard monitoring for injection presses and blowing machines
- Magnetic switch monitoring
- Sensing mat monitoring
- Light curtain (type 4 conforming to EN/IEC 61496, relay or solid-state output) monitoring
- Zero speed detection
- Dynamic monitoring of hydraulic valves on linear presses
- Monitoring safety stop at top dead center on eccentric press
- Safety time delays
- "Muting" function of light curtains
- Enabling switch monitoring, 2 or 3 contact
- Hydraulic press
- Eccentric press
- Foot switch monitoring
- Chain shaft breakage monitoring
- Position selector

### Application schemes and functional diagrams

Consult our catalog "Preventa™ Machine Safety Products 2009"

# Modicon® Premium™ automation platform

## Preventa™ configurable safety controllers type XPS MC

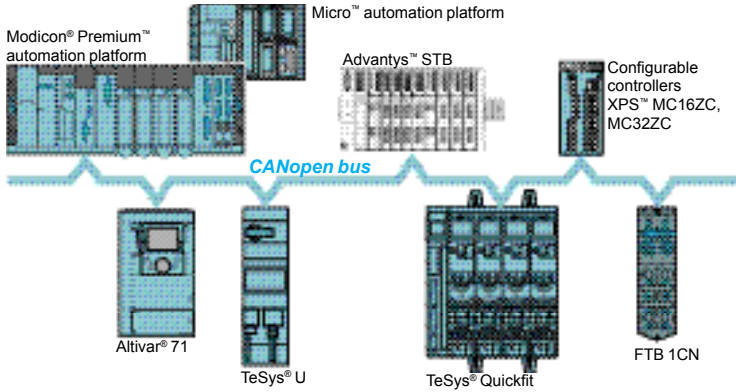

### Communication

#### CANopen fieldbus

Configurable safety controllers XPS MC●●ZC incorporate a SUB-D 9-pin male connector for direct connection on CANopen bus.

CANopen bus is an open bus that provides deterministic and reliable access to the real-time data of automation equipment. The bus uses a shielded dual twisted pair on which a maximum of 127 devices can be connected by chaining. The data rate varies between 10 Kbps and 1Mbps depending on the length of the bus (5000 m to 20 m).

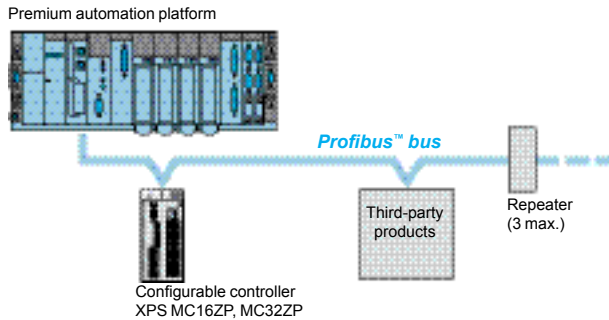

#### Profibus™ bus

Configurable safety controllers XPS MC●●ZP incorporate a SUB-D 9-pin female connector for connection on Profibus™ bus.

Configurable safety controllers XPS MC●●ZP are slaves on the Profibus bus.

Profibus bus is a fieldbus that meets industrial communication requirements. The topology of the Profibus bus is of the linear type with a centralized master/slave type access procedure. The physical link is a single shielded twisted pair.

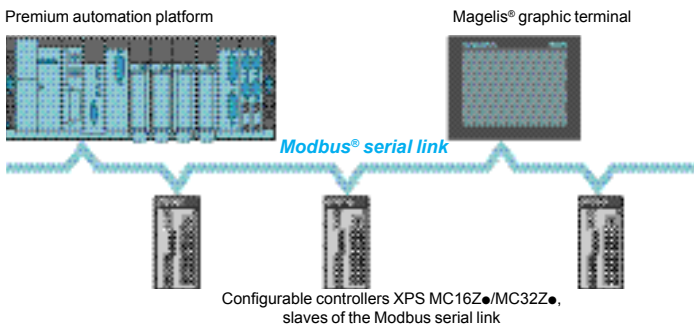

#### Modbus® serial link

Configurable safety controllers XPS MC●●Z● MC incorporate a Modbus® communication interface (RJ45 connector) for configuration and diagnostics.

This interface enables connection of the controllers to:

- a PC (configuration),
- a PLC (diagnostics), or
- an operator dialog terminal (diagnostics).

The Modbus serial link is comprised of a master station (Modicon® Premium™ automation platform) and slave stations (configurable controllers XPS MC16/32Z●).

Two exchange mechanisms are possible:

- **Question/response:** the questions from the master are addressed to a given slave. The response is expected by return from the interrogated slave.
- **Distribution:** the master distributes a message to all the stations of the Modbus serial link. The latter execute the order without transmitting a reply.

# Modicon® Premium™ automation platform

## Preventa™ configurable safety controllers type XPS MC

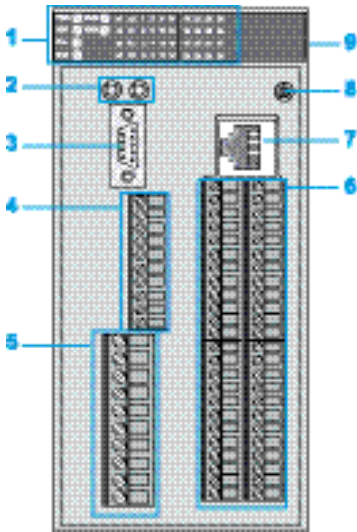

Configurable safety controller XPS MC●●Z●, with screw connectors

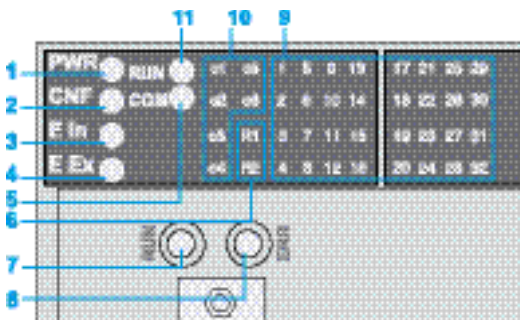

Illuminated display

### Description

#### Configurable safety controllers XPS MC●●Z●

##### Front face of controllers:

- 1 LED display and system diagnostics.
- 2 Two LEDs for CANopen or Profibus™ (1) connection status.
- 3 SUB-D 9-pin male connector for connection on CANopen bus (XPS MC16ZC/MC32ZC) or SUB-D 9-pin female connector for connection on Profibus bus (XPS MC16ZP/MC32ZP).
- 4 Solid-state safety output and “muting” indicator light terminals.
- 5 Power supply (— 24 V) and relay safety output terminals.
- 6 Control output terminals for power supply to safety inputs and safety input terminals.
- 7 RJ45 connector for connection on Modbus serial link.
- 8 RESET button (resetting of controller).

##### Rear face of controllers:

- 9 Fixing plate for mounting on rail.

(1) Depending on controller model.

#### LED details

LED	Color	Status	Meaning
1 PWR	Green	On	Supply voltage present.
2 CNF	Yellow	On	In configuration mode.
		Flashing	Not configured, initial power-up.
3 E In	Red	On	Internal detected error: safety outputs deactivated.
		Flashing	External detected error: safety outputs associated with the circuit are deactivated.
4 E Ex	Red	On	External detected error: safety outputs associated with the circuit are deactivated.
		Flashing	Controller communicating via the TER (RJ45) connection.
5 COM	Green	On	Relay outputs 13/14, 23/24, 33/34 and 43/44 activated.
		Flashing	Detected fault on these outputs.
7 RUN	Green	Off	Hardware OK for the Profibus bus or the CANopen bus.
		On	Communicating on Profibus bus or on CANopen bus.
		On	Normal status.
		On	Communication impossible, incorrect configuration, damaged cabling or absence. Bus deactivated
		Off	Communicating on CANopen or Profibus bus. Normal status.
8 ERR	Red	On	Warning limit reach.
		Flashing (x 1)	Detected control event error on CANopen bus.
		Flashing (x 2)	Synchronization error on CANopen bus.
		Flashing (x 3)	Input circuit closed.
9 1...16 1...32	Green	On	Error detected on input relating to LED.
		Flashing	Solid-state output activated.
10 o1...o6	Green	On	Short-circuit, detected fault on output.
		Flashing	Run mode.
11 RUN	Green	On	Changing from run mode to stop mode.
		Flashing	

# Modicon® Premium™ automation platform

Preventa™ configurable safety controllers  
type XPS MC

4

Characteristics			XPS MC16Z and MC32Z, XPS MC16ZC and MC32ZC, XPS MC16ZP and MC32ZP	
Configurable safety controller type			XPS MC16Z and MC32Z, XPS MC16ZC and MC32ZC, XPS MC16ZP and MC32ZP	
Conformity to standards			EN/IEC 60204-1, EN 1760-1/ISO 13856-1, EN/IEC 60947-5-1, EN/IEC 61496-1, EN 574/ISO 13851, EN 954-1/EN/ISO 13849-1, IEC 61508	
Product certifications			UL, CSA, TÜV	
Products designed for max. use in safety related parts of control systems (conforming to EN 954-1/EN/ISO 13849-1 and IEC 61508)			Category 4 max. (EN 954-1/EN/ISO 13849-1), SIL 3 max. (IEC 61508)	
Supply voltage	V		~ 24 ± 20%	
Maximum consumption	W		12	
Fuse protection	A		16 gL max.	
Start button monitoring			Configurable	
Control circuit voltage			28.8 V/13 mA (between input terminals C1-I1 to C8-I16, resp. I32)	
Calculation of wiring resistance RL	□		100 max, maximum cable length: 2000 m (Between input terminals)	
Synchronization time between inputs	s		Depending on configuration selected	
Outputs	Relay	Voltage reference	Volt-free	
		Safety circuit	2 N/O per function (4 N/O total) (13-14, 23-24, 33-34, 43-44)	
		Breaking capacity in AC-15	VA C300: inrush 1800, maintained 180	
		Breaking capacity in DC-13	24 V/1.5 A L/R = 50 ms	
		Thermal current (I <sub>the</sub> ) for each group of 2 outputs	A 6 for 1 output and 2 for the other, or 4 for both outputs.	
		Current limit	A I <sub>th</sub> ≤ 16 (with several relay output circuits simultaneously loaded)	
		Output fuse protection	A 4 gL or 6 quick blow	
		Minimum current	mA 10 (1)	
		Minimum voltage	V 17 (1)	
		Solid-state	Breaking capacity	24 V/2 A
	Safety circuit		6 solid-state (O1, O2, O3, O4, O5, O6)	
	Current limit		A I <sub>th</sub> ≤ 6.5 (with several solid-state output circuits simultaneously loaded)	
	Electrical durability			See page 38610-EN/2
	Response time on input opening			ms Response time = 20 or 30, configurable using software XPSMCWIN □ if 20 for controllers XPS MC●●Z●: 30 for a safety mat □ if 30 for controllers XPS MC●●Z●: 45 for a safety mat
Rated insulation voltage (U <sub>i</sub> )			V 300 (degree of pollution 2 conforming to IEC 60647-5-1, DIN VDE 0110 part 1)	
Rated impulse withstand voltage (U <sub>imp</sub> )			kV 4 (overvoltage category III, conforming to IEC 60647-5-1, DIN VDE 0110 part 1)	
LED display			30 (XPS MC16Z), 46 (XPS MC32Z) 32 (XPS MC16ZC/MC16ZP), 48 (XPS MC32ZC/MC32ZP)	
Temperature	Operating	°C	- 10...+ 55	
	Storage	°C	- 25...+ 85	
Degree of protection			IP 20 conforming to EN/IEC 60529 (connector and enclosure)	

(1) The controller is also capable of switching low power loads (17 V/10 mA minimum) provided that the contact has not been used for switching high power loads (possible contamination or wear of the gold layer on the contact tips).

Communication			
<b>Modbus® serial link</b>			
<b>Compatibility</b>		XPS MC16Z, XPS MC32Z, XPS MC16ZC, XPS MC32ZC, XPS MC16ZP, XPS MC32ZP	
Serial link ports	Number and type	1 x RJ45	
	Status	Slave	
Data exchange	14 words		
Addressing	1 ...247		
Baud rate	<b>bps</b>	1200, 2400, 4800, 9600 or 19200	
Parity	Even, odd, none		
Fixed parameters	RTU (Remote Terminal Unit) mode 1 start bit / 8 data bits 1 stop bit stop with "even" or "odd" parity 2 stop bits without parity		
Functions supported	01: 8-bit output data / 32-bit input data (0 = OFF, 1 = ON) 02: 32-bit input data / 8-bit output data (0 = OFF, 1 = ON) 03: information and detected errors		
<b>CANopen bus</b>			
<b>Compatibility</b>		XPS MC16ZC, XPS MC32ZC	
Serial link ports	Number and type	1 x SUB-D 9-pin male	
	Status	Slave	
Data exchange	14 words By included dual port memory: only data addresses, diagnostics, but no baud rates		
Parameters (adjustable using software XPSMCWIN)	Baud rate	<b>Kbps</b>	20, 50, 125, 250, 500, 800
	Address	<b>Mbps</b>	1
			1...127
<b>Profibus™ bus</b>			
<b>Compatibility</b>		XPS MC16ZP, XPS MC32ZP	
Serial link ports	Number and type	1 x SUB-D 9-pin female	
	Status	Slave	
Data exchange	14 words By included dual port memory: only data addresses		
Parameters	Baud rate	<b>Mbps</b>	12
	Address		1...125
<b>Connections</b>			
Type		Separate plug-in screw connector XPS MCTS●● (1)	Separate plug-in spring clip connector XPS MCTS●● (1)
<b>Power supply and relay output terminals</b>			
1 conductor	Without cable end		Solid or flexible cable: 0.2...2.5 mm², AWG 24-12
	With cable end	<b>mm²</b>	Without bezel, flexible cable: 0.25...2.5
		<b>mm²</b>	With bezel, flexible cable: 0.25...2.5
2 conductors	Without cable end	<b>mm²</b>	Solid or flexible cable: 0.2...1.5
	With cable end	<b>mm²</b>	Without bezel, flexible cable: 0.25...1.5
		<b>mm²</b>	Double, with bezel, flexible cable: 0.5...1.5
Tightening torque of screw terminals	<b>Nm</b>	0.5...0.6	Double, with bezel, flexible cable: 0.5...1
Wire stripping length	<b>mm</b>	10	—
<b>Other terminals</b>			
1 conductor	Without cable end		Solid or flexible cable: 0.14...1.5 mm², AWG 28-16
	With cable end	<b>mm²</b>	Without bezel, flexible cable: 0.25...1.5
		<b>mm²</b>	With bezel, flexible cable: 0.25...0.5
2 conductors	Without cable end	<b>mm²</b>	Solid cable: 0.14...0.5 Flexible cable: 0.14...0.75
	With cable end	<b>mm²</b>	Without bezel, flexible cable: 0.25...0.34
		<b>mm²</b>	Double, with bezel, flexible cable: 0.5
Enclosure fixing (conforming to DIN EN 50022)		Metal adaptor for fixing on DIN 35 mm metal rail	

(1) To be ordered separately.

# Modicon® Premium™ automation platform

## Preventa™ configurable safety controllers type XPS MC



XPS MC16Z



XPS MC32Z



XPS MC16ZC



XPS MC32ZC



XPS MC16ZP



XPS MC32ZP

### References

Configurable safety controllers (connector not included)

Number of inputs	Number of outputs		Communication	Reference	Weight kg
	Relay	Solid-state			
16	4 (2 x 2)	6	Modbus®	<b>XPS MC16Z</b>	0.820
			Modbus, CANopen	<b>XPS MC16ZC</b>	0.820
			Modbus, Profibus™	<b>XPS MC16ZP</b>	0.820
32	4 (2 x 2)	6	Modbus	<b>XPS MC32Z</b>	0.840
			Modbus, CANopen	<b>XPS MC32ZC</b>	0.840
			Modbus, Profibus	<b>XPS MC32ZP</b>	0.840

### Plug-in connectors for configurable safety controllers (1)

Description	For use with	Reference	Weight kg
Screw connectors	XPS MC16Z, MC16ZC, MC16ZP	<b>XPS MCTS16</b>	0.080
	XPS MC32Z, MC32ZC, MC32ZP	<b>XPS MCTS32</b>	0.110
Spring clip connectors	XPS MC16Z, MC16ZC, MC16ZP	<b>XPS MCTC16</b>	0.080
	XPS MC32Z, MC32ZC, MC32ZP	<b>XPS MCTC32</b>	0.110

### Configuration software

- Reference XPS MCWIN is the full version of configuration software XPSMCWIN version 2.10 and must be installed if no previous version of this software has been installed.
- Reference SSVXPSMCWINUP is an update for software XPSMCWIN and can be used if SSVXPSMCWINUP has been installed using Safety Suite V1. An update from version 2.0 to version 2.10 for the software XPSMCWIN will then be performed.

Description	Operating system	Details (2)	Languages	Reference	Weight kg
Configuration software for controllers XPS MC●●Z● CD-ROM + user manual	Windows 2000®, Windows XP®	Software available on Safety Suite V2 software pack	EN, FR, DE, IT, ES, PT	<b>XPS MCWIN</b>	0.520
XPSMCWIN software update CD-ROM + user manual	Windows 2000, Windows XP	Software available on Safety Suite V2 software pack	EN, FR, DE, IT, ES, PT	<b>SSVXPSMCWINUP</b>	0.520

(1) To be ordered separately to the controllers.

(2) EDS and GSD files are available on the XPSMCWIN configuration software CD-ROM.

4



XPS MCCPC



TSX PCX 1031



490 NT 000



TSX CUSB485



TSX CAN TDM4



ABL 8RPS24100

## References

### Connecting cables (1)

Function	Length m	Reference	Weight kg	
Diagnostics using Magelis® operator dialog terminal type XBT GT	3	VW3 A8 306 R30	1.130	
Configuration software	1 Adaptor: RJ45 socket/PC connection cables	–	XPS MCCPC 0.011	
	2 Cable to PC serial port (type SUB-D9)	2.5	TSX™ PCX 1031 0.170	
	3 Straight shielded twisted pair cables, EIA/TIA 568 standard (RJ45 connector at each end)	2	490 NTW 000 02	–
		5	490 NTW 000 05	–
		12	490 NTW 000 12	–
	Straight shielded twisted pair cables, UL and CSA 22.1 approved (RJ45 connector at each end)	2	490 NTW 000 02U	–
		5	490 NTW 000 05U	–
		12	490 NTW 000 12U	–
	with RJ45/PC USB port converter (2)	0.4	TSX™ CUSB485	–

Function	Medium	Length m	Reference	Weight kg
Modbus® serial link access	Premium™ automation platform TSX SCY 21601	–	XPS MCSCY	–
CANopen bus access	1 CANopen connection cables (fitted with: 1 SUB-D 9-pin female connector at each end)	0.3	TSX™ CANCADD03	–
		1	TSX CANCADD1	–
		3	TSX CANCADD3	–
		5	TSX CANCADD5	–
		–	TSC CANTDM4	–
	2 CANopen tap-off box	–	TSC CANTDM4	–
3 Standard CANopen cables	50	TSX CANCA50	–	
	100	TSX CANCA100	–	
	300	TSX CANCA300	–	
Profibus™ bus access	100	TSX™ PBS CA100	–	
	400	TSX PBS CA400	–	

### Accessories (1)

Regulated switch mode power supply, single-phase	Output voltage: $\approx$ 24...28.8 V Nominal current: 10 A Nominal power: 240 W	ABL 8RPS24100	1.000
--	--	---------------	-------

(1) To be ordered separately.

(2) The converter **TSX CUSB485** is installed using **Driver Pack V2.3**. This "driver" is available on the Safety Suite V2 software pack or downloadable from our site: [www.schneider-electric.com](http://www.schneider-electric.com)

## Dimensions, mounting

### XPS MC●●Z●

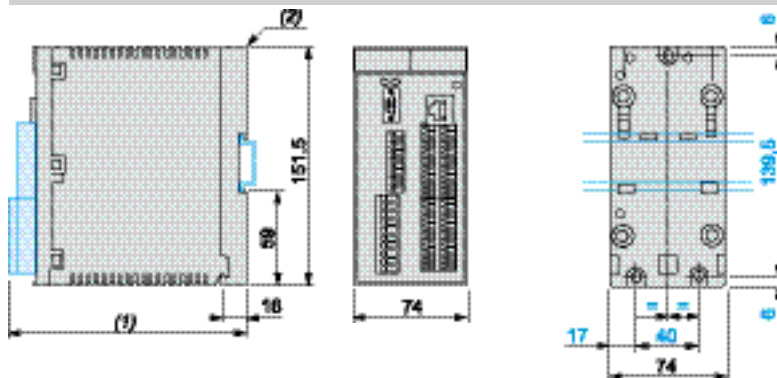

(1) 153 mm with screw connector XPS MCTS●●. 151.4 mm with spring clip connector XPS MCTC●●.

(2) Metal adaptor for fixing on metal DIN 35 mm rail.

# Modicon® Premium™ automation platform

## Counter and electronic cam modules

4

**Applications**

**Counter modules**



<b>Number of channels</b>
<b>Frequency per channel</b>
<b>Module cycle time</b>

2 channels
40 kHz
5 ms

4 channels
40 kHz
10 ms

**Counter/measurement input**

Counting pulses $\approx$ 24 V
Incremental encoder
Absolute encoder

Up to 40 kHz: Sensor type 2, Mechanical contacts
Up to 40 kHz : $\approx$ 10...30 V, $\approx$ 5 V RS 422 with zero marker
-

**Reflex inputs/outputs**

Per channel: 3 inputs $\approx$ 24 V: enable, preset and capture, 1 input $\approx$ 24 V line check, incremental encoder power supply, 2 reflex outputs $\approx$ 24 V
---

**Counting capacity**

24 bits + sign (0 to + 16 777 215 points or $\pm$ 16 777 215 points)
--

**Functions**

Downcounting with preset input, upcounting with reset to zero input Up/down counting with preset input, configurable upcounter input: - 1 upcounter input/1 downcounter input - 1 up/down counter input and 1 direction input - Incremental encoder with phase-shifted signals
--

**Processing**

Inputs: counter enable, counter preset, read current value
Comparison: - Downcounting, to value 0 - Upcounting, 2 thresholds and 1 setpoint - Up/down counting, 2 thresholds and 2 setpoints
Reflex outputs: - Downcounting function, 1 passage through zero output - Upcounting function, 1 passage through setpoint value output - Up/down counting function, 2 user-definable outputs

**Events**

User-definable activation of the event-triggered task (threshold crossing, setpoint crossing, preset or reset, enable, capture)
---

**Connection**

- 15-way SUB-D connectors (1 per counter channel, direct or TSX TAP S15 ●● accessory) - HE 10 connector for auxiliary I/O and power supply - Advantys™ Telefast® ABE 7 system (ABE 7CPA01, ABE 7H08R10/16R20)
---

**Type of module**

**TSX™ CTY 2A**

**TSX CTY 4A**

**Pages**

4/23



**Fast counter and measurement module**



**Electronic cam module**



2 channels  
500 kHz  
1 ms

1 channel

Up to 1 MHz :  
Sensors type 2,  
Mechanical contacts  
500 kHz in multiplication by 1, 250 kHz in multiplication by 4:  
- 10...30 V  
- 5 V RS 422 with zero marker  
Power supply 5 V or 10...30 V:  
- SSI absolute encoder up to 25 bits  
- Parallel absolute encoder up to 24 bits (with AdvantysTelefast ABE 7CPA11 sub-base)

-

Per channel :  
- 2 inputs 24 V: preset and read  
- 1 enable input or 24 V output, configurable  
- 2 reflex outputs 24 V  
- 1 programmable frequency output 24 V  
- 1 encoder power supply input 5 V/24 V

- 3 proximity sensor compatible inputs 24 V type I  
- 24 track outputs 24 V/0.5 A protected

24 bits + sign (0 to + 16 777 215, upcounting) or 24 bits + sign (- 16 777 215 to + 16 777 215, downcounting, up/down counting).  
Up to 25 bits for SSI absolute encoder

256 to 32 768 points per cycle and from 1 to 32 768 cycles, (absorbs play on reverse)

Up/down counting with preset input, configurable counter input:  
- 1 upcounter input/1 downcounter input  
- 1 up/down counter input and 1 direction input  
- Incremental encoder with phase-shifted signals  
Measurement 2 thresholds:  
- SSI absolute encoder  
- Parallel output absolute encoder with ABE 7CPA11 sub-base

Processing of 128 cams/32 tracks (24 with direct output)  
Output update cycle:  
- 50 µs for 16 cams  
- 100 µs for 64 cams  
- 200 µs for 128 cams  
Two capture registers  
Control/recalibration of axis slip

Inputs: counter enable, counter preset, read current value  
Comparison:  
2 thresholds

Cam profiles: 3 basic types (position, monostable, brake)  
Associated functions:  
- Elimination of axis backlash, position recalibration  
- Measurement capture  
- Switching feedforward  
- Parts counter

Sorties réflexes :  
2 sorties paramétrables.  
Surveillance de vitesse  
Fonctions spéciales

User-definable activation of the event-triggered task (crossing of thresholds or modulo value, preset, enable, capture)

User-definable activation of the event-triggered task (cams, track, adjustment, read, etc.)

- 15 way SUB-D connectors (1 per counter channel, direct or TSX TAP S15 accessory)  
- HE 10 connector for reflex I/O and power supply  
- Advantys™ Telefast® ABE 7 (ABE 7CPA01, ABE 7H16R20, ABE 7CPA11)

**TSX™ CTY 2C**

**TSX CCY 1128**

4/27

4/30

### Presentation

Counting functions are required for counting parts or events, grouping objects, incoming or outgoing flow control, and measuring the length or the position of elements.

Modicon® Premium™ PLCs perform these functions using **TSX™ CTY 2A/4A** counter modules which have a counting frequency of 40 kHz maximum. In a Premium PLC configuration, the number of TSX CTY counter modules is added to the number of other application-specific modules (communication, motion control and weighing). See pages 1/12, 1/21 and 1/31. They can be disconnected while powered up.

Counter modules are characterized by the number of channels:

- 2 channels with downcounting, upcounting and up/down counting functions for the **TSX CTY 2A** module,
- 4 channels with downcounting, upcounting and up/down counting functions for the **TSX CTY 4A** module.

The parameters of these functions are set by software configuration. The modules accept  $\pm 5\text{ V}$  or  $\pm 10$  to  $30\text{ V}$  solid state output sensors (incremental encoders, proximity sensors, photoelectric detectors) and mechanical contact output sensors (in this case the counting frequency is limited to 100 Hz).

### Description

The front panel of **TSX CTY 2A** (2-channel) and **TSX CTY 4A** (4-channel) counter modules is comprised of:

- 1 One 15-way SUB-D type connector per channel for connecting:
  - Counting sensors or incremental encoder.
  - Sensor power supply.
  - Encoder supply feedback for checking it is correctly supplied.
- 2 One 20-way HE10 type connector for 2 channels for connecting on each channel:
  - Auxiliary inputs: preset, enable.
  - Reflex outputs.
  - Power supplies for auxiliary I/O and incremental encoders.
- 3 Rigid casing which:
  - Holds the electronic card.
  - Locates and locks the module in its slot...
- 4 Module diagnostic LEDs:
  - Module diagnostics:
    - Green RUN LED: module operating,
    - Red ERR LED: detected internal fault, detected module failure,
    - Red I/O LED: detected external fault.
  - Channel diagnostics:
    - Green CH● LED: channel diagnostics available.

4

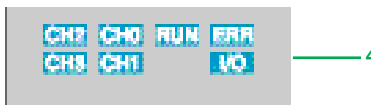
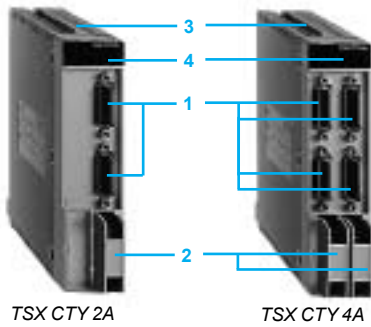

### Operation block diagram

#### Block diagram of a channel

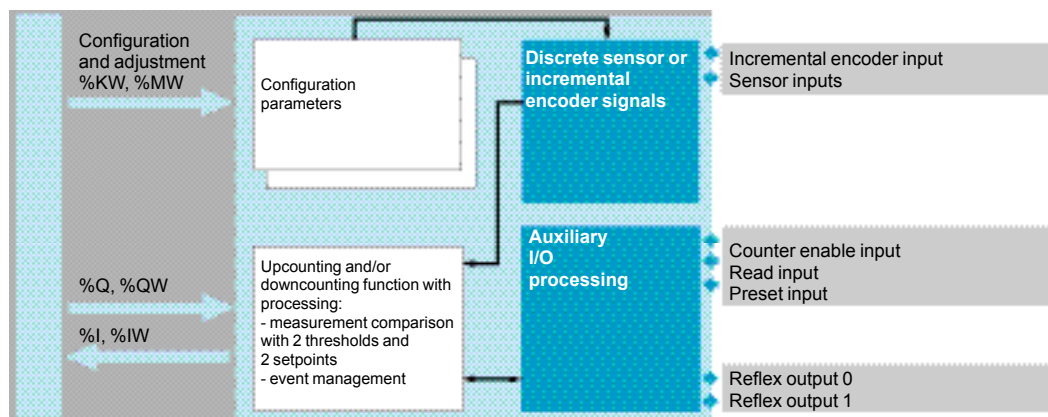

Counter modules are set up using PL7™ Junior/Pro software

Electrical characteristics			
Type of modules		TSX™ CTY 2A	TSX CTY 4A
<b>Modularity</b>		2 channels	4 channels
<b>Frequency on counter inputs</b>	<b>kHz</b>	40 maxi	40 maxi
<b>Consumption</b>	<b>mA</b>	see page 9/6	see page 9/6
<b>Dissipated power</b>	<b>W</b>	4.5 typical (6 maxi)	8 typical (11.5 maxi)
<b>Sensor power supply check</b>		yes	yes
<b>Module cycle time</b>	<b>ms</b>	5	10
<b>Event processing response time</b>		Acceptance of event-triggered input (enable/read/preset) and positioning of: - reflex output on TSX CTY 2A/4A: 1 ms - discrete module output; TSX DSY 8T22: 2.1 ms; TSX DSY 32T2K: 3.2 ms	

Input characteristics						
Type of input			Counter inputs (IA/IB/IZ)		Auxiliary inputs (preset, enable, read)	
<b>Nominal values</b>	Voltage	<b>V</b>	5	24	24	
	Current	<b>mA</b>	18	18	7	
<b>Limit values</b>	Voltage	<b>V</b>	≤ 5.5	19...30 (up to 34 V possible, limit 1 hr per 24 hr period)	19...30 (up to 34 V possible, limit 1 hr per 24 hr period)	
	At state 1	Voltage	<b>V</b>	≥ 2.4	≥ 11	
		Current	<b>mA</b>	> 3.7 (for U = 2.4 V)	> 6 (for U = 11 V)	> 6 (for U = 11 V)
	At state 0	Voltage	<b>V</b>	≤ 1.2	≤ 5	≤ 5
		Current	<b>mA</b>	< 1 (for U = 1.2 V)	< 2 (for U = 5 V)	< 2 (for U = 5 V)
<b>Logic</b>			Positive	Positive	Positive	
<b>Sensor voltage check response time</b>						
	At loss of 24 V	<b>ms</b>	–	–	< 2.5	
	At return of 24 V	<b>ms</b>	ms	–	–	
<b>Input impedance</b>	For nominal U	<b>W</b>	400	1400	3400	
	For U = 2.4 V (RS 422 compatibility)	<b>W</b>	> 270	–	–	
<b>Response time</b>			Max. permissible frequency 40 kHz with incremental encoder Immunity 1.6 ms with mechanical contact		< 250 [s]	
<b>Type of input</b>			Resistive	Resistive	Current sink	
<b>IEC/EN 61131 conformity</b>			–	Type 2	Type 2	
<b>Proximity sensor compatibility</b>			–	2-wire/3-wire	2-wire/3-wire	

Output characteristics					
Type of output			Auxiliary outputs (2 par channel)		
<b>Nominal</b>	Voltage	<b>V</b>	~ 24		
	Current	<b>mA</b>	500		
<b>Voltage limits</b>			19...30 (up to 34 V possible, limit 1 hr per 24 hr period)		
<b>Maximum voltage drop when ON</b>			<b>V</b> < 0.5		
<b>Leakage current</b>			<b>mA</b> < 0.1		
<b>Switching time</b>			<b>[s]</b> < 250		
<b>Electrostatic discharge time</b>			<b>s</b> L/R		
<b>Switching frequency on inductive load</b>			<b>Hz</b> $F < 0.6 / (LI^2)$		
<b>Compatibility</b>	With Premium d.c. inputs		Any positive logic inputs with input resistance < 15 k[		
	IEC/EN 61131		yes		
<b>Protections against</b>	Overloads and short-circuits		Current limiter and thermal tripping (reactivated via program or automatically)		
	Channel overvoltages		Zener diode between outputs and + 24 V		
	Polarity inversions		Diode reverse-mounted on supply		

Connections

Examples of connecting counter inputs

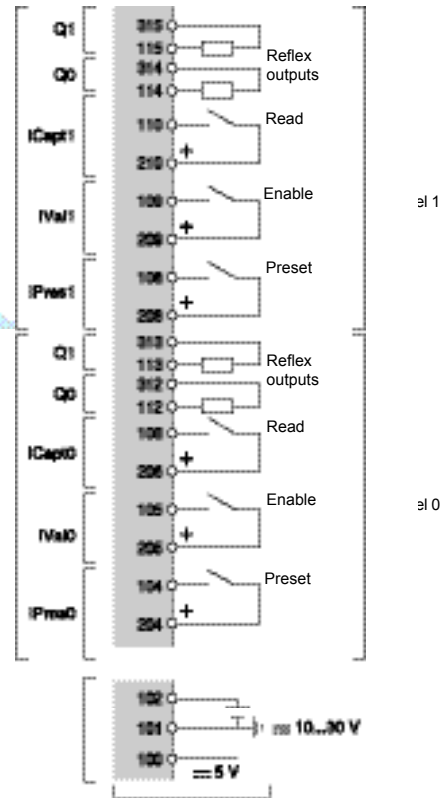
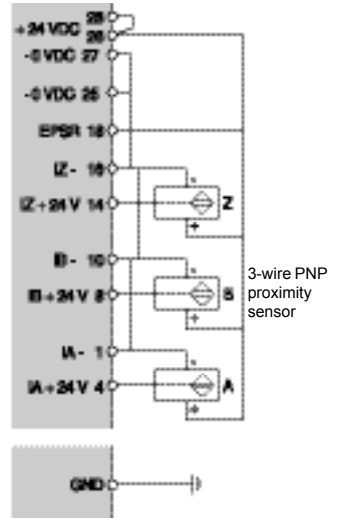
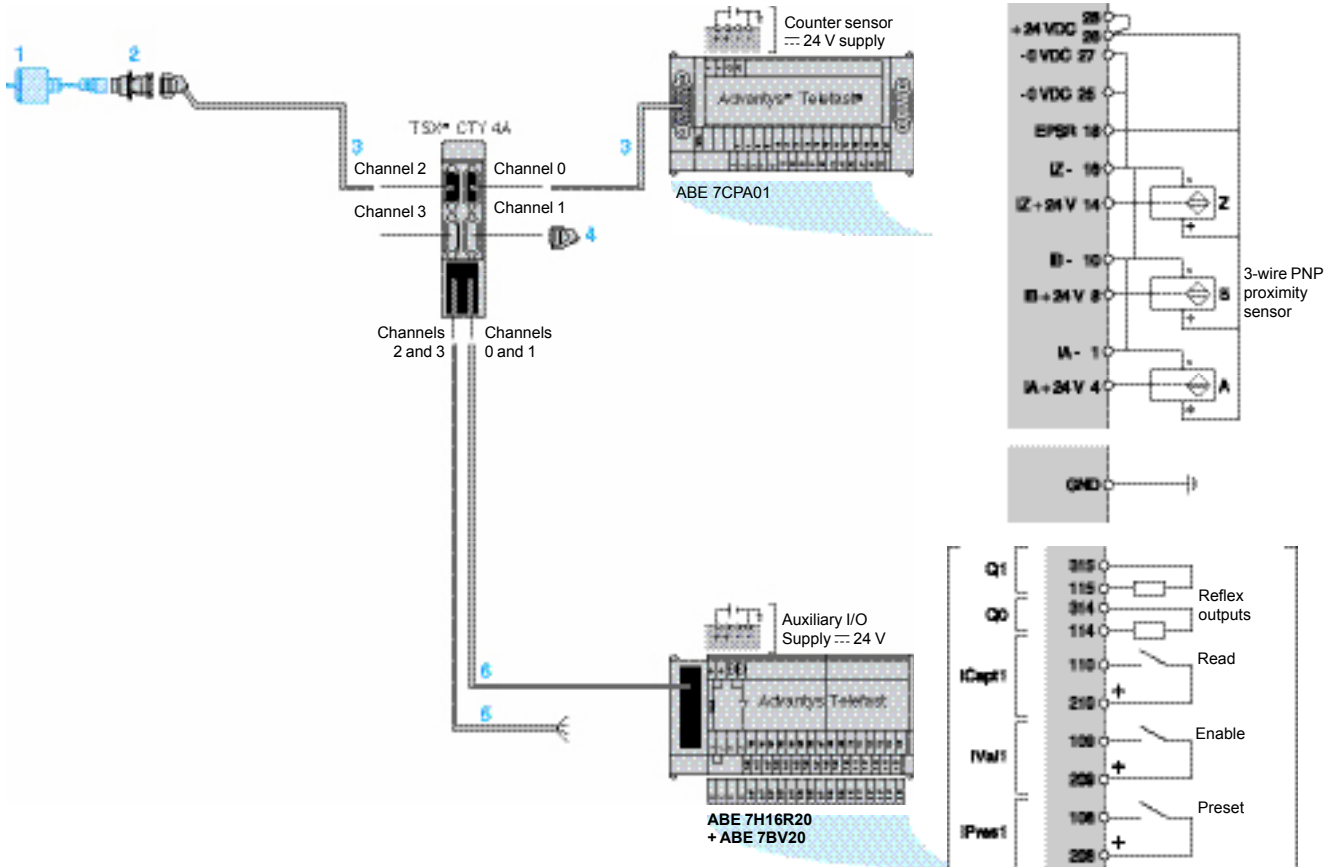

4

- 1 Incremental encoder
- 2 TSX™ TAP S15 05/24 connector

TSX TAP S15 05			TSX TAP S15 24		
1 IB-	7 NC		1 NC	7 NC	
2 Power ret.	8 IB + 5 V		2 NC	8 IB + 24 V	
3 IZ + 5V	9 NC		3 IZ + 24 V	9 NC	
4 IZ-	10 0 V		4 NC	10 0 V	
5 IA + 5 V	11 NC		5 IA + 24 V	11 NC	
6 IA-	12 + 5 V		6 NC	12 + 10...30 V	

- 3 TSX™ CCP S15 cable with connector
- 4 TSX™ CAP S15 connector
- 5 TSX™ CDP●●1 preformed cable
- 6 TSX CDP●●2 or TSX CDP ●●3 rolled ribbon or preformed cable with connectors

Dimensions

Connection interface for incremental encoder

TSX TAP S15 05/24

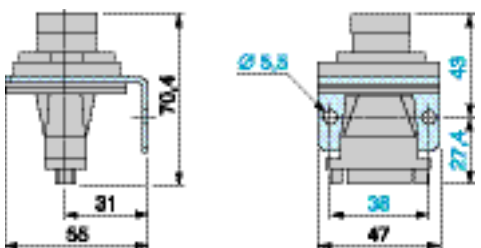

Mounting through enclosure (dust and damp proof)  
- cut-out Ø 37,  
- maximum panel thickness 5 mm.



TSX CTY 2A      TSX CTY 4A



ABE 7CPA01



ABE 7H16R20



TSX TAP S15 ●●

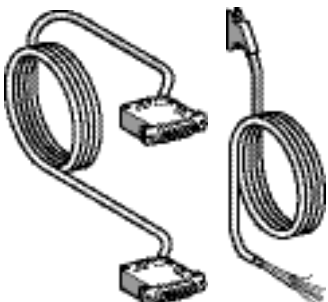

TSX CCP S15 ●●●

TSX CDP ●01



TSX CDP ●02

TSX CDP ●03

### Counter modules

Type of input	Characteristics	No. of channels	Reference	Weight kg
2/3-wire prox.sensors PNP/NPN, $\overline{\text{---}}$ 24 V, Incremental encoder $\overline{\text{---}}$ 5 V RS 422 or $\overline{\text{---}}$ 10...30 V Totem Pole	Counting 40 kHz Cycle time 5 ms	2	TSX™ CTY 2A	0.320
	Counting 40 kHz Cycle time 10 ms	4	TSX CTY 4A	0.430

### Connection accessories

Description	For connecting	Connector type on TSX CTY ●●	Rep.	Unit Reference	Weight kg
<b>SUB-D connectors</b> <i>Sold in lots of 2</i>	Counter sensors or incremental encoder	SUB-D, 15-way	4	TSX™ CAP S15	0.050
<b>Advantys™ Telefast® ABE 7 connection sub-bases</b>	Counter sensors and $\overline{\text{---}}$ 24 V power supply	SUB-D, 15-way	—	ABE 7CPA01	0.300
	Auxiliary inputs, $\overline{\text{---}}$ 24 V power supply and $\overline{\text{---}}$ 5 V/10...30 V encoder power supply	HE 10, 20-way (for 2 channels)	—	ABE 7H16R20	0.300
<b>Additional terminal block</b> <i>Order in multiples of 5</i>	20 shunted terminals for ABE 7H16R20 sub-base		—	ABE 7BV20	0.030
<b>Connection interfaces for incremental encoder</b>	Encoder $\overline{\text{---}}$ 5 V RS 422	SUB-D, 15-way	2	TSX™ TAP S15 05	0.260
	Encoder $\overline{\text{---}}$ 10...30 V Totem Pole	SUB-D, 15-way	2	TSX TAP S15 24	0.260

### Connecting cables

Description	From TSX CTY ●●	To	Rep.	Length	Reference	Weight kg
<b>Cordsets</b> AWG 12 (0.205 mm <sup>2</sup> )	15-way SUB-D connector	ABE 7CPA01/CPA11 sub-bases or TSX TAP S15●● (15-way SUB-D connector)	3	0.5 m	TSX™ CCP S15 050	0.110
				1 m	TSX CCP S15 100	0.160
				2.5 m	TSX CCP S15	0.300
<b>20-wire preformed cables</b> AWG 22 (0,324 mm <sup>2</sup> ) 500 mA max.	Auxiliary inputs, $\overline{\text{---}}$ 24 V power supply and $\overline{\text{---}}$ 5 V/10...30 V encoder power supply (HE 10, 20-way moulded connector)	Free end with color-coded wires	5	3 m	TSX™ CDP 301	0.400
				5 m	TSX CDP 501	0.660
				10 m	TSX CDP 1001	1.210
<b>Rolled ribbon cable</b> AWG 28 (0,08 mm <sup>2</sup> ) 100 mA max.	Auxiliary inputs, $\overline{\text{---}}$ 24 V power supply and $\overline{\text{---}}$ 5 V/10...30 V encoder power supply (HE 10, 20-way connector)	ABE 7H16R20 sub-base (HE 10, 20-way connector)	6	1 m	TSX CDP 102	0.090
				2 m	TSX CDP 202	0.170
				3 m	TSX CDP 302	0.250
<b>Connecting cables</b> AWG 22 (0,324 mm <sup>2</sup> ) 500 mA max.	Auxiliary inputs, $\overline{\text{---}}$ 24 V power supply and $\overline{\text{---}}$ 5 V/10...30 V encoder power supply (HE 10, 20-way connector)	ABE 7H16R20 sub-base (HE 10, 20-way connector)	6	0.5 m	TSX CDP 053	0.085
				1 m	TSX CDP 103	0.150
				2 m	TSX CDP 203	0.280
				3 m	TSX CDP 303	0.410
				5 m	TSX CDP 503	0.670
				10 m	TSX CDP 1003	1.180

### Presentation

The **TSX™ CTY 2C** measurement and counter module is used with fast machines requiring precise measurements with short cycle times and high input frequencies (timber machines, packing machines, etc).

The **TSX CTY 2C** measurement and counter module provides the standard functions (speed monitoring, reflex outputs, etc) enabling a simple position control function to be performed by the application program.

The **TSX CTY 2C** measurement and counter module also enables special functions to be managed.

### Description

The front panel of a **TSX CTY 2C** measurement and counter module is comprised of:

- 1 One 15-way SUB-D connector per channel for connecting:
  - Counting sensors or incremental encoder,
  - SSI absolute encoder or parallel output encoder with **ABE 7CPA11** sub-base,
  - Sensor power supply,
  - Encoder power supply feedback for checking it is correctly supplied.
- 2 One 20-way HE10 connector for connecting on each channel :
  - Auxiliary inputs: preset, enable and read,
  - Reflex outputs,
  - Programmable frequency output,
  - Power supplies for auxiliary I/O and encoders.
- 3 Rigid casing which:
  - Holds the electronic card,
  - Locates and locks the module in its slot...
- 4 Module diagnostic lamps:
  - Module diagnostic:
    - Green RUN: module operating.
    - Red ERR lamp: detected internal fault, detected module failure.
    - Red I/O lamp: detected external fault.
  - Channel diagnostic:
    - Green CH● lamp: channel diagnostics available.

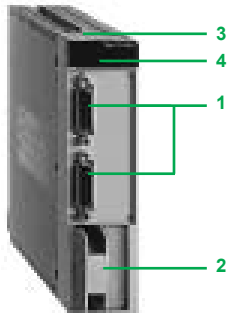

TSX CTY 2C

4



### Operation block diagram

#### Block diagram of a channel

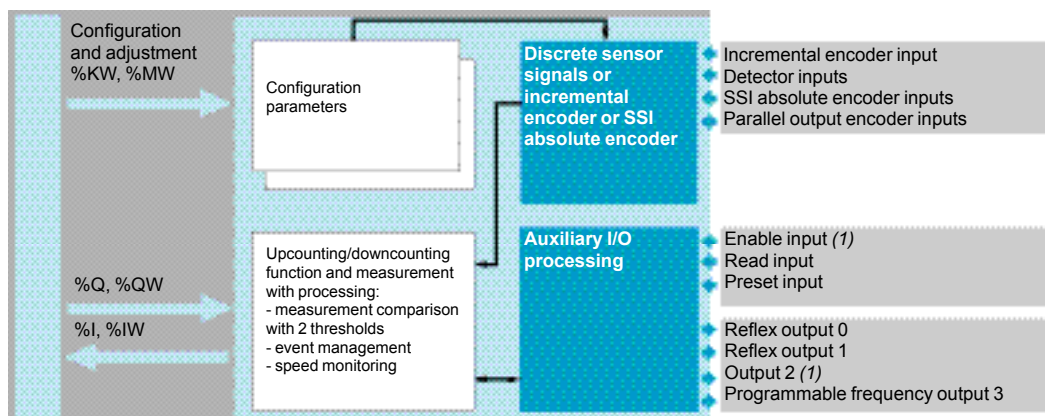

Counter modules are set up using Unity™ Pro or PL7™ Junior/Pro software

(1) The enable input and output 2 cannot be used simultaneously.

Electrical characteristics					
Type of module			TSX™ CTY 2C		
<b>Modularity</b>			2 channels		
<b>Frequency on counter inputs</b>			Counting: 1 MHz. With phase-shifted signal encoder: multiplication by 1: 500 kHz, multiplication by 4: 250 kHz		
<b>Consumption</b>			<b>mA</b>	see page 9/6	
<b>Dissipated power</b>			<b>W</b>	7 typical (10 max.)	
<b>Sensor power supply check</b>			Yes		
<b>Module cycle time</b>			<b>ms</b>	1 (for 2 channels)	
<b>Event processing response time</b>			<b>ms</b>	Acceptance of event-triggered input (enable/read/preset) and positioning of - a reflex output: 1 ms - discrete output modules <b>TSX DSY 8T22</b> : 2.1 ms ; <b>TSX DSY 32T2K</b> : 3.2 ms.	
Input characteristics					
Type of input			Counter inputs IA/IB/IZ or SSI absolute encoder		Auxiliary inputs (preset, enable, read)
<b>Nominal values</b>	Voltage	<b>V</b>	5	24	24
	Current	<b>mA</b>	18	16	8
<b>Limit values</b>	Voltage	<b>V</b>	≤ 5.5	19...30 (up to 34 V possible, limited to 1 hr per 24 hr period)	19...30 (up to 34 V possible, limited to 1 hr per 24 hr period)
	At state 1	Voltage	<b>V</b>	≥ 2.4	≥ 11
		Current	<b>mA</b>	> 3.6 (for U = 2.4 V)	> 6 (for U = 11 V)
	At state 0	Voltage	<b>V</b>	≤ 1.2	≤ 5
		Current	<b>mA</b>	< 1 (for U = 1.2 V)	< 2 (for U = 5 V)
<b>Logic</b>			Positive	Positive	Positive
<b>Sensor voltage check response time</b>	At loss of 24 V	<b>ms</b>	–	–	< 2.5
	At return of 24 V	<b>ms</b>	–	–	< 10
<b>Input impedance</b>	For nominal U	<b>W</b>	400	1500	3400
<b>Input impedance for U = 2.4 V (RS 422 compatibility)</b>		<b>W</b>	> 270	–	–
<b>Response time</b>			<b>ms</b>	–	< 50
<b>Type of input</b>			Resistive	Resistive	Current sink
<b>IEC/EN 61131 conformity</b>			–	Type 2	Type 2
<b>Proximity sensor compatibility</b>			–	2-wire/3-wire	2-wire/3-wire
Output characteristics					
Type of output			Auxiliary outputs (2 per channel)		
<b>Nominal values</b>	Voltage	<b>V</b>	--- 24		
	Current	<b>mA</b>	500		
<b>Voltage limits</b>			<b>V</b>	19...30 (up to 34 V possible, limited to 1 hr per 24 hr period)	
<b>Maximum voltage drop at state 1</b>			<b>V</b>	< 0.5	
<b>Leakage current</b>			<b>mA</b>	< 0.1	
<b>Switching time</b>			<b>ms</b>	< 250	
<b>Electrostatic discharge time</b>			<b>s</b>	L/R	
<b>Switching frequency on inductive load</b>			<b>Hz</b>	F < 0.6 / (LI²)	
<b>Compatibility</b>	With Premium d.c. inputs		Any positive logic inputs with input resistance < 15 kW		
	IEC/EN 61131-2		Yes		
<b>Protection against</b>	Overloads and short-circuits		Current limiter and thermal tripping (reactivation via program or automatically)		
	Channel overvoltages		Zener diode between outputs and + 24 V		
	Polarity inversions		Diode reverse-mounted on supply		

### Connections

#### Examples of connecting counter inputs

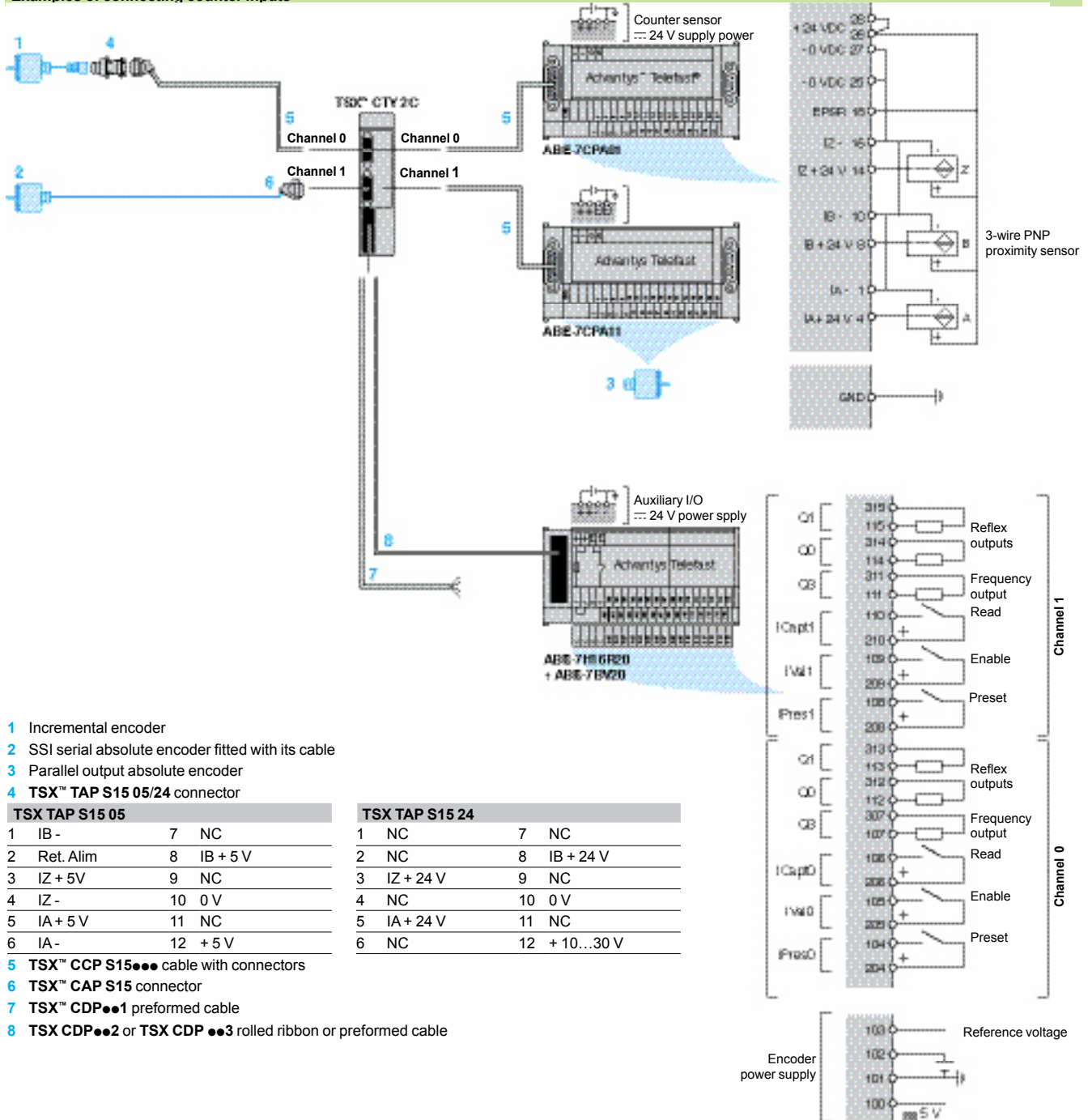

- 1 Incremental encoder
  - 2 SSI serial absolute encoder fitted with its cable
  - 3 Parallel output absolute encoder
  - 4 TSX™ TAP S15 05/24 connector
- | TSX TAP S15 05 |           |            | TSX TAP S15 24 |           |                |
|----------------|-----------|------------|----------------|-----------|----------------|
| 1              | IB -      | 7 NC       | 1              | NC        | 7 NC           |
| 2              | Ret. Alim | 8 IB + 5 V | 2              | NC        | 8 IB + 24 V    |
| 3              | IZ + 5V   | 9 NC       | 3              | IZ + 24 V | 9 NC           |
| 4              | IZ -      | 10 0 V     | 4              | NC        | 10 0 V         |
| 5              | IA + 5 V  | 11 NC      | 5              | IA + 24 V | 11 NC          |
| 6              | IA -      | 12 + 5 V   | 6              | NC        | 12 + 10...30 V |
- 5 TSX™ CCP S15●●● cable with connectors
  - 6 TSX™ CAP S15 connector
  - 7 TSX™ CDP●●1 preformed cable
  - 8 TSX CDP●●2 or TSX CDP ●●3 rolled ribbon or preformed cable

### Dimensions

#### TSX TAP S15 05/24

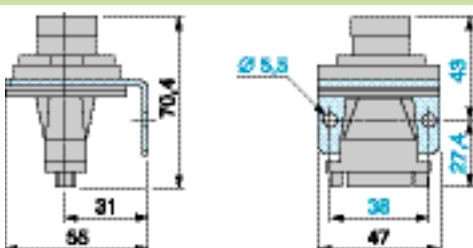

Mounting through enclosure (dust and damp proof):  
 - cut-out Ø 37  
 - maximum panel thickness 5 mm



# Modicon® Premium™ automation platform

## TSX™ CTY 2C measurement and counter module

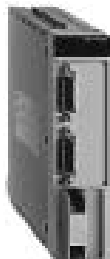

TSX CTY 2C



ABE 7CPA01



ABE 7H16R20



TSX TAP S15 ●●



TSX CCP S15 ●●●



TSX CDP ●01

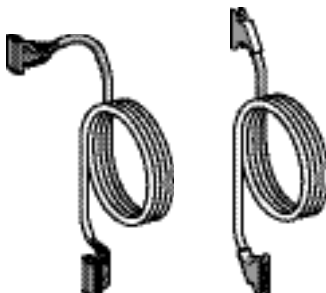

TSX CDP ●02



TSX CDP ●03

Measurement and counter module					
Type of input	Characteristics	Nb of channels	Reference	Weight kg	
2/3-wire prox.sensors PNP/NPN ∓ 24 V Incremental encoder ∓ 5 V RS 422 or ∓ 10...30 V Totem Pole	Counting Cycle time 1 ms	2	TSX™ CTY 2C	0.340	
SSI serial or parallel output absolute encoders with ABE 7CPA11 sub-base	Cycle time 1 ms				

Connection accessories					
Description	For connecting	Connector type on TSX™ CTY 2C	Rep.	Unit reference	Weight kg
SUB-D connector Sold in lots of 2	Counter sensors or incremental encoder	SUB-D, 15-way	6	TSX™ CAP S15	0.050
Advantys™ Telefast® ABE 7 connection sub-bases	Counter sensors and ∓ 24 V power supply	SUB-D, 15-way	–	ABE 7CPA01	0.300
	Auxiliary inputs, supply ∓ 24 V and encoder supply ∓ 5 V/10...30 V	HE 10, 20-way (for 2 channels)	–	ABE 7H16R20	0.300
Additional terminal block Order in multiples of 5	20 shunted terminals for ABE 7H16R20 sub-base	–	–	ABE 7BV20	0.060
Adaptor sub-base for TSX CTY 2C module (1)	Parallel output absolute encoders ∓ 5 V, ∓ 10...30 V	SUB-D, 15-way	–	ABE 7CPA11	0.300
Connection interfaces for incremental encoder	Encoder ∓ 5 V RS 422	SUB-D, 15-way	4	TSX™ TAP S15 05	0.260
	Encoder ∓ 10...30 V Totem Pole	SUB-D, 15-way	4	TSX TAP S15 24	0.260

Connecting cables						
Description	From TSX CTY 2C module	To	Rep.	Length	Reference	Weight kg
Cordsets AWG 12 (0.205 mm²)	15-way, SUB-D connector	ABE 7CPA01/CPA11 sub-base or TSX TAP S15●● accessory (15-way, SUB-D connector)	5	0.5 m	TSX™ CCP S15 050	0.110
				1 m	TSX CCP S15 100	0.160
				2.5 m	TSX CCP S15	0.300
20-wire preformed cables AWG 22 (0,324 mm²) 500 mA max.	Auxiliary inputs supply ∓ 24 V and encoder supply ∓ 5 V/10...30 V (20-way, HE 10 moulded connector)	Free end with flying leads	7	3 m	TSX™ CDP 301	0.400
				5 m	TSX CDP 501	0.660
				10 m	TSX CDP 1001	1.210
Rolled ribbon cables AWG 22 (0,08 mm²) 100 mA max.	Auxiliary inputs supply ∓ 24 V and encoder supply ∓ 5 V/10...30 V (20-way, HE 10 connector)	ABE 7H16R20 Telefast® 2 sub-base (20-way, HE 10 connector)	8	1 m	TSX CDP 102	0.090
				2 m	TSX CDP 202	0.170
				3 m	TSX CDP 302	0.250
Connecting cables AWG 22 (0,324 mm²) 500 mA max.	Auxiliary inputs supply ∓ 24 V and encoder supply ∓ 5 V/10...30 V (20-way, HE 10 moulded connector)	ABE 7H16R20 Telefast 2 sub-base (20-way, HE 10 connector)	8	0.5 m	TSX CDP 053	0.085
				1 m	TSX CDP 103	0.150
				2 m	TSX CDP 203	0.280
				3 m	TSX CDP 303	0.410
				5 m	TSX CDP 503	0.670
				10 m	TSX CDP 1003	1.180

(1) Enables multiplexing of 2 absolute encoders on the same channel (up to 4 absolute encoders when using 2 ABE 7CPA11 adaptor sub-bases).



# Modicon® Premium™ automation platform

## TSX™ CCY 1128 electronic cam module

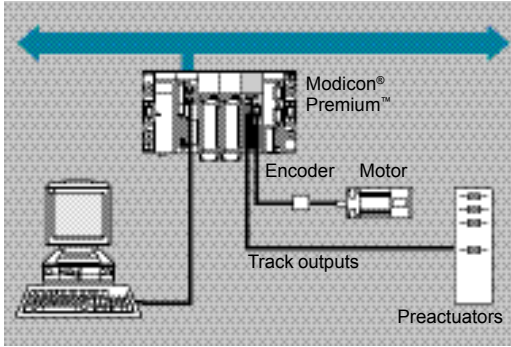

The **TSX™ CCY 1128** module performs the “electronic cam” function for an animated axis of a rotary movement in a single direction, alternating, cyclical (with periodic arrival of parts for processing) or endless (with random arrival of parts for processing). The axis is managed by an incremental or absolute encoder.

The **TSX CCY 1128** electronic cam module independently manages up to 128 cams on up to 32 tracks with as many as 24 discrete physical outputs and 8 logic outputs. Processing is structured in 4 groups of 8 tracks each, with groups 0 and 1 associated with the module connector 0 and groups 2 and 3 with connector 1.

The **TSX CCY 1128** module can be used for the following functions: elimination of axis backlash, position recalibration, capturing measurements (part length, number of points per revolution, angle of arrival of parts, slip, etc), anticipation of switching, parts counter, generating events.

Like other application-specific modules, the **TSX CCY 1128** module can be installed in any slot of a Premium PLC, except those dedicated to the power supply and the processor.

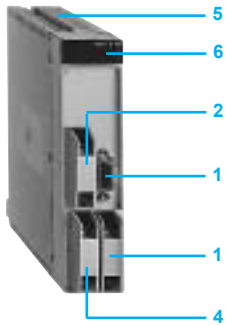

TSX CCY 1128



### Description

The front panel of the **TSX CCY 1128** electronic cam module is comprised of:

- 1 One 15-way SUB-D connector for connecting the incremental or absolute encoder.
- 2 One 20-way HE 10 connector for connecting the track outputs on groups 0 and 1 (connector 0).
- 3 One 20-way HE 10 connector for connecting the track outputs on groups 2 and 3 (connector 1).
- 4 One 20-way HE 10 connector for connecting the auxiliary inputs and the encoder power supply.
- 5 Rigid casing for the following functions:
  - Holding the electronic cards,
  - Attaching and locking the module in its slot.
- 6 Module diagnostic indicator lights:
  - Module diagnostics:
    - green RUN indicator lamp: module on,
    - red ERR indicator lamp, detected internal fault, module defective,
    - red I/O indicator lamp, detected external or application fault.
  - Channel diagnostics:
    - green CH0 indicator lamps, channel diagnostics operative.

### Operation

#### Block diagram of channel

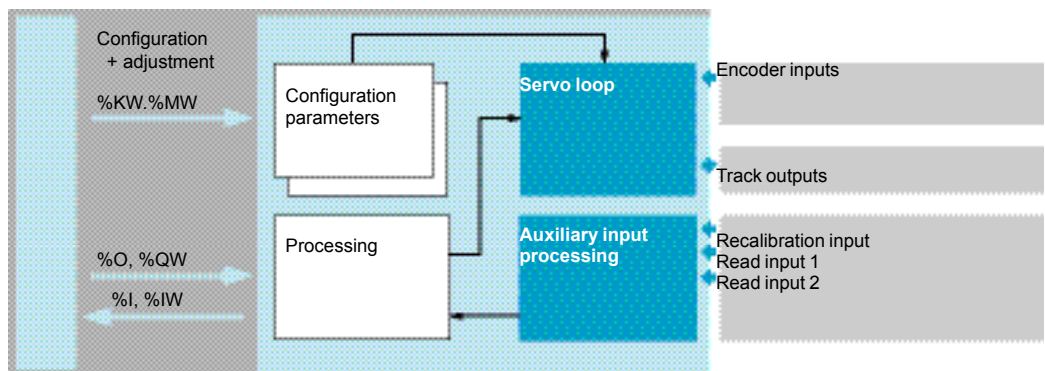

The electronic cam module is set up using Unity™ Pro or PL7™ Junior/Pro.

Operating characteristics	
Number of cams	128 position, monostable, brake type
Number of tracks	32 (24 directly associated with the 24 physical outputs, 8 logic)
Position encoder inputs	Incremental with RS 422/485 line emitter or Totem Pole output Absolute with SSI serial link Absolute with parallel outputs (via ABE 7CPA11 adaptor sub-base)
Controlled outputs	24 discrete outputs 24 V, 0.5 A
Associated functions	Elimination of axis backlash, position recalibration, measurement capture, switching feedforward, parts counter, generation of events

Electrical characteristics	
Modularity	1 axis
Max.frequency on encoder input	
SSI absolute encoder 8 to 25 bits	CLK transmission frequency kHz 200
Incremental encoder x 1	kHz 500
Incremental encoder x 4	kHz 250
Cosumption	On $\pm$ 5 V and $\pm$ 24 V mA See page 9/6
	On 10...30 V mA 11 (use of an SSI encoder and single 24 V power supply)
Power dissipated in the module (typical)	W 7
Monitoring of sensor/preactuator power supplies	Yes
Output refresh cycle	µs 50 (up to 16 cams), 100 (up to 32 cams), 200 (up to 128 cams)

Input characteristics		Encoder inputs (IA/IB/IZ) with RS 422		with 10...30 V	Auxiliary inputs (recalibration, capture 0, capture 1)
Type of input		Differential inputs		Positive or negative	Positive
Logic					
Nominal values	Voltage V	–		24	24
	Current mA	10		15.5	8
	Sensor power supply V	≤ 5.5		19...30 (possible up to 34 V limited to 1 hr in 24 hrs)	
Limit values	At state 1	Voltage > 3		≥ 11	≥ 11
		Current mA > 5.8		> 5	> 3
	At state 0	Voltage V ≤ - 3		< 5	< 5
		Current mA ≤ - 5.8		< 2	< 1.5
Input impedance for nominal U	Ω	–		1500	3000
Type of input		Resistive		Resistive	Resistive
Response time	µs	–		–	< 100
Conformity with IEC/EN 61131		–		–	Type 1
Compatibility sensors	2-wire V	–		–	Yes (with 24 V)
	3-wire mA	–		–	Yes (with 24 V)

Output characteristics		Track outputs	
Type of output			
Nominal values	Voltage V	24	
	Current mA	500	
Limit voltage	V	19...30 (possible up to 34 V limited to 1 hr in 24 hrs)	
Max.current	Per output for U $\pm$ 30 or 34 V mA	600	
	Per connectorr A	≤ 6	
	Per module A	≤ 12	
Maximum power for tungsten filament lamp	W	10	
Switching frequency on an inductive load	Hz	< 0.6/LI <sup>2</sup>	
Electro. discharge time	s	< L/R	
Preactuator voltage monitoring threshold	OK V	> 18	
	Detected fault V	< 14	
Compatibility with d.c. inputs		Any positive logic inputs whose input resistance is < 15 kΩ	
Protection against	Overloads and short-circuits	By current limiter and thermal circuit-breaker	
	Overvoltages on outputs	By Zener diode between the outputs and the + 24 V	
	Polarity inversions	By reverse diode on the power supply	
Conformity with IEC/EN 61131-2		Yes	

### Connections

#### Examples of encoder connections

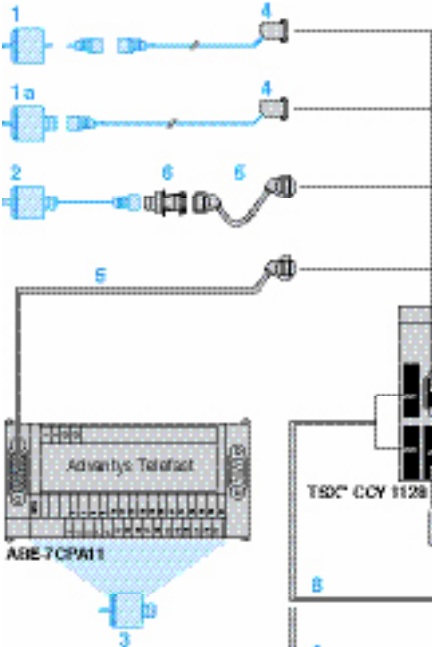

#### Examples of auxiliary input connections

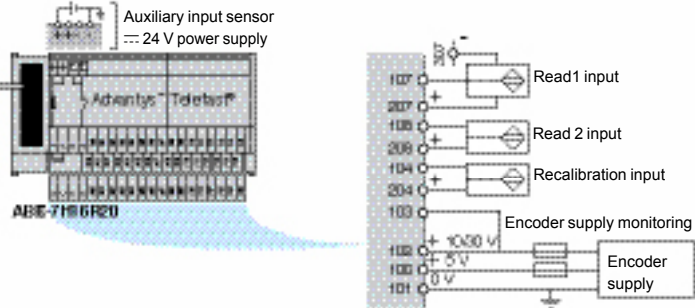

#### Example of track output preactuator connection

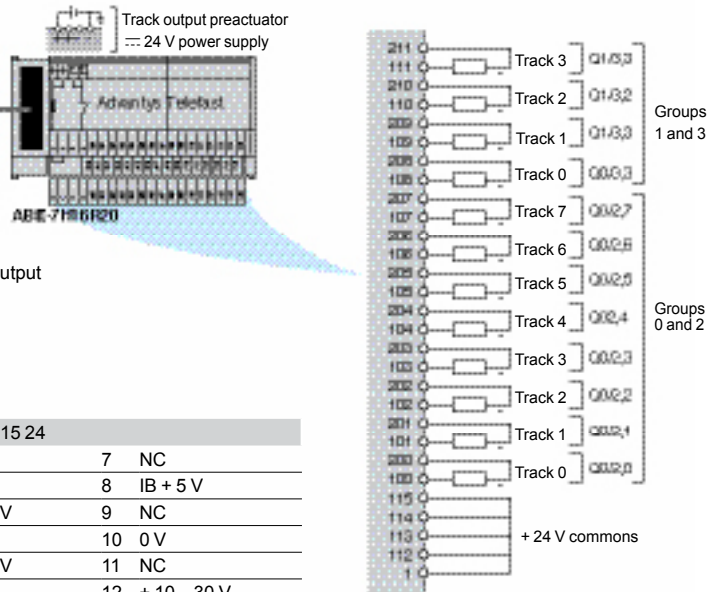

- 1 Incremental or absolute encoder
- 1 Incremental or absolute encoder with 12-way DIN connector output
- 2 5 V RS 422/485 Totem Pole incremental encoder
- 3 Absolute encoder with parallel outputs
- 4 TSX™ CAP S15 connector
- 5 TSX™ CCP S15 cable with connectors
- 6 TSX™ TAP S15 05/24 connector
- 7 TSX™ CDP cable with connectors
- 8 TSX CDP preformed cable with flying leads
- 9 TSX CDP cable with connectors

TSX TAP S15 05	
1 IB-	7 NC
2 Sup.Ret.	8 IB + 5 V
3 IZ + 5 V	9 NC
4 IZ -	10 0 V
5 IA + 5 V	11 NC
6 IA -	12 + 5 V

TSX TAP S15 24	
1 NC	7 NC
2 NC	8 IB + 5 V
3 IZ + 24 V	9 NC
4 NC	10 0 V
5 IA + 24 V	11 NC
6 NC	12 + 10...30 V

### Dimensions

#### Connection interface for TSX TAP S15 05/24 incremental encoder

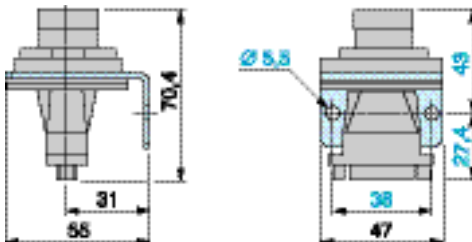

Enclosure feedthrough mounting (dust and damp proof)  
 - cut-out Ø 37,  
 - maximum panel thickness 5 mm.

# Modicon® Premium™ automation platform

## TSX™ CCY 1128 electronic cam module



TSX CCY 1128



ABE 7CPA11



ABE 7H16R20



TSX TAP S15



TSX CCP S15

TSX CDP



TSX CDP

### Electronic cam module

Type of output	Characteristics	Nb of axes	Reference	Weight kg
<b>Incremental encoder</b> Supplied with 5 V or 10...30 V, with RS 422/485, or 5 V Totem Pôle outputs (1) encoder	500 kHz counting with incremental	1	<b>TSX™ CCY 1128</b>	0.480
<b>Absolute encoder</b> RS 485 serial or parallel (2)	Acquisition 200 kHz with serial absolute encoder			

### Connection accessories

Description	For connection of	Type of connectors on TSX CCY 1128	Ref. (3)	Unit reference	Weight kg
<b>SUB-D connector</b> Sold in lots of 2	SSI absolute/incremental encoder	15-way SUB-D	<b>4</b>	<b>TSX™ CAP S15</b>	0.050
<b>Advantys™ Telefast® ABE 7 adaptor sub-base</b>	Absolute encoder with parallel outputs (16 to 24 bits) --- 5 V, 10...30 V	15-way SUB-D	—	<b>ABE 7CPA11</b>	0.300
<b>Advantys Telefast ABE 7 connection sub-base</b>	Auxiliary inputs, --- 5...24 V encoder power supply Track outputs	20-way HE 10 (1 per module) 20-way HE 10 (1 per 2 groups)	—	<b>ABE 7H16R20</b>	0.300
<b>Additional terminal block</b> Order in multiples of 5	20 shunted terminals for ABE 7H16R20 sub-base	—	—	<b>ABE 7BV20</b>	0,060
<b>Connection interfaces for incremental encoder</b>	--- 5 V RS 422/RS 485 encoder --- 10...30 V Totem Pôle	15-way SUB-D 15-way SUB-D	<b>6</b> <b>6</b>	<b>TSX™ TAP S15 05</b> <b>TSX TAP S15 24</b>	0.260 0.260

### Connection cables



Description	From	To	Ref. (3)	Length	Reference	Weight kg
<b>Cordsets</b> AWG 12 (0.205 mm²)	TSX CCY 1128 module 15-way SUB-D connector	ABE 7CPA11 adaptor sub-base or	<b>5</b>	0.5 m	<b>TSX™ CCP S15 050</b>	0.110
		TSX TAP S15 ●● interface (15-way SUB-D connector)		1 m	<b>TSX CCP S15 100</b>	0.160
				2.5 m	<b>TSX CCP S15</b>	0.220
<b>Preformed cables with flying leads</b> AWG 22 (0.324 mm²) 500 mA max.	TSX CCY 1128 module 20-way insulated HE 10 connector	Auxiliary inputs, power supply signals (free end)	<b>8</b>	3	<b>TSX CDP 301</b>	0.400
				5	<b>TSX CDP 501</b>	0.660
				10	<b>TSX CDP 1001</b>	1.210
<b>Connection cables</b> AWG 22 (0.324 mm²) 500 mA max.	TSX CCY 1128 module 20-way insulated HE 10 connector	ABE 7H16R20 sub-base (20-way HE 10 connector)	<b>7, 9</b>	0.5	<b>TSX CDP 053</b>	0.085
				1	<b>TSX CDP 103</b>	0.150
				2	<b>TSX CDP 203</b>	0.280
				3	<b>TSX CDP 303</b>	0.410
				5	<b>TSX CDP 503</b>	0.670
	10	<b>TSX CDP 1003</b>	1.180			

(1) Totem Pole encoder with complementary Push/Pull outputs.  
 (2) Absolute encoders with parallel outputs with **ABE 7CPA11** adaptor interface.  
 (3) Diagram references (see page 4/30 of this catalog).

# Modicon® Premium™ automation platform

## Motion control modules

4

Applications	Motion control modules for stepper motor		Motion control modules for servo motors Compatible with: - Lexium® 15 servo drives with analog setpoint - Altivar® ATV 61/71 variable speed drives	
				
Number of axes	1 axis	2 axes	2 axes	4 axes
Frequency per axis	187 kHz		Counter: 500 kHz with incremental encoder Acquisition: 200 kHz with SSI serial absolute encoder or parallel output	
Counter input	Per axis: Translator inputs $\leq$ 5 V, negative logic (translator loss of step checks)		Per axis: - Incremental encoder $\leq$ 5 V, RS 422/RS 485 or Totem pole - SSI serial absolute encoder 16 to 25 bits $\leq$ 10...30 V - Parallel output absolute encoder 16 to 24 bits $\leq$ 5/10/30 V with Advantys™ Telefast® ABE 7 conversion sub-base (ABE 7CPA11)	
Control outputs	Per axis: RS 422 translator outputs, TTL 5 V compatible (+/- pulses, boost, enable, reset loss of step check)		Per axis: 1 analog output $\pm$ 10 V, 13 bits + sign, servodrive setpoint	
Auxiliary input/output	Per axis: 6 discrete inputs $\leq$ 24 V 1 output $\leq$ 24 V (brake control)		Per axis: 4 discrete I/O $\leq$ 24 V (homing cam, event, recalibration, emergency stop) 1 input/1 output for servodrive control 1 reflex output $\leq$ 24 V	
Counter capacity	24 bits + sign ( $\pm$ 16 777 215 points)			
Functions			Servo Control on individual linear axis	
Processing	Open loop control of the position of a moving part on a limited linear axis according to motion control functions supplied by the PLC processor  Axis parameter setting, adjustment and debugging using PL7™ Junior/Pro and Unity™ Pro software		Positioning of a moving part on an axis according to motion control functions supplied by the Modicon® Premium™ PLC processor  Axis parameter setting, adjustment and debugging using PL7 Junior/Pro and Unity Pro software	
Events	User-definable activation of the event-triggered task			
Connection	- 15-way SUB-D connector for translator - 20-way HE 10 connector for auxiliary I/O - Advantys Telefast ABE 7 system (ABE 7H16R20)		- 9 and 15-way SUB-D connectors for encoder input (direct or via TSX TAP S15●●), speed reference - HE 10 connector for auxiliary inputs - Advantys Telefast ABE 7 system (ABE 7CPA01 / 7H16R20, ABE 7CPA11), - Specific accessories (TSX™ TAP MAS)	
Type of modules	TSX™ CFY 11      TSX CFY 21		TSX™ CAY 21      TSX CAY 41	
Page	4/37		4/42	

Motion control modules for servo motors  
Compatible with:  
- Lexium® 15 servo drives with analog setpoint  
- Altivar® ATV 61/71 variable speed drives



2 axes                      4 axes                      3 axes

Counter: 500 kHz with incremental encoder  
Acquisition: 200 kHz with SSI serial absolute encoder or parallel output

Per axis:  
- Incremental encoder  $\pm$  5 V, RS 422/RS 485 or Totem pole,  
- SSI serial absolute encoder 12 to 25 bits  
Parallel output absolute encoder 12 to 24 bits  $\pm$  5/10/30 V with Advantys™ Telefast® ABE 7 conversion sub-base (ABE 7CPA11)

Per axis:  
1 analog output  $\pm$  10 V, 13 bits + sign, servodrive setpoint

Per axis:  
4 discrete I/O  $\pm$  24 V (homing cam, event, recalibration, emergency stop)  
1 input/1 output for servodrive control  
1 reflex output  $\pm$  24 V

Servo control on individual infinite axis  
Follower axes (dynamic ratio)  
Realtime correction of servodrive offset  
Flying shear on position or event (1)

Servo control on individual linear or infinite axis  
Linear interpolation on 2 or 3 axes  
Realtime correction of servodrive offset

Positioning of a moving part on an axis according to motion control functions supplied by the Modicon® Premium™ PLC processor

Axis parameter setting, adjustment and debugging using PL7™ Junior/Pro and Unity™ Pro software

User-definable activation of the event-triggered task

- 9 and 15-way SUB-D connectors for encoder input (direct or via TSX TAP S15●●), speed reference  
- HE 10 connector for auxiliary inputs  
- Advantys Telefast ABE 7 system (ABE 7CPA01, ABE 7H16R20, ABE 7CPA11),  
- Specific accessories (TSX TAP MAS)  
-

**TSX™ CAY 22**

**TSX CAY 42**

**TSX CAY 33**

4/42

Motion control modules for servo motors  
Compatible with Lexium 15 servo drives equipped with optional SERCOS™ card



8 axes                      16 axes

SERCOS™ ring: 4 M bauds

Per SERCOS digital link

Per SERCOS digital link

Per SERCOS digital link

Individual linear or infinite axis  
Linear interpolation on 2 to 8 axes  
Follower axes (6 slaves) by gearing or camming  
Manual mode (JOG and INC) (1)  
Special functions, see page 4/50

Axis parameter setting, adjustment and debugging using PL7 Junior/Pro software and Unity Pro software (2)

2 SMA type connectors for plastic (or glass) fiber-optic cable

**TSX™ CSY 84**  
**TSX CSY 85 (3)**

**TSX CSY 164**

4/53

(1) Function not available with Premium platform under Unity Pro software.  
(2) The Unity Pro software version  $\leq$  V 2.0 is not compatible with the **TSX CSY 164** module.  
(3) **TSX CSY 85** with path functions : 2 groups of 3 axes or 3 groups of 2 axes. With linear and circular interpolation with links via polynomial interpolation.

# Modicon® Premium™ automation platform

## TSX™ CFY 11/21 modules for stepper motors

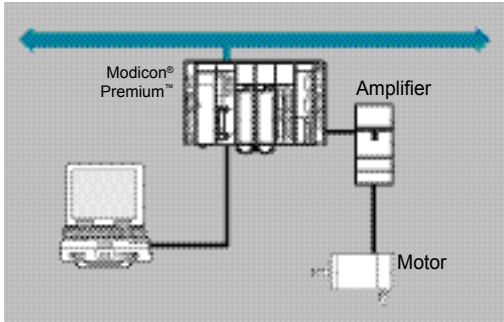

### Presentation

The **TSX™ CFY 11/21** stepper motor axis control range is intended for machines which simultaneously require motion control by stepper motor associated with sequential control by programmable controller.

The **TSX CFY 11** module controls, via an amplifier for stepper motor, 1 axis (channel 0). The **TSX CFY 21** module controls 2 axes (channels 0 and 1). They accept amplifiers with:

- RS 422 or TTL 5 V inputs (negative logic).
- RS 422 or  $\overline{\text{NPN}}$  5 V NPN open collector outputs.

In a Modicon® Premium™ PLC configuration, the number of TSX CFY motion control modules should be added to the other application-specific modules (communication, counting, axis control and weighing).

### Description

The front panel of **TSX CFY 11/21** stepper control modules is comprised of:

- 1 One 15-way SUB-D connector per channel for connecting:
  - Amplifier inputs.
  - Amplifier outputs.
  - Amplifier input power supply.
- 2 One 20-way HE 10 connector for connecting:
  - Auxiliary inputs: per axis, homing cam, emergency stop, limit switches (+ and -), event, external stop.
  - Brake outputs (1 per axis).
  - External power supplies for sensors and preactuators.
- 3 Rigid casing which:
  - Holds the electronic card.
  - Locates and locks the module in its slot.
- 4 Module diagnostics lamps:
  - Module diagnostics:
    - green RUN lamp: module operating,
    - red ERR lamp: detected internal fault, detected module failure,
    - red I/O lamp: detected external fault.
  - Axis diagnostics:
    - 2 green CH● lamps: axis diagnostics available.

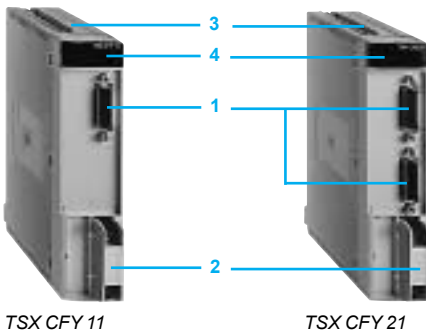

TSX CFY 11

TSX CFY 21



4

### Operation block diagram

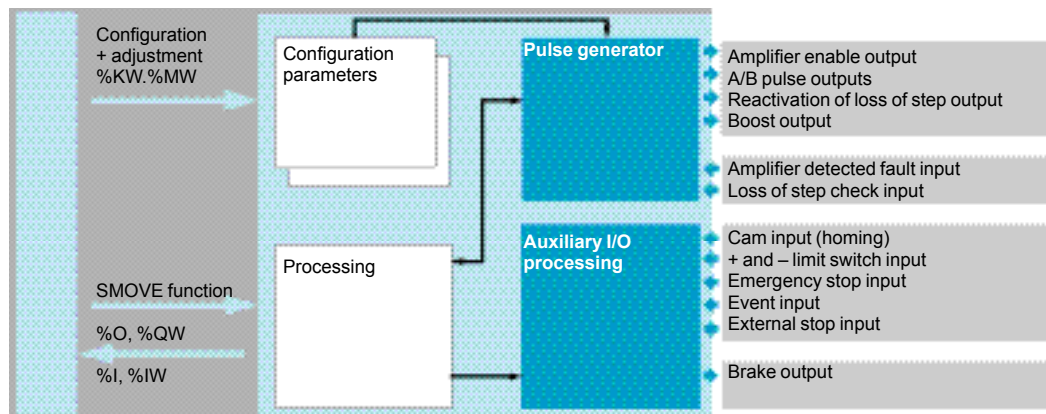

Operating characteristics are described on page 4/36

Stepper control modules are set up using Unity™ Pro or PL7™ Junior/Pro software.



Electrical characteristics				
Type of module		TSX™ CFY 11	TSX CFY 21	
Modularity		1 axis	2 axes	
Maximum pulse frequency	<b>kHz</b>	187.316	187.316	
Consumption	<b>mA</b>	See page 9/6		
Power dissipated in the module	<b>W</b>	3.8 typical	5.6 typical	
Sensor power supply check		Yes	Yes	
Input characteristics				
Inputs		Amplifier inputs	Auxiliary inputs	
Logic		Negative	Positive	
Nominal values	Voltage	<b>V</b>	5	
	Current	<b>mA</b>	4.5	
Limit values	Voltage	<b>V</b>	–	
	At state 1	Voltage	<b>V</b>	< 2
		Current	<b>mA</b>	–
	At state 0	Voltage	<b>V</b>	> 3.6
		Current	<b>mA</b>	–
Input impedance for nominal U		<b>kΩ</b>	–	
Input immunity		<b>μs</b>	Loss of step input: 15 to 30:	
		<b>μs</b>	–	
		<b>ms</b>	Amplifier detected fault input: 3 to 16	
Monitoring of external power supply for sensors and preactuators	Voltage for OK state	<b>V</b>	–	
	Voltage for detected fault state	<b>V</b>	–	
	Immunity OK → detected fault	<b>ms</b>	–	
	Immunity detected fault → OK	<b>ms</b>	–	
Type of input		Resistive	Current sink	
IEC/EN 61131 conformity		–	Type 2	
Sensor compatibility		–	2-wire/3-wire	
Output characteristics				
Outputs		Amplifier outputs	Brake outputs (1 per axis)	
Type of output		RS 422, TTL 5 V open collector NPN compatible	Open collector, PNP	
Output differential voltage		<b>V</b>	± 2 (load resistance ≤ 100 Ω)	
Short-circuit current		<b>mA</b>	< 150	
Permissible common mode voltage		<b>V</b>	≤ 7	
Permissible differential voltage		<b>V</b>	≤ 12	
Voltages	Nominal	<b>V</b>	–	
	Limit	<b>V</b>	–	
Currents	Nominal	<b>mA</b>	–	
	Leakage	<b>mA</b>	–	
	Maxi	<b>mA</b>	–	
Maximum voltage drop when ON		<b>V</b>	–	
Switching time		<b>μs</b>	–	
Compatibility with DC inputs		–	Any positive logic inputs with input resistance < 15 kΩ	
IEC/EN 61131-2 compliance		–	Yes	
Short-circuit check on each channel		–	One signalling bit per channel	
Protection against	Overloads and short-circuits	–	Via current limiter and thermal tripping (reactivated via program or automatically)	
	Channel overvoltage	–	Zener diode between outputs and – + 24 V	
	Polarity inversions	–	By diode reverse-mounted on supply	

### Operating characteristics

<b>Control</b>		Pulse, frequency from 0 to 187 kHz + and - outputs or +/- outputs and direction
<b>Paths</b>		Trapezoidal speed profile with minimum movement frequency
<b>Operating modes</b>	OFF	Module inactive
	DIR DRIVE	Module operating as pulse generator
	MAN	Motion controlled by operator: - visual control of movement - incremental movement
	AUTO	Movement sequence controlled by PLC program. Movements are described using a syntax similar to that of ISO language. Movements may be expressed in absolute or relative terms (in relation to either the current position or a home point). Operation is possible in "step-by-step" mode.
<b>Checks</b>	Environment	Amplifier, limits switches, Emergency stop
	Motion	Check correct execution by software position limits, loss of step
	Control	Check consistency of commands
	Parameters	Check validity of parameters
<b>Optional commands</b>		Boost, brake

4

### Connections

#### TSX™ CFY 11/21 stepper control module connections

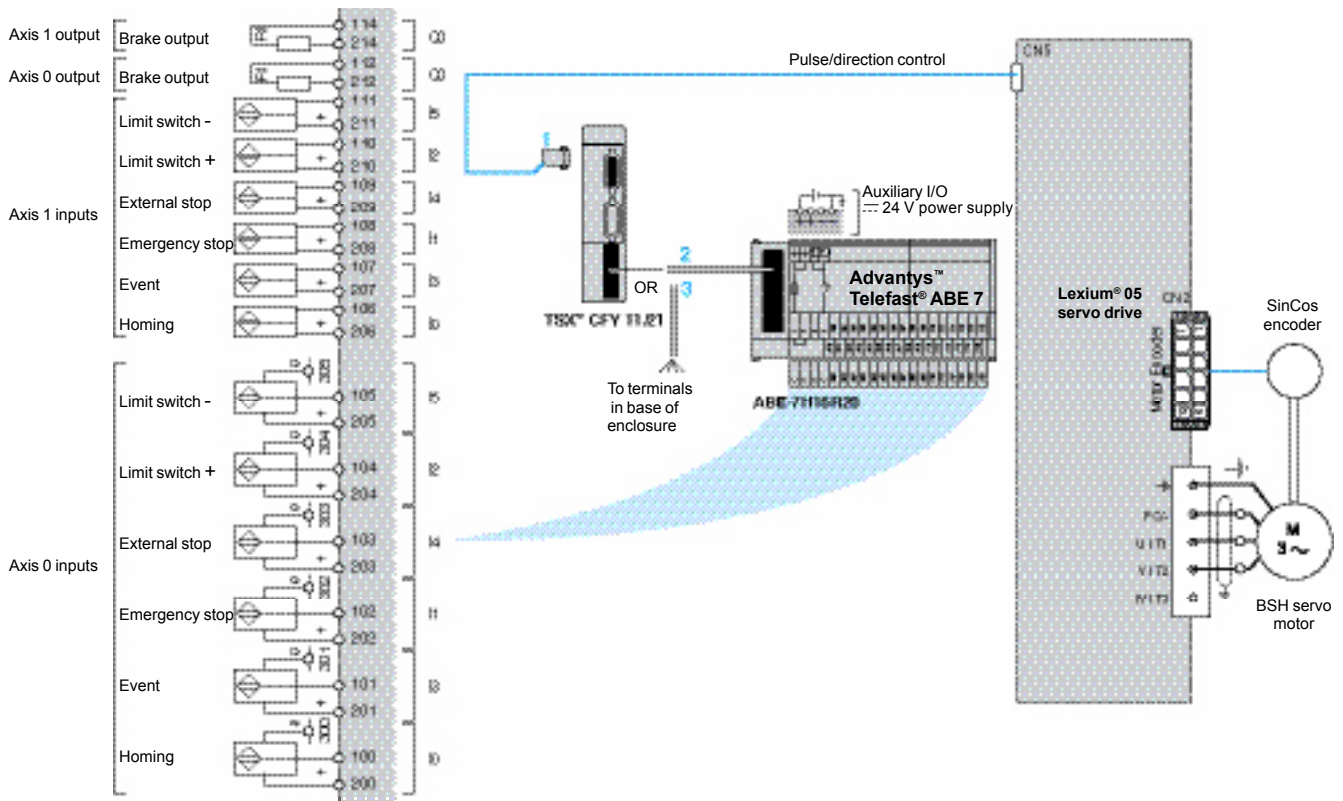

1 Cable with connectors **VW3 M8 204 R●●** (pulse/direction)

2 Cable with connectors **TSX CDP053/103/203/303/503/1003** (L = 0.5, 1, 2, 3, 5 or 10 m)

3 Cable with connector at one end and flying leads at the other **TSX CDP 301/501/1001** (L = 3, 5 or 10 m)

# Modicon® Premium™ automation platform

## TSX™ CFY 11/21 modules for stepper motors

### Motion control modules for stepper motors



TSX CFY 11



TSX CFY 21



ABE 7H16R20

Description	To control	Connections to connectors		No. of axes	Reference	Weight kg
		SUB-D, 15-way	HE 10, 20-way			
Motion control modules for stepper motors	Amplifier with RS 422 I/O, Inputs $\overline{\text{---}}$ 5 V TTL and outputs $\overline{\text{---}}$ 5 V with open collector	Amplifier I/O	Auxiliary I/O, $\overline{\text{---}}$ 24 V power supply	1	TSX™ CFY 11	0.440
				2	TSX CFY 21	0.480

#### Connection accessories

Description	TSX CFY ●1 connector	Type of connector on TSX CFY ●1 module	Unit reference	Weight kg
SUB-D connectors <i>Sold in lots of 2</i>	Amplifier	SUB-D, 15-way (1 per axis)	TSX™ CAP S15	0.050
Advantys™ Telefast® ABE 7 connection sub-base	Auxiliary I/O for axes 0/1, $\overline{\text{---}}$ 24 V power supply	HE 10, 20-way (1 for 2 axes)	ABE 7H16R20	0.300
Additional terminal block <i>Order in multiples of 5</i>	20 shunted terminals for ABE 7H16R20 sub-bases	–	ABE 7BV20	0.030

#### Connecting cables

Description	From module TSX CFY ●1	To	Rep. (1)	Length	Reference	Weight kg
Connection cables AWG 22 (0.324 mm <sup>2</sup> ) 500 mA max.	20-way HE 10 connector	ABE 7H16R20 sub-base (20-way HE 10 molded connector)	2	0.5 m	TSX™ CDP 053	0.085
				1 m	TSX CDP 103	0.150
				2 m	TSX CDP 203	0.280
				3 m	TSX CDP 303	0.410
				5 m	TSX CDP 503	0.670
				10 m	TSX CDP 1003	1.180
Preformed cables with flying leads AWG 22 (0.324 mm <sup>2</sup> ) 500 mA max.	20-way HE 10 connector	Auxiliary I/O for axes 0/1, 24 V $\overline{\text{---}}$ power supply (flying leads at I/O end)	3	3 m	TSX CDP 301	0.400
				5 m	TSX CDP 501	0.660
				10 m	TSX CDP 1001	1.310
Cables for servo drives	15-way SUB-D connector	Lexium 05 servo-drive (10-way Molex connector for CN5)	1	0.5 m	VW3 M8 204 R05	0,020
				1.5 m	VW3 M8 204 R15	0,030
				3 m	VW3 M8 204 R30	0,040
				5 m	VW3 M8 204 R50	0,050



TSX CDP ●03



TSX CDP ●01

(1) For key, see page 4/36

# Modicon® Premium™ automation platform

## TSX™ CAY motion control modules for servo motors

### Presentation

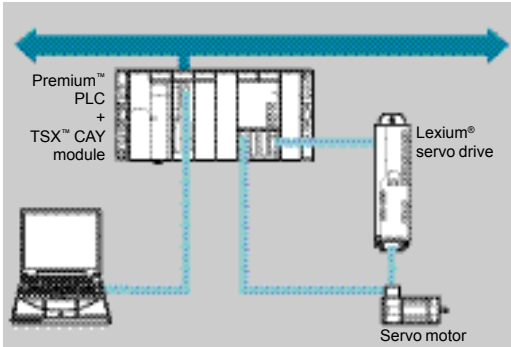

The servo-controlled TSX™ CAY●● positioning axis control offer is designed for machines requiring both high performance servo motion control in conjunction with PLC sequential control.

Depending on the model, the **TSX CAY ●●** modules make it possible to:

- Control 2 independent axes, **TSX CAY 21/22**
  - Control up to 4 independent axes, **TSX CAY 41/42**
  - Control 3 linearly interpolated axes, **TSX CAY 33**
- They accept servo drives with  $\pm 10$  V analog inputs including Lexium 05, Lexium 15 and Lexium 17D servo drives.

**TSX CAY ●●** modules can be inserted, like other application-specific modules, in any Modicon® Premium™ PLC slots.

### Description

4

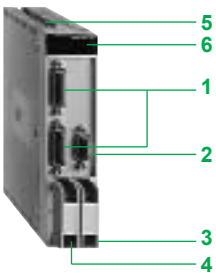

TSX CAY 21/22

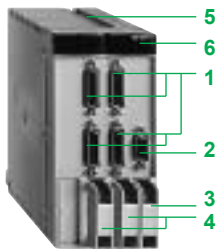

TSX CAY 41/42

On the front panel of the **TSX CAY ●●** axis control modules there is:

- 1 15-way SUB-D connector per axis for connection of an incremental or absolute encoder
- 2 9-way SUB-D connector for connecting an analog output "speed reference" for each axis
- 3 HE 10 to 20-way connector axis for connecting:
  - auxiliary servo drive control inputs
  - external power supply of servo drive inputs/outputs
- 4 HE 10 to 20-way connector for two axes (0/1 or 2/3) for connecting:
  - auxiliary inputs: homing cam, emergency stop, event, recalibration, and reflex outputs
  - external sensor and preactuator power supplies
- 5 Rigid casing that performs the functions of:
  - supporting electronic cards
  - attaching and locking the module in its slot
- 6 LEDs for module diagnostics:
  - at the module level:
    - Green RUN LED: module in operation
    - Red ERR LED: detected internal fault, module out of service
    - red I/O LED: detected external fault
  - at the axis level:
    - Green CH● LED: axis diagnostics present

TSX CAY 41/42

### Operation

#### Diagram of an axis

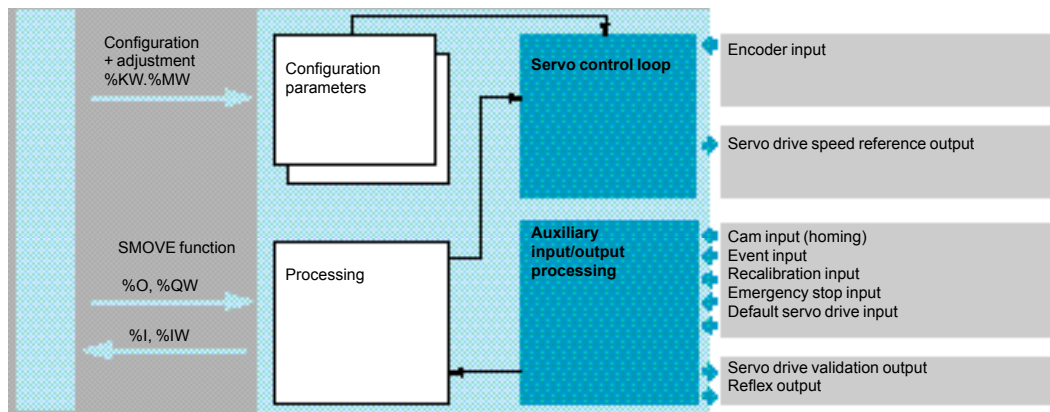

Axis control modules are set up using Unity™ Pro or PL7™ Junior/Pro software.

Premium **TSX™ P57 ●●3M/4M** slot PLCs are required for **TSX™ CAY 22/42/33** modules.

Functional characteristics				
Module type		TSX® CAY 21/22	TSX CAY 41/42	TSX CAY 33
Servo control loop	Period	ms	Proportional to overshoot compensation and gain switching	
			2	4
Paths	Speed profile	Trapezoid or parabolic		
Resolution	Minimum	0.5 position units per point		
	Maximum	1000 position units per point		
Length of axis	Minimum	TSX CAY 21: 32,000 points	TSX CAY 41: 32,000 points	TSX CAY 33: 256 points
	Maximum	TSX CAY 22: 256 points	TSX CAY 42: 256 points	
Speed	Minimum	54,000 points/min		
	Maximum	270,000 points/min		
Acceleration (Change from 0 to VMAX)	Minimum	s	10	
	Maximum	ms	8	16
Operating modes	OFF	Measuring mode, disabling of the servo control loop The module operates by acquiring the position and current speed		
	DIR DRIVE	Servo control is switched off, disabling of the servo control loop The module operates only in analog output		
	MAN	Motion control by an operator: - movement by viewing - incremental movement		
	AUTO	Sequence of movements controlled by a PLC program. The movements are described by a syntax similar to ISO language. The movements can be expressed absolutely or relatively (in relation to the current position or the captured position). Possibility of "step by step" execution, suspension/resumption of movement, changes in speed		
	FOLLOWER	Axis n of the module is servo controlled: - either at the 0 axis of the same module - or at a control profile transmitted by application program		-
Environment	Encoder coupling, servo drive present, emergency stop			
Movements	Control of the proper execution of movements (following difference, operational window, software stops)			
Control	Control consistency check			
Parameters	Parameter validity check			

Functionalities						
Module type		TSX® CAY 21	TSX CAY 22	TSX CAY 41	TSX CAY 42	TSX CAY 33
2/3 axes linear interpolation		-				Yes
Limited axes		Yes				
Infinite axes		-	Yes	-	Yes	
Following axes	Static ratio	Yes	-	Yes	-	
	Dynamic ratio	-	Yes	-	Yes	-
Servo drive offset correction		-	Yes	-	Yes	
Cut on the fly	On position or on event with infinite master axis and linearly-limited slave axis	-	Yes (1)	-		

(1) The TSX CAY 22 module's cut on the fly function requires Unity™ Pro software version ≥ 2.2 or PL7™ Junior/Pro software version u 4.1.

# Modicon® Premium™ automation platform

## TSX™ CAY motion control modules for servo motors

### Electrical characteristics

Module type		TSX™ CAY 21	TSX CAY 22	TSX CAY 41	TSX CAY 42	TSX CAY 33
<b>Modularity</b>		2 axes		4 axes		3 axes
<b>Maximum frequency on the counter inputs</b>	SSI absolute encoder	16 to 25 bits	12 to 25 bits	16 to 25 bits	12 to 25 bits	
	CLK frequency transmission	kHz 200				
	Incremental encoder x 1	kHz 500				
	x 4	kHz 250 kHz in input or 1 MHz in counting				
<b>Consumption</b>	5 V $\overline{--}$	mA 1100		1500		
	24 V $\overline{--}$	mA 15		30		
<b>Current consumed by module on the 10/30 V encoder at 24V (24 V absolute encoder)</b>		mA 11 typical, 20 max.		22 typical, 40 max.		
<b>Power dissipated inside the module</b>		W 7.2 typical, 11.5 max.		10 typical, 17 max.		
<b>Control of sensor power supplies</b>		Yes				

### Input characteristics

Type of input		Counter inputs 5 V $\overline{--}$ (IA/IB/IZ)	Servo drive control inputs (1 per axis)	Auxiliary inputs (homing, event, recalibration, emergency stop)	
<b>Logic</b>		Positive			
<b>Nominal values</b>	Voltage	V 5	24		
	Current	mA 18	8		
<b>Value limits</b>	Voltage	V $\leq 5.5$	19...30 (possible up to 34 V, limited 1 hour per 24 hours)		
	At state 1	Voltage	V $\geq 2.4$	$\geq 11$ (OK state)	$\geq 11$
		Current	mA $> 3.7$ (for U = 2.4 V)	$> 3.5$ (for U = 11 V)	$> 6$ (for U = 11 V)
	At state 0	Voltage	V $\leq 1.2$	$\leq 5$ (default state)	$\leq 5$
		Current	mA $< 1$ (for U = 1.2 V)	$< 1.5$ (for U = 5 V)	$< 2$ (for U = 5 V)
<b>Control of voltage/sensor feedback</b>		Presence check	-		
<b>Input impedance for nominal U</b>		$\square$ 270	3000		
<b>Type of input</b>		Resistive			
<b>Conforming to IEC/EN 61131</b>		-	Type 1	Type 2	
<b>Compatibility detectors</b>	2-wire	-	-	Yes (24 V detectors)	
	3-wire	-	-	Yes (24 V detectors)	

### Output characteristics

Type of output		Analog outputs (1 per axis)	Servo drive validation (1 relay output per axis)	Reflex outputs (1 per axis)
<b>Range</b>	V	$\pm 10, 24$	-	
<b>Resolution</b>		13 bits + sign	-	
<b>LSB value</b>	mV	1.25	-	
<b>Nominal voltage</b>	V	-	$\overline{--}$ 24	
<b>Voltage limit</b>	V	-	5...30	19...30 (possible up to 34 V, limited 1 hour per 24 hours)
<b>Current</b>	mA	-	500 nominal	
<b>Maximum current</b>	mA	1.5	200 (resistive charge under 30 V)	625 (for U = 30 or 34 V)
<b>Minimum permitted load</b>		-	1 V/1mA	-
<b>Max voltage drop ON</b>	V	-	$< 1$	
<b>Leakage current</b>	mA	-	$< 0.3$	
<b>Switching time</b>		-	$< 5$ ms	$< 500$ $\square$ s
<b>Compatibility with d.c. inputs</b>		-	Positive logic inputs for which the input resistance is $< 15$ k $\square$	
<b>Conforming to IEC/EN 61131</b>		-	Yes	
<b>Protections</b>	Short-circuit and overload	-	By current limiter and thermal release	
	Channel overvoltage	-	Zener diodes between the inputs and the + 24 V	
	Against reverse polarity	-	By diode in the opposite direction to the power supply	

# Modicon® Premium™ automation platform

TSX™ CAY motion control modules for  
servo motors

## Dimensions

TSX™ TAP S15 05 connection interface for incremental encoder

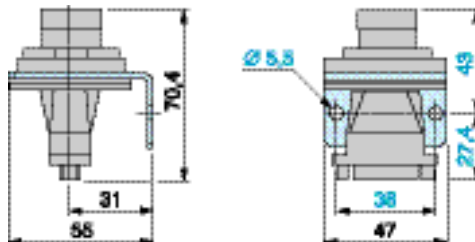

Mounting in enclosure feedthrough (dust and damp proof)

- Ø 37 cut-out,
- Panel thickness 5 mm maximum

TSX TAP MAS speed reference splitter block for speed drives

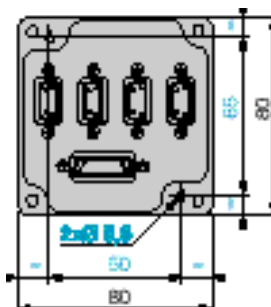

Mounting on DIN rail with LA9-DC9976 accessory.

# Modicon® Premium™ automation platform

## TSX™ CAY motion control modules for servo motors



TSX CAY 2●

TSX CAY 4●

Motion control modules for servo motors					
Type of input	Characteristics	Function	No. of axes (1)	Reference	Weight kg
Incremental encoders ⋮ 5 V RS 422, ⋮ 10...30 V Totem pole (2)	500 kHz counter with incremental encoder 200 kHz acquisition with absolute serial encoder	Servo control on independent linear axis	2	<b>TSX™ CAY 21</b>	0.480
			4	<b>TSX CAY 41</b>	0.610
Absolute encoders RS 485 serial or parallel (3)		Servo control on independent linear or independent infinite axis Following axes Servo drive realtime offset correction Cut on the fly (4)	2	<b>TSX CAY 22</b>	0.480
			4	<b>TSX CAY 42</b>	0.610
			3	<b>TSX CAY 33</b>	0.610
		Servo control on linear or infinite axis Linear interpolation on 2 or 3 axes Servo drive realtime offset correction			



TSX CAY 33

Connection elements					
Connection accessories					
Description	Connection	Type of connector on module TSX CAY ●●	Rep. (5)	Unit reference	Weight kg
<b>SUB-D connectors</b> Sold in lots of 2	SSI absolute/incremental encoder	15-way SUB-D (1 per axis)	4	<b>TSX™ CAP S15</b>	0.050
	Speed references	9-way SUB-D (1 per TSX CAY module)	7	<b>TSX CAP S9</b>	0.050
<b>Connection interface for incremental encoder</b>	Incremental encoder ⋮ 5 V RS 422/RS 485	15-way SUB-D (1 per axis)	6	<b>TSX™ TAP S15 05</b>	0.260
<b>Splitter unit</b>	Speed references towards servo drives	9-way SUB-D (1 per TSX CAY module)	—	<b>TSX TAP MAS</b>	0.590
<b>Advantys™ Telefast® ABE 7 connection bases</b>	Speed references	9-way SUB-D (1 per TSX CAY module)	—	<b>ABE 7CPA01</b>	0.300
	Auxiliary inputs, reflex outputs, I/O power supply ⋮ 24 V, encoder power supplies ⋮ 5/24 V	10, 20-way HE (1 for 2 axes)	—	<b>ABE 7H16R20</b>	0.300
	Servo drive control signals, I/O power supply ⋮ 24 V	10, 20-way HE (1 per TSX CAY module)	—		
<b>Additional terminal block</b> Order in multiples of 5	20 shunted terminals for ABE 7H16R20 sub-base	—	—	<b>ABE 7BV20</b>	0,060
<b>Adaptor base</b>	Absolute encoders with parallel outputs (16 to 24 bit) ⋮ 5 V, ⋮ 10...30 V	15-way SUB-D	—	<b>ABE 7CPA11</b>	0.300



TSX TAPS15 05



TSX TAP MAS



ABE 7CPA01



ABE 7H16R20

(1) Double format **TSX CAY 41/42/33** modules.  
 (2) Totem pole encoder with supplementary Push/Pull outputs.  
 (3) Parallel output absolute encoders with **ABE 7CPA11** adaptor interface.  
 (4) Cut on the fly function available with **TSX CAY 22** module. Requires Unity™ Pro software version ≥ 2.2 or PL7™ Junior/Pro software version ≥ 4.1  
 (5) Diagram references, see page 4/43.



# Modicon® Premium™ automation platform

## TSX™ CAY motion control modules for servo motors



TSX CCP S15 ●●●

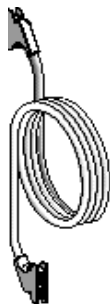

TSX CDP ●●3

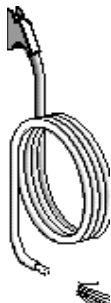

TSX CDP ●01

### Connection elements (continued)

#### Cables

Description	Use		Rep. (1)	Length	Reference	Weight kg	
	From	To					
<b>Cordsets</b> AWG 12 (0.205 mm <sup>2</sup> )	TSX™ CAY●● module, 15-way SUB-D connector	TSX™ TAP S15 05 interface or ABE 7CPA11 adaptor base (15-way SUB-D connector)	5	0.5 m	<b>TSX™ CCP S15 050</b>	0.110	
					1 m	<b>TSX CCP S15 100</b>	0.160
					2.5 m	<b>TSX CCP S15</b>	0.220
	TSX CAY●● module, 9-way SUB-D connector (speed reference)	ABE 7CPA01 sub-base or TSX TAP MAS splitter unit (15-way SUB-D connector)	8	2.5 m	<b>TSX™ CXP 213</b>	0.270	
			6 m	<b>TSX CXP 613</b>	0.580		
<b>Preformed cable</b> AWG 14 (0.205 mm <sup>2</sup> )	TSX CAY ●● module, or TSX TAP MAS unit (9-way SUB-D connector)	Lexium® 05/15/17D servo drive speed reference or other drives (free end)	9	6 m	<b>TSX™ CDP 611</b>	0.790	
<b>Connecting cables</b> AWG 22 (0.324 mm <sup>2</sup> ) 500 mA max.	TSX CAY ●● module, (20-way HE 10 connector)	ABE 7H16R20 sub-base (20-way HE 10 connector)	10	0.5 m	<b>TSX CDP 053</b>	0.085	
				1 m	<b>TSX CDP 103</b>	0.150	
				2 m	<b>TSX CDP 203</b>	0.280	
				3 m	<b>TSX CDP 303</b>	0.410	
				5 m	<b>TSX CDP 503</b>	0.670	
10 m	<b>TSX CDP 1003</b>	1.180					
<b>20-wire pre-formed cables</b> AWG 22 (0.324 mm <sup>2</sup> ) 500 mA max.	TSX CAY ●● module, (20-way HE 10, moulded connector)	Auxiliary inputs, reflex output, control signals, power supplies (free end with color-coded wires)	11	3 m	<b>TSX CDP 301</b>	0.400	
				5 m	<b>TSX CDP 501</b>	0.660	
				10 m	<b>TSX CDP 1001</b>	1.210	
<b>Codsets equipped for Lexium® 15 servo drives</b>	TSX CAY ●● module, 15-way SUB-D connector (encoder input)	Simulated incremental encoder feedback (9-way SUB-D connector)	12	2 m	<b>TSX CXP 235</b>	0.210	
				6 m	<b>TSX CXP 635</b>	0.470	
		Simulated absolute encoder feedback (9-way SUB-D connector)	13	2 m	<b>TSX CXP 245</b>	0.210	
				6 m	<b>TSX CXP 645</b>	0.470	

(1) Diagram references, see page 4/44 and 4/45.

### Connections for TSX™ CAY modules

#### General connections

##### Examples of encoder connections

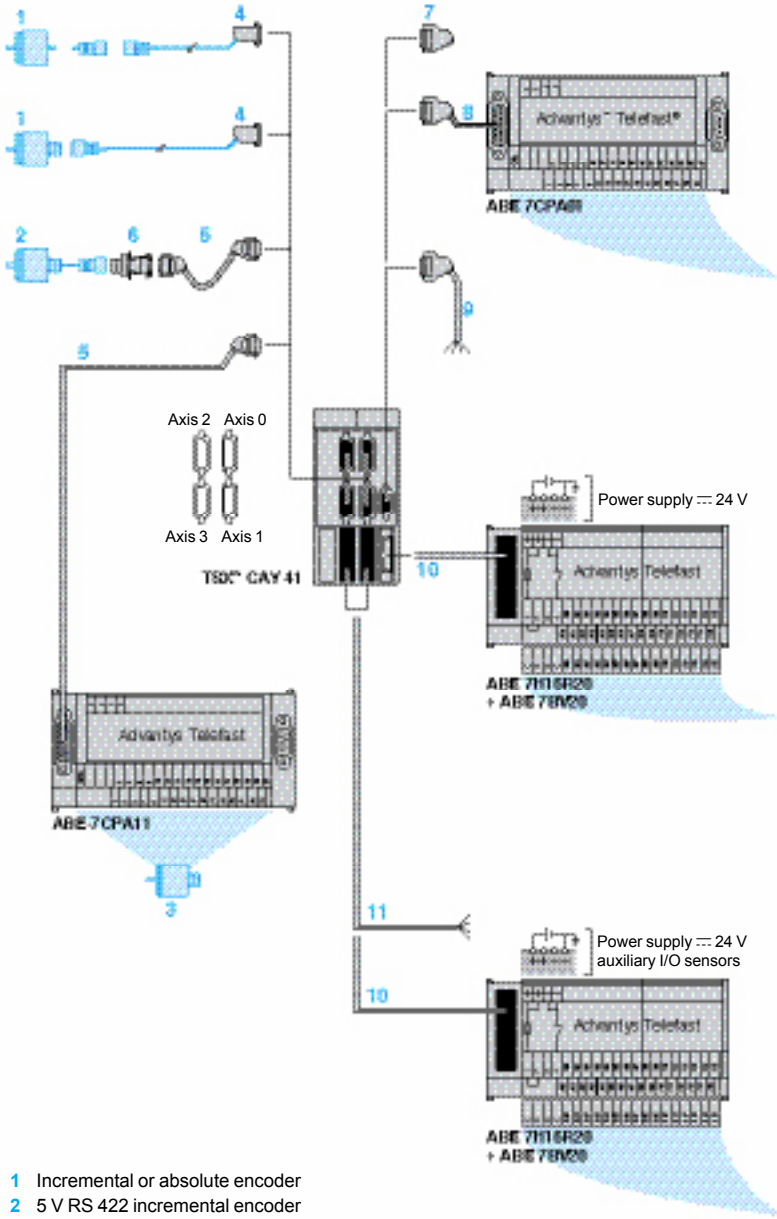

- 1 Incremental or absolute encoder
- 2 5 V RS 422 incremental encoder
- 3 Parallel output absolute encoder
- 4 TSX™ CAP S15 connector
- 5 TSX™ CCP S15 cable with connectors
- 6 TSX™ TAP S15 05 connector

TSX TAP S15 05		
1 IB-	7 NC	
2 Sup. Ret.	8 IB + 5 V	
3 IZ + 5 V	9 NC	
4 IZ -	10 0 V	
5 IA + 5 V	11 NC	
6 IA -	12 +5 V	

- 7 TSX CAP S9 connector
- 8 TSX™ CXP 213/613 cable with connector
- 9 TSX™ CDP 611 preformed cable with connector
- 10 TSX™ CDP cable with connector
- 11 TSX CDP preformed cable with connector

##### Examples of speed reference signal connections

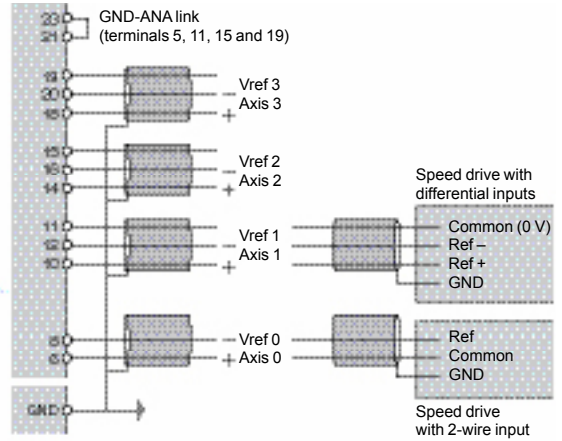

##### Example of speed drive connection (auxiliary I/O)

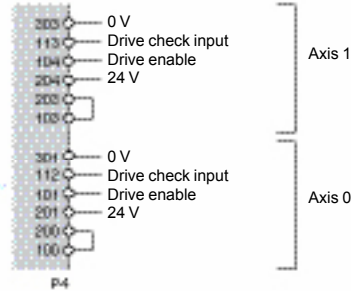

##### Example of auxiliary I/O connection

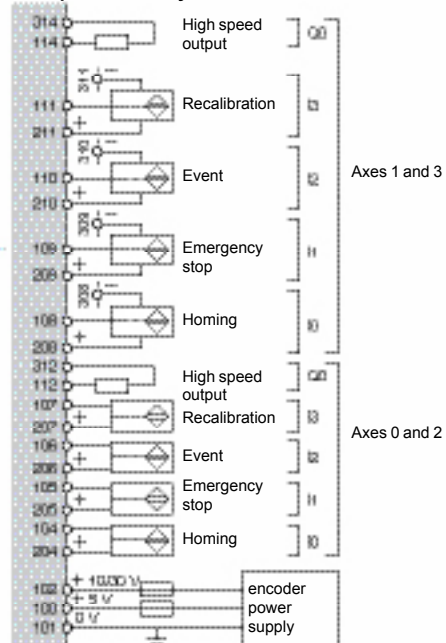

4

# Modicon® Premium™ automation platform

## TSX™ CAY motion control modules for servo motors

**Example of Lexium® 15 servo drive connection for BDH/BSH servo motor**

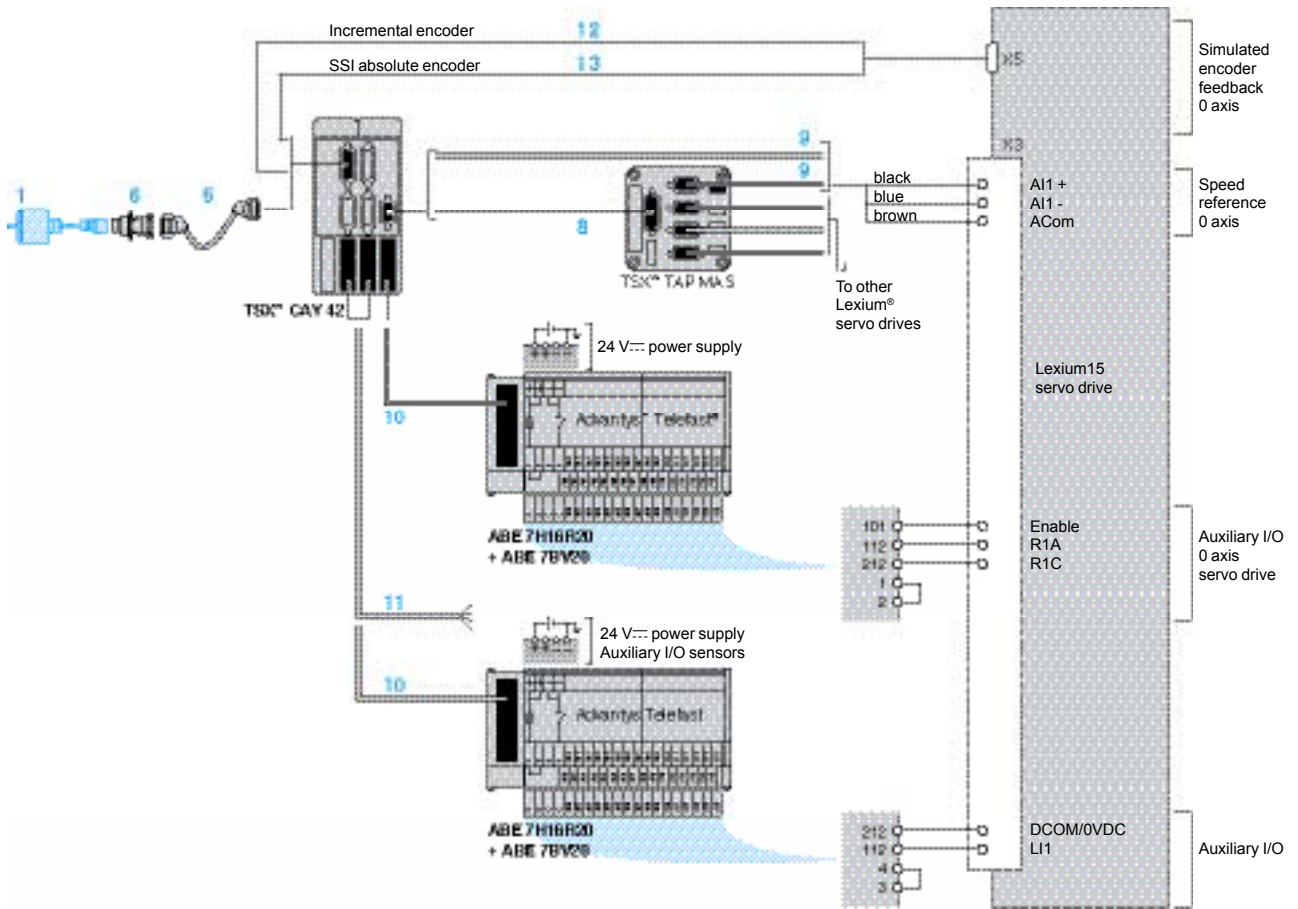

- |   |                                       |   |
|---|---------------------------------------|---|
| 1 Absolute/incremental encoder                      | 8 TSX™ CXP 213/613 fitted cordset     | 12 TSX CXP 235/635 fitted cordset (simulated incremental encoder feedback)  |
| 5 TSX™ CCP S15●●● fitted cordset (encoder feedback) | 9 TSX™ CDP 611 fitted cable           | 13 TSX CXP 245/645 fitted cordset (simulated SSI absolute encoder feedback) |
| 6 TSX™ TAP S15 05 connector                         | 10 TSX CDP●●3 fitted connecting cable |   |
|   | 11 TSX CDP●01 fitted pre-formed cable |   |

# Modicon® Premium™ automation platform

## Lexium® 15

### SERCOS™ TSX™ CSY 84/85/164 motion control modules

Presentation

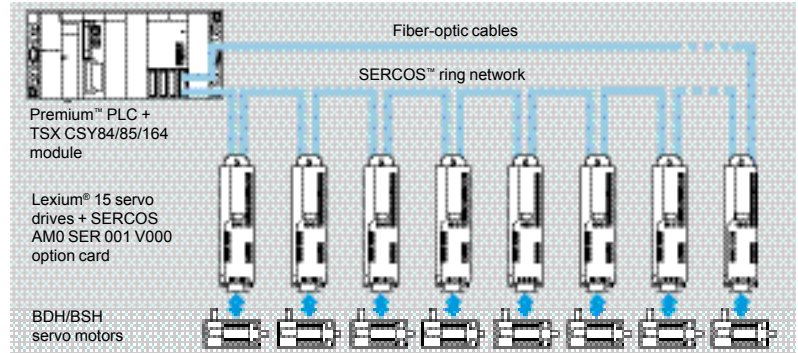

SERCOS™ (SERial Communication System) is a communication standard which defines the digital link (exchange protocol and medium) between a motion control module and servo drives. This is defined in European standard IEC/EN 61491. The use of SERCOS distributed architecture allows application I/O (position encoder, emergency stop, etc.) to be connected directly to the servo drives, thus reducing connection costs. The fiber-optic digital link permits high speed exchanges (2 or 4 Mbps) while helping to ensure a high level of immunity in disturbed industrial environments.

The SERCOS range in the Modicon® Premium™ automation platform consists of:

- TSX™ CSY 84/85/164 axis control modules (1) which can each control up to 8 servo drives (TSX CSY 84/85) and 16 servo drives (the TSX CSY 164) via a SERCOS ring. The module calculates the path and the interpolation for several axes (position mode). Access to the other modes (speed and torque) is possible with the assistance of Schneider Electric application services.

- 1.5 A to 70 A permanent Lexium® 15 servo drives (equipped with SERCOS option card). The servo drives manage the position loop, speed loop and torque loop, and to help ensure power conversion to control the servo motor. The sensor feedback information is sent to the servo drive (current position, current speed)

- BDH and BSH servo motors. The motors feature permanent magnets delivering a high power-to-weight ratio, resulting in excellent dynamic speed response in a compact unit.

The Lexium range offers the accessories required (line chokes, braking resistors, etc.) as well as a full set of connectors.

(1) The TSX CSY 85 module also supports path functions using the TJE path editor software.

System overview

The system overview presents the various functions performed by the different parts of the multi-axis control system.

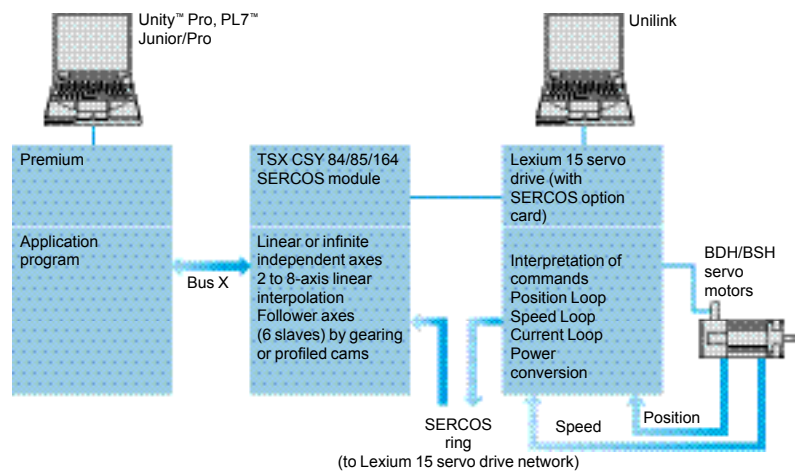

# Modicon® Premium™ automation platform Lexium® 15 SERCOS™ TSX™ CSY 84/85/164 motion control modules

## System overview (continued)

PL7™ Junior/Pro or Unity™ Pro software via the Premium™ platform terminal port can be used to:

- Declare SERCOS™ TSX™ CSY 84/85/164 modules in the PLC configuration.
- Configure the functions and define the parameters for the axes used.
- Program the movements in the PLC application.
- Adjust the parameters via the operating codes (parameters, TSX CSY module and Lexium® 15 servo drive with SERCOS option card).
- Test and debug the application.

Unilink software, via the Lexium 15 servo drive's RS 232 terminal port (with SERCOS option card) can be used to:

- Define types of Lexium 15 servo drive (with SERCOS option card) and BDH/BSH servo motor.
- Adjust the parameters for Lexium 15 servo drives (with SERCOS option card), back them up in the servo drive EEPROM memory and save them on a compatible PC.

## Description

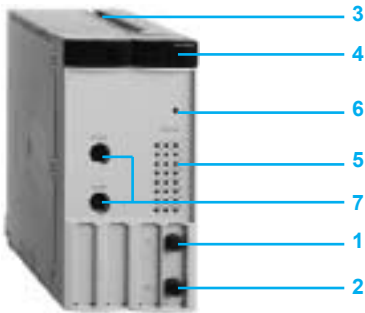

TSX CSY 84/164

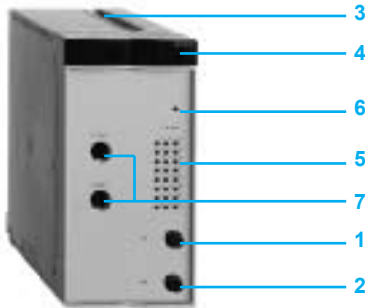

TSX CSY 85

The TSX CSY 84/85/164 SERCOS axis control modules are comprised of:

- 1 An SMA-type connector, marked TX, for connecting the servo drives using the SERCOS ring fiber-optic transmission cable.
- 2 An SMA-type connector, marked RX, for connecting the servo drives using the SERCOS ring fiber-optic reception cable.
- 3 Double format rigid casing, in order to:
  - Support electronic cards.
  - Attach and lock the module in its slot.
- 4 Module diagnostics LEDs:
  - RUN LED (green): LED ON indicates module operating correctly.
  - SER LED (yellow): flashing LED indicates data transmission and reception on the SERCOS network.
  - ERR LED (red):
    - LED ON indicates detected internal module fault
    - flashing LED on module start-up indicates detected communication fault, incompatible configuration or application missing.
  - I/O LED (red): LED ON indicates detected external or application fault.
  - INI LED (yellow): flashing LED indicates module reinitializing.
- 5 Channel diagnostic LEDs (green): LED ON indicates axis operating normally; OFF: detected configuration fault; flashing: serious detected error on axis:
  - 1 to 8: display of 8 real axes (1).
  - 9 to 12: display of 4 imaginary axes (1).
  - 13 to 16: display of 4 remote axes (1).
  - 17 to 20: display of 4 coordinated sets.
  - 21 to 24: display of 4 follower sets.
- 6 A pencil point button to reinitialize the module.
- 7 Two mini DIN type 8-way connectors for Schneider Electric use.

(1) 1 to 16: display of 16 axes (real, imaginary or remote) with module TSX CSY 164.

# Modicon® Premium™ automation platform Lexium® 15 SERCOS™ TSX™ CSY 84/85/164 motion control modules

4

Electrical characteristics		TSX™ CSY 84	TSX CSY 85	TSX CSY 164
<b>Module type</b>		TSX™ CSY 84		
<b>SERCOS network</b>	Type	Industrial support complying with standard IEC/EN 61491		
	Topology	Ring		
	Medium	Fiber-optic cable		
	Rate	4 Mbps by default		
	Cycle time (1) (independent axes)	2 axes	4 axes	8 axes
		ms	2	2
	Max. number of segments	9		17
	Length of segment	m		
		38 max. with plastic fiber-optic cable, 150 max. with glass fiber-optic cable		
<b>Bus X</b>	Distance	m		
		100 max. (2) between TSX CSY 84/85/164 axis control module and Premium processor		
<b>SERCOS™ certification</b>		TSX CSY 84/164 modules comply with SERCOS IEC/EN 61491 certification and with the tests defined by IGS (SERCOS Interest Group). Certification no. Z00030		
<b>Power consumption for 5 V <math>\overline{\text{v}}</math> voltage</b>		A		
		1.8		
<b>Power dissipated in the module</b>		W		
		9 (typical)		

Electrical characteristics		TSX CSY 84	TSX CSY 85	TSX CSY 164
<b>Module type</b>		TSX CSY 84		
<b>Number of channels</b>		32 configurable (0 to 31), channel 0 used for SERCOS ring configuration		
<b>Type of axes</b>	Real axes (connected to a servo drive)	8 (channels 1 to 8)		16 (channels 1 to 16) may be dynamically configured as real axes, imaginary axes or external encoders
	Imaginary axes	4 (channels 9 to 12)		
	Remote axes (3)	4 (channels 13 to 16)		
<b>Set of axes</b>		4 coordinated (channels 17 to 20) Each set allows simple linear interpolation of 2 to 8 axes		
		4 followers (channels 21 to 24). Each set can have up to 7 axes: 1 master/6 slaves in gearing or camming mode		
<b>Cam profile</b>		7 (channels 25 to 31). Used to create the electronic cams with linear or cubic interpolation between profile points		
<b>Path functions</b>		Simple linear paths, following of auxiliary axes	Linear paths: - with 3° or 5° polynomial links. - with circular link on 2 axes. Circular path TjE path editor software for sets of 2 or 3 axes	Simple linear paths, following of auxiliary axes

(1) 4 ms default value. Values may be programmed according to number of axes.  
 (2) Without the use of the **TSX REY 200** bus X remote module.  
 (3) Determine external position using an encoder connected to the servo drive position input.

# Modicon® Premium™ automation platform Lexium® 15 SERCOS™ TSX™ CSY 84/85/164 motion control modules

## Main functions of TSX™ CSY 84/85/164 modules

<b>Programming</b>	Movements	Homing, absolute, relative, or continuous Immediate movement, or queued, to a given position Speed override possible Acceleration and deceleration parameters may be set for each axis motion control Synchronization on start or resynchronization on stop for a slave axis on a master axis in a given position Rollover counter
	Special functions	Position capture and distance measurement between two edges on one or two logic inputs on the servo drive. This can be applied to the real or remote axis (position measurement via external sensor) Count probe: counts the edges on a logic input on the servo drive over a period of time Fast index: starts a movement on an event Registration move: position capture on an edge of the logic input on the servo drive Rotary knife: cuts using a rotary knife. Synchronizes a circular axis on a linear axis and controls a logic output on the servo drive
	Other special functions	It is possible to develop other special functions with the assistance of our application services. Please consult your Schneider Electric Regional Sales Office.
	Stop/start functions	Fast stop, stop on configured deceleration profile Temporary stop Restart of stopped movement Choice of stop method: <ul style="list-style-type: none"> <li>■ on inoperative slave: master is not stopped. Master stops normally according to pre-determined deceleration ramp or servo-driven master emergency stop</li> <li>■ on inoperative master: slave stops normally according to pre-determined deceleration ramp or servo-driven slave emergency stop</li> </ul> On Emergency Stop: calculation of slave axis deceleration ramp alignment with master axis to obtain synchronized stopping of the axes in the set On Emergency Stop: axes may be allowed to "freewheel" or may be stopped according to a pre-determined ramp
<b>Configuration and adjustment</b>	SERCOS™ ring	Bus cycle time, traffic on the bus, optical power on the fiber, SERCOS loop diagnostics
	Acceleration/deceleration	Ramp values, ramp type (rectangular, triangular and trapezoid), choice of units, maximum acceleration adjustment
	Speed	Speed units, default speed, maximum speed, speed override
	Other settings	Target window, rollover, software limits
	Set of follower axes	Following of master axis by gearing or camming (cam profile), threshold position of master triggers the following, bias value when synchronizing an axis, monitoring of master/slave positions, master offset for follower axis
	Set of coordinated axes	Type of interpolation: linear
	Cam profile	Value of an existing point of a cam profile, number of points (5000 max.), type of interpolation, table addresses
	State of a movement or axis	Moving, accelerating, decelerating, homing, in position, fault detected, etc.
	Diagnostics	Servo drive fault detected, axis currently reading data, detected following error, overvoltage, undervoltage, overcurrent, power supply inoperative Availability of follower axis detected fault information for a given axis set Multi-axis motion path control according to common tolerance for the axes in the motion, with alarm feature. Only available with the TSX™ CSY 164 module



## Functions specific to the TSX™ CSY 85 module

### Path creation using TJE editor

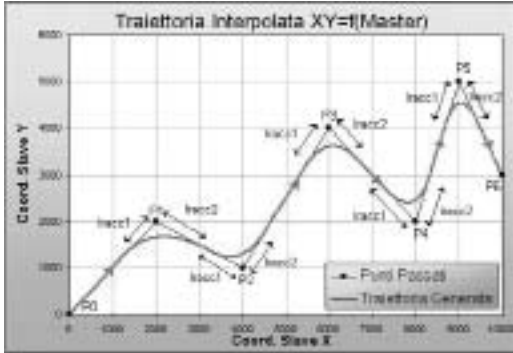

The paths, whether simple or complex, are divided into linear or circular segments linked by interpolation laws of 6 possible types. Each segment is characterized by:

- The X and Y coordinates of the point to be reached (in the example on the left, P6) or "tangented" (P1, P2,...P5)
- The movement speed, maximum or limited according to setpoint (parameter "ParF0", see screens below):
  - The type of interpolation (parameter "ParW0", see screens below)
  - The number of points in the linear segment (min. 1 point)
  - The number of points in the cubic interpolation part of the segment
  - Various other parameters depending on the type of interpolation

### Linear interpolation

P1		
X Coord	30	
Y Coord	0	
ParF0 (V/s)	0	
ParW0	0	Interpolation linéaire
ParW1	1	Nombre de points dans la section lin
ParW2	0	
ParW3	0	
ParW4	0	
ParF1	0	
ParF2	0	
ParF3	0	

This type of interpolation is used to create a rectilinear path between the preceding point  $P^{i-1}$  and point  $P_i$  defining the segment. The various parameters below are used as follows:

- "ParW1" indicates the number of points in the linear segment. The number of points represents the number of intermediate points that the TSX CSY 85 motion control module must calculate to define the path on the segment (minimum 1).
- "ParW4" is used to indicate that the movement of a third axis will follow the path (here, the linear segment) using tangential mode: positioning according to a constant angle with the path (1).

(1) Available in the future version of the TJE software.

### Linear interpolation with 3° polynomial interpolation connection

P1		
X Coord	3	
Y Coord	6	
ParF0 (V/s)	-1	
ParW0	1	Linear Int. with 3° Poly./Cubic Conn
ParW1	1	No. Points in linear section
ParW2	10	No. Points Cubic Conn. Section
ParW3	100	W- Shape Coefficient
ParW4	0	
ParF1	1	Inacc1: Initial Connection Length
ParF2	2	Inacc2: Final Connection Length
ParF3	0	

This type of interpolation is used to create a curve between two linear segments in accordance with a 3° interpolation in order to smooth the transitions. The path no longer passes through the defined point  $P_i$  (in the example on the left, P1) but follows a curve defined by the following parameters:

- "ParW2" indicates the number of points in the cubic interpolation part (curve)
- "ParW3" defines the shape coefficient of the cubic interpolation enabling the curve to move closer to or further from the defined point  $P_i$
- "Inacc1" and "Inacc2" correspond to the initial and final connection lengths. If these lengths are too great, maximum lengths are calculated by the TSX CSY 85 motion control module as a function of the previous section for Inacc1 and of the following section for Inacc2.

### Linear interpolation with 5° polynomial interpolation connection

P1		
X Coord	3	
Y Coord	6	
ParF0 (V/s)	-1	
ParW0	2	Linear Int. with 5° Poly. Connection
ParW1	1	No. Points in linear section
ParW2	10	No. Points Conn. Section
ParW3	100	W- Shape Coefficient
ParW4	0	
ParF1	1	Inacc1: Initial Connection Length
ParF2	1.5	Inacc2: Final Connection Length
ParF3	0	

The type of 5° polynomial interpolation is used to define a path in the same way as that using 3° polynomial interpolation.

Nonetheless, compared to a 3° interpolation, 5° interpolation helps to ensure more flexible movement.

If the acceleration limit in the segment in question is reached, however, the speed on the segment can be reduced for this type of connection.

### Linear interpolation with circular interpolation connection

P0		
X Coord	5	
Y Coord	6	
ParF0 (V/s)	-1	
ParW0	10	Linear Int. with Circular Connection
ParW1	1	No. Points in linear section
ParW2	10	No. Points Circular Conn. Section
ParW3	0	
ParW4	0	
ParF1	3	Circular Connection Length
ParF2	0	
ParF3	0	

This type of interpolation is used to link segments via a circular path (circle arcs or full circles). The specific parameters defining this type of path are:

- "ParW2" indicates the number of points in the circular interpolation part
- "ParW4" defines whether the arc is greater or less than 180° (defining the arc direction)
- "ParF1" corresponds to the length of the circular interpolation segment

Circular interpolation is only possible for a movement in a plane involving only 2 axes.



**Functions specific to the TSX™ CSY 85 module (continued)**

**Circular interpolation according to radius**



This type of interpolation is used to connect segments via a circular path (circle arcs) by specifying the start and end points, the circle radius and the path direction (clockwise or counter-clockwise). The specific parameters defining this type of path are:

- "ParW1" indicates the number of points in the circle arc
- "ParW4" defines the path direction (clockwise or counter-clockwise)
- "ParF1" corresponds to the radius of the circle arc

**Circular interpolation according to radius:**

- Is only possible for a movement in a single plane (2 axes only)
- Cannot be used to create paths in a full circle (to do this, use linear interpolation with connection according to circular interpolation)

**Circular interpolation according to center**

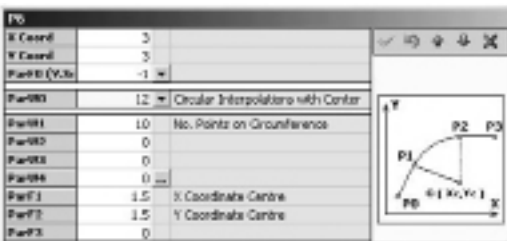

This type of interpolation is also used to connect segments by a circular path (circle arcs or full circles) by specifying the start and end points, the circle center coordinates and the path direction (clockwise or counter-clockwise). The specific parameters defining this type of path are:

- "ParW1" indicates the number of points in the circle arc
- "ParW4" defines the path direction (clockwise or counter-clockwise)
- "ParF1" indicates the abscissa of the center of the circle (X)
- "ParF2" indicates the ordinate of the center of the circle (Y)

Full circular movement is defined as the end point being the same as the start point. Circular interpolation is only possible for a movement in a single plane (2 axes only).

**Tangential axis interpolation**

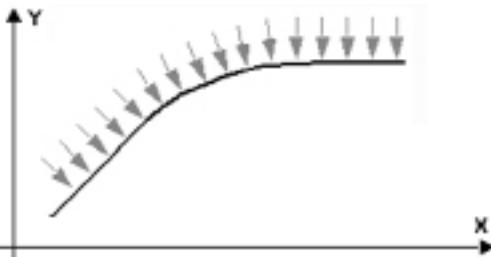

Tangential axis interpolation applied to a third angular axis is used to enable it to follow the path defined by the first two axes according to a constant, controlled angle. Tangential mode will be fully available in a future version.

This version V1.0 of the TSX™ CSY 85 module, however, offers functions for creating tangential mode using the PL7™ application.

**TJE path editor software**

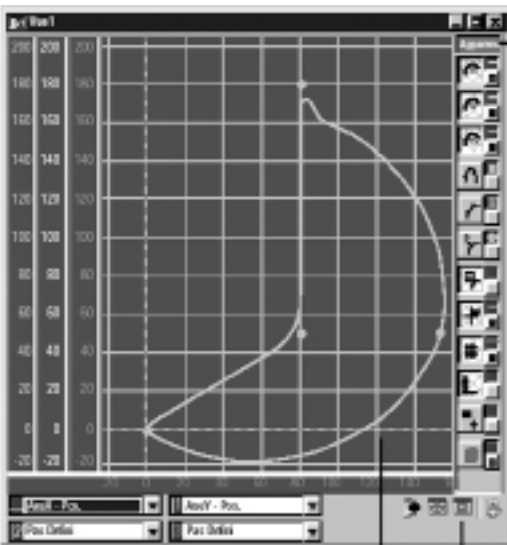

The TJE path editor software supplied with the SERCOS™ TSX™ CSY 85 motion control module is used in offline mode to:

- Create master/slave axes and axis sets for use in the paths with a maximum of 3 sets of 2 real axes or 2 sets of 3 axes.
- Each slave axis requires a cam profile selected from the 7 profiles available in the TSX CSY 85 module (with a limit of 10,000 cam points for the profiles).
- Define paths by setting the parameters for each segment which are linked to the various possible interpolations described in pages 4/50 and 4/51 of this catalog.
- The TJE software validates the parameters and calculates the paths for each set of axes.

**Path display**

The TJE software integrates different graphic tools for displaying the previously created paths and the relevant data linked to the axes (making up the paths) with their positions, speeds or accelerations. The paths can be displayed with:

- A choice of curves, colors and scaling
- A choice of scales and offsets
- Display of segment reference points
- Display of points of the master, and calculated points of cam profiles

This display enables the user to validate the paths before transferring the data thus generated to the PL7 Junior/Pro application managing the SERCOS TSX CSY 85 motion control module(s).

(1) Maximum 8 real axes per TSX CSY 85 module.

# Modicon® Premium™ automation platform

## Lexium® 15

### SERCOS™ TSX™ CSY 84/85/164 motion control modules

#### Software setup of TSX™ CSY 84/85/164 modules



Module configuration

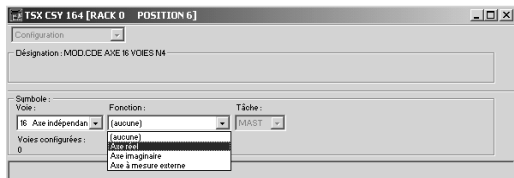

Declaring the axes of the TSX CSY 164 module



Setting the axis parameters

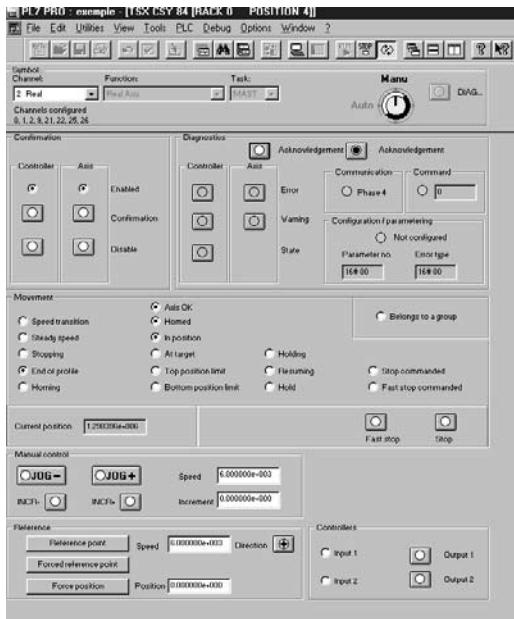

Debugging in PL7 Pro software

When setting up application-specific functions, screens specific to SERCOS™ motion control functions can be accessed via Unity™ Pro or PL7™ Junior/Pro software, for configuration, adjustment, debugging and documentation of applications. These services are performed by editors which can be directly accessed from the basic screen using icons in the tool bars. Windows relating to the editors can be simultaneously displayed on one screen (example: it is possible to program using the program editor and to simultaneously define the symbols in the variables editor).

#### Declaring the SERCOS motion control modules

Parameter entry for application-specific functions is accessed via the configuration screen, by clicking on the slot occupied by the module.

#### Configuring the module

The configuration editor provides assistance with entering and modifying the values of the various axis configuration parameters. These parameters help to enable the operation of the axis control module to be adapted to the machine to be controlled.

The axis configuration parameters are:

- Units of measurement
- Resolution
- Maximum and minimum limit positions
- Maximum speed
- Accelerating/decelerating

This data relates to the machine and cannot be modified by the program.

The configuration screen as shown here can be used to declare the 16 axes as real, imaginary or remote measurement axes in the TSX™ CSY 164 module.

#### Adjusting the modules

These parameters are associated with operation of the axes. They generally require the operations on and movements of the moving part to be known. These parameters are adjusted in online mode (they are initialized during configuration, in offline mode).

They concern:

- Maximum speed
- Resolution
- Servo control parameters
- Accelerating/decelerating

#### Debugging the modules

In online mode, the debugging tool provides the user with a control panel screen, giving a quick display which can be used to control and observe the behaviour of the axis.

The TSX CSY 84/85/164 modules associated with the Unity Pro or PL7 Junior/Pro software provides manual mode for running continual (JOG) or incremental (INC) motion commands without prior programming.

# Modicon® Premium™ automation platform Lexium® 15 SERCOS™ TSX™ CSY 84/85/164 motion control modules

## References (1)

TSX™ CSY 84/85/164 multi-axis control modules have 32 application-specific channels which are only counted when they are configured in the Modicon® Premium™ PLC application (using PL7™ Junior/Pro or Unity™ Pro software). The maximum number of application-specific channels allowed depends on the type of processor:

Type of processor or slot PLC	TSX™ 57 1●	TSX 57 2● PCX 57 20 PCI 57 20	TSX 57 3● PCX 57 35 PCI 57 35	TSX 57 4●	TSX 57 5●
Max. number of application-specific channels	8	24	32	64	64

### Motion control modules

Description	Function	Number of axes	Reference	Weight kg
Multi-axis control modules	SERCOS™ digital servo drives control	8 real axes 4 imaginary axes 4 remote axes	TSX CSY 84	0.520
		8 real axes 4 imaginary axes 4 remote axes TjE path creation function	TSX CSY 85	0.520
		16 axes (real, imaginary or remote)	TSX CSY 164	0.520

### Fiber-optic connection cables

Description	Connection	Length	Reference	Weight kg
Plastic fiber-optic cables fitted with SMA-type connectors (curvature radius: 25 mm min.)	Lexium® 15 servo drive (with SERCOS option card)	0.3 m	990 MCO 000 01	0.050
		0.9 m	990 MCO 000 03	0.180
		1.5 m	990 MCO 000 05	0.260
		4.5 m	990 MCO 000 15	0.770
		16.5 m	990 MCO 000 55	2.830
		22.5 m	990 MCO 000 75	4.070
		37.5 m	990 MCO 001 25	5.940



TSX CSY 84/164



TSX CSY 85

## Connections

### SERCOS ring with five Lexium® 15 servo drives (example)

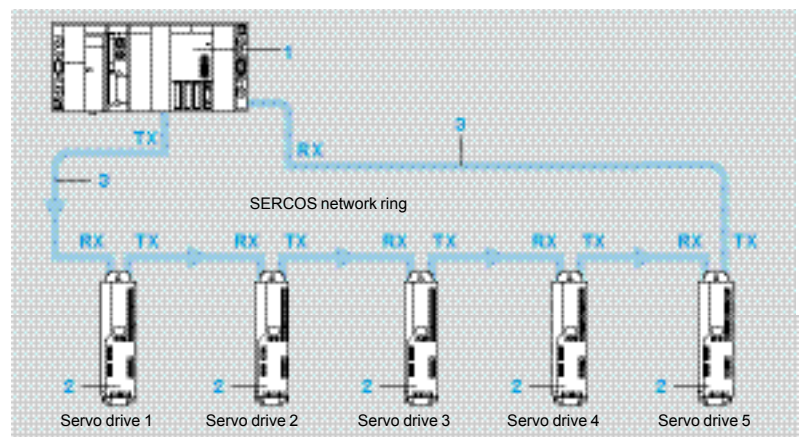

- 1 **TSX CSY 84/85/164**: multi-axis motion control module for Premium PLC.
  - 2 **LXM 15●●M3/N4/N4X**: Lexium 15 servo drives fitted with the SERCOS AM SER 001V000 option card.
  - 3 **990 MCO 000 ●●**: plastic fiber-optic cables fitted with SMA-type connectors.
- TX** Transmission  
**RX** Reception

(1) To order other accessories please consult our "Automation platform Modicon Premium and Unity - PL7 software" specialist catalog

# Modicon® Premium™ automation platform

## TSX™ ISP Plus Integrated weighing system

The *ISP Plus* weighing system, when used with the Modicon® Premium™ PLC, enables the integration of weighing equipment into automated machine processes

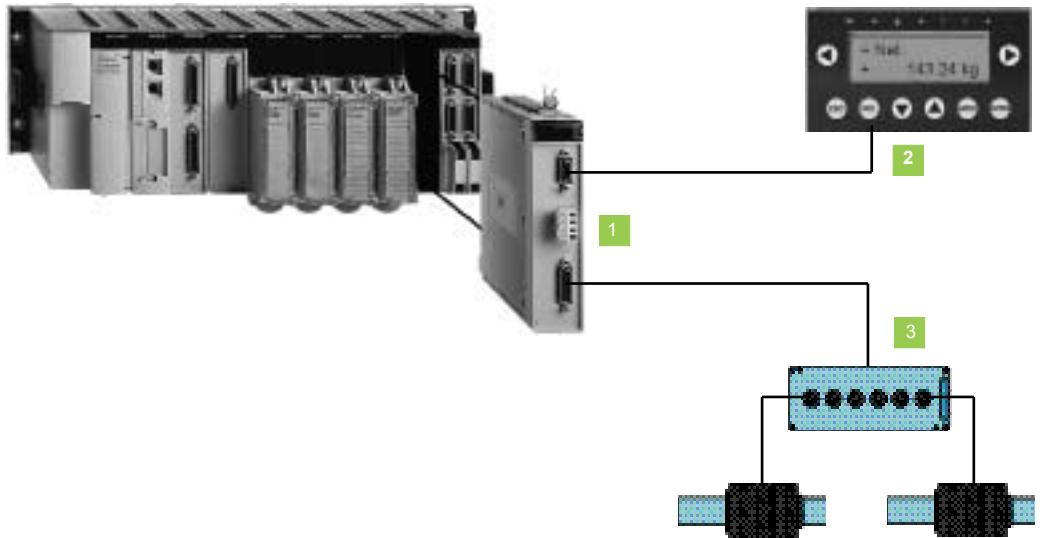

4

### 1 Weighing module

The **TSX™ ISP Y101** standard format weighing module is the central part of the weighing system. It has:

- A measurement input that will accept up to 8 sensors.
- A sealable link for the display unit.
- Two discrete reflex outputs for weigher doser applications.

### 2 Weight indicator

The **TSX™ XBT N410** remote display unit displays the measured weight with no prior configuration. When the link to the weighing module is sealed, this display unit then becomes the main display unit for commercial transactions.

The **TSX ISP Y121** module/display unit assembly conforms to OIML recommendations and is CÉ approved for class III weighers (6000 scale divisions) and for class IIIII weighers (1000 scales divisions).

### 3 Accesories

Junction boxes, cables and test circuit.

# Modicon® Premium™ automation platform

## TSX™ ISP Plus Integrated weighing system

When a **TSX™ ISP Y101** weighing module is plugged into a Modicon® Premium™ programmable controller, it is possible to go beyond the scope of a simple weighing application. The PLC manages not only the entire weighing environment, but also the whole of the machine or industrial process associated with the weighing system.

In a Premium configuration, the number of **TSX ISP Y101** weighing modules must be added to the other dedicated modules (TSX™ SCY 21601 communication, TSX™ CTY counting, TSX™ CAY/CSY axis control and TSX™ CFY movement control). The maximum of **TSX ISP Y101** weighing module (2 application-specific channels per module) permissible is :

- 2 dedicated modules with TSX™ P57 0● processor.
- 4 dedicated modules with TSX P57 1● processor.
- 12 dedicated modules with TSX P57 2● processor.
- 16 dedicated modules with TSX P57 3● processor.
- 32 dedicated modules with TSX P57 4●/5●/6● processor.

### Description

#### Weighing module

The **TSX ISP Y101** weighing module has the following on the front face:

- 1 A SUB-D 9-way female connector for the dedicated RS 485 serial link to the weight indicator.
- 2 A screw terminal block for connecting the 2 discrete reflex outputs (outputs used with threshold detection).
- 3 A SUB-D 15-way female connector for the indicator input channel (50 samples per second, from 1 to 8 load cells).
- 4 Module sealing device, if required.



#### Weighing indicator

Weight values are displayed on a **TSX™ XBT N410** weight indicator (supplied with the TSX ISP Y121 unit). The weight indicator is pre-configured.

It has the following on the front face:

- 1 An LCD, back-lit display screen with 4 lines of 20 characters (height 4,34 mm).
- 2 Two control or contextual link keys, non configurable
- 3 Six service keys

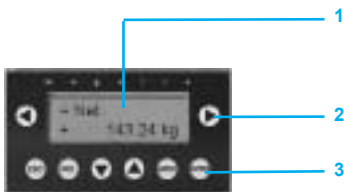

The back is equipped with:

- A plug-in screw terminal block for  $\overline{\text{---}}$  24 V external power supply.
- A 25-way SUB-D type female connector for connection to the **TSX ISP Y101** weighing module (30 m maximum).

#### Strain gauge type load cells and connection accessories

Consult your Schneider Electric Regional Sales Office.

### Functions

The weighing module with its associated display unit constitutes a weighing indicator. The module incorporates numerous functions specific to weighing:

- Continuous weighing (in g, kg, t, lb, oz...) and flow calculation (weight variation).
- Filtering of measurements by several methods (19 filtering options).
- Tare (automatic/manual) and preset tare.
- Automatic reset.
- Weighing stability control.
- Threshold detection with extrapolation of the cut-off point: positioning of local "discrete" outputs to the nearest millisecond.
- Assisted calibration: the module calculates the zero point and the gradient.
- Calibration parameters saved in the module (EEPROM) and in the Modicon® Premium™ processor.
- Forced calibration: fast replacement of an inoperative module and restarting using the previous calibration parameters.
- Locking of the configuration, sealing of the module and its connections to the load cells and weight indicator.
- Continuous formatting and transmission of measurements to the PLC.
- Transmission of measurement validity data (validity, stability, nett/gross...).
- Transmission of diagnostic data from the module and its connections.
- Configuration, calibration and debugging via Unity™ Pro or PL7™ Junior/Pro screens.
- Most of the operating parameters can be modified and most of the functions can be run by PLC program.

### Setting up the weighing module

Unity™ Pro or PL7™ Junior/Pro software allows complete setting up of the weighing system (configuration, calibration and debugging).

#### Configuration

This covers:

- The measuring data of the weigher.
- Filtering of measurements.
- The flow calculation method.
- The tare.
- Data format.
- Stability criteria and zero point management method.
- Threshold monitoring for positioning of discrete outputs.

#### Weigher calibration

The module itself calculates the gain and the offset to be applied to the electronic weighing system. Calibration is carried out in two phases:

- Measurement of the dead load.
- Measurement of a standard weight.

Forced calibration allows immediate restarting of the system in the event that a module becomes inoperative; the new module is configured automatically.

#### Debugging

The dedicated weighing screen provides the following dynamic display:

- The measurement in progress.
- The operating state of the module.

It also allows fast modification of setting parameters (filtering, flow, threshold values...).

Instructions and parameters that can be modified by the program in real time with the module.

These parameters and instructions can be monitored from an operator dialog type device and/or a supervisory device connected to the Premium.

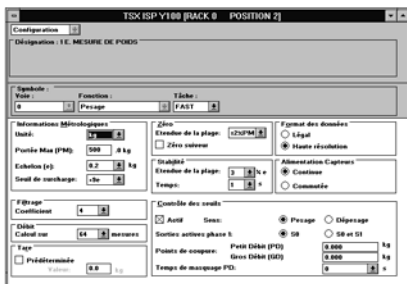

Configuration

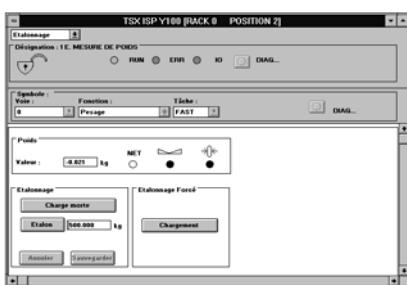

Weigher calibration

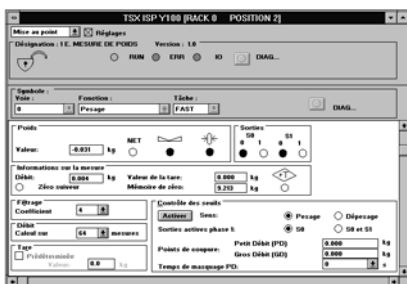

Debugging

**Electrical characteristics of weighing module TSX™ ISP Y101**

<b>Measurement input</b>	1 weigher per module		1 measurement input
	Resolution		1 048 576 points (20 bits)
	Measuring rate		50 measurementss per second
	Input impedance	M $\Omega$	> 1
<b>Input load cells</b>	Number that may be connected		Maximum of 8 x 350 $\Omega$ load cells, connected in parallel
	Supply voltage	V	--- 10
	Supply type		d.c.
	Cabling distance	m	300 (without loss of accuracy with 4 load cells)
<b>Discrete reflex outputs</b>	Number		2 positive logic transistor outputs, for sack weighing, filling and sort/check weighing.
	Nominal voltage	V	--- 24
	Nominal current	mA	500
	Response time		1 ms discrimination. The point at which the thresholds are crossed between 2 measurements is calculated by polling to the nearest millisecond.
<b>Weight indicator output</b>	Physical interface		RS 485 non isolated
	Binary flow	K bit/s	9.6
	Remote connection distance	m	30 (maximum)
<b>Consumption</b>		mA	See page 9/6
<b>Environment</b>	Weights and measures		The weighing module associated with its weight indicator conforms to OIML recommendations. It is C $\epsilon$ approved for class III (up to 6000 divisions) and class IIII (up to 1000 divisions) weighers in accordance with European circular 90 384 of 20th June 1990.
	Minimum voltage division	$\Omega$ V	1
	C $\epsilon$ certification		SDM n° 97.06 - Revision of 15 june 1999 LCIE 03 ATX 6399X of 21 january 2004

**Characteristics of weight indicator Magelis® TSX™ XBT N410**

<b>Display</b>	Type of screen		Green back-lit LCD	
	Number of lines		1 line of 5 characters (17.36 x 11.8 mm) to 4 lines of 20 characters (4.34 x 2,95 mm) For weighing applications, used 2 lines of 10 characters (8.38 x 5.9 mm)	
<b>Keys</b>			8 keys	
<b>Alimentation</b>	Nominal voltage	V	--- 24 non isolated	
	Limit voltages	V	--- 18...30	
	Ripple		5 % max.	
	Consumption	W	5 max.	
<b>Signalling</b>			–	
<b>Environment</b>	Conforming to standards		IEC/EN 61131-2, IEC/EN 60068-2, UL 508, CSA 22.2 No. 14	
	Product certifications		C $\epsilon$ , UL, CSA Class 1, Div. 2 (UL and CSA), ATEX zone 2/22	
	Temperatures	Operation	° C	0...55
		Storage	° C	- 20...+ 60
	Degree of protection	Front pannel		IP 65, conforming to IEC/EN 60529, Nema 4X (outdoor use).
Rear panel			IP 20, conforming to IEC/EN 60529	

# Modicon® Premium™ automation platform

## TSX™ ISP Plus

### Integrated weighing system



TSX ISP Y111



TSX ISP Y121



SM1 PS371



SM1 PY52



SF2 PY3504



TSX XBT N410

#### TSX™ ISP Plus weighing modules

Description	Composition	Reference	Weight kg
<b>ISP Plus weighing modules</b> (1 weigher per module) (1) Supplied non calibrated	Standard format module (sealable) - Load cell input 50 meas./s (for 1 to 8 load cells), - 2 reflex discrete outputs (for threshold detection), - RS 485 output (for display)	<b>TSX™ ISP Y101</b>	0.420
	- Module TSX ISP Y101. - Indicator TSX XBT N410 (LCD back-lit, preconfigured display). - Module/weight indicator connecting cable (length 3 m)	<b>TSX ISP Y121</b>	1.020

#### Accessories for maintenance test (supplied with a 4 m cable)

Function	For use with	Mounting	Reference	Weight kg
<b>Load cell simulation</b>	ISP Plus	Separated	<b>SM1 PS371</b>	0.520
<b>Test circuit</b> (voltage)	ISP Plus	Separated	<b>SM1 PS381</b>	0.100

#### Junction boxes for load cells

Material	Number of load cells	Reference	Weight kg
<b>Metal</b> (2)	4	<b>SF2 PY3504</b>	0.800

#### Intrinsically safe junction box (3)

This box is installed in the weighing system between the weighing indicator and the junction box in which the load cells are grouped. Its function is to limit any peak voltages and to limit the current to 100 mA in the event of a short circuit. The load cells and junction box are the only devices located in the hazardous environment; the weighing indicator is located outside the hazardous environment.

Description	For use with	Marking	Reference	Weight kg
<b>Zener barrier box</b>	Load cells and weighing indicators	EEx ib II B EEx ib II C	<b>SM1 PY52</b>	2.800

#### Remote weight indicator

Description	Length	Reference	Weight kg
<b>Weight indicator for connection to the ISP Plus weighing module</b> --- 24 V external supply	–	<b>TSX™ XBT N410</b>	0.380
<b>Module/weight indicator connecting cables</b>	5 m	<b>SF3 CPY005</b>	0.500
	10 m	<b>SF3 CPY010</b>	1.100
	15 m	<b>SF3 CPY015</b>	1.700
	20 m	<b>SF3 CPY020</b>	2.200
	25 m	<b>SF3 CPY025</b>	2.800
	30 m	<b>SF3 CPY030</b>	3.400

(1) The setup of weighing modules requires Unity™ Pro ≥ V2.0 or PL7™ Junior/Pro ≥ V4.1. software.

(2) When a weighing system is located in an explosive environment, a metal junction box must be used.

(3) Equipment approved by the Laboratoire Central des Industries Electriques (LCIE) (Central Laboratory for the Electric Industries).



References (continued)



SF3 PY32●●●

Description	For connection to	Length m	Reference	Weight kg
Indicator cable: 6-core with 1 SUB-D type 15-way connector for ISP Plus	Junction box SF2 PY3504	3 m	SF3 PY32003	0,300
		10 m	SF3 PY32010	1,100
		20 m	SF3 PY32020	2,200
		30 m	SF3 PY32030	3,400
		40 m	SF3 PY32040	4,500
		50 m	SF3 PY32050	5,600
		60 m	SF3 PY32060	6,900
		80 m	SF3 PY32080	9,000
		120 m	SF3 PY32120	13,500
		200 m	SF3 PY32200	22,500
300 m	SF3 PY32300	33,500		

Dimensions, mouting

Junction boxes SF2 PY3504

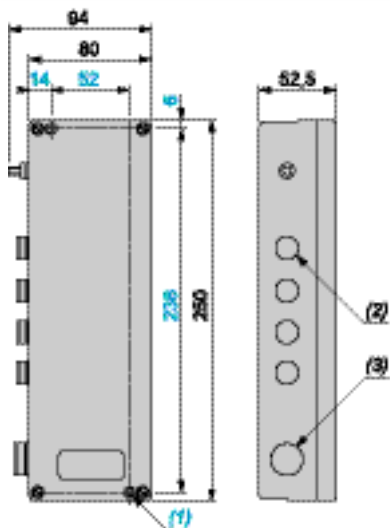

- (1) 2 fixing holes for Ø 4 mm screws and lead sealing.
- (2) 4 cable glands, capacity 5 mm max..
- (3) 1 cable gland, capacity 8 mm max..

Zener barrier box SM1 PY52

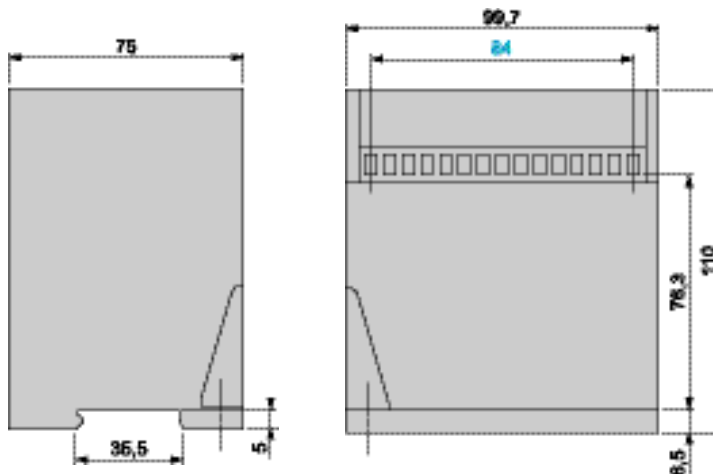

Mouting zener barrier box SM1 PY52

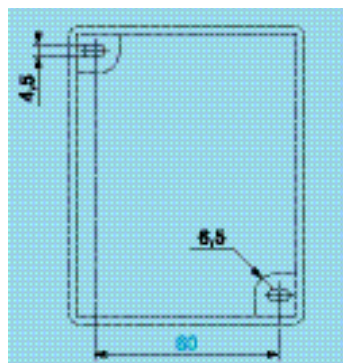

Weight indicator TSX™ XBT N410

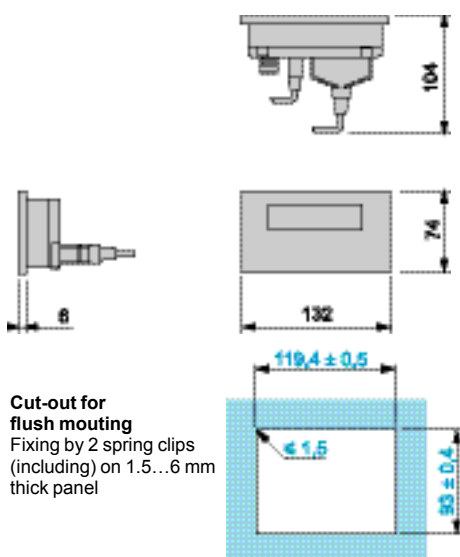

**Cut-out for flush mouting**  
Fixing by 2 spring clips (including) on 1.5...6 mm thick panel

# Modicon® Premium™ automation platform

## Hot Standby system

### Unity™ Pro software

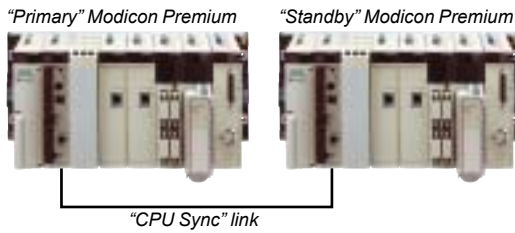

#### Presentation

The Modicon® Premium™ Hot Standby redundancy system is compatible with Unity™ Pro software. It helps to ensure continuity of operation for an automation system based on the Modicon Premium platform in the event that one of the following becomes inoperative:

- The central processing and communication functions
- The I/O system

It is based on the “Primary/Standby” redundancy principle, with complete redundancy of the main processing and communication functions, the use of shared I/O on the Ethernet Modbus®/TCP network, a Modbus® link and/or redundancy of in-rack I/O (single-rack configuration only).

Premium Hot Standby redundant architectures offer an ideal solution for availability requirements when changeover time is not critical. They are designed for processes which can tolerate a lack of control on the part of the Premium™ PLC lasting up to one second (average changeover time from the “Primary” unit to the “Standby” unit and for updating shared I/O on Ethernet).

They can meet availability requirements when the purpose of the PLC is to monitor and control an installation in continuous operation, signal incidents to a control station, and transmit command instructions from the supervision manager to various locations on an extensive site.

Example areas of application:

- Centralized technical management of a public facility (tunnel, airport, signals, etc.)
- Control/monitoring of a water treatment or distribution station
- Electrical technical management
- Hydroelectric power production

#### Principle

At the center of the system, there are two Modicon Premium single-rack configurations called the “Primary” PLC and the “Standby” PLC. Their hardware and software configurations are identical (i.e. identical modules in each rack). The offer is comprised of two processor models (**TSX H57 24M** and **TSX H57 44M**) designed specifically for Hot Standby architectures with Unity Pro software (version ≥ 3.1). This dual processor configuration combines the functions of the CPU and redundant coprocessor in the same unit.

The “Primary” PLC:

- Executes the application program and manages the I/O, which can take the form of:
  - Field devices on an Ethernet network managed by the I/O Scanning service (see page 5/30)
  - Field devices on a Modbus® master link
  - Sensors and actuators connected to Premium I/O modules on bus X with single-rack configuration
- Manages the transfer of data via the “CPU Sync” link to the “Standby” PLC at the start of every cycle

In the event the “Primary” PLC becomes inoperative, the standby system changes over automatically, whereby execution of the application program and control of the I/O is changed over to the “Standby” PLC within 1.5 cycles, with an up-to-date data context.

An automatic mechanism for the assignment of “IP” and “IP + 1” addresses changes the addresses of the Ethernet network modules with the 2 Premium configurations which manage the field devices. The same mechanism is used for “n” and “n + 1” slave address assignments for Modbus link modules.

Once they have changed over, the “Standby” PLC becomes the “Primary” PLC. Once the inoperative PLC has been repaired and reconnected to the standby system, it takes the role of the “Standby” PLC.

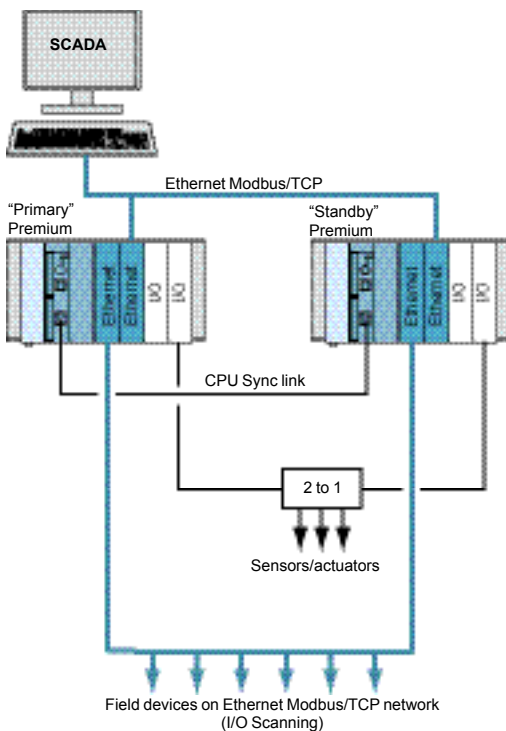

# Modicon® Premium™ automation platform

## Hot Standby system

### Unity™ Pro software

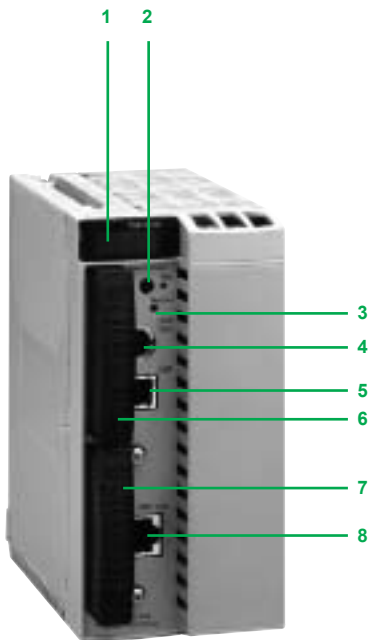

TSX H57 24M/44M

#### Hot Standby processors TSX™ H57 24M/44M

The double-format Modicon® Premium™ Hot Standby processors TSX™ H57 24M and TSX™ H57 44M display the following features on the front panel:

1 Display unit consisting of six LEDs:

- RUN LED (green):
  - LED permanently on: Processor in “Primary” mode during operation (program running)
  - Flashing 2.5 s (on)/0.5 s (off): Processor in “Standby” mode during operation (execution of first program section)
  - Flashing 0.5 s (on)/2.5 s (off): Processor not in standby mode
  - Flashing 0.5 s (on)/0.5 s (off): PLC in Stop mode
- ERR LED (red):
  - LED permanently on: Detected fault on the processor or its on-board devices (PCMCIA memory card)
  - Flashing 0.5 s (on)/0.5 s (off): Detected application fault
- TER LED (yellow): Activity on the TER/AUX terminal port
- I/O (red), permanently on: Detected fault on another module on the PLC station, or detected configuration fault
- STS LED (yellow):
  - Flashing 0.5 s (on)/0.5 s (off): Redundant mode between the “Primary” and “Standby” processors is OK
  - LED permanently on: Standby mode not active or being initialized
  - Off: Processor does not pass self test
- ACT LED (yellow): Activity on the “CPU Sync” link between the “Primary” and “Standby” processors is OK

Diagnostics at redundancy mode level is supported by the 3 LEDs (RUN, ERR and STS) on the TSX™ ETY 4103/5103 communication modules managing the shared I/O on Ethernet.

- 2 Memory Extract button: Not operational on Hot Standby processors
- 3 RESET button which initiates a cold restart of the PLC when activated
- 4 8-way female mini-DIN connector marked TER/AUX for connecting a programming, adjustment or user interface terminal
- 5 USB connector marked TER for connecting a programming terminal (requires UNY XCA USB 033 3.3 m connection cable for connection to a compatible PC; to be ordered separately)
- 6 PCMCIA slot (no. 0) for a memory extension card
- 7 PCMCIA slot (no. 1) for a memory extension card to store additional data (1)
- 8 RJ45 connector marked HSBY Link, designed for Hot Standby communication between the “Primary” and “Standby” processors

#### “CPU Sync” link

The “CPU Sync” link 8 (marked HSBY Link) on the front panel of Hot Standby processors is an Ethernet 10BASE-T/100BASE-TX port dedicated to data exchange between the “Primary” and “Standby” PLCs on the standby system.

This link is used by the active “Primary” PLC (from the point of view of the system I/O) to replicate its context (status of its data) with the “Standby” PLC on every application cycle in such a way that, in the event of a changeover triggered by the “Primary” PLC becoming inoperative, the “Standby” PLC can take control of the automation system within 1.5 processor cycles.

The “CPU Sync” link is a copper link with a maximum length of 100 m.

⚠ The use of active components (transceivers, switches, ...) on “CPU Sync” link is strictly forbidden.

#### USB port

The USB port 5 with a useful data rate of 12 Mbit/s is compatible with Unity™ Pro programming software and OPC Factory Server (OFS)™ software.

TSX™ H57 24M/44M processors can be connected to a USB bus with several peripheral devices. However:

- Only one processor can be connected to the USB bus.
- None of the equipment on the USB bus (such as the modem or printer) can be controlled by the PLC.

(1) PCMCIA communication cards, reference TSX™ SCP 11● (Modbus®, Uni-Telway™, serial link), TSX™ CPP 110 (CANopen), TSX™ FPP 20 (Fipway®) and TSX™ MBP 100 (Modbus Plus™), are not authorized for use in slot 1 on Hot Standby processors.

#### Elements for redundancy

- 1 6, 8 or 12-position non-extendable rack **TSX™ RKY ●**
- 2 Power supply module **TSX™ PSY ●●●M**
- 3 Premium Hot Standby processor **TSX H57 24M/44M**
- 4 Ethernet network module **TSX ETY 4103/5103**  
(version ≥ sv 4.0)

#### Ethernet ring shared elements

- 15 Modicon M340 automation platform featuring processor with built-in Ethernet port **BMXP34 2020/2030**
- 16 Advantys STB modular distributed I/O with network interface module **STB NIP 2212**
- 17 Altivar 61/71 variable speed drive with communication card **VW3 A3 310**
- 18 Advantys OTB Optimum distributed I/O with interface module **OTB 1E0 DM9LP**
- 19 Magelis XBT GT graphic terminal with on-board Ethernet port **XBT GT ●●30/40**

#### Other possible shared elements:

- Advantys FTM, IP 67 modular I/O
- Momentum distributed I/O
- **TSX ETG 100/1000** gateway for connecting Modbus devices
- W@de remote management modules (RTU), designed for water applications **TSX HEW 315/320/330**
- Inductel/Ositrack identification system **XGK S1715503** and **XGK Z33ETH**
- Lexium servo drives with communication card **AMO ETH 001V000**
- Preventa **XPS MF** compact and modular safety PLCs

#### Ethernet wiring elements:

- 10 ConneXium™ managed switch with 2, 4 or 8 10/100BASE-TX ports **TCS ESM 0●3**
- 11 CPU Sync link, copper crossover cable **490 NTC 000 ●●●**
- 12 Copper straight-through cable **490 NTW 000 ●●●**
- 13 Copper crossover cable **490 NTC 000 ●●● (1)**

(1) For Ethernet ring lengths > 100 m, the copper link is replaced by a multimode optical fiber link (max. 3 km) or a single-mode optical fiber link (max. 20 km) by using ConneXium switches **TCS ESM 043F2CS0** with a copper straight-through cable **490 NTW 000 ●●●** (optical fiber is not included in Schneider Electric's scope of supply).

**Note:** In cases where other "Primary" and "Standby" PLC Ethernet modules are required to be "monitored", in order to extend the redundancy field (for the Ethernet SCADA network, for example), an application program must be written in each PLC.

### Architectures

#### Typical architecture

In this type of architecture, the I/O system in Modicon® Premium™ PLCs equipped with a dedicated Hot Standby TSX™ H57 24M/44M processor is defined by the distribution of field devices or equipment on the Ethernet Modbus®/TCP network. From an operational point of view, the following devices or equipment are connected on the same Ethernet network:

- Client: Twido® controller, Modicon® Premium™ PLC, Magelis® HMI, W@de remote management module, etc.
- Modbus/TCP server: Advantys™ OTB/Momentum™ distributed I/O, Advantys STB I/O islands, Altivar® variable speed drives, Lexium® servo drives, Inductel/Ositrack identification systems, etc.

The Ethernet I/O Scanning service enables client-server exchanges between a PLC and Ethernet equipment communicating by means of the Modbus/TCP protocol. This service can be used to define up to 64 periodic read or write exchanges in the form of a configuration, based on tables of (word type) variables for target devices or equipment. The I/O Scanning service is a function that is available as standard with TSX™ ETY 4103/5103 Ethernet network modules.

The Ethernet network topology for connecting Ethernet Modbus/TCP modules on PLCs to distributed devices/equipment can be a bus or ring type topology with a copper or fiber-optic cable.

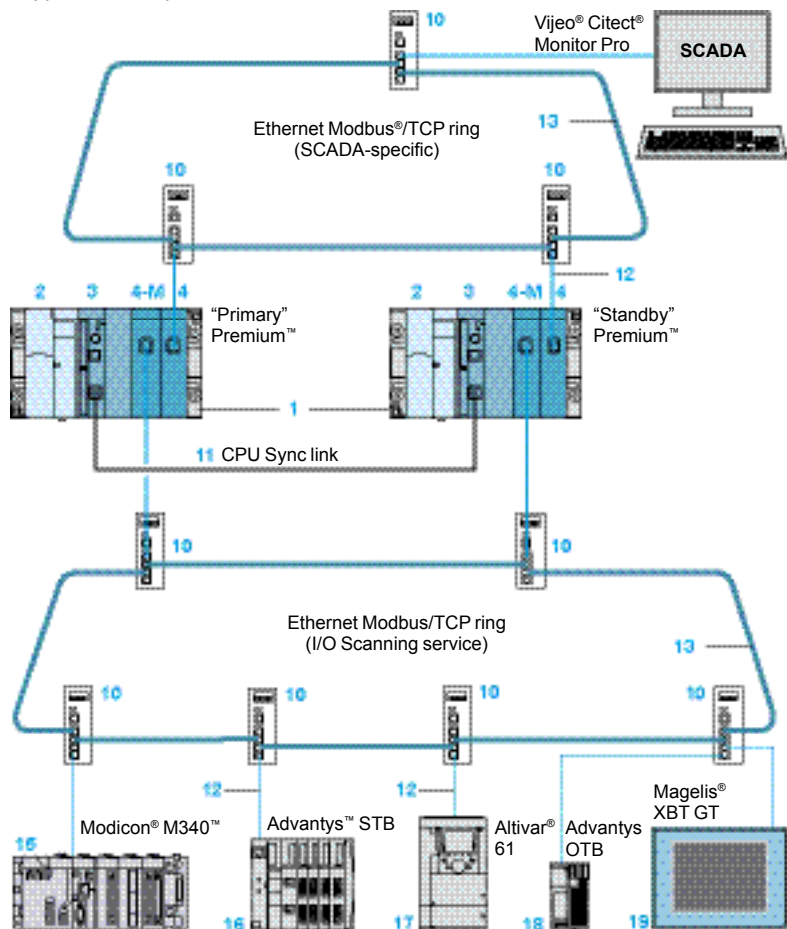

#### "Monitored" Ethernet network modules

When configuring the Hot Standby system using Unity™ Pro software, an Ethernet module (4-M) located on both the "Primary" and the "Standby" PLCs, must be defined as having the status "monitored" and use the Ethernet I/O Scanning service. This status assigns the module with the task of monitoring that it is functioning correctly, as well as monitoring its electrical link to its Ethernet switch. A detected failure (affecting the "monitored" module or its Ethernet link) will trigger a Hot Standby changeover from the "Primary" PLC to the "Standby" PLC.

#### Architectures (continued)

#### Architecture with redundant I/O on Bus X

In this type of architecture, the discrete and analog I/O on bus X are the redundant elements. The discrete and analog I/O modules that control them are positioned within each “Primary” and “Standby” single-rack configuration.

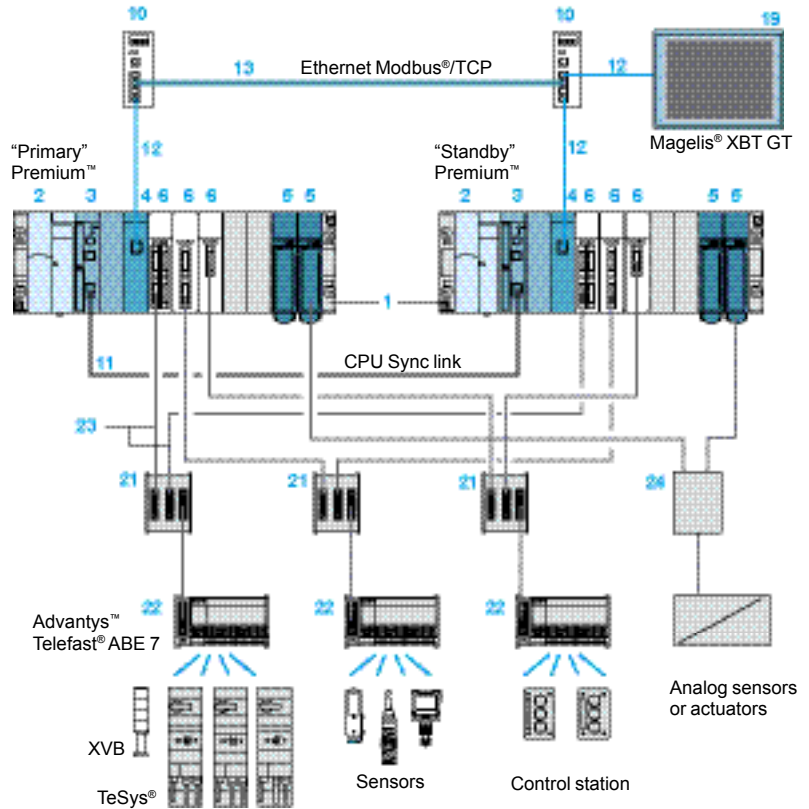

#### Elements for redundancy:

- 1 6, 8 or 12-position non-extendable rack **TSX™ RKY ●**
- 2 Power supply module **TSX™ PSY ●●●M**
- 3 Hot Standby processor **TSX™ H57 24M/44M**
- 4 Ethernet network module **TSX™ ETY 4103/5103**  
(version ≥ sv 4.0)
- 5 Analog I/O modules **TSX™ AEY/ASY ●●●**
- 6 16, 28, 32 or 64-channel discrete I/O modules  
(1 HE 10 connector per 16 channels)  
**TSX™ DEY/DSY/DMY 16/28/32/64●●K**

#### Advantys Telefast ABE 7 and JM Concept wiring elements:

- 21 Redundancy sub-bases:
  - 16 in 2 x 16 input channels **ABE 7ACC 11**
  - 16 in 2 x 16 output channels **ABE 7ACC 10**
- 22 16-channel passive sub-bases **ABE 7H16●●●** or adaptor sub-bases for 16-channel inputs or outputs  
**ABE 7S16/7R16/7P16●●●**
- 23 Cables equipped with 2 HE 10 connectors **TSX CDP ●●3**  
(length: 0.5, 1, 2, 3, 5 or 10 m)
- 24 Multiplexer for analog inputs **JK 3000 N2** or outputs  
**GK 3000 D1** (supplied by JM Concept)

#### Ethernet wiring elements:

- 10 ConneXium™ switch with 4, 8 or 16 10/100BASE-TX ports  
**499 NES ●●1 00** (unmanaged) or **TCS ESM ●●3** (managed)
- 11 CPU Sync link, copper crossover cable **490 NTC 000 ●●●**
- 12 Copper straight-through cable **490 NTW 000 ●●●**
- 13 Copper crossover cable **490 NTC 000 ●●● (1)**

#### Human Machine Interface:

- 19 Magelis XBT GT graphic terminal with on-board Ethernet port **XBT GT ●●30/40**

(1) See Note (1) on page 4/62 of this catalog.

#### Management of redundant I/O

Each “Primary” and “Standby” Premium™ PLC has a group of identical I/O modules on its TSX™ RKY ● rack.

The discrete sensors/actuators are connected to 16-channel Advantys™ Telefast® passive or adaptor sub-bases ABE 7H16/S16/R16.

The analog sensors/actuators are connected via a JM Concept converter. Visit [www.jmconcept.com](http://www.jmconcept.com)

For redundant inputs, the sensor information is transmitted simultaneously to the “Primary” and “Standby” PLCs via the 2 identical input modules placed in the Premium racks. Two Advantys Telefast ABE 7 16-channel sub-bases, ABE 7ACC11 with redundant inputs and ABE 7ACC10 with redundant outputs, can be used to achieve this double wiring easily using cables equipped with HE 10 connectors. The output values are generated solely by the application processing of the “Primary” PLC, which sends its commands to the corresponding output modules. During each cycle, the “Standby” PLC receives the “Primary” PLC’s output values via the CPU Sync link and applies them to its own outputs. This update enables “Normal/Standby” changeover to take place smoothly during the changeover time.

**Note:** Output fallback values: Within a Hot Standby system, the redundant output modules must be configured with fallback to 0, while the outputs of the shared elements (on Ethernet I/O Scanning or Modbus) must be configured to maintain their state.

**Note:** When using TSX PAY 262/282 Preventa safety modules: Within a Hot Standby system, the modules are authorized in the Premium racks subject to compliance with the wiring recommendations. Please consult your Regional Sales Office.

**Architectures (continued)**

**SCADA architecture on Modbus® and shared I/O on Ethernet Modbus/TCP**

As in the typical architecture shown on page 4/62 of this catalog, the I/O in the Modicon® Premium™ Hot Standby system is shared on an Ethernet network (with a bus topology as shown in the example below). However, the SCADA interface is connected to the standby system via a Modbus serial link.

The Ethernet Modbus/TCP network modules are configured to be “monitored” so that they can trigger a Hot Standby changeover in the event of a detected failure (of the Ethernet module or electrical link and its switch). See page 4/62, 4 - M

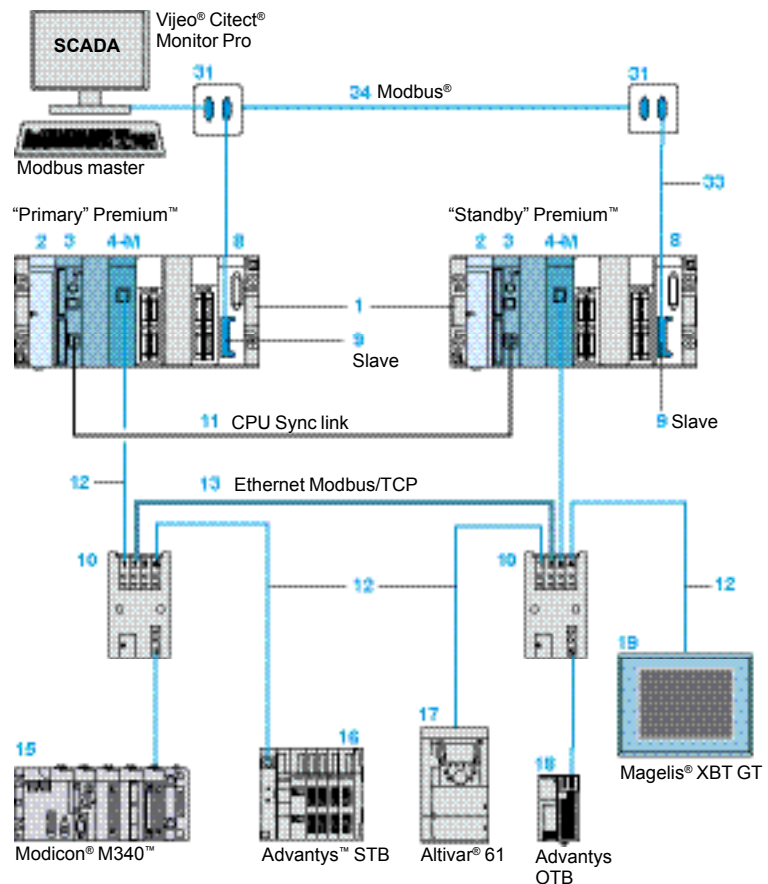

**Elements for redundancy:**

- 1 6, 8 or 12-position non-extendable rack **TSX™ RKY ●**
- 2 Power supply module **TSX™ PSY ●●●M**
- 3 Hot Standby processor **TSX™ H57 24M/44M**
- 4 Ethernet network module **TSX™ ETY 4103/5103** (version ≥ sv 4.0)
- 8 Communication module **TSX™ SCY 21601** whose integrated channel cannot be used in this type of architecture
- 9 PCMCIA RS 485 isolated card **TSX™ SCP 114** used with the Modbus slave protocol

**Shared elements on the Ethernet network:**

- 15 Modicon® M340™ automation platform featuring processor with built-in Ethernet port **BMXP34 2020/2030**
- 16 Advantys™ STB modular distributed I/O with network interface module **STB NIP 2212**
- 17 Altivar® 61/71 variable speed drive with communication card **VW3 A3 310**
- 18 Advantys OTB Optimum distributed I/O with interface module **OTB 1E0 DM9LP**
- 19 Magelis® XBT GT graphic terminal with on-board Ethernet port **XBT GT ●●30/40**

**Other possible shared elements:** See page 4/62 of this catalog.

**Ethernet wiring elements:**

- 10 ConneXium™ unmanaged switch with 5 10BASE-T/100BASE-TX ports **499 NES 251 00**
- 11 CPU Sync link, copper crossover cable **490 NTC 000 ●●●**
- 12 Copper straight-through cable **490 NTW 000 ●●●**
- 13 Copper crossover cable **490 NTC 000 ●●●**

**Modbus wiring elements:**

- 31 Passive junction box, connection via screw terminals with line termination **TSX™ SCA 50**
- 33 Tap cable for PCMCIA card with flying leads at one end **TSX™ SCP CM 4030** (length 3 m)
- 34 RS 485 double shielded twisted pair trunk cable **TSX™ CSA 100/200/500** (length 100, 200 or 500 m)

**SCADA supervision system**

In this type of architecture, the redundancy of the SCADA station, which is based on Vijeo® Citect® or Monitor Pro supervision software, is provided by a Modbus® serial link on which the SCADA station is the master. Via their TSX SCY 21601 communication module, equipped with a TSX SCP 114 PCMCIA RS 485 card, the “Primary” and “Standby” PLCs have the slave addresses “n” and “n + 1” respectively.

A detected failure triggers a changeover from the “Standby” to the “Primary” PLC and brings about an automatic change in the Modbus addresses: The address of the new “Primary” PLC becomes “n” and the address of the old one becomes “n+1”.

# Modicon® Premium™ automation platform

## Hot Standby system

### Unity™ Pro software

#### Architectures (continued)

Shared devices on Modbus®, and shared I/O on Ethernet Modbus/TCP

In this type of architecture, the devices, peripheral devices or equipment in the Modicon® Premium™ Hot Standby redundant system are:

- Shared on an Ethernet network (with a bus topology as shown in the example below)
- Shared on a Modbus® link, and can thus support a large number of diverse peripheral devices or items of equipment (Schneider Electric or third-party) equipped with a Modbus slave interface

As with the previous types of architecture, this type can support a SCADA supervision system on Ethernet or Modbus.

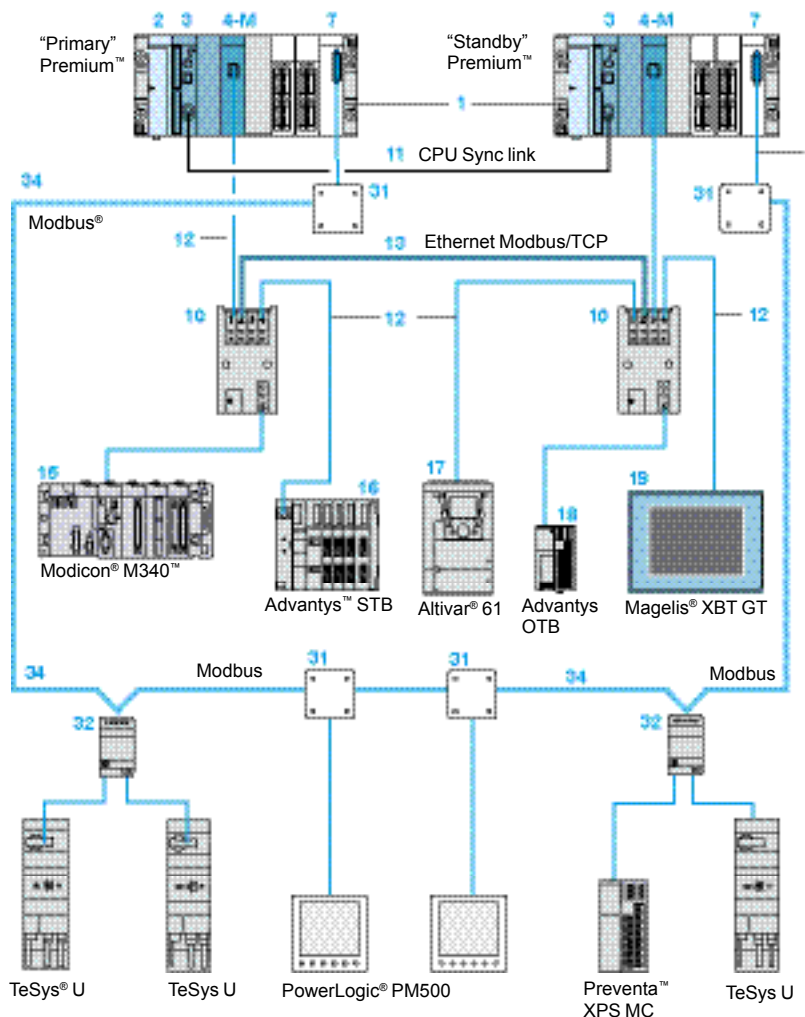

#### Elements for redundancy

- 1 6, 8 or 12-position non-extendable rack **TSX™ RKY ●**
- 2 Power supply module **TSX™ PSY ●●●M**
- 3 Hot Standby processor **TSX™ H57 24M/44M**
- 4 Ethernet network module **TSX™ ETY 4103/5103** (version ≥ sv 4.0)
- 7 Communication module **TSX™ SCY 11601/21601** whose integrated channel is used in the Modbus master

#### Shared elements on Modbus®: Examples

- TeSys® U starter-controllers
- PowerLogic® PM500 LV/MV power meters
- Preventa™ XPS MC safety controllers

#### Shared elements on the Ethernet network

- 15 Modicon® M340™ automation platform featuring processor with integrated Ethernet port **BMX P34 2020/2030**
- 16 Advantys™ STB modular distributed I/O with network interface module **STB NIP2212**
- 17 Altivar® 61/71 variable speed drive with communication card **VW3 A3 310**
- 18 Advantys™ OTB Optimum™ distributed I/O with interface module **OTB 1E0 DM9LP**
- 19 Magelis® XBT GT graphic terminal with on-board Ethernet port **XBT GT ●●30/40**

#### Ethernet wiring elements

- 10 ConneXium™ unmanaged switch with 5 10BASE-T/100BASE-TX ports **499 NES 251 00**
- 11 CPU Sync link, copper crossover cable **490 NTC 000 ●●●**
- 12 Copper straight-through cable **490 NTW 000 ●●●**
- 13 Copper crossover cable **490 NTC 000 ●●●**

#### Modbus wiring elements

- 31 Passive junction box **TSX™ SCA 50**, connection via screw terminals with line termination
- 32 Junction box with line isolation **TWD™ XCA ISO**, connection of trunk cable via screw terminal and of 2 tap-offs via RJ45 connector
- 34 RS 485 double shielded twisted pair trunk cable **TSX SCA 100/200/500** (length 100, 200 or 500 m)
- 35 Tap cable for integrated channel **TSX SCY CM 6030** (length 3 m), 25-pin SUB-D connector with flying leads at one end

#### Redundant I/O on Modbus

In this type of architecture, the peripheral devices or equipment are shared by the Modbus link on which the two PLCs ("Primary" and "Standby") are masters. The other peripheral devices or equipment connected to the Modbus link are slaves. Each Premium PLC has a **TSX SCY 11601** or **TSX SCY 21601** communication module **7** with an integrated isolated RS 485 link (25-pin SUB-D connector).

The **TSX SCA 50** splitter box **31** positioned at the level of each Premium PLC ("Primary" and "Standby") includes the line termination. In addition, the **TSX SCY 11601/21601** communication modules polarize the Modbus line. Disconnecting a slave during operation will not impair Modbus communication in any way.

### Functions

#### Functions of “Primary” and “Standby” PLCs

“Primary” and “Standby” PLCs are physically and functionally identical; the difference in their roles lies in their status (“Primary” or “Standby”).

#### “Primary” Premium™ PLC

- Executes the entire application program
- Updates the inputs and outputs according to the in-rack architecture selected on Bus X, Modbus® and/or Ethernet network
- Facilitates communication with peripheral devices
- Sends its data to the “Standby” PLC via the dedicated “CPU Sync” link and retrieves diagnostic information from the “Standby” PLC.
- Generates its own diagnostic information as well as that of the Hot Standby architecture

#### “Standby” Premium™ PLC

- Reads the state of the in-rack inputs on bus X of the “Standby” PLC
- Reads the image of the “Primary” PLC inputs (in-rack inputs on bus X, Modbus and/or Ethernet)
- Executes the application in part (only the first section of the program)
- Updates the image of its outputs according to the execution of the first section of the program
- Facilitates communication with peripheral devices
- Retrieves diagnostic information from the “Primary” PLC
- Generates its own diagnostic information as well as that of the Hot Standby architecture

#### Management of “Primary/Standby” states

One of the following elements becoming inoperative:

- Main rack power supply
- PLC processor

The TSX™ ETY 4103/5103 “monitored” Ethernet Modbus/TCP network module automatically triggers a “Primary/Standby” changeover. For all other elements, “Primary/Standby” changeover can be customized via the application program (manual changeover).

#### Management of shared I/O on Ethernet network

The “Primary” PLC can easily be configured to manage the exchange of shared I/O states on the Ethernet network (bus or ring type). Thanks to the advanced I/O Scanning service, there is no need for specific programming.

Only the “Primary” PLC reads the physical inputs on the network and controls the/ physical outputs on it.

During each cycle, the “Standby” PLC receives the images of the I/O on the Ethernet network from the “Primary” PLC via the dedicated “CPU Sync” link. This updating of the memory facilitates smooth “Primary/Standby” changeover during the changeover time (devices or equipment maintaining their state on fallback).

#### Management of redundant I/O

For redundant inputs, sensor information is transmitted simultaneously to the “Primary” and “Standby” PLCs via the input module placed in the racks of each PLC. The output values are generated solely by the application processing of the “Primary” PLC, which sends its commands to the corresponding output modules. During each cycle, the “Standby” PLC receives the “Primary” PLC output values via the dedicated “CPU Sync” link and applies them to its own outputs. This update method facilitates smooth “Primary/Standby” changeover during the changeover time (outputs with fallback to 0).

#### Management of supervision transparency (SCADA)

Another pair of TSX™ ETY 4103/5103 Ethernet Modbus/TCP modules helps to ensure transparent communication with level 2 (supervisor, third-party device, etc) during changeover of the PLC in “Primary” mode to the PLC in “Standby” mode. Communication with a redundant architecture is, therefore, similar to that with a standard architecture. This transparency is the result of the automatic mechanism for the assignment of “IP” and “IP + 1” addresses.

It can also be achieved on Modbus by using the TSX SCP 114 PCMCIA card (Modbus slave protocol in RS 485) installed in the TSX SCY 21601 communication module (automatic mechanism for the assignment of “n” and “n + 1” slave addresses).

#### Services provided by TSX ETY 4103/5103 Ethernet Modbus/TCP modules within the Hot Standby architecture

Standard Web: “Rack Viewer” and “Data Editor”
FactoryCast™ configurable Web (TSX ETY 5103 only)
User Web pages (8 MB with TSX ETY 5103)
Modbus®/TCP messaging
HTTP, FTP, XIP, Telnet
I/O Scanning
NTP time synchronization (with TSX ETY 5103)
SMTP e-mail notification (via Unity™ Pro function blocks)
Network manager, SNMP agent



#### Functions (continued)

##### Memory space

The memory space reserved for the application program and the data is managed by the Hot Standby system with Unity™ Pro software. With an on-board RAM memory of 192 or 440 Kb (depending on the model), the RAM memory on **TSX™ H57 24M** and **TSX™ H57 44M** processors dedicated to Hot Standby applications can be increased for the application program to 768 or 2048 Kb (depending on the model) by adding a PCMCIA memory card.

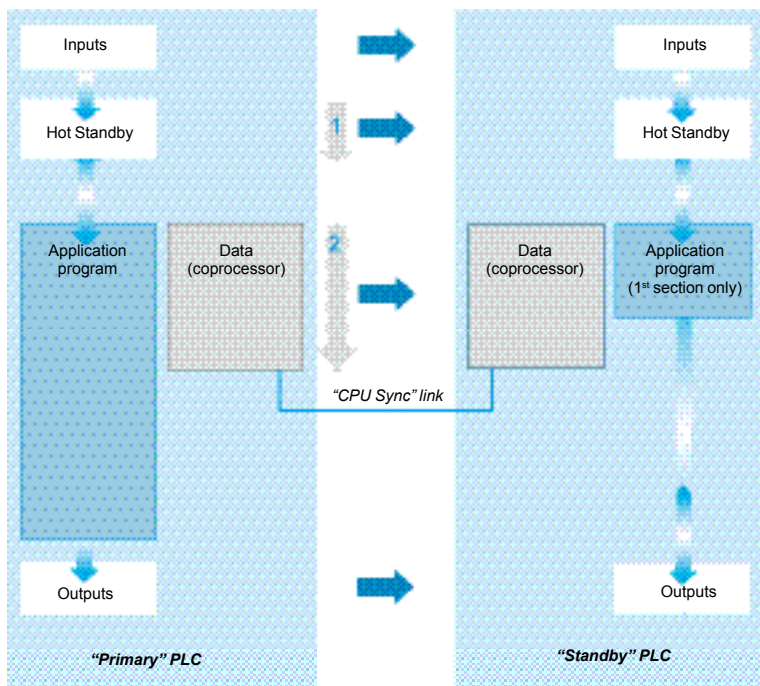

##### Configuration

Installation of the application program does not differ fundamentally from installing a simple PLC program. It essentially uses the information requested by dedicated dialog boxes, which must be entered at configuration stage in the Unity Pro software.

##### Cyclic transfer of the application context

At the start of each scan cycle, the content of the data memory in the "Primary" PLC is transferred to the "Standby" PLC via the dedicated "CPU Sync" link, at the same time as the content of the tables containing the images of the input/output states are transferred to it. The Hot Standby system is thus able to transfer a data zone (I/O image, located (1) and unlocated internal data) from the "Primary" PLC to the "Standby" PLC comprising:

- 192 Kb max. with the **TSX H57 24M** processor
- 440 Kb max. with the **TSX H57 44M** processor

The exchange principle is illustrated in the diagram opposite, along with the exchange times according to data volume, where:

Hot Standby system: 10 ms for 100 Kb  
Data transfer via the coprocessor: 30 ms for 100 Kb. This data transfer takes place in parallel with the execution of the "Primary" PLC application program.

(1) The first 100 %MW words in each located data zone are not exchanged. Therefore, they can be assigned to data for a specific process on the "Primary" or "Standby" PLC.

4

#### Dimensions

ABE 7ACC10/11 redundancy sub-bases

TSX™ SCA50 passive splitter box

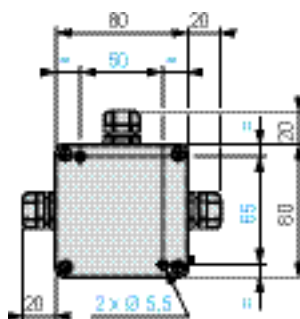
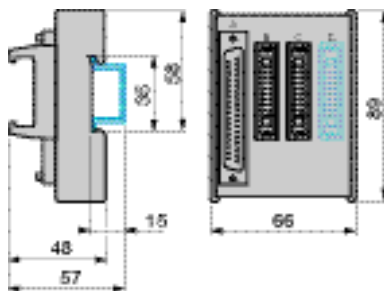

Note: For other dimensions, refer to the dimensions pages in this catalog.

4

Characteristics and performance					
Type of processor			TSX™ H57 24M	TSX™ H57 44M	
<b>Maximum configuration</b>	No. of racks	6/8/12 slots	1		
	Maximum no. of module slots		12		
<b>Functions</b>	Maximum no. (1)	Discrete I/O	1024, limited to 512 (max. 8 slots)	2048, limited to 512 (max. 8 slots)	
		Analog I/O	80	256, limited to 128 (max. 8 slots)	
	Control channels		10 (up to 30 parameterizable simple loops)	20 (up to 60 parameterizable simple loops)	
		Programmable loops via EFB control blocks (with Unity Pro Large and Extra Large)			
	Application-specific channels		24, limited to 16 (max. 8 slots)	64, limited to 16 (max. 8 slots)	
		TSX SCY 11/21 601 serial link modules only	TSX SCY 11/21 601 serial link modules only		
	Integrated connections	Ethernet	1 CPU Sync link dedicated to exchanges between "Primary" and "Standby" processors 10BASE-T/100BASE-TX (RJ45 connector), max. length 100 m		
		Serial link	⚠ The use of active components (transceivers, switches, ...) on CPU Sync link is strictly forbidden.		
			1 x RS 485 serial link, 19.2 kbit/s, marked TER/AUX (8-pin mini-DIN connector) 1 USB link, 12 Mbit/s, marked TER (USB type A connector)		
	Max. no. of connections	Ethernet	2 (TSX ETY 4103/5103 modules, version ≥ sv 4.0)	4 (TSX ETY 4103/5103 modules, version ≥ sv 4.0)	
Other		Any of AS-Interface®, CANopen®, Fipway®, Modbus Plus™, Profibus DP™, INTERBUS®, etc. type			
<b>Memories</b>	Maximum capacity	Without PCMCIA card	<b>Kb</b> 192, program + data	440, program + data	
		With PCMCIA card	<b>Kb</b> 768, program 192, data	2048, program 440, data	
		Data storage	<b>Kb</b> 16,384 (limited to 8192 with current PCMCIA cards)		
	Maximum size of object areas	Located internal bits	<b>Bits</b> 8056 %Mi	32,634 %Mi	
		Located internal data	<b>Words</b> 32,464 for internal %Moi 32,760 for constant %Moi		
		Unlocated internal data	Elementary EDT and derived DDT data: Unlimited (2) DFB and EFB function data: Unlimited size per instance, unlimited no. of instances (2)		
	Max. size of data exchanged via CPU Sync link	<b>Kb</b> 192 max.	440 max.		
<b>Application structure</b>	Tasks	Master	1		
		Fast	Use is prohibited in a Hot Standby architecture		
		Auxiliary	-		
		Event-triggered	Use not recommended as tasks are not synchronous with exchange cycles from the "Primary" PLC to the "Standby" PLC		
<b>Execution time for one instruction</b> (limited values)	Without PCMCIA card	Boolean	<b>µs</b> 0.039 to 0.057, depending on type of instruction		
		On word or fixed point arithmetic	<b>µs</b> 0.054 to 0.073, depending on type of instruction		
		On floating points	<b>µs</b> 0.550 to 0.630, depending on type of instruction		
	With PCMCIA card	Boolean	<b>µs</b> 0.048 to 0.057, depending on type of instruction		
		On word or fixed point arithmetic	<b>µs</b> 0.054 to 0.073, depending on type of instruction		
		On floating points	<b>µs</b> 0.550 to 0.630, depending on type of instruction		
<b>Typical program code execution time for 1 Kinstruction</b>	Without PCMCIA card	100% Boolean	<b>Kinst /ms</b> 15.75		
		65% Boolean and 35% fixed arithmetic	<b>Kinst /ms</b> 11.40		
	With PCMCIA card	100% Boolean	<b>Kinst /ms</b> 15.75		
		65% Boolean and 35% fixed arithmetic	<b>Kinst /ms</b> 11.40		
<b>Times specific to the standby system</b>	Transfer between processor and coprocessor TSX H57 ●4M "Primary" to "Standby" changeover		10 per 100 Kb of data exchanged via CPU Sync link		
			1.5 cycle times to resume in-rack I/O exchanges on bus X 1 s to resume exchanges on Ethernet I/O Scanning		
	Transfer of data from "Primary" to "Standby"	<b>ms</b>	30 per 100 Kb of data exchanged via CPU Sync As this data transfer is managed by the coprocessor, the transfer time TTD progresses in parallel with the application cycle time TC, which means that the application cycle time TC is not affected unless TTD > TC.		
<b>System overhead</b>	Task	Master	<b>ms</b> 1.00		

(1) The I/O on the Modbus link or on the Ethernet Modbus®/TCP network should not be taken into account for these values.

(2) Within the limits of the processor's data memory capacity

# Modicon® Premium™ automation platform

## Hot Standby system

### Unity™ Pro software



TSX H57 24M/44M



TSX ETY 4103/5103



TSX SCY 21 601

TSX SCY 11 601



TSX SCP 114



490 NTC 000



ABE 7ACC10/11

### References

#### Hot Standby processors with Unity™ Pro

Type Rep..	I/O capacity	Memory capacity		No. of Ethernet network modules	Integrated ports	Reference	Weight kg
		Memory	Control channel				
<b>TSX™ 57 2</b> 3	1024 discrete I/O 80 analog I/O channels 0 application-specific channels (1)	192 Kb integrated 768 Kb max. on PCMCIA card	10	2	- 1 x RS 485 - 1 x 12 Mbit/s USB - 1 x 100 Mbit/s Ethernet port dedicated to "CPU Sync" link	<b>TSX™ H57 24M</b>	0.560
<b>TSX™ 57 4</b> 3	2048 discrete I/O 256 analog I/O channels 0 application-specific channels (1)	440 Kb integrated 2048 Kb max. on PCMCIA card	20	4	- 1 x RS 485 - 1 x 12 Mbit/s USB - 1 x 100 Mbit/s Ethernet port dedicated to "CPU Sync" link	<b>TSX H57 44M</b>	0.560

#### Modules to be installed in "Primary" and "Standby" rack (depending on architecture)

Designation Rep..	Description	Transparent Ready services	Reference	Weight kg
<b>Ethernet Modbus®/TCP modules</b> version ≥ sv 4.0 4	Speed: 10/100 Mbit/s, 10BASE-T/100BASE-TX	Class B30 Standard Web server, I/O Scanning, SMTP, SNMP  Class C30 Configurable Web server, I/O Scanning, NTP, SMTP, SNMP	<b>TSX™ ETY 4103</b>  <b>TSX ETY 5103</b>	0.340  0.340
<b>Serial link communication modules</b> 7-8	<b>7-8</b> One integrated isolated RS 485 channel, Modbus® protocol, character mode and Uni-Telway™ One serial link PCMCIA card slot  <b>7</b> One integrated isolated RS 485 channel, Modbus protocol		<b>TSX™ SCY 21601</b>  <b>TSX SCY 11601</b>	0.360  0.340
<b>PCMCIA card</b> 9	RS 485, 1.2 to 19.2 Kbit/s, Modbus protocol, character mode and Uni-Telway For TSX SCY 21601 communication module		<b>TSX™ SCP 114</b>	0.105
<b>I/O modules</b>	<b>6</b> Discrete  <b>5</b> Analog  Preventa safety, type TSX PAY		See pages 3/10 to 3/12  See pages 3/26 and 3/27  See pages 4/63 and 4/8	

#### Separate connection parts (3)

Designation Rep..	Use/composition (4)	Length	Reference (4)	Weight kg
<b>Crossover cables for "CPU Sync" link 11</b> <b>Inter-switch link 13</b>	Shielded twisted pairs to standard EIA/TIA 658 Equipped with 1 RJ45 connector at each end	5 m	<b>490 NTC 000 05</b>	–
		15 m	<b>490 NTC 000 15</b>	–
		40 m	<b>490 NTC 000 40</b>	–
		80 m	<b>490 NTC 000 80</b>	–
<b>Straight-through cables for Ethernet TSX ETY ●103 module link and switch</b> 12	Shielded twisted pairs to standard EIA/TIA 658 Equipped with 1 RJ45 connector at each end	2 m	<b>490 NTW 000 02</b>	–
		5 m	<b>490 NTW 000 05</b>	–
		12 m	<b>490 NTW 000 12</b>	–
		40 m	<b>490 NTW 000 40</b>	–
		80 m	<b>490 NTW 000 80</b>	–
<b>Advantys™ Telefast® ABE 7 redundancy sub-bases</b> 21 (connection on 3 HE 10 connectors)	For redundant discrete in-rack I/O (5) 16 channels in 2 x 16-channels	Input channels –	<b>ABE 7ACC11</b>	0.075
		Output channels –	<b>ABE 7ACC10</b>	0.075

Rep.: Refer to the architectures shown on pages 4/62 to 4/65 of this catalog.

(1) The Premium Hot Standby system does not support application-specific channels (counter, motion control and weighing). Only application-specific communication channels (serial links) are authorized.

(2) Require specific setup instructions in the Hot Standby configuration. Please consult your Regional Sales Office.

(3) Other separate parts: ConneXium managed and unmanaged switches: See pages 5/54 to 5/60; Advantys Telefast ABE 7: See pages 8/8 to 8/17.

(4) For crossover and straight-through cables with shielded twisted pairs that are UL and CSA22.1 approved, add U at the end of the reference. For example: **490 NTC/NTW 000 05U**.

(5) For in-rack analog I/O, multiplexers 24 supplied by JM Concept, please visit [www.jmconcept.com](http://www.jmconcept.com).



# Modicon® Premium™ automation platform

## Warm Standby system PL7™ Pro software

### Presentation

Compatible only with the **PL7™ Pro** software, the Modicon® Premium™ Warm Standby redundancy system helps to ensure continuity of operation for a control system based on a Premium platform in the event one of the following becomes inoperative:

- Central processing and communication functions.
- The I/O system.

It is based on the “Normal/Backup” redundancy principle with complete redundancy of the main processing and communication functions, the use of simple I/O shared on a Fipio® bus and/or redundancy of in-rack I/O.

It covers the availability requirements when the purpose of the PLC is to monitor an installation in continuous operation, signal incidents to a control station, and transmit command instructions from the supervision manager to various locations on an extensive site. It is aimed at processes which can tolerate a lack of control on the part of the PLC lasting 1 to 2 s (average time for changeover from the “Normal” to the “Backup” unit).

Areas of application:

- In the commercial sector:
  - centralized technical management of a public facility (tunnel, airport, etc),
  - control/monitoring of a water treatment or distribution station,
  - electrical technical management.
- In the industrial sector:
  - food and beverage processing,
  - slow chemical processes,
  - level/temperature monitoring, etc.

# Modicon® Premium™ automation platform

## Warm Standby system

### PL7™ Pro software

#### Principle

The Premium Warm Standby architecture combines physical redundancy of the PLC with “Normal/Backup” type operation.

Only the “Normal” PLC processes the application and generates the outputs. The “Backup” PLC applies the outputs generated by the “Normal” PLC, performs self-diagnostics and permanently diagnoses the “Normal” PLC.

In event of a malfunction on the “Normal” PLC, the “Backup” PLC takes control and then becomes the “Normal” PLC (the inoperative PLC, previously “Normal”, becomes the “Backup”).

Optimum availability of the application is provided by:

- Automatic or manual “Normal/Backup” changeover.
- Smooth changeover on the actuators.
- Updating of the “Backup” PLC on each cycle.
- Signalling of the inoperative component.
- Online repair.
- Transparent supervision (SCADA).

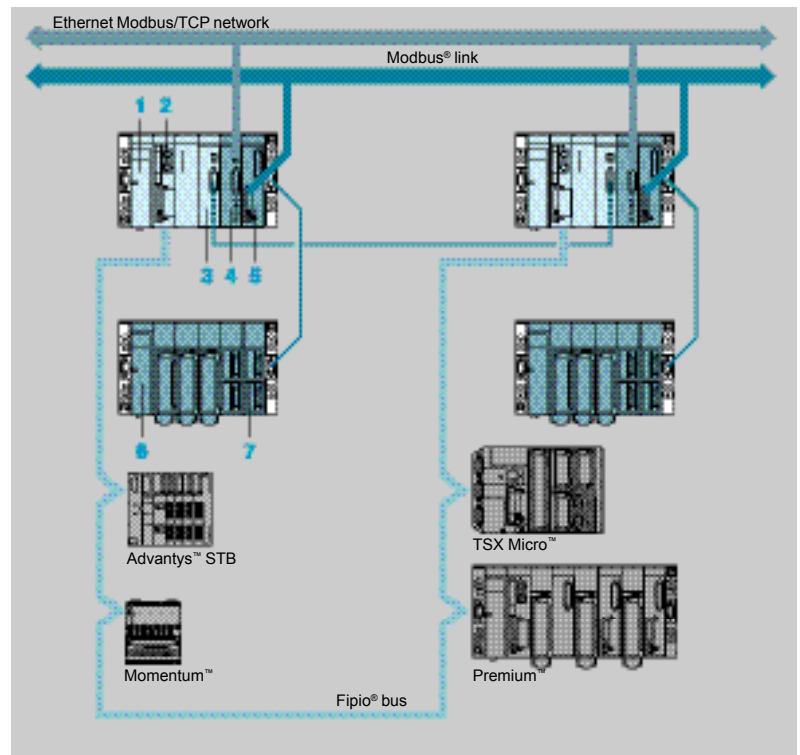

- Essential elements for redundancy
  - 1 TSX™ PSY●●●0M power supply
  - 2 TSX™ P57 353AM/453AM processor
  - 3 TSX ETY 110WS Ethernet communication module
- Optional elements for redundancy
  - 4 TSX™ ETY 210 Ethernet communication module
  - 5 TSX™ SCY 21601 communication module with TSX™ SCP 114 Modbus protocol PCMCIA card
  - 6 TSX™ PSY●●●0M power supply
  - 7 TSX™ D●Y discrete I/O modules
- Shared elements on the Fipio bus

Elements which can be redundant are:

- The main rack.
- The main rack power supply.
- The processor.

Possibly accompanied by:

- Discrete input modules.
- Discrete output modules.
- One or more extendable racks with their power supply.
- One or more Ethernet network or Modbus® bus communication modules.

Elements of the Fipio® bus shared between the “Normal” and “Backup” PLCs are:

- Discrete or analog input modules (Advantys™ STB or Momentum™) (1).
- Discrete or analog output modules (Advantys STB or Momentum) (1).
- One or more TSX Micro™/Premium™ agent PLCs (these can support the entire range of I/O: discrete, analog or application-specific).

(1) TBX distributed I/O legacy modules are also possible as shared elements .

**Functions**

**“Normal” and “Backup” PLC functions**

The “Normal” and “Backup” Modicon® Premium™ PLCs are physically and functionally identical, but their role is differentiated according to their status: “Normal” or “Backup”. The “Normal” Premium™ PLC:

- Executes the application.
- Updates the outputs and inputs (in-rack and on the Fipio® bus).
- Provides communication functions with peripheral devices.
- Sends its database to the “Backup” PLC.
- Recovers diagnostic information from the “Backup” PLC.
- Generates its own diagnostic information as well as that of the Premium Warm Standby architecture.

The “Backup” Premium™ PLC:

- Executes part of the application.
- Reads the state of the in-rack inputs.
- Updates its in-rack and Fipio outputs according to the state of those of the “Normal” PLC.
- Provides communication functions with peripheral devices.
- Recovers diagnostic information from the “Normal” PLC.
- Generates its own diagnostic information as well as that of the Premium Warm Standby architecture.

**Management of shared I/O on Fipio bus**

The Fipio® bus manages I/O exchanges on Fipio devices. The “Normal” PLC is an arbitrator for the active Fipio bus while the “Backup” PLC is an arbitrator for the passive Fipio network.

Due to the characteristics of the Fipio bus, only the “Normal” PLC reads the physical inputs on the Fipio bus and controls the physical outputs on the Fipio bus. The “Backup” PLC does not access the Fipio bus.

During each cycle, the “Backup” PLC receives the values of the I/O on the Fipio bus from the “Normal” PLC via the inter-PLC Ethway link (TSX ETY 110WS module) and applies them to its own outputs. This updating of the memory enables smooth “Normal/Backup” changeover by maintaining the state of the I/O during changeover.

**Management of “Normal/Backup” states**

Malfunction of one of the following elements automatically causes a “Normal/Backup” changeover:

- Main rack power supply.
- PLC processor.
- **TSX™ ETY 210** communication module.
- Fipio bus connected to the integrated processor port.

For other elements, “Normal/Backup” changeover can be customized (manual changeover).

**Management of optional redundant I/O**

For redundant inputs, the sensor information is transmitted simultaneously to the “Normal” and “Backup” PLCs via the 2 input modules placed in each PLC. Two Advantys™ Telefast® 16-channel sub-bases, **ABE 7ACC10** with redundant inputs and

**ABE 7ACC11** with redundant outputs, can be used to perform this double wiring easily using preformed HE 10 connector connection cables, (see page 4/75 of this catalog, refs. [14](#), [15](#), [20](#) and [21](#)).

The output values are only generated by the application processing of the “Normal” PLC. This sends its commands to the corresponding output modules.

During each cycle, the “Backup” PLC receives the “Normal” PLC output values via the inter-PLC Ethway™ link (TSX ETY 110WS module) and applies them to its own outputs. This updating enables smooth “Normal/Backup” changeover by maintaining the state of the outputs during changeover.

**Management of supervision transparency (SCADA)**

Transparent communication with level 2 (supervisor, third-party device, etc) during changeover of the PLC in “Normal” mode to the PLC in “Backup” mode is provided by the **TSX™ ETY 210** Ethernet modules, using a unique IP address.

Communication with a redundant architecture is therefore similar to that for a simple architecture. This transparency is identical in Modbus® with the use of the **TSX™ SCP 114** PCMCIA card (Modbus protocol in RS 485) installed in the **TSX™ SCY 21601** communication module.

## Functions

### Ring topology for shared equipment on the Fipio® bus

To improve the availability of shared equipment on the Fipio bus, it is possible to create a Fipio redundant ring using fiber-optics. The fiber-optic ring can then be used to:

- Maintain normal operation in the event of a break at some point on the fiber-optic medium.
- Increase the immunity of the Fipio bus in environments with high levels of electromagnetic interference.

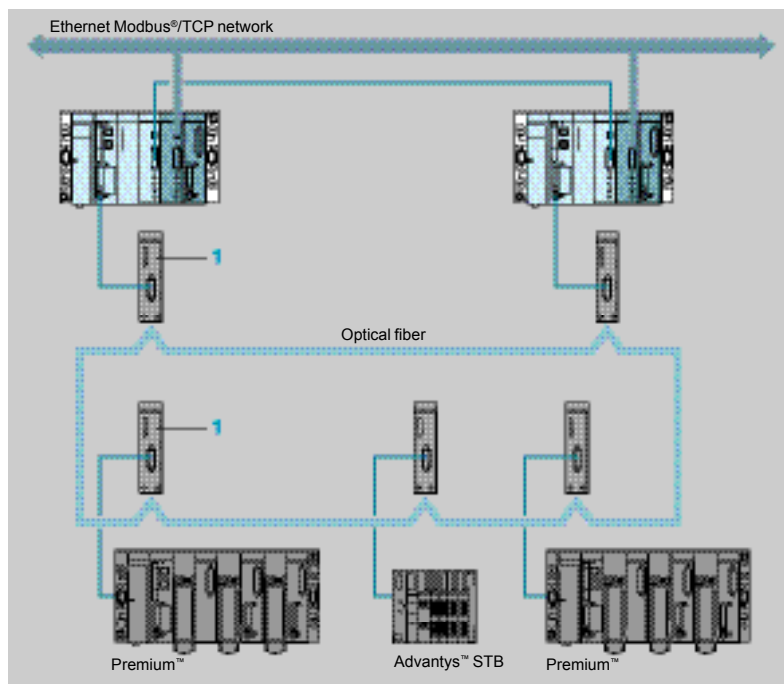

1 OZD FIP G3 fiber-optic transmitter (see page 5/85).

## Software setup

Modicon® Premium™ Warm Standby redundant architecture is set up using **PL7™ Pro** software (1), in exactly the same way as a standard non-redundant process is set up. It is, however, necessary to apply the rule that the application program of both the “Normal” and “Backup” PLCs must be completely identical.

Redundancy entails certain special features which, if taken into account at the start of the development task, are very simple to set up using the additional Premium Warm Standby application design software **TLX CD WSBY P40E**.

This software can perform the following functions:

- Taking account of Normal/Backup states during program execution.
- Sharing the database between the 2 PLCs via DFB user function blocks and EF elementary function blocks.
- Management of redundant in-rack I/O.
- Management of shared I/O on the Fipio bus.

(1) Warm Standby non compatible with Unity™ Pro software.

References



TSX ETY 210

Description	Type	Reference	Weight kg
<b>Software package</b> for setting up a Warm Standby redundant architecture on Premium	Equipment with 1 station (equipped with PL7 Pro software)	<b>TLX CD WSBY P40E</b>	–
<b>Ethernet Modbus®/TCP communication module</b> for Premium™ Warm Standby redundant architecture	Identical to those of the TSX ETY 110WS module (see page 5/45). For the Warm Standby architecture, this module also provides: - transparent addressing during changeover - diagnostics of the architecture (self-tests, state of the Ethernet link and of the TSX ETY 210 dual module), - la maintenance with access to the “backup” PLC	<b>TSX™ ETY 210</b>	0.270

**Additional compatible elements**

The Warm Standby architecture presented on page 4/71 of this catalog shows the essential elements for redundancy. Compatible standard modules can be added to this minimum configuration according to the requirements of the process being automated.

**Elements for redundancy (sold in lots of 2) (1)**

- Bus X remote system:
  - TSX™ REY 200 Bus X remote module, for increasing the length of Bus X to 2 x 350 m.
- Communication:
  - TSX™ ETY 210 Ethernet communication module, for communication with level 3,
  - TSX™ SCP 114 Modbus communication PCMCIA card, for Modbus® Slave communication with transparent addressing for third-party devices. This card should be inserted in the slot in the **TSX SCY 21601** communication module.
- Discrete and analog I/O:
  - TSX™ DEY ●●K discrete input modules with HE 10 connectors with ABE 7ACC11 Advantys™ Telefast® redundant sub-bases,
  - TSX™ DSY ●●K discrete output modules with HE 10 connectors with ABE 7ACC10 Advantys Telefast redundant sub-bases,
  - TSX™ DMY ●●K discrete mixed I/O modules with HE 10 connectors with ABE 7ACC11/10 Advantys Telefast redundant sub-bases.

**Shared elements on the Fipio bus**

- Advantys™ STB distributed I/O modules:
  - STB NFP 2212 Fipio interface module,
  - STB DDI/DAI/DDO/DAO/DR● discrete I/O modules,
  - STB AVI/ACI/ART/AVO/ACO analog I/O modules,
- TSX EEF/ESF/EMF dust and damp proof discrete I/O base units.
- Momentum™ I/O modules:
  - 170 FTN 110 01 Fipio communication module,
  - 170 ADI/ADO/ADM discrete I/O base units,
  - 170 AAI/AAO/AMM analog I/O base units.
- Fipio® agent PLCs:
  - Modicon® Premium™ PLC, can accommodate I/O and application-specific modules,
  - TSX Micro™ PLC, can accommodate I/O and application-specific modules .
- Other shared elements:
  - OZF FIP G3 fiber-optic transmitter, can be used to create a Fipio bus fiber-optic ring,
  - TSX FP ACC 6 Fipio electrical repeater, increases the length of the bus by the creation of segments, each 1000 m maximum.

(1) The TSX AEU/ASY I/O analog modules, the TSX CTY/CCY/CAY/CSY/CFY/ISP Y application-specific modules are no redundancy elements. They can be used as shared elements with Fipio agent Premium PLCs

4



ABE 7ACC10/11



# Modicon® Premium™ automation platform

Warm Standby system  
PL7™ Pro software

Example of architecture with redundant I/O and shared I/O on Fipio® bus

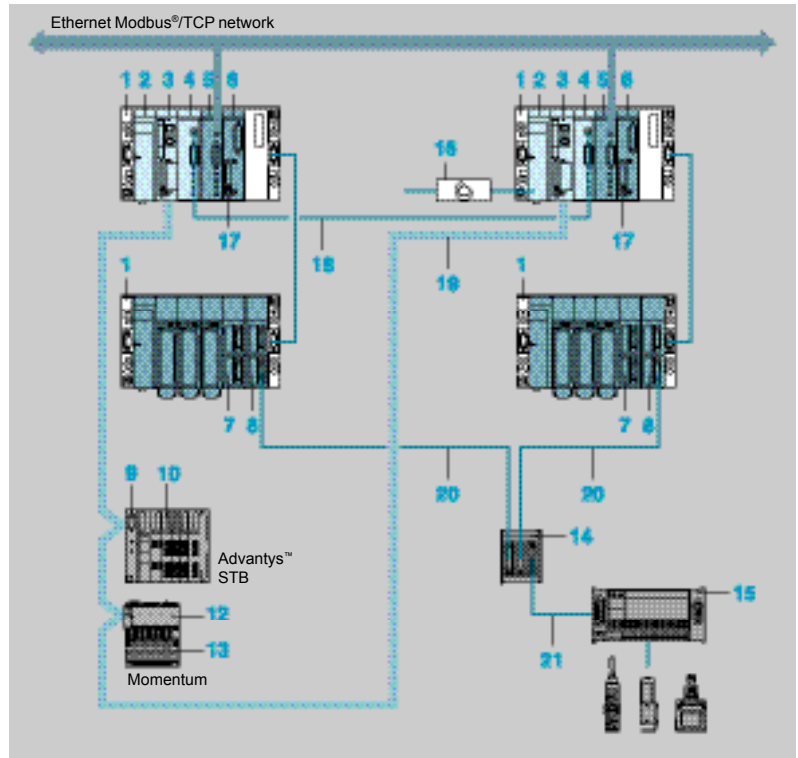

- 1 TSX™ RKY ●EX: Modicon® Premium™ extendable rack.
- 2 TSX™ PSY●●●0M: power supply module.
- 3 TSX™ P57 353AM/453AM: Premium processor with integrated Fipio® link.
- 4 TSX™ ETY 110WS: Ethernet Modbus®/TCP network module.
- 5 TSX ETY 210: Ethway/Ethernet Modbus/TCP network module.
- 6 TSX™ SCY 21601: communication module for type III PCMCIA card.
- 7 TSX™ DSY●●K: discrete output modules, for redundancy.
- 8 TSX™ DEY●●K: discrete input modules, for redundancy.
- 9 STB NFP 2212: Fipio interface module for Advantys™ STB distributed I/O with TSX™ FP ACC2/12 connector (polycarbonate/zamak)
- 10 STB D●/D●O/DR●/A●/A●O: Advantys STB distributed discrete input/output modules.
- 12 170 FNT 110 00: Fipio communication module for Momentum™ base unit with TSX FP ACC2/12 connector (polycarbonate/zamak).
- 13 170 ADI/AAI/ADM●●●: discrete or analog I/O Momentum base unit.
- 14 ABE 7ACC11/10: Advantys™ Telefast® ABE 7 redundant I/O sub-bases.
- 15 ABE 7●16●●●: Advantys Telefast ABE 7 connection sub-bases.
- 16 LA4 DT2U: time-delay relay designed to desynchronize starting of the "Normal" PLC and the "Backup" PLC during simultaneous power-up.
- 17 TSX™ SCP 114: type III PCMCIA card for Modbus Slave communication.
- 18 490 NTC 000●●: crossed cord shielded twitted pair cordsets with RJ 45 connector, for interconnecting TSX ETY 110WS module (shielded twisted pair).
- 19 TSX FP CA●00: Fipio bus trunk cable, shielded twisted pair.
- 20 TSX™ CDP●53: preformed connection cable with HE 10 connector (length = 0.5, 1, 2, 3, or 5 m).
- 21 ABF H20H008: preformed connection cable with HE 10 connector (length = 0.08 m).

**Selection guide: networks, buses and serial links** ..... 5/2

**Selection guide : Web servers and gateways** ..... 5/8

**5.1 - Ethernet network - Transparent Ready®**

- Architecture ..... 5/12
- Embedded Web servers
  - Presentation. .... 5/14
  - Standard Web services ..... 5/16
  - FactoryCast™ Web server ..... 5/18
  - FactoryCast HMI Web server ..... 5/20
  - SOAP/XML Web service ..... 5/26
- Ethernet Modbus®/TCP communication services
  - Presentation. .... 5/27
  - Standard Ethernet services ..... 5/28
  - I/O Scanning service ..... 5/30
  - FDR replacement service for inoperative devices ..... 5/31
  - Global Data service ..... 5/32
  - NTP time synchronization service (Unity™ Pro) ..... 5/33
  - SMTP electronic mail notification service (Unity Pro) ..... 5/34
  - SNMP service protocol. .... 5/35
  - TCP Open optional service. .... 5/36
- Performance ..... 5/38
- Description, characteristics and references
  - Processors with integrated Ethernet port ..... 5/44
  - Ethernet Modbus/TCP modules ..... 5/45
  - EtherNet/IP module ..... 5/46
- ConneXium™, Ethernet wiring system
  - Infrastructure ..... 5/48
  - Connection components ..... 5/50
  - Hub and transceiver ..... 5/52
  - Unmanaged switches ..... 5/54
  - Managed switches ..... 5/57

**5.2 - CANopen machines and installations bus**

- Presentation and connectable devices ..... 5/62
- CANopen PCMCIA card ..... 5/63
- Wiring system ..... 5/65

**5.3 - AS-Interface® sensor/actuator bus**

- AS-Interface master module ..... 5/68
- Cabling system ..... 5/72

---

## 5.4 - X-Way™ bus and network

■ Communication architecture . . . . .	5/74
■ Fipio® bus manager function . . . . .	5/76
■ Fipio bus Agent function . . . . .	5/80
■ Fipway® network . . . . .	5/82
■ Fipio/Fipway optic transceiver . . . . .	5/84
■ Fipio/Fipway wiring system . . . . .	5/86

## 5.5 - Network and fieldbus

■ Modbus Plus® network . . . . .	5/90
■ Profibus DP™ fieldbus . . . . .	5/94
■ InterBUS® fieldbus . . . . .	5/96

## 5.6 - Serial links

■ Modbus® serial link . . . . .	5/100
■ Uni-Telway™ serial link . . . . .	5/104
■ Asynchronous serial links . . . . .	5/108
■ Connecting cables for PCMCIA cards and TER/AUX ports . . . . .	5/110

# Modicon® Premium™ automation platform

## Ethernet CPUs and modules

### Transparent Ready®

**Applications**

Processors with built-in Ethernet Modbus®/TCP port



**Type of network**

**Ethernet Modbus/TCP**

<b>Structure</b>	Physical interface
	Method of access
	Data rate

10BASE-T/100BASE-TX (RJ45)
CSMA-CD
10/100 Mbit/s

**Medium**

CAT 5E double twisted pair cable  
Optical fiber, via Ethernet ConneXium™ wiring system

<b>Configuration</b>	Maximal number of devices
	Maximum length
	Number of networks/station
	Other built-in port

Maximum of 64 stations per network, maximum of 128 stations per network with TSX™ P57 5634M/6634M processors			
100 m (copper cable), 4,000 m (multimode optical fiber), 32,200 m (single mode optical fiber)			
1 integrated Ethernet port	3 (1)	4 (1)	
–	Fipio® bus manager function	–	Fipio bus manager function

<b>Basic services</b>	Services Ethernet
	Services X-Way™
	Ethway™

Uni-TE™ and Modbus/TCP message handling  
Inter-network X-Way™ routing, X-Way/Uni-Telway™ routing, module diagnostics  
–

**Transparent Ready class**

B30

<b>Embedded Web server services</b>	Basic services
	FactoryCast™ services
	Factory Cast HMI services

“Rack Viewer” PLC diagnostics  
“Data Editor” access to PLC variables and data  
–  
–

**Transparent Ready communication services**

I/O Scanning (64 stations, 128 stations with TSX™ P57 5634M/6634M processors), Global data  
–  
SMTP, E-mail notification (via Unity™ Pro function blocks)  
SNMP, network management, bandwidth management  
–  
FDR server for automatic assignment of IP address and network parameters  
–  
–

**Type of processor**

–

**Module format**

Double format processor

**Type of module**

TSX™ P57 1634M TSX P57 2623M TSX P57 2634M	TSX P57 2823M	TSX P57 3623AM TSX P57 3634M	TSX P57 4823M TSX P57 4634M TSX P57 5634M TSX P57 6634M
--	---------------	---------------------------------	--

**Page**

5/44

(1) Including the integrated Ethernet port.

Ethernet Modbus®/TCP modules

EtherNet/IP module



Ethernet Modbus/TCP (continued)

EtherNet/IP

10BASE5 (AUI), 10BASE-T CSMA-CD	10BASE-T, 100BASE-TX (RJ45)
10 Mbit/s	10/100 Mbit/s
Triaxial cable or double twisted pair, Optical fiber, via ConneXium™ wiring system	CAT 5E double twisted pair cable Optical fiber, via Ethernet ConneXium wiring system
Maximum of 64 stations per network	
100 m (copper cable), 4,000 m (multimode optical fiber), 32,200 m (single mode optical fiber)	
1 to 4 depending on processor or slot PLC used	
-	

Uni-TE™ and Modbus/TCP message handling				EtherNet/IP
Inter-network X-Way™ routing, X-Way/Uni-Telway™ routing, module diagnostics				-
Uni-TE message handling, common words, application to application				-
C10	B30	C30	D10	No Web server
"Rack Viewer" PLC diagnostics "Data Editor" access to PLC variables and data				-
"Alarms viewer" "Graphic Data Editor" Display of user Web pages (1.4 Mb available)				-
-				FactoryCast™ HMI services (2)
-				I/O Scanning (64 stations), Global Data
-				NTP time synchronization
-				SMTP, E-mail notification (via Unity Pro function blocks)
SNMP network management				SMTP, E-mail notification (active Web server)
-				SNMP network management
-				SOAP XML Web server
-				SOAP XML Web client/server
-				FDR server for automatic assignment of IP address and network parameters)
TCP Open				TCP Open

Modicon® Premium™ processors TSX P57 1●/57 2●/57 3●/57 4●/57 5●/57 6●

Standard format module

TSX™ ETY 110 WS

TSX ETY 4103

TSX ETY 5103

TSX™ WMY 100

TSX™ ETC 100

5/45

5/45



5/47

(2) FactoryCast HMI services : HMI database, E.mail with automatic sending on events, interpreted math and logic functions, connection to relational databases and simulator tool.



# Modicon® Premium™ automation platform

## Network and bus modules

Applications		Local area network conforming to Modbus® Plus standard	Local area network conforming to Fip
			
Type of network or bus		Modbus Plus	Fipway®
Structure	Physical interface	Modbus Plus standard	Fip standard
	Method of access	Rotating token	Bus managed by bus arbitrator
	Data rate	1 Mbit/s	1 Mbit/s
Medium		Twisted pair	Twisted shielded pair Fiber-optic via transceivers or repeaters
Configuration	Maximal number of devices	32 per segment 64 on all segments	32 per segment 128 on all segments
	Maximal length	450 m per segment 1800 m with 3 repeaters	1000 m per segment 5000 m maxi with repeaters
	Number of links/station	1 max.	1 to 4 depending on the model of processeur
Services	Message handling	<ul style="list-style-type: none"> <li>- Write/read variables</li> <li>- Global database</li> <li>- Peer Cop service</li> </ul>	<ul style="list-style-type: none"> <li>- Uni-TE™</li> <li>- COM/shared table</li> <li>- Application-to-application</li> <li>- Telegram</li> </ul>
Type of processor		Modicon® Premium™ processors	
Nature of module		PCMCIA type III card on processor or slot PLC	PCMCIA type III card on processors (1) or slot PLCs and on TSX™ SCY 21601 module
Type of module		<b>TSX™ MBP 100</b>	<b>TSX™ FPP 20</b>
Pages		5/93	5/83

(1) Except on TSX P57 4634M/5634M/6634M processors with integrated Ethernet port.

**CAN fieldbus**



**Sensor/actuator bus conforming to AS-i standard**



**Modbus® open industrial bus**



**Bus CANopen V4.02**

ISO 11898
CSMA/CA, multi-master 20 Kbit/s...1 Mbit/s according to distance
Twisted shielded pair
127 slaves
From 20 m (1 Mbit/s)...2500 m (20 Kbit/s)
1 max.

**AS-Interface®**

V2 AS-Interface standard
Master/slave 167 Kbit/s
2-wire AS-Interface cable
31 + 31 discrete, analog or security devices
100 m 200 m with repeaters
2 to 8 depending on the model of processor

**Modbus®**

RS 232 RS 485 isolated 20 mA CL	RS 485 isolated
Master/slave 19.2 Kbit/s max.	
Twisted shielded pair	
32 devices max. 48 slave addresses max.	32 devices max. 247 slave addresses max.
15 m in RS 232 1000 m in RS 485 1300 m in 20 mA CL or integrated link	1300 m
See characteristics page 5/101	

- Implicit PDO exchange
- Explicit SDO exchange or CAN function block
- Explicit PDU CAN exchange

Transparency of exchanges with sensor/actuator devices

Modbus master/slave RTU or ASCII  
13 Modbus functions (read/write bits and words, diagnostic...)

Modicon® Premium™ processors (except TSX P57 153)

Premium processors

PCMCIA type III card on Premium processor

Standard format module

PCMCIA type III card inserted on (2)

Standard format module

**TSX™ CPP 110**

5/63

**TSX™ SAY 1000**

5/69

**TSX™ SCP 11● (3)**  
1 built-in link  
TSX SCY 21601



5/102

**TSX™ SCY 11601**

(2) Premium processor and TSX SCY 21601 communication module.  
(3) At the end of reference, replace ● by 1: RS 232, by 2: 20 mA CL or by 4: isolated RS 485.

# Modicon® Premium™ automation platform

## Network, bus and serial link modules

Applications		Local area network conforming to Fip		Uni-Telway™ multicomponent industrial bus	
					
Type of network or bus		Fipio® (Agent)	Fipio (bus manager)	Bus Uni-Telway	
Structure	Physical interface	Fip standard		RS 485 non-isolated	RS 485 isolated
	Method of access	Bus managed by bus arbitrator		Master/slave	
	Data rate	1 Mbit/s		19,2 Kbit/s max.	
Medium		Twisted shielded pair Fiber-optic via transceivers or repeaters		Twisted shielded pair	
Configuration	Maximal number of devices	32 per segment, 128 on all segments (limited to 64 with TSX P57 0●/1● processor )		5 (excluding programming terminal)	28, (96 slaves addresses max.)
	Maximal length	From 1000 m to 15 000 m (depending on the medium use) with repeaters		10 m	1000 m
	Number of links/station	1 max.		1 max.	See characteristics page 5/104
Services	Message handling	<ul style="list-style-type: none"> <li>- Uni-TE™</li> <li>- Periodic data exchange</li> <li>- Application-to-application</li> <li>- Transparent exchange of remote I/O</li> </ul>		<ul style="list-style-type: none"> <li>- Uni-TE Client/Server 240 bytes (128 bytes on terminal port)</li> <li>- Application-to-application 240 bytes (128 bytes on terminal port)</li> <li>- Transparency of devices on X-Way architecture via the master</li> </ul>	
		Type of processors	Modicon® Premium™ processors	TSX™ P57 ●53M/●54M TSX P57 ●823M TSX PCI 57 354M	Premium processors
Nature of module		PCMCIA type III card on processor or slot PLC	Built-in on the processor or slot PLC	Uni-Telway built-in link	Standard format module
Type of module		<b>TSX™ FPP 10</b>	<b>2 Built-in link on processor</b>	<b>1 AUX terminal port</b>	<b>2 TSX™ SCY 21601</b>
Pages		5/81	5/79	5/107	

5



**Uni-Telway™ multicomponent industrial bus**



**INTERBUS® industrial fieldbus**



**Profibus™ industrial fieldbus**



**Bus Uni-Telway (continued)**

RS 232, RS 485 isolated and 20 mA CL
Master/slave
19,2 Kbit/s max.
Twisted shielded pair
2 in RS 232, 28 in RS 485, 16 in 20 mA CL
15 m in RS 232, 1000 m in RS 485 isolated 1300 m in 20 mA CL
See characteristics page 5/104

**INTERBUS®**

RS 485 isolated
Master/slave generation 4
500 Kbit/s
Twisted shielded pair, Fiber-optic, infra-red ...
512 slaves max. with 254 bus terminal blocks max.
400 m max. (inter-station bus)
1 or 2 depending on the type of Modicon® Premium™ processors

**Profibus DP™**

RS 485
Master
9,6 Kbit/s...12 Mbit/s according to length of bus
Twisted shielded pair, Fiber-optic or infra-red
126 slaves
1200 m (9,6 Kbit/s), 4800 m with 3 repeaters 100 m (12 Mbit/s), 400 m with 3 repeaters

- Uni-TE™ Client/Server 240 bytes (128 bytes on terminal port)
- Application-to-application 240 bytes (128 bytes on terminal port)
- Transparency of all devices on X-Way architecture via the master

- Data process implicit exchange
- Pre-processing
- Logical addressing
- Segmentation

- Read/write access for DP slave I/O data
- Data transfer for slave diagnostics
- Parametering and monitoring requests
- Inter-master dialog not supported

Premium processors

PCMCIA type III card on processor or slot PLC and on TSX SCY 21601 module

Premium processors (except TSX™ 57 0●/1●)

Standard format module	PC card on ISA bus	Standard format module
------------------------	--------------------	------------------------

**TSX™ SCP 11●  
(1)**

**TSX™ IBY 100**

**TSX™ IBX 100**

**TSX™ PBY 100**

5/99

5/99

5/95

5/95

(1) At the end of reference, replace ● by 1: RS 232, by 2: 20 mA CL or by 4: isolated RS 485.

**Applications**

**Web Server modules for PLCs**

**FactoryCast™**

**FactoryCast™**



Target products	Type
-----------------	------

TSX™ Micro PLCs	Modicon® M340™ PLCs
-----------------	---------------------

<b>Network/Remote access services</b>	Remote access
	Gateway function
	Serial protocols
	Ethernet protocols
	TCP/IP protocols
Security	

Intranet or via external RAS/modem	
Remote programming, downloading via FTP, access to Web server via Internet browser	
–	
–	
Modbus®/TCP, Uni-TE™	Modbus/TCP
BootP/DHCP, DNS, SNMP agent, SMTP client, NTP client, FTP	
Protection by IP address filtering and passwords	

<b>Web server</b>	Characteristics
-------------------	-----------------

HTTP and FTP server, 8 Mb memory available for user, hosting of user Web pages and documents (Doc, Pdf, Excel)
--

<b>Predefined services</b>	Configuration
	Diagnostics
	Monitoring of variables
	Alarm management

Via Web Designer software or predefined Web pages
System, rack and PLC I/O diagnostics via predefined Web pages
Monitoring of devices and application via animation tables (read/write variables)
Monitoring of PLC and application alarms via predefined Web pages

<b>Customizable services</b>	Graphic views
	Unity Pro operator screen
	User Web pages

Graphic monitoring via animated views (integrated graphic editor)
–
Surveillance graphique par pages Web animées créées par l'utilisateur

<b>Advanced services and HMI</b>	Calculation scripts
	E-mail service
	Data logging
	–
	Database connection
	Report service
	Recipe service

–
Alarm notification by e-mail
–
–
–
–
–

**Application development software**

**Web Designer**

Supplied with each module



<b>References</b>
-------------------

TSX™ ETZ 510	BMX NOE 0110
--------------	--------------

**Pages or catalogs**

TSX Micro™ automation platform	Modicon® M340™ automation platform
--------------------------------	------------------------------------

**Web Server modules for PLCs**

**FactoryCast™**



Modicon® Premium™ PLCs

Modicon® Quantum™ PLCs

Intranet or via external RAS/modem

Remote programming, downloading via FTP, access to Web server via Internet browser

–

–

Modbus®/TCP, Uni-TE™

Modbus/TCP

BootP/DHCP, DNS, SNMP agent, SMTP client, NTP client, FTP  
Protection by IP address filtering and passwords

HTTP and FTP server, 8 Mb memory available for user, hosting of user Web pages and documents (Doc, Pdf, Excel)

Via Web Designer software or predefined Web pages

System, rack and PLC I/O diagnostics via predefined Web pages

Monitoring of devices and application via animation tables (read/write variables)

Monitoring of PLC and application alarms via predefined Web pages

Graphic monitoring via animated views (integrated graphic editor)

–

Graphic monitoring via animated Web pages created by the user

–

Alarm notification by e-mail

–

–

–

–

**FactoryCast HMI**



Modicon Premium PLCs

Modicon Quantum PLCs

Intranet or via external RAS/modem

Remote programming, downloading via FTP, access to Web server via Internet browser

–

–

Modbus/TCP, Uni-TE

Modbus/TCP

BootP/DHCP, DNS, SNMP agent, SMTP client, NTP client, FTP  
Protection by IP address filtering and passwords

HTTP and FTP server, 8 Mb memory available for user, hosting of user Web pages and documents (Doc, Pdf, Excel)

Via Web Designer software or predefined Web pages

System, rack and PLC I/O diagnostics via predefined Web pages

Monitoring of devices and application via animation tables (read/write variables)

Monitoring of PLC and application alarms via predefined Web pages

Graphic monitoring via animated views (integrated graphic editor)

Display in the form of Web pages

Graphic monitoring via animated Web pages created by the user

Arithmetic and logical scripts

Alarm notification by e-mail

Data recorded in the module with time stamping

Direct recording in an SQL®, Oracle®, MySQL® server

Dynamic HTML report management

Management of "Recipe" data (storage and review locally or on remote database)

Supplied with each module



TSX™ ETY 5103

140 NOE 77111

TSX™ WMY100

140 NWM 10000

5/45

Modicon® Quantum™ automation platform

5/45

Modicon® Quantum™ automation platform



# Modicon® Premium™ automation platform

## Web servers and gateways

**Applications**

**Standalone Gateway, Web Server for Remote Access**

**FactoryCast™ Gateway ETG 1000**

**FactoryCast™ Gateway ETG 1000**



**Target products**      Type

Equipment supporting Modbus®      Equipment supporting Uni-Telway™

<b>Network/Remote access services</b>	Remote access
	Gateway function
	Serial protocols
	Ethernet protocols
	TCP/IP protocols
Security	

Intranet or via external Modem, integrated RAS function	
Remote programming, downloading via FTP, access to Web server via Internet browser	
Ethernet to Modbus serial Modem to Modbus serial and Ethernet	Ethernet to Uni-Telway serial Modem to Uni-Telway and Ethernet
Modbus master	Uni-Telway slave
Modbus/TCP	Modbus/TCP, Uni-TE™ (Premium, Micro)
BootP/DHCP, SNMP agent, SMTP client, NTP client, FTP	
Protection by IP address filtering and password	

**Web server**      Characteristics

HTTP and FTP server, 8 Mb memory available for user, hosting of user Web pages and documents (Doc, Pdf, Excel)

<b>Predefined services</b>	Configuration
	Diagnostics
	Monitoring of variables
	Alarm management

Via Web Designer software or predefined Web pages
Diagnostics of serial devices via predefined Web pages
Monitoring of devices and application via animation tables (read/write variables)
-

<b>Customizable services</b>	Graphic views
	Unity Pro operator screen
	User Web pages

Graphic monitoring via animated views (integrated graphic editor)
-
Graphic monitoring via animated Web pages created by the user

<b>Advanced services and HMI</b>	Calculation scripts
	E-mail service
	Data logging
	Database connection
	Report service
	Recipe service

-
Alarm notification by e-mail
-
-
-
-

**Application development software**

**Web Designer**

Supplied with each module



**References**

TSX™ ETG1000	TSX ETG1010
--------------	-------------

**Web site**

[schneider-automation.com](http://schneider-automation.com)

5

**Standalone Gateway, Web Server for Remote Access**

**FactoryCast™ HMI Gateway ETG30●●**



All Modicon® PLCs and third-party equipment supporting Modbus®

Intranet or Modem External modem, integrated RAS	Intranet or Modem Integrated PSTN modem and RAS	Intranet or Modem Integrated GSM modem and RAS
Remote programming, downloading via FTP, access to Web server via Internet browser		
Ethernet to Uni-Telway™ serial Modem to serial Modbus and Ethernet		
Modbus master Modbus/TCP		
DHCP, DNS, SNMP agent, SMTP client, NTP client, FTP Protection by IP address filtering and password		
HTTP and FTP server, 32 Mb memory available for user Web pages, memory extension using Compact Flash cards 1 Gb max., hosting of user Web pages and documents (Doc, Pdf, Excel)		
Via Web Designer software or predefined Web pages		
Network diagnostics, diagnostics of serial and Ethernet devices via predefined Web pages		
Monitoring of devices and application via animation tables (read/write variables)		
-		
Graphic monitoring via animated views (integrated graphic editor)		
-		
Graphic monitoring via animated Web pages created by the user		
Arithmetic and logical scripts		
Alarm notification by e-mail/SMS		
Data logging in the module with time stamping (CSV files)		
Direct recording in an SQL, Oracle, MySQL server		
Dynamic HTML report management		
Management of "Recipe" data (storage and review locally or on remote database)		

**Web Designer**

Supplied with each module



TSX™ ETG3000	TSX ETG3010 (PSTN modem)	TSX ETG3021 (GSM 900/1800 MHz band) TSX ETG3022 (GSM 850/1900 MHz band)
--------------	--------------------------	--

[schneider-automation.com](http://schneider-automation.com)

# Modicon® Premium™ automation platform

## Ethernet Modbus®/TCP network

### Logical Ethernet communication architecture

Company

Enterprise

Factory

Workshop

5

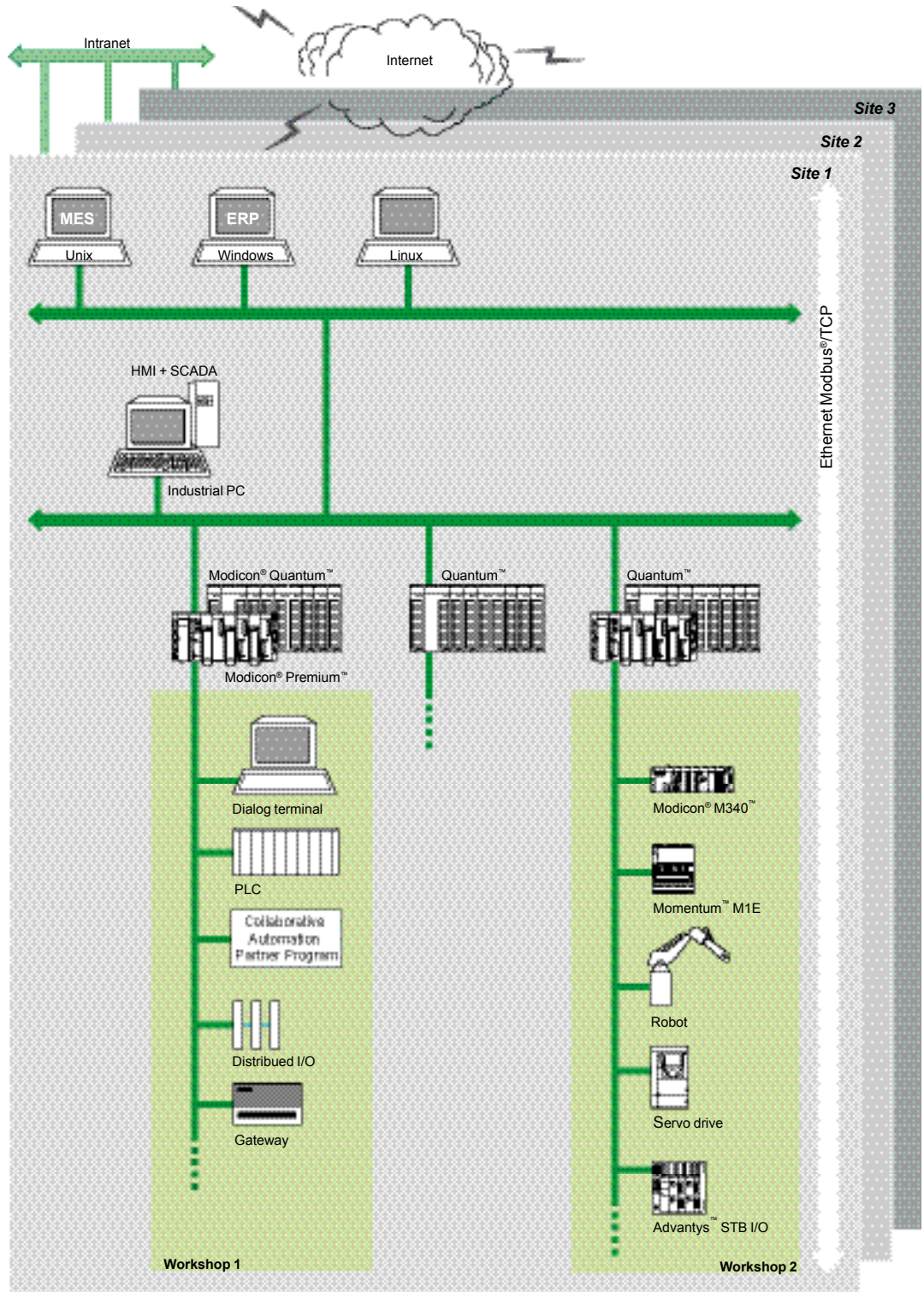

**MES:** Manufacturing Execution System (production management system)  
**ERP:** Enterprise Resource Planning (integrated management software packages)  
**HMI/SCADA:** Human/Machine Interface/Supervision Control And Data Acquisition  
**Gateway:** Bridge to sensor/actuator bus, to installed base network, field bus, etc.

# Modicon® Premium™ automation platform

## Ethernet Modbus®/TCP network

### Physical Ethernet communication architecture

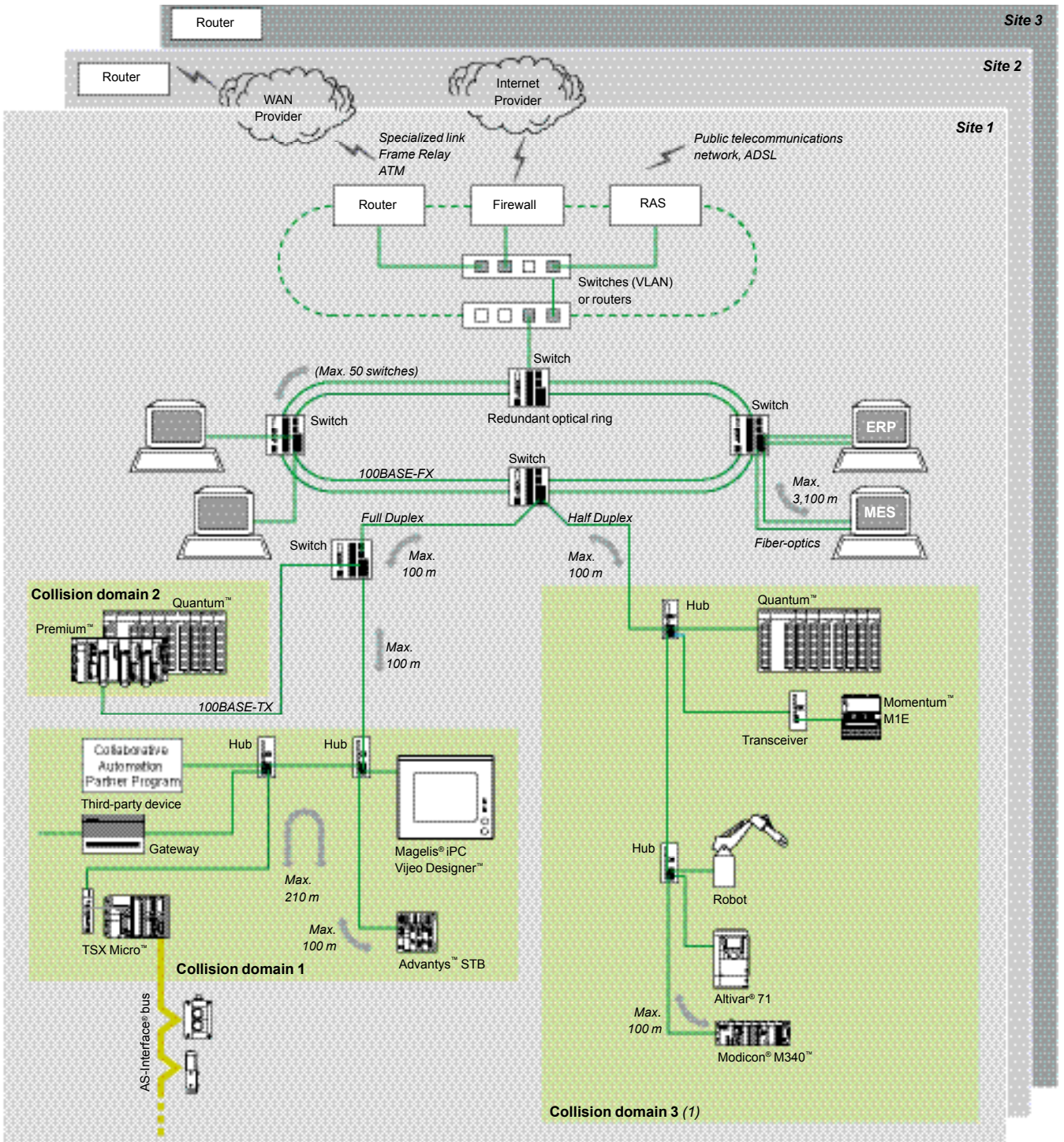

(1) In general, several collision domains should be defined in order to increase the architecture surface and improve performance. See pages 9/12 to 9/17.

# Modicon® Premium™ automation platform

## Transparent Ready®, system approach

### FactoryCast™ Web servers and gateways

5

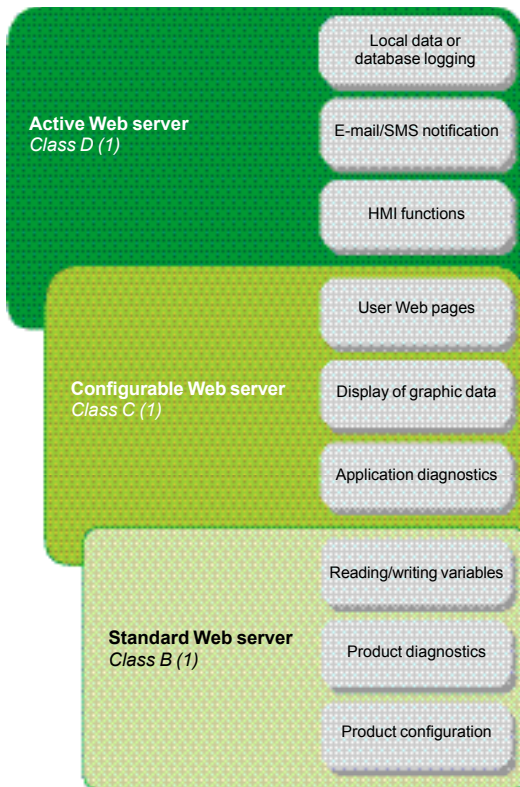

#### FactoryCast™ Web server offer

Schneider Electric offers a wide range of Transparent Ready® products: controllers and PLCs, industrial PCs, HMI devices (2), variable speed drives, distributed I/O modules, gateways, Web servers, switches, SCADA software, inductive identification systems, etc.

These products provide different levels of Web services and communication services on Ethernet, according to user requirements.

Among these Transparent Ready products, FactoryCast™ defines a range of modules and gateways with configurable Web server combining:

- Real-time communication functions based on Ethernet Modbus®/TCP
- Predefined Web pages for advanced installation diagnostics
- And the capacity to host dynamic user-defined Web pages or any document (.doc, pdf, etc) designed to assist maintenance

#### Presentation of the Web server modules and gateways

In the Transparent Ready approach, Ethernet modules and Web gateways integrate Ethernet services (Modbus/TCP messaging, SNMP network management functions, etc.) They also offer, depending on the product, the following Web functions:

- Standard Web services (predefined)
- FactoryCast configurable Web services
- FactoryCast HMI active Web services

There are two ranges of configurable Web server:

■ **FactoryCast Web modules for PLCs**, which are embedded in the TSX Micro™, Modicon® Premium™, Quantum™ and M340™ automation platforms. These modules provide transparent access to system and application diagnostic information in real time using Web technologies.

■ **FactoryCast Web Gateway modules**, with the network interfaces in one stand alone unit:

- A modem (depending on the version)
- An RAS/Router function
- A customizable Web server
- HMI functions (depending on the version)

FactoryCast Gateways are a cost-effective response to requirements for remote access to customized remote diagnostics, maintenance, monitoring and control services using a simple Internet browser as well as to requirements to integrate serial installations (Modbus RTU or Uni-Telway) in an existing Ethernet Modbus/TCP infrastructure.

#### Presentation of the Web services

##### Standard Web services

Standard Web services are integrated in the following Schneider Electric Ethernet products: automation platform processors and Ethernet modules, distributed I/O modules, variable speed drives and Ethernet gateways. See page 9/15 in this catalog.

Using a simple Internet browser, the standard Web server provides the following "ready-to-use" functions:

- Product configuration
- Remote diagnostics and maintenance of products
- Display and adjustment of products (read/write variables, status)

The embedded Web server is a real-time data server. The data can be presented in the form of standard Web pages in HTML format and can therefore be accessed using any Web browser that supports the embedded Java® code. The standard functions provided by the Web server are supplied "ready-to-use" and therefore do not require any programming of either the PLC or the client PC device supporting a Web browser.



(1) In order to simplify choice and to help ensure their interoperability within a system, each Transparent Ready product is identified by the class of services it provides. Letter A, B, C or D (level of service for the Web server) followed by 10, 20 or 30 (level of service for Ethernet communication).

(2) HMI = Human Machine Interface.





## Presentation of the Web services (continued)

### FactoryCast™ configurable Web services

The configurable Web services are integrated in the following Schneider Electric Ethernet products: FactoryCast™ PLC modules (TSX Micro™, Premium™ and Quantum™) and FactoryCast Gateway modules.

In addition to the standard Web services, the configurable Web servers offer the following functions:

- Graphic application diagnostics (customized graphic views created by the user).
- Graphic monitoring via animated Web pages created by the user and stored in the Web server module.
- And depending on the products:
  - Management of PLC system and application alarms with partial or total acknowledgement (ready-to-use Alarm Viewer function pages).
  - Open data server interface. SOAP/XML protocol, WSDL interface (1).

FactoryCast Web servers can also be used to customize the supervision, diagnostics or maintenance interface via user-defined Web pages or any other document (doc, pdf, etc.) hosted in the module.

### FactoryCast™ HMI active Web services

The active Web services are integrated in the Premium and Quantum FactoryCast HMI PLC modules.

In addition to the FactoryCast Web services, the FactoryCast HMI modules provide HMI functions, which are executed in the module itself:

- Real-time HMI database management, independent of the PLC processor
- Arithmetic and logical calculations based on HMI data
- Direct connectivity with relational databases (traceability)
- Data Logging: recording of data in the module
- Display of Unity Pro graphic runtime screens in the form of Web pages
- Recipe management (read/write)
- Alarm and report notification by e-mail
- Active page server, dynamic generation of animated HTML pages
- Dynamic generation of HTML reports
- Open data server interface SOAP/XML WSDL interface protocol (1).

FactoryCast HMI is defined as an active Web server used to execute HMI functions without any effect on the PLC application program and therefore on its scan time.

(1) Standard protocol providing interoperability with computer management applications (see pages 5/26).



## Web server products

Product	Reference	Embedded Web server			
		Standard, class B20	Configurable, class C20/C30	Active, class D10 (2)	
Modicon® Quantum™ platform	Processors	140 CPU 651 50/60	–	–	
		Modules	140 NOE 771 01	–	–
			140 NOE 771 11	FactoryCast	–
		140 NWM 100 00	FactoryCast	FactoryCast HMI	
Modicon® Premium™ platform	Processors	TSX™ P57 2●23 M	–	–	
		TSX P57 3623 M	–	–	
		TSX P57 4823 M	–	–	
		TSX P57 1634 M	–	–	
		TSX P57 ●634 M	–	–	
	Modules	TSX™ ETY 4103	–	–	
		TSX ETY 110WS	–	FactoryCast	
		TSX ETY 5103	–	FactoryCast	
	TSX™ WMY 100	–	FactoryCast HMI		
Modicon® M340™ platform	Module	BMX NOE 0110	–	FactoryCast	
Modicon® TSX Micro™ platform	Modules	TSX™ ETZ 410	–	–	
		TSX ETZ 510	–	FactoryCast	
Inductel identification station		XGK S1715503	–	–	
FactoryCast™ Web Gateway		TSX™ ETG 10●0	–	FactoryCast	
FactoryCast™ HMI Web Gateway		TSX ETG 30●●	–	FactoryCast	FactoryCast HMI

(2) Class D20 for TSX ETG 30●●

# Modicon® Premium™ automation platform

Transparent Ready®, system approach  
Modicon PLC standard Web services

## Modicon® PLC standard Web services

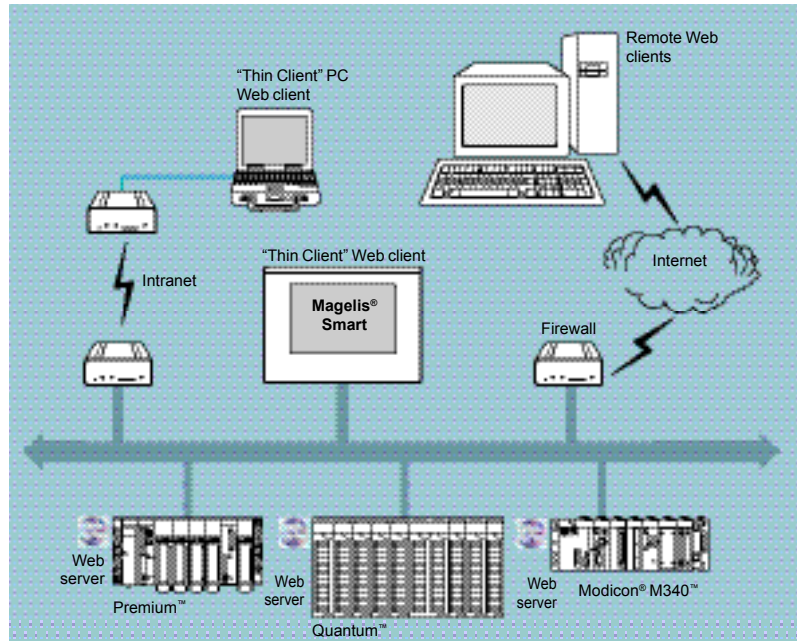

The predefined “Rack Viewer” PLC diagnostic function and the “Data editor” read/write function are supported by all Ethernet Modbus®/TCP modules (1) in the following Modicon® automation platforms:

- Premium™
- Quantum™
- M340™
- Momentum™
- TSX Micro™

See the selection of Web server products on page 5/15.

These functions can be accessed using a standard Internet browser connected to the network. They are “ready to use” and secure (password-protected).

They can be used locally or remotely via:

- Intranet
- Modem and RAS server
- Internet

(1) For standard Web servers integrated in variable speed drives, please consult our catalog “Soft starters and variable speed drives”.



Modicon® Quantum™ hardware configuration

### Modicon® PLC standard Web services (continued)

#### “Rack Viewer” PLC diagnostics function

The “Rack Viewer” function (PLC rack display) can be used for PLC system and I/O diagnostics. It displays the following in real time:

- LED status on the front panel of the PLC
- The PLC type and version
- The hardware configuration of the PLC including the status of the system bits and words
- Detailed diagnostics of each I/O module channel or application-specific channel in the configuration

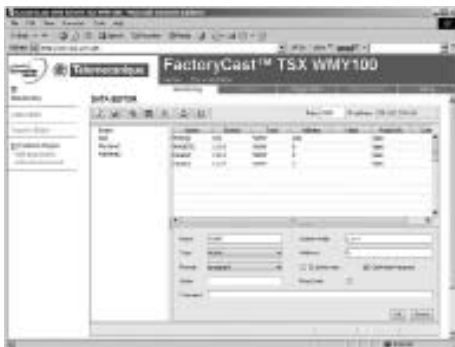

Data editor variables table

#### “Data Editor” read/write function for PLC data and variables

The “Data Editor” function can be used to create tables of animated variables for real-time read/write access to lists of PLC data.

Various animation tables, containing specific application variables to be monitored or modified, can be created by the user and saved in the standard Web server module.



In addition to the functions provided by standard Web servers, FactoryCast™ Web servers offer the following:

- Variables to be displayed can be entered and displayed using their symbol (S\_Pump 234) or their address (%MW99)
- The write access option for variables can be enabled or disabled for each of the variables using the FactoryCast configuration software.
- The read/write function can be used on tools such as “pocket” PC or PDA terminal.



## FactoryCast™ configurable Web server

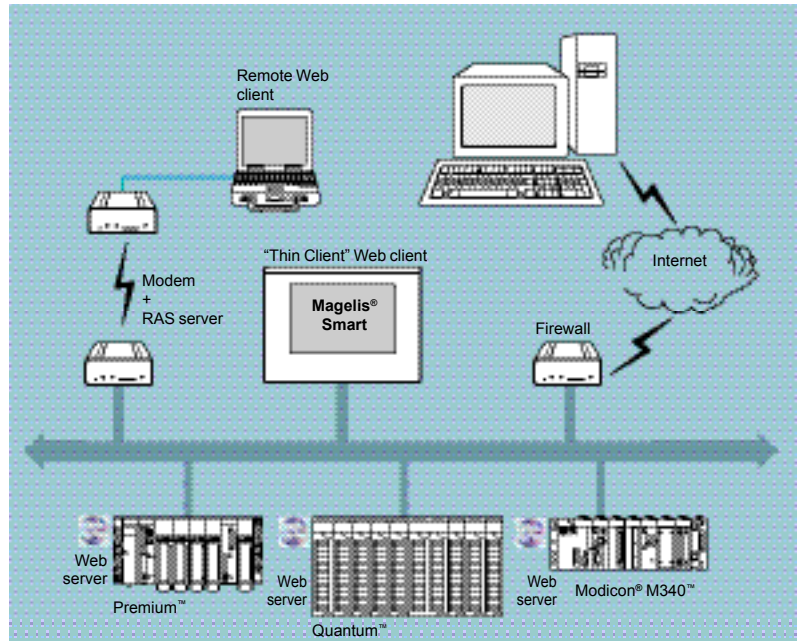

In addition to standard Web services, FactoryCast modules (see selection table on page 5/15) support the following functions:

- Alarm Viewer
- Creation and display of graphic views via an online graphics editor (Graphic Data Editor, supplied)
- Hosting and display of Web pages created by the user
- SOAP/XML server interface

5



### Alarm viewer function

The alarm viewer is a “ready to use”, password-protected function. This function can be used to process alarms (display, acknowledgment and deletion) managed at PLC level by the system or using diagnostic function blocks known as DFBs (system-specific diagnostic function blocks and application-specific diagnostic function blocks created by the user).

These alarms are stored in the PLC diagnostic buffer (specific memory area used to store diagnostic events). This function is available with the Premium™ platform (with PL7™ or Unity™ software) and the Quantum platform (with Unity software). The diagnostics viewer consists of a Web page displaying a list of messages with the following information for each alarm:

- Dates and times of the appearance/disappearance of the detected fault
- Alarm message
- Alarm status
- Type of associated diagnostic function block (DFB)

# Modicon® Premium™ automation platform

Transparent Ready®, system approach  
Modicon PLC standard Web services

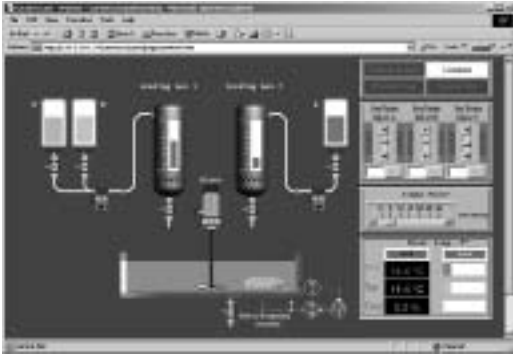

## FactoryCast™ configurable Web server (continued)

### User Web page hosting and display function

FactoryCast Web modules have an 8 Mbyte memory (1) which is accessed in the same way as a hard drive and can be used to host Web pages and user-defined documents in Word or Acrobat Reader (for example, maintenance manuals, diagrams, etc.).

These Web pages can be created using any standard tool for creation and editing in HTML format. These pages can be enhanced by inserting animated graphic objects linked to PLC variables. These animated objects are created using the Graphic Data Editor supplied with FactoryCast.

The Web pages created can be used, for example, to:

- Display and modify PLC variables in real time
- Create hyperlinks to other external Web servers (documentation, suppliers, etc)

This function is particularly suitable for creating graphic interfaces used for the following purposes:

- Real-time display and supervision
- Production monitoring
- Diagnostics and help with maintenance
- Operator guides

### SOAP/XML server interface

FactoryCast modules incorporate a standard SOAP/XML data server that provides direct interoperability between automation devices and computer management applications (MES, ERP, SAP, .Net application, etc.). See page 5/26.

### Graphic Data Editor function

This function can be used to create graphic views animated by PLC variables. The graphic editor is available online “ready to use”, and also offline using FactoryCast configuration software.

- These views are created by simple copy/paste operations, using a library of predefined graphic objects. The object parameters are set according to user requirements (colors, PLC variables, labels, etc.). List of graphic objects provided:
  - Analog and digital indicators
  - Horizontal and vertical bar charts
  - Boxes for displaying messages and entering values
  - Pushbutton boxes
  - Functions for recording trends
  - Tanks, valves, motors, etc.

Customized graphic objects can be added to this list. They can be reused in user Web pages that have been created using standard software for editing HTML pages.

The views created can be saved in the FactoryCast modules.

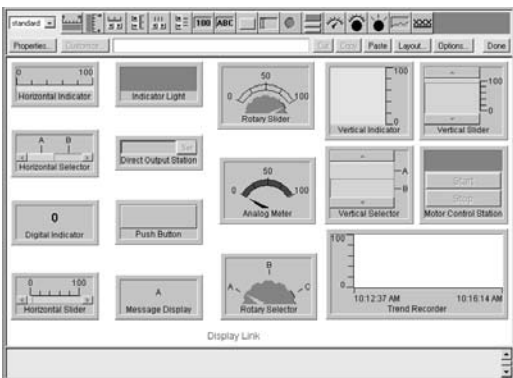

(1) Memory is not affected by power outages or reinitialization of the PLC

# Modicon® Premium™ automation platform

Transparent Ready®, system approach  
FactoryCast™ HMI active Web services



## FactoryCast™ HMI active Web servers

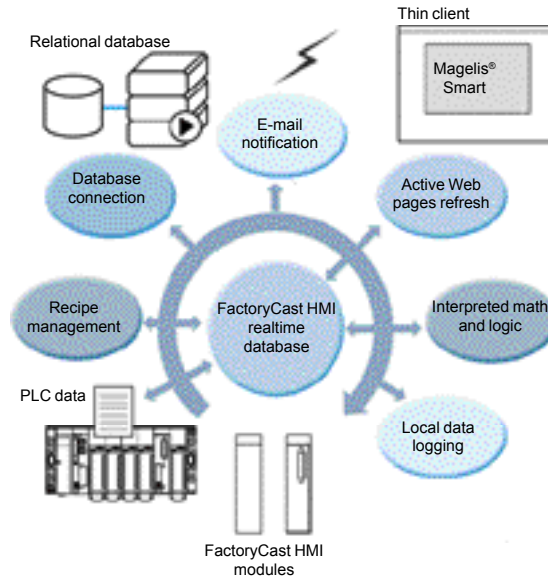

FactoryCast HMI Web services are integrated in the Web server modules embedded in the Modicon® Premium™ and Quantum™ automation platforms.

5

These modules have the following Ethernet and Web services:

- Ethernet TCP/IP communication functions:
  - TCP/IP messaging service with Modbus® TCP/IP and Uni-TE™ TCP/IP protocols
  - SNMP agent for standardized network management supports standard MIB II and Transparent Ready private MIB.
- FactoryCast configurable Web services:
  - “Rack Viewer” PLC diagnostics functions (see page 5/17)
  - “Data editor” read/write functions for PLC variables(see page 5/17)
  - “Alarm viewer” alarm display functions (see page 5/18)
  - “Graphic Data Editor” online graphic view editor functions(see page 5/18)
  - Function for hosting and displaying user Web pages (see page 5/19)

FactoryCast HMI modules also provide the following specialized HMI Web services:

- Real-time HMI database management, independent of the PLC processor
- Arithmetic and logical calculations on HMI data
- Direct connectivity with relational databases (traceability)
- Data Logging: recording of data in the module
- Display of Unity™ Pro graphic runtime screens in the form of Web pages
- Recipe management (read/write)
- E-mail notification for alarms and reports
- Active page server, dynamic generation of animated HTML pages
- Dynamic generation of HTML reports
- Open data server interface. SOAP/XML WSDL interface protocol (1).

(1) In order to simplify choice and to help ensure their interoperability within a system, each Transparent Ready product is identified by the class of services it provides. Letter A, B, C or D (level of service for the Web server) followed by 10, 20 or 30 (level of service for Ethernet communication).

# Modicon® Premium™ automation platform

Transparent Ready®, system approach  
FactoryCast™ HMI active Web services

## Architectures

FactoryCast™ HMI Web servers can be integrated in various architectures:

- Installations that require a flexible distributed HMI solution.
- Combined architectures supplementing conventional SCADA systems
- Architectures where a direct link is required between automation systems and information management levels (IT link).

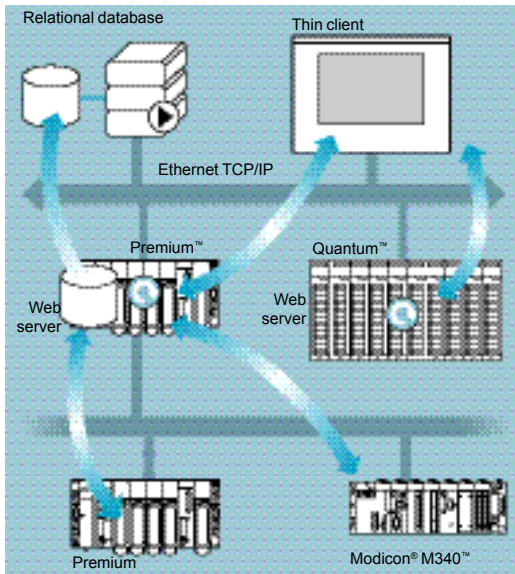

## Flexible distributed HMI solution

The use of Web-based technologies means that FactoryCast HMI can replace conventional HMI or SCADA solutions in applications where architectures require a flexible multistation HMI, thus providing a temporary "nomadic" remote control function.

These architectures consist of:

- Several PLCs networked on Ethernet, equipped with FactoryCast HMI Web server modules
- One or more PC terminals simply equipped with a Web browser thus providing a "Thin Client" interface (licence free).
- Optionally, a relational database where FactoryCast HMI can archive data from the automation system.

FactoryCast HMI modules read PLC data and execute HMI services (e-mail, interpreted calculations, connection to relational databases, updating Web pages) at source in the PLC, without affecting the PLC program or the scan time.

This solution provides:

- A reliable HMI application, which is executed at source in a robust PLC device
- An integrated multistation interface and remote access that is easy and cost-effective to set up ("Thin Client" terminal, for example Magelis® Smart).
- An HMI application that is easy to maintain (the application is housed in a single location on the server side)
- Preventive maintenance via e-mail
- Greater availability for archiving data in the PLC

# Modicon® Premium™ automation platform

Transparent Ready®, system approach  
FactoryCast™ HMI active Web services

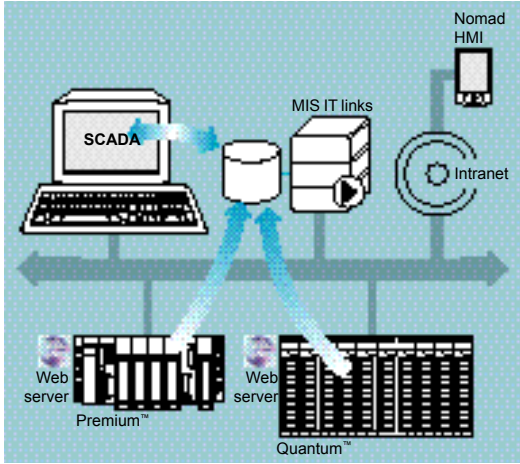

## Architectures (continued)

### Combined architectures

In this type of architecture FactoryCast™ HMI supplements conventional SCADA systems, such as Vijeo® Look or Monitor Pro™, which meet the requirement for centralizing information for global supervision from a central site.

Combining a FactoryCast HMI solution and a conventional SCADA solution enables:

- Simplification of the SCADA application by locating some of the SCADA processing functions at source, at PLC level
- Increased availability of the traceability function due to the direct connection between FactoryCast HMI modules and relational databases
- Powerful "ready to use" remote diagnostics capacities
- "Nomadic" client stations to be connected to the Intranet or Internet via "Thin Client" PC or PDA devices

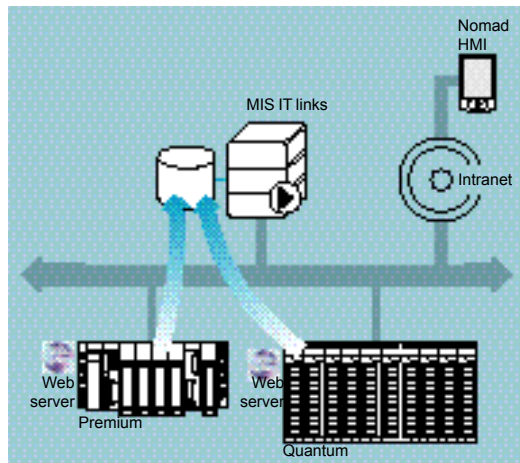

### Direct links with the information management levels

In this type of architecture FactoryCast HMI eliminates the need for intermediate devices (software or hardware gateways), which are expensive to install and maintain, by establishing direct links between the automation levels and the global information management levels (MES, ERP, etc.).

The PLC manages the following links which allow a "collaborative" automation system to be set up, making it easier to share data in real time:

- Directly archives information from the automation system in relational databases
- Directly interacts with IT applications via the SOAP/XML client/server interface

This solution results in:

- Simplified architectures
- Lower installation, development and maintenance costs
- Increased reliability of information (the data is collected at source)
- Increased interoperability with IT applications
- Greater availability of data archiving



# Modicon® Premium™ automation platform

Transparent Ready®, system approach  
FactoryCast™ HMI active Web services



## Specialized HMI services

### Real-time database

With an internal architecture similar to that of an HMI/SCADA system, FactoryCast™ HMI modules manage their own variables databases in real time, independently of the PLC program. It is these variables databases that are used to execute various functions, including internal processing, archiving, alarms and e-mail, etc.

Variables in this real-time database are updated using the PLC's data acquisition service.

This service becomes operational once the following parameters have been set in the FactoryCast HMI software:

- Direct import of PLC variable/symbol databases (no double entry)
- Definition of the frequency of acquisition (period at which this variable is updated)

**Note:** A FactoryCast HMI application running in a Premium configured FactoryCast HMI module can access the PLC variables in the architecture transparently on the network (X-Way/Uni-TE™ transparent protocols).

### Characteristics

- Maximum number of I/O variables per application: 1000 variables from PLCs
- Maximum number of internal variables per application: 100
- Acquisition frequency: 500 ms minimum



### Calculation functions

The FactoryCast HMI server can carry out various arithmetic or logical operations on a combination of variables from the HMI database. These calculations include, for example, scaling, formatting, logic processing for event triggering, etc.

This calculation function is operational from the local HMI database, independently of the PLC processor, and is in the form of spreadsheets where the formulas are defined in cells.

These spreadsheets are interpreted and processed by the server. The result of each formula is associated with a new internal variable. The processing of each spreadsheet is initiated by a trigger.

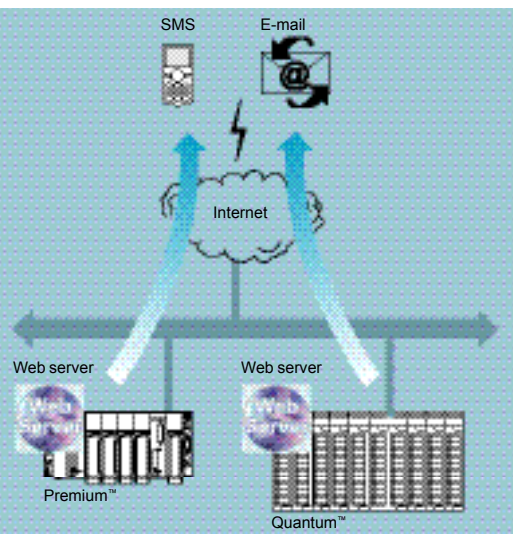

### E-mail transmission

The FactoryCast HMI module can, on a specific event, send e-mails completely autonomously to a predefined list of e-mail addresses. This function is executed independently of the PLC program.

The event that triggers the e-mail may be associated with the following:

- A PLC variable (I/O, internal variable)
- An alarm, a threshold overshoot
- A machine or process state
- An operator action, etc.

When an e-mail is sent it passes via an SMTP (Simple Mail Transfer Protocol) server. This server receives the e-mail and waits for the recipient to acknowledge it. The e-mail service is compatible with SMTP servers. A return address can be defined should delivery to the destination address fail.

### Characteristics

- Configuration of the SMTP server: compatible with SMTP servers
- Maximum number of e-mails: 100
- Contents of e-mail messages: free text with embedded dynamic variable values (from the PLC) and hyperlinks (unlimited).

E-mail transmission

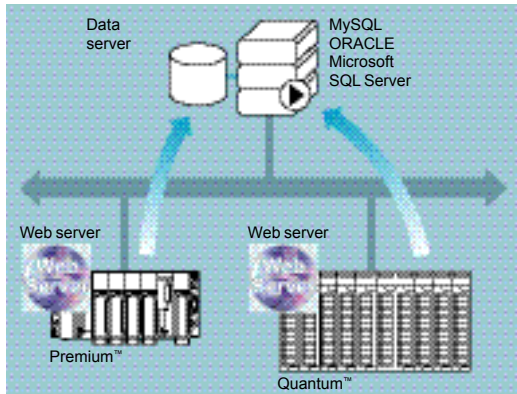

Connection to databases

### Specialized HMI services (continued)

#### Connection to relational databases

The FactoryCast™ HMI module can be connected directly and completely autonomously to the following remote relational databases:

- SQL Server®
- MySQL®
- Oracle®

This connection enables process or internal data to be archived directly in the FactoryCast HMI module without any intermediate system (hardware or software).

The data can be archived (written) periodically and/or on a specific event. These variables can either be from PLCs(I/O bits, internal bits, internal words and registers), or local to the module.

The FactoryCast HMI “Roll over” function checks the size of tables by managing the maximum number of records. This circular data archiving function automatically deletes the oldest data and can be accessed by simply setting parameters in the FactoryCast HMI software.

#### Characteristics

- Number of databases that can be connected: 3.
- Number of tables that can be written per database: 10 maximum
- Number of columns per table: 50 maximum
- Type of database supported: Oracle, SQL Server and MySQL
- Automatic table creation: the FactoryCast HMI server creates a table in the database if one does not already exist

#### Data Logging

FactoryCast HMI modules can record data in the internal flash memory periodically or on an event.

This record is created in a CSV file, which can be:

- Automatically exported via FTP
- Attached to an e-mail

This function is particularly useful for standalone installations, or stations that are not connected to an Intranet, or for local traceability of data.

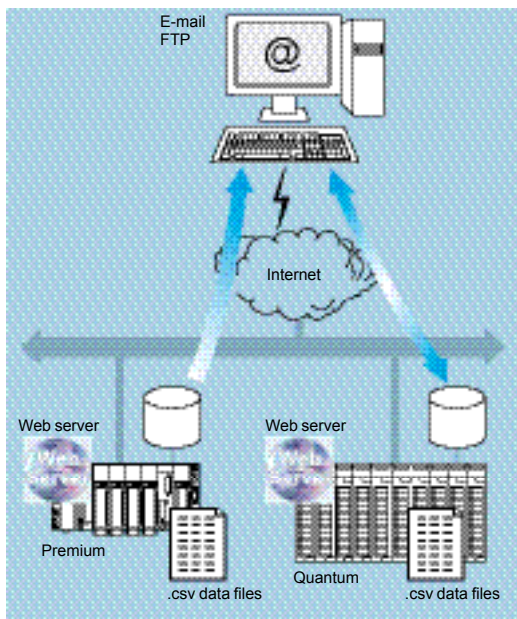

Data Logging

# Modicon® Premium™ automation platform

Transparent Ready®, system approach  
FactoryCast™ HMI active Web services

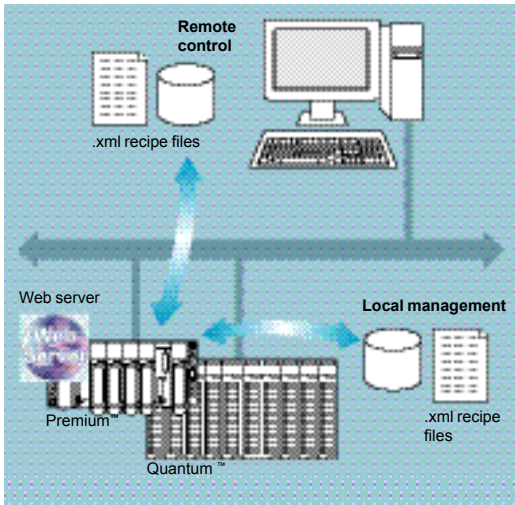

Recipe management

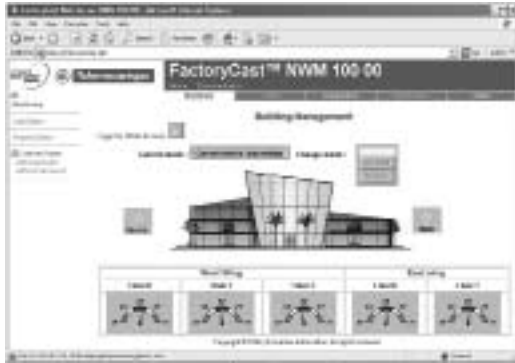

## Specialized HMI services (continued)

### Recipe management

The recipe management function enables a FactoryCast™ HMI application to take recipe files into account automatically on process events or at the request of an operator, applying the recipe values to the PLC data memory.

This function provides very flexible data management in the execution of production or process changes by sending new setpoints and new parameters.

### Characteristics

- Recipes are described using XML® format (SOAP/XML format)
- Recipes are stored in the module or remotely
- Recipes contain setpoint values in accordance with "standard" recipes, and these values are transferred to the PLC memory.

### Web based HMI interface

The memory of the FactoryCast HMI Web server receives Web pages defined by the user to provide a graphic HMI interface. The Active Web Server provides dynamic refreshing of the Web pages generated by the server itself.

FactoryCast HMI supports two types of Web page:

- HTML pages animated in real time with Java® graphic objects used to create the user interface (FactoryCast HMI comes with a complete library of Java graphic objects).
- Active Web pages dynamically generated in the Web server with integration of PLC variables inside the HTML code (PLC "tags") which can be used to generate reports. These active pages consisting of HTML code are fully compatible with all "Thin Client" terminals (pocket PC, PDA, or PC terminal).

5

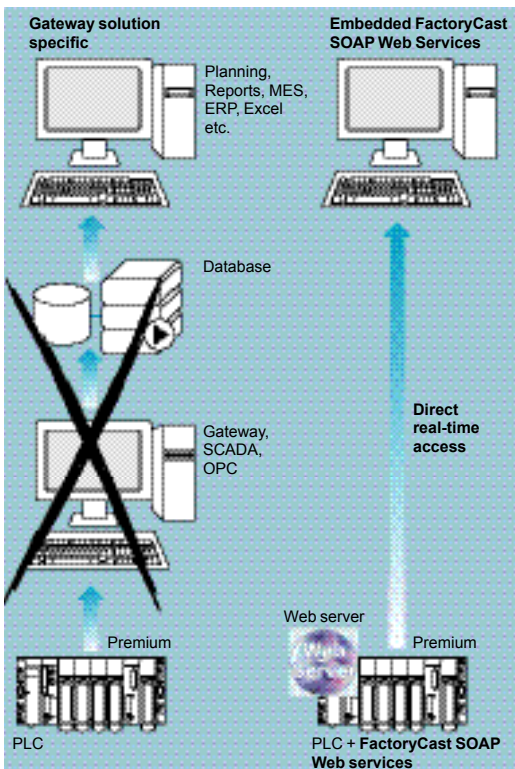

SOAP/XML client/server interface

### SOAP/XML client/server interface

For total interoperability, FactoryCast HMI implements SOAP/XML Web service: server function capable of answering SOAP requests generated by any client application (MES, ERP, SAP, SCADA or third-party applications developed in .NET® or Java).

See page 5/26.



### Presentation, functions

The standardization of Web services has come about as a result of joint development between Microsoft® and IBM®, amongst others, validated at the W3C® (World Wide Web Consortium) as an open “standard”.

It now provides the tools, specifications and environments needed for each platform. Web services are based on standards such as:

- **XML** (eXtensible Markup Language): the universal standard for data exchange
- **SOAP** (Single Object Access Protocol) protocol carried via the **HTTP** (Hyper Text Transfer Protocol) channel.
- **WSDL** (Web Services Description Language) the Web Services description language, in XML format.

SOAP is currently considered to be the reference protocol, including in industry. It has since been adopted by the main players such as Microsoft® (•NET®, SQL Server®, Office®, etc), IBM® (Java®, WebSphere®, Lotus®), ORACLE®, Sub, SAP®, ...

### Embedded SOAP/XML Web Services: Modbus®XMLDa Web services

This new Transparent Ready® service offers the previously unused (or uncommon) possibility of making an IT/e-business application interact directly with the control system levels using the same standards.

With the implementation of Modbus®XMLDa (Modbus XML Data access) Web services in FactoryCast Web servers, the IT engineer can easily create his own application which will access the desired information directly in the PLC and in real time.

Data exchanges are made in XML standard format in response to a request using SOAP protocol.

The implementation of Web services in control system equipment makes it easy to achieve vertical integration of the control level and the creation of even more collaborative architectures which can be used to link production systems to the corporate management systems. It brings simplified access to information, a reduction in the costs of training, development and deployments costs, plus an increase in productivity.

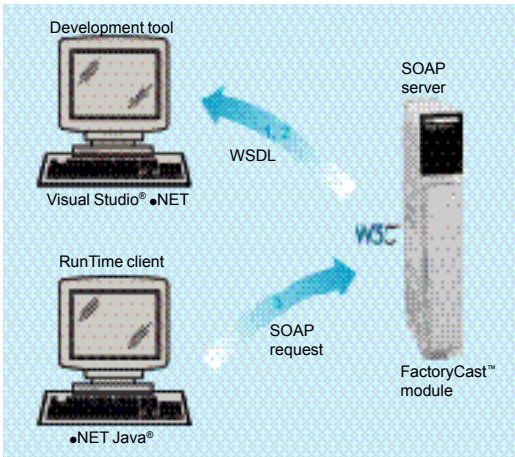

ModbusXMLDa server interface

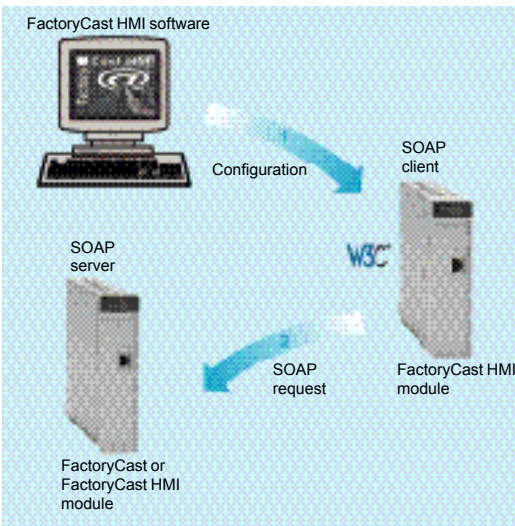

ModbusXMLDa client interface

### ModbusXMLDa Web services in FactoryCast™ modules

#### ModbusXMLDa server interface

This implementation enables a SOAP client application (management level computer application, MES, ERP, etc) to communicate directly with a FactoryCast Web server module embedded in the PLC.

Exchanges are initiated by the SOAP client application (the server responds to these requests).

#### □ Step 1: Creation of the client application with learning of the Web services.

The development environment (for example, Visual Studio® •NET) looks in the FactoryCast server for the list of available services and their WSDL standard interfaces provided by the module.

□ **Step 2: Development of the client application.** The developer integrates the Web service functions using the code retrieved at the learning stage.

□ **Step 3: Execution of the client application.** The client application communicates in real time with the FactoryCast Web server module using the SOAP protocol.

#### ModbusXMLDa client interface

This implementation allows a FactoryCast™ HMI module to execute a SOAP client application in order to communicate with a remote SOAP server application (for example another FactoryCast Web server module or a computer management application, MES, ERP, etc).

Exchanges are initiated by the FactoryCast HMI client module (the remote application server responds to SOAP requests sent by the FactoryCast HMI module).

□ **Step 1: Configuration of ModbusXMLDa client service.** The user declares the PLC variables that are to be exchanged (in read or write mode), using the FactoryCast HMI configuration software.

□ **Step 2: Use of the application. ModbusXMLDa client service** executed in the FactoryCast HMI module communicates directly with the remote server application using SOAP requests in XML format.

ModbusXMLDa functions are implemented on the following FactoryCast modules:

- Server interface: Modicon M340: **BMX NOE 0110**, Premium: **TSX ETY 5103/WMY 100** and Quantum: **140 NOE 771 11/NWM 100 00**,
- Client interface: Premium: **TSX WMY 100** and Quantum: **140 NWM 100 00**

Request implemented	ModbusXMLDa functions implemented in FactoryCast modules
Access to data via physical address	ReadDeviceIdentification
	ReadMultipleRegisters
	WriteMultipleRegisters
	ReadCoils
	WriteMultipleCoils
	ReadDiscreteInputs
Access to data via symbol	Read, operation to read item list value
	Write, operation to write item list value
	Browse, operation to browse item list

# Modicon® Premium™ automation platform

## Transparent Ready®

### Ethernet Modbus®/TCP communication service

#### Presentation

Transparent Ready® products allow transparent communication on a single Ethernet Modbus®/TCP network.

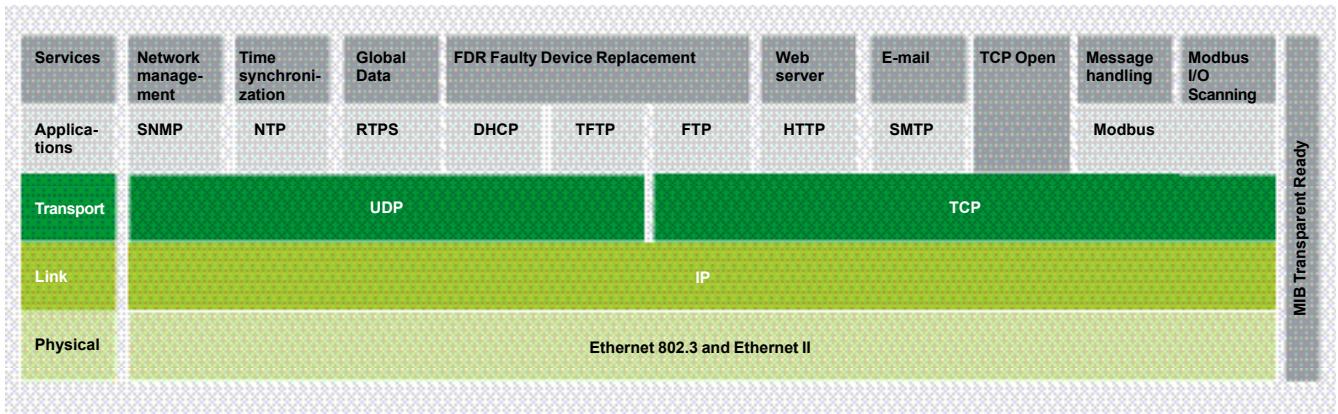

In addition to universal Ethernet services (HTTP, BOOTP/DHCP, FTP, etc), the Transparent Ready device communication services designed for use in automation applications include:

- Modbus/TCP messaging for class 10, 20 or 30 devices.
- I/O Scanning service for class 30 devices.
- FDR (Faulty Device Replacement) for class 10, 20 or 30 devices.
- SNMP (Simple Network Management Protocol) network administration for class 20 or 30 devices.
- Global Data, for class 30 devices.
- Module Bandwidth Monitoring for class 30 devices
- NTP (Network Time Protocol) time synchronization for class 30 devices.
- E-mail notification of application events via SMTP for class 30 devices.
- TCP Open, optional, for class 30 devices.

*Note : For details of supported services, see pages of characteristics for each product.*

The following pages present the various options provided by these services in order to facilitate the optimum choice of solutions when defining a system integrating Transparent Ready devices.

**Functions** (continued)

**Standard Ethernet services**

**HTTP** "Hypertext Transfer Protocol" (RFC1945)

The HTTP protocol "Hypertext Transfer Protocol" is used for transmitting Web pages between a server and a browser. HTTP has been used on the Web since 1990. Web servers embedded into Transparent Ready® devices are used to provide easy access to devices anywhere in the world from a standard browser such as Internet Explorer® or Netscape Navigator®.

**BOOTP/DHCP** (RFC1531)

BOOTP/DHCP is used to automatically provide the devices with the IP parameters. This avoids having to manage the addresses of each device individually. Management is instead performed in a dedicated IP address server. DHCP protocol (Dynamic Host Configuration Protocol) is used to automatically assign the devices their configuration parameters. DHCP is an extension of BOOTP. DHCP protocol is made up of 2 components:

- One for providing the IP network address,
- One for providing the IP parameters specific to the device from a DHCP server.

*Schneider Electric devices can be:*

- BOOTP clients allowing automatic recovery of an IP address from a server,
- BOOTP servers enabling a device to distribute IP addresses to the network stations.

*Schneider Electric uses standard BOOTP/DHCP protocols for its Faulty Device Replacement service (FDR).*

**FTP** "File Transfer Protocol" (RFCs 959, 2228, and 2640)

File Transfer Protocol (FTP) provides basic file sharing elements. Many systems use FTP protocol to exchange files between devices.

**TFTP** "Trivial File Transfer Protocol" (firmware updates of networking devices)

Trivial File Transfer Protocol (TFTP) is a network transfer protocol that facilitates connection to a device, and the downloading of code to this device. For example, it can be used to shove boot code onto a disk-less workstation, or connect and download firmware updates to networking devices

**Note:** *Transparent Ready devices implement FTP and TFTP for transferring certain data to or from devices, in particular when downloading firmware or user Web pages.*

**NTP** "Network Time Protocol" (RFC 1305)

NTP (Network Time Protocol) is used to synchronize the time of a client or server device from a time server. Depending on the network used, it provides the following time precisions based on the UTC:

- Several ms on a local area network (LAN).
- Several tens of ms on a wide area network (WAN).

**SMTP** "Simple Mail Transfer Protocol" (RFC 0821)

SMTP (Simple Mail Transfer Protocol) is an E-mail transmission service. It is used to send E-mail between a sender and a recipient via an SMTP E-mail server.

**SNMP** "Simple Network Management Protocol" (RFCs 1155, 1156 and 1157)

The Internet community developed standard SNMP for managing the different components of a network through a single system. The network management system can exchange data with SNMP agent devices. This function enables the manager to view the status of the network and devices, modify their configuration and feed back alarms in the event of a communication failure.

**Note:** *Transparent Ready devices are SNMP-compatible and can be integrated naturally in a network managed via SNMP.*

**COM/DCOM** "Distributed Component Object Model"

COM/DCOM (Distributed Component Object Model) or OLE (Object Linking and Embedding) is the name of the technology used in Windows components. This enables Windows applications to communicate transparently.

**Note:** *These technologies are used in the OFS Data server software.*

Modbus TCP/IP function codes	dec	hexa
<b>Bits access</b> Read of n input bits	02	02
Read of n output bits	01	01
Exceptional read status	07	07
Write 1 output bit	05	05
Write of n output bits	15	0F
Read of 1 input word	04	04
Read of n input words	03	03
Write 1 output word	06	06
Write of n output words	16	10
Read device ID	43/14	2B/0E
Access CANopen interface	43/13	2B/0D

Example of Modbus TCP/IP function codes supported for accessing data and diagnostics

**Functions (continued)**

**Modbus® communication standard**

Modbus®, the industrial communication standard since 1979, has been combined with Ethernet, which supports the Internet revolution, to make Modbus/TCP, a completely open Ethernet protocol. The development of a connection to Modbus/TCP requires no proprietary component or license purchase. This protocol may be easily combined with any device supporting a standard TCP/IP communication stack. Specifications can be obtained free of charge from the website: [www.modbus-ida.org](http://www.modbus-ida.org)

**Modbus/TCP, simple and open**

The Modbus application layer is very simple and universally recognized with its 9 millions installed nodes. Thousands of manufacturers are already implementing this protocol. Many have already developed a Modbus/TCP connection and many products are currently available. The simplicity of Modbus/TCP enables any small field team, such as an I/O module, to communicate over Ethernet without the need for a powerful micro-processor or a lot of internal memory.

**Modbus/TCP, high-performance**

Because of the simplicity of its protocol and the high speed of 100 Mbits/s Ethernet, Modbus/TCP delivers excellent performance. This means it is possible to use this type of network in real-time applications such as I/O Scanning.

**Modbus/TCP, one standard**

An identical application protocol is used for Modbus® serial link, Modbus Plus™ or Modbus/TCP. This therefore makes it possible to route messages from a network to another without changing protocol.

As Modbus is implemented above the TCP/IP layer, users can also benefit from the IP routing that helps to enable devices located anywhere in the world to communicate without having to worry about the distance between them. Schneider Electric offers an entire range of gateways for interconnecting a Modbus/TCP network to already existing Modbus Plus or Modbus serial link networks.

The IANA institute (Internet Assigned Numbers Authority) has assigned Schneider Electric port TCP 502, which is reserved for the Modbus protocol. So, it is a standard within the Internet community.

A study by ARC Advisory Group, the leading analyst firm covering automation and enterprise software, shows Modbus/TCP as the World's leading industrial Ethernet protocol, in terms of units shipped in 2004.

Modbus and Modbus/TCP are recognized by IEC 61158 international standard as a fieldbus. They are also "Chinese National Standard" managed by ITEI.

**CANopen interfacing Modbus/TCP**

CiA DSP 309-2 provides a standardized mapping of CANopen data for transport on Modbus/TCP networks. In the specification Modbus function code 43/13 is reserved for this purpose. The reservation of this function code is exclusively for CANopen

**Modbus/TCP characteristics**

- Maximum size of data:
- Read: 125 words or registers.
  - Write: 100 words or registers.

**Functions (continued)**

**I/O Scanning service**

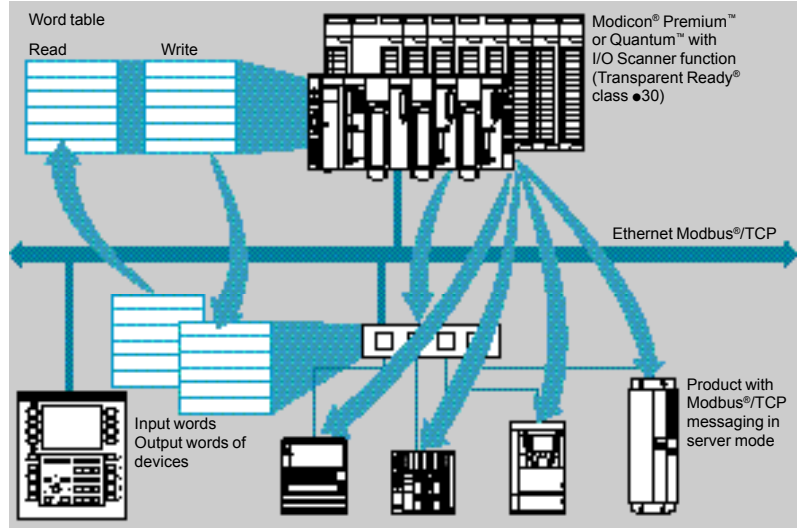

The I/O Scanning service can be used to manage the exchange of distributed I/Os on the Ethernet network after a simple configuration operation, with no need for special programming.

The I/Os are scanned transparently by means of read/write requests according to the Modbus® Master/Slave protocol on the TCP/IP profile.

This principle of scanning via a standard protocol enables communication with any device which supports a Modbus/TCP messaging in server mode.

This service can be used to define:

- An %MW word zone reserved for reading inputs
- An %MW word zone reserved for writing outputs
- Refresh periods independent of the PLC scan.

During operation, the module:

- Manages the TCP/IP connections with each of the distributed devices
- Scans the devices and copies the I/Os into the configured %MW word zone
- Feedback status words so that correct operation of the service can be monitored from the PLC application
- Applies the preconfigured fallback values in the event of a communication problem.

An offer of hardware and software products that help to enable the I/O Scanning protocol to be implemented on any type of product connected to the Ethernet network. Please consult: [www.modbus-ida.org](http://www.modbus-ida.org).

**Characteristics**

- Each station can exchange, with Unity™ software a maximum of:
  - 100 words for writing
  - 125 words for reading.
- Maximum size in the PLC managing the service:
  - 2 K words %MW (1) in inputs and 2 K words %MW (1) in outputs with manager PLC (64 stations max.)
  - 4 K words %MW (1) in inputs and 4 K words %MW (1) in outputs with manager PLC (128 stations max.).

**I/O Scanning service diagnostics**

I/O Scanning service diagnostics can be performed in 5 ways:

- By the application program from a data field specific to the PLC
- From the debugging screen in the programming software
- From the PLC system diagnostics function viewed with the Internet browser on a PC station
- From the ConneXview™ diagnostic software **TSC EAZ 01P SFE10**
- From the standard SNMP manager software.



(1) or 4x registers with Concept or ProWORX.



## Functions (continued)

### FDR (Faulty Device Replacement), replacement service for inoperative devices

The Faulty Device Replacement service uses the standard BOOTP/DHCP, file management and TFTP (*Trivial File Transfer Protocol*) technologies with the objective of simplifying Ethernet device maintenance.

It enables an inoperative device to be replaced by a new product while helping to ensure its detection, reconfiguration, and automatic restart by the system, without difficult manual intervention.

The principal steps are:

- 1 A device using the FDR service is inoperative.
- 2 Another similar device is taken from the maintenance pool, preconfigured with the "Device\_name" (or identifier) of the device that is out of service, then reinstalled on the network. The identifier is set by the position of the rotary switches, as for Advantys™ STB **a** or Advantys™ OTB distributed I/O. The "Device\_name" should be given with a keypad, for Altivar variable speed drives.
- 3 The FDR server detects the new addition, configures that device's IP address and transfers the configuration parameters to it.
- 4 The substituted device verifies if the parameters are indeed compatible with its own characteristics, then switches to operating mode.

The FDR server can be Modicon®:

- Premium™ Ethernet module **TSX™ ETY 4103/5103**,
- Premium™ processor with integrated Ethernet port **TSX™ P57 ●●●●M**,
- Quantum™ Ethernet module **140 NOE 771 01/771 11**,
- Quantum™ processor with integrated Ethernet port **140 CPU 651 50/60**,
- M340™ Ethernet module **BMX NOE 0100/0110**.

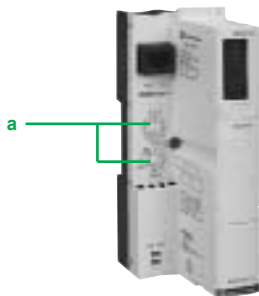

## Functions (continued)

### Global Data service

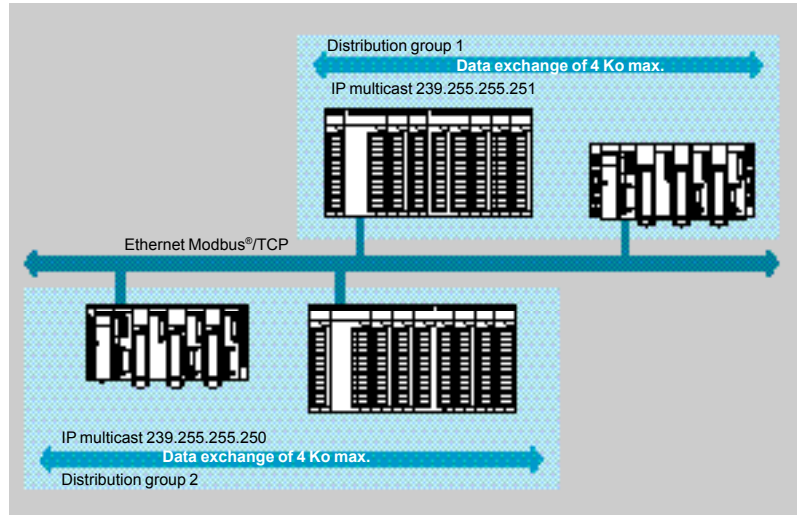

The Global Data service helps to ensure data exchanges in real-time between stations belonging to the same distribution group. It is used to synchronize remote applications, or share a common database among several distributed applications. The exchanges are based on a standard producer/consumer protocol that helps to ensure optimal performance while maintaining a minimum network load. This RTPS (Real-Time Publisher Subscriber) protocol is promoted by the Modbus-IDA organization, and has already been adopted as a standard by several manufacturers.

### Characteristics

A maximum of 64 stations can participate in Global Data within the same distribution group. Each station can:

- Publish one 1024-byte variable. The publication period can be configured from 1 to n periods of the Mast task of the processor.
- Subscribe to between 1 and 64 variables. Validity for each variable is controlled by Health Status Bits, linked to a refresh timeout configurable between 50 ms and 1 s. Access to a variable element is not possible. The total size of the subscribed variables reaches 4 K contiguous bytes.

In order to optimize Ethernet network performance further still, Global Data can be configured with the "multicast filtering" option, which together with switches in the ConneXium™ range (see pages 5/50 to 5/52), perform data broadcasting only on Ethernet ports, where there is a Global Data service subscriber station. If these switches are not used, Global Data is transmitted in "multicast" on all switch ports.

### Global Data service diagnostics

The diagnostics screens use a color code to show Global Data status:

- Configured/not configured/inoperative
- Published/subscribed.

Global Data service diagnostics can be performed in 5 ways:

- By the application program from a data field specific to the PLC
- From the debugging screen in the programming software
- From the PLC system diagnostics function viewed with the Internet browser on a PC station
- From the ConneXview™ diagnostic software **TSC EAZ 01P SFE10**
- From the standard SNMP manager software.



**Functions (continued)**

**NTP time synchronization service**

**Presentation**

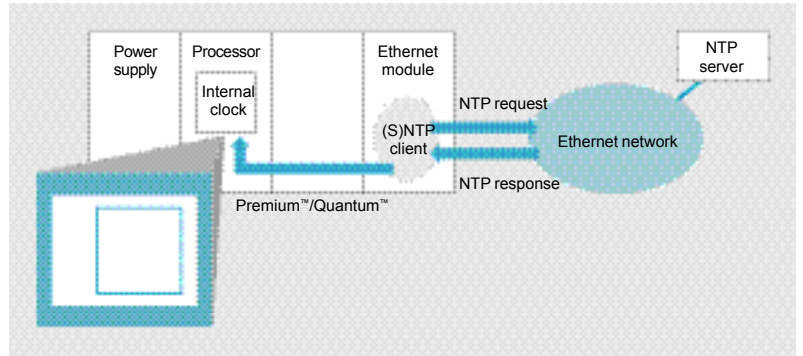

The time synchronization service is based on the NTP (*Network Time Protocol*) which is used to synchronize the time of a client or a server on Ethernet Modbus®/TCP from a server or another reference time source (radio, satellite, etc).

**Operation**

Some Ethernet communication modules for automation platforms:

- **140 NOE 771 11** with the Modicon® Quantum™ Unity™ ≥ V2.0,
  - **TSX™ ETY 5103** with Modicon® Premium™ Unity™ ≥ V2,
- have an NTP client component.

These modules can connect to an NTP server using a client request (unicast), in order to update their local time. The module clock is updated periodically (1 to 120 s) with a tolerance < 10 ms for processors, < 5 ms for high performance processors. If the NTP server cannot be reached, the Ethernet Modbus/TCP module switches to a standby NTP server.



Ethernet module associated with its Unity processor		Predicted typical time service precision		
Ethernet modules	Unity processors	Clock synchronization (1)	Event synchronization	Time stamping (2)
TSX™ ETY 5103	TSX™ P57 0244M TSX P57 1●4M TSX P57 2●4M TSX P57 3●4M	± 1 ms typical ± 10 ms max.	= Clock synchronization precision	= Clock synchronization precision
	TSX P57 4●4M TSX P57 5●4M TSX P57 664M	± 1 ms typical ± 5 ms max.	+ Fast task time	+ I/O time
140 NOE 771 11	140 CPU 311 10 140 CPU 434 12U 140 CPU 534 14U	± 1 ms typical ± 10 ms max.	+ I/O time	
	140 CPU 651 50 140 CPU 651 60 140 CPU 671 60	± 1 ms typical ± 5 ms max.		

(1) Time difference between field input and central NTP server.  
(2) Assuming input connected to the interrupt module.



The PLC processor clock is therefore itself updated with a precision of 5 ms for processors, 1 ms for high performance processors. A function block is available for reading this clock. In each PLC application, events or variables can be time-stamped.

The Ethernet module is configured via a Web page. The time zone can be configured. A time synchronization service (NTP) diagnostic Web page is also available.

Information on the time synchronization service (NTP) is also available in the Transparent Ready private MIB, which can be accessed via the SNMP network management service (see above).

**Functions (continued)**

**SMTP electronic mail notification service**

**Introduction**

This simple mail notification service is a programmed service that allows PLC applications to report by exception conditions monitored by the PLC. The automation controller can automatically and dynamically create E-mail to alert specified users with data, alarms and events - whether the recipients are local or remote.

*Note: This service is available on the latest version of Premium™/Quantum™ Ethernet modules & CPUs, when operating with Unity™ Pro software. A more comprehensive E-mail service, independent of the PLC application, is available on the FactoryCast™ HMI modules with the active Web server, see page 5/23*

**Usage**

A simple yet powerful mechanism is used. Predefined mail headers are linked together with the body of the E-mail which is created dynamically from the latest information in the automation application.

The user logic program can trigger the message based on a predefined event or condition. Using a function block, one of 3 predefined headers is selected and an E-mail message with variable information and text (up to a maximum of 240 bytes) is created and sent directly from the PLC.

Each of the three mail headers contains these common predefined items E-mail recipient list, sender name and subject. This information can be defined and updated by an authorized administrator using the configuration web pages.

**Message creation and delivery**

The PLC application selects the appropriate header. The system architect may define the mail headers to indicate differing importance levels. For example :

- Header 1 could be "URGENT problem reported by PLC 10",
- Header 2 might be "WARNING at substation 10",
- Header 3 could be "INFO message from water system".

Differing lists of recipients between the three headers help to ensure that the right information quickly flows to the right recipients. The application can then add pertinent information to the body of the E-mail message such as the specific device, process or location.

Completed E-mail is then sent to an electronic mail server for expeditious distribution to the interested parties. These recipients could be engineers, managers, process owners etc.

**Security**

Each E-mail message can be protected by an optional login and password that is authenticated by the SMTP mail server. If, for additional security, the site's mail installation has changed the TCP port number from the default of 25, the port number can be changed in the PLC E-mail configuration (via secured web page access).

**Configuration**

An authorized administrator can use a web page to easily configure the E-mail service. For each of the three mail headers, the sender; recipient list and subject message can be defined. The E- mail server connection information such as IP address and security information can also be set from the web page.

**Diagnostics**

Similar to other Ethernet services in Modicon® Premium™ and Quantum™ systems, the E-mail service has a Diagnostic Web page showing the current system status.

**Remote Monitoring**

These products provide diagnostic information for remote management applications following the SNMP network management standard. Information for the E-mail service is included in the Schneider Electric private MIB which is publicly available.

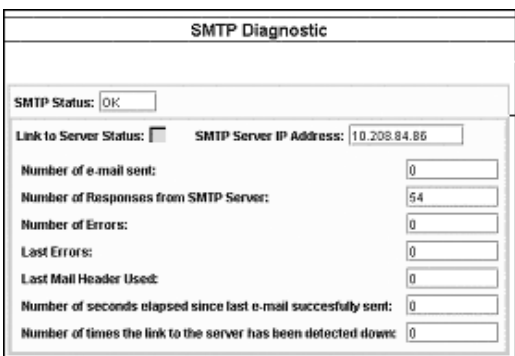

## Functions (continued)

### SNMP service protocol

The SNMP (Simple Network Management Protocol) protocol is used, from a network management station, to monitor and control all Ethernet architecture components and to help ensure rapid diagnostics if a problem occurs.

It is used to:

- Query devices such as computer stations, routers, switches, bridges or terminal devices (DTE) in order to view their status
- Obtain statistics for the network on which the devices are connected.

This management software respects the traditional Client/Server model. However, in order to avoid confusion with other communication protocols using this terminology, we prefer to use these definitions:

- ConneXview™ network diagnostic software **TSC EAZ 01P SFE10**
- Network manager for the Client application running on the computer station
- SNMP agent for the server application that runs on the device.

Transparent Ready® can be managed by any SNMP network manager, including HP Openview® or IBM Netview®.

Standard SNMP (Simple Network Management Protocol) is used to access configuration and management objects included in the MIB (Management Information Base) for the devices. These MIBs must comply with certain standards in order to be accessed by available management services. However, depending on the device complexity, manufacturers can add certain objects to the private databases.

The Transparent Ready private MIB includes management objects specific to the Schneider Electric offer. These objects simplify installation, implementation, and maintenance for Transparent Ready products in an open environment using standard network management tools.

The Transparent Ready products support 2 SNMP network management levels:

- Standard MIB II, a first level of network management, can be accessed via this interface. It lets the manager identify the devices forming the architecture and retrieve general information on the configuration and operation of the Ethernet TCP/IP interfaces
- MIB Transparent Ready interface; management of the Transparent Ready devices is improved via this interface. This MIB includes a set of data that enables the network management system to supervise the Transparent Ready services. The Transparent Ready private MIB can be downloaded from the Web server from any Ethernet Transparent Ready module in a PLC.

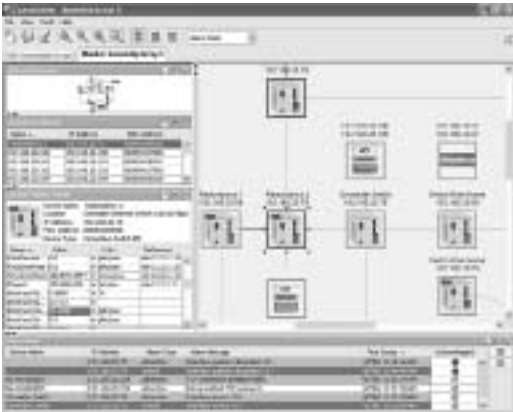

Automatic recognition of IP devices via the ConneXview™ diagnostic software for Ethernet industrial networks

# Modicon® Premium™ automation platform

Transparent Ready®  
Ethernet Modbus®/TCP communication service

## TCP Open™ optional service

### Presentation

TSX™ ETY 110 WS/5103 Premium™ platform Ethernet modules support a number of communication protocols based on the TCP/IP standard. Among these, the Modbus® protocol has public specifications and its simplicity recommends it for the needs of communication with third-party devices.

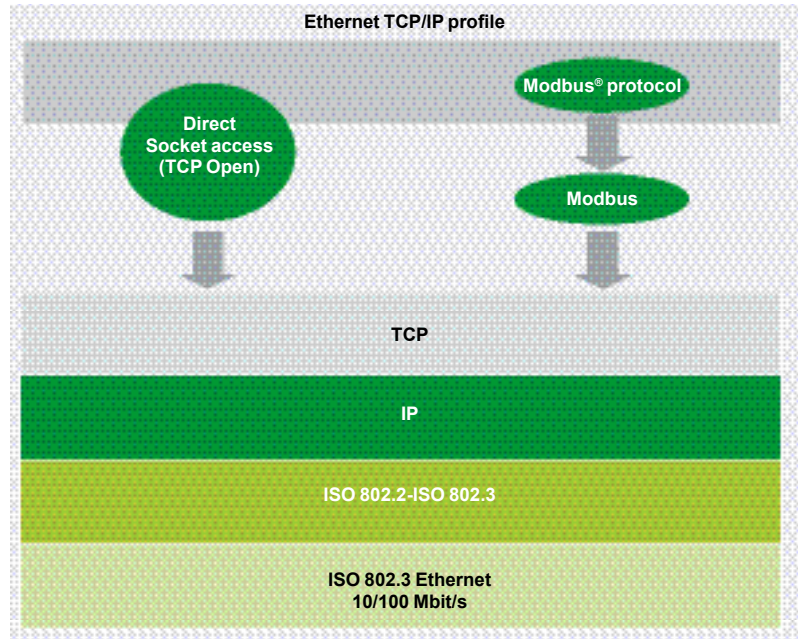

However, for certain applications, it may prove necessary to use other protocols. This is the case when, for example, users wish to integrate Modicon® Premium™ platforms into existing architectures which use a particular communication protocol, possibly a proprietary one.

To meet these needs for open access, 2 interface levels are included in the Schneider Electric offer:

- A library of basic functions, which can be used in C language, helps to enable direct access to the socket interface on TCP. The user can create his own communication functions using SDKC development software and take advantage of the ease of use this program offers in terms of development and debugging. Once generated, these function blocks are used in the application like any standard PL7™ or Unity™ Pro programming software function block
- A library of basic function blocks known as EFs can be used directly in the application programs with the PL7 or Unity Pro languages. These are the same as functions developed in C language seen earlier, but are designed for use by non-computer specialists. These EF function blocks are not modifiable.

### Functions

Operating in TCP connection client/server mode, the basic functions on the Berkeley socket interface enable:

- Management of 16 connections on the Open profile out of a maximum of 32
- Creation of sockets and their attachment to any TCP port
- Switching of these sockets to "listen for a connection request from a remote client" mode
- Opening of a connection
- Transmission and reception of data on these connections (8 bytes max.)
- Closing this connection.

## TCP Open™ optional service (continued)

### Description

The TCP Open™ offer consists of a CD-ROM containing the TCP/IP function libraries. Open access on TCP is only possible via **TSX™ ETY 110WS (1)** and **TSX ETY 5103 Ethernet modules**. With open access on TCP, the basic functions of these modules can be used.

The TCP/IP **TLX CD TCP 50M** function library is comprised of:

- The SDKC program enhancement library that provides access to the module TCP/IP socket functions
- The user's manual in English (electronic copy only)
- EF elementary communication function blocks (Socket/Bind/Listen/Accept/Shutdown/Close/Send/Receive/Select/Set\_Socket Option/Connect) for installation using PL7™ software (version ≥ V3.3)
- Higher level EF function blocks, provided by way of example, which can perform more advanced functions such as the complete sequence for establishing or closing a connection, or sending or receiving data. The source files for these EF blocks are also supplied
- An example of a PL7 application communicating with a TELNET application on a PC.

If customized function blocks are needed both:

- the SDKC program for C language:
  - **UNY SPU ZU CD 20E** (with Unity™ Pro software)
  - or **TLX L SDKC PL741M** (with PL7 software)
- and the library of function blocks TCP Open **TLX CD TCP50M** should be installed on the development station.

### Setup precautions

The development of C language functions requires compliance with certain setup precautions:

- To set up these services, the user should be familiar with the TCP/IP profile
- In addition, since the SDKC program enables access to all the PLC internal resources, the necessary precautions should be taken when developing EF communication blocks to avoid endangering the PL7 application, especially on the commonly fragile operating modes such as cold/warm restarts, response to a fault, etc
- The user should also take care to maintain the requests from the different communication profiles at a level compatible with the performance required by the application
- Finally, it is the responsibility of the client application software (PL7, Unity Pro or C program) to manage the operating modes for communications that may be specific to the application. For example, how should the application behave if a remote device does not respond, or if there is a break in the connection?

For these different reasons, we recommend that you consult your Schneider Electric Regional Sales Office to help ensure that your TCP protocol open access project is feasible.

(1) Open access on TCP requires **TSX ETY 110 WS modules**, version ≥ PV 03 and SV 2.9. In addition, it should be integrated on a configuration with a **TSX P57 ●●3/●●4 processor** (or **TSX P57 ●●2** version > V3.3).

### Selecting the communication architecture

When choosing an architecture, it is advisable to take account of the required performance as early as possible. To do this, the developer must:

**1** Know exactly what he needs:

- quantity and type of devices to be connected to one another
- volume and type of exchanges
- expected response times
- environment

**2** Compare his needs with the characteristics of the available offers, being aware that the actual performance level between any 2 points in an architecture is dependent on the weakest link in the chain, which may:

- depend on the hardware
- but also depends on the applications (size, architecture, operating system, machine power rating, etc) which are often only vaguely defined at this stage of the project.

**3** Determine which is the most suitable architecture.

The purpose of the next few pages is to provide the main information and instructions needed to answer the second point. Given that the performance of an Ethernet architecture is linked to several parameters, these pages do not supply all the information needed to calculate the network performance. Their aim is to focus on the following main aspects:

■ **Instructions for calculating the network load** so as to design an Ethernet network that meets the demands of the applications.

■ **Application response time** to be obtained depending on the configuration used, see page 9/39 of this catalog.

■ **Processing capacities of Modicon® M340™, Modicon® Premium™ and Modicon® Quantum™ platforms** used to select the processor and define the number of Ethernet connections required on the PLC depending on the application. Please see pages 5/42 and 5/43.

### Calculating the network load

#### Introduction

When calculating the load on an Ethernet network, the communication services of the peripheral devices connected to the network need to be calculated. Because of the outstanding performance of the Ethernet network, the load is often less than the limits of the Ethernet network and does not greatly affect the application response time. This phenomenon is explained by the high speed of the Ethernet network: the network transaction time is 10% less than the application response time. In order to help ensure a low network load and avoid large theoretical calculations, it is highly advisable to separate the collision domain so as to limit the network load, using only the switched network (tree, star or daisy-chain topology).



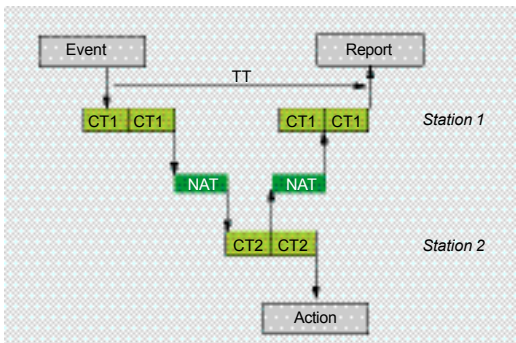

### Application response time

#### Modbus® (or Uni-TE™) messaging service response time

Exchanges between the PLC processor and the Ethernet module are synchronous with the PLC scan time (CT), just like the I/O exchanges. On occurrence of the event (an input set to state 1 for example), a message can only be sent after this event has been recorded. The start of the next cycle, and execution of the PLC program (Modicon® M340™, Modicon® Premium™ or Modicon® Quantum™), are on average around 1.5 cycle times after occurrence of the event.

The network access time (NAT) appearing in the table below in ms, adds together the module transit time and the waiting time before the message can be sent on the network.

Processing Modbus®/TCP message requests	Modicon® M340™		Modicon® Premium™		Modicon® Quantum™	
		BMX NOE 0100 BMX NOE 0110	BMX P34 2020 BMX P34 2030	TSX™ ETY 210 TSX ETY 110WS	TSX ETY 4103/5103 TSX™ WMY 100 TSX™ P57 10...57 60	140 NOE 771 01/111 140 CPU 113/311 ●● 140 CPU 434/534 1●
Network access time NAT	< 10 ms	< 10 ms	< 25 ms	< 10 ms	< 10 ms	< 10 ms

The transaction time TT integrates the delay between sending a message from a client station 1, its reception by the server station 2, processing the request, sending the response and it being taken into account by the station 1 (updating an output for example).

As shown in the above block diagram:

- The transaction time TT should be between:
 
$$2 \times CT1 + 2 \times NAT < TT < 4 \times CT1 + CT2 + 2 \times NAT$$
- The average duration  $TT_{av}$  is equivalent to:
 
$$TT_{av} = 3 \times CT1 + 0.5 \times CT2 + 2 \times NAT$$

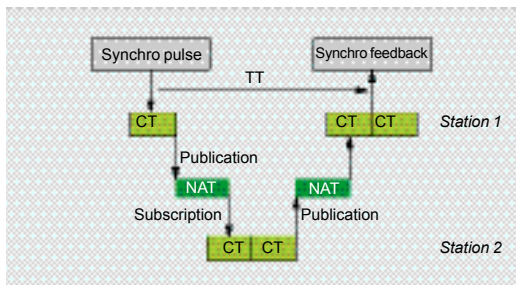

#### Global Data service response time

The transaction time TT integrates the delay between publication of a Global Data service by station 1, its reception and its processing by the remote station 2 and it being resent to the initial station 1:

For an exchanged variable:

- If  $CT < 5$  ms, transaction time:  $TT = 5 \text{ to } 6 \times CT$
- If  $CT \geq 10$  ms, transaction time:  $TT = 3 \times CT$

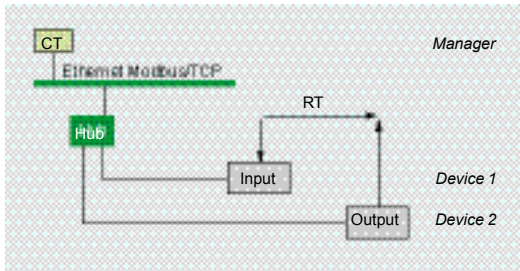

### Application response time (continued)

#### I/O Scanning service response time

The response time RT includes the time between taking a remote input into account and updating the state of a remote output. It includes the processing time in the PLC.

This response time RT consists of the following parameters:

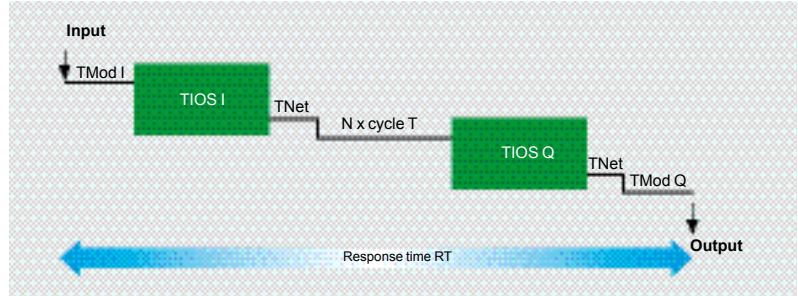

- TMod In and TMod Out: Response time of the read/written device, excluding the electrical transit time at the input/output (TMod depends on the device, usually between 1 and 8 ms)
- TIOS In and TIOS Out: Time between 2 read/write operations on the same device (0.3 ms x number of scanned devices), at least equivalent to the configured scan time
- As TIOS is executed in parallel with the PLC scan, it can be hidden with respect to the response time RT).
- Cycle T: PLC scan time.
- TNet : propagation time on the network (depends on the application, usually TNet = 0.05 ms at 10 Mbit/s and 0.005 ms at 100 Mbit/s).

The response time RT can be estimated with the following 3 formulas:

- $RT_{min}$ : minimum response time with TIOS hidden and 1 PLC scan:  

$$RT_{min} = (TMod In + 0) \times TIOS In + (Tnet + N) \times cycle T + (0 \times TIOS Out) + Tnet + TMod Out$$
- $RT_{typ}$ : typical response time with 0.5 TIOS hidden:  

$$RT_{typ} = (TMod In + 0,5) \times TIOS In + (Tnet + N) \times Cycle T + (0,5 \times TIOS Out) + Tnet + TMod Out$$
- $RT_{max}$ : maximum response time with TIOS not hidden:  

$$RT_{max} = TMod In + TIOS In + (Tnet + N) \times Cycle T + TIOS Out + Tnet + TMod Out$$

# Modicon® Premium™ automation platform

## Ethernet Modbus®/TCP network

### Application response time (continued)

#### I/O Scanning service response time (continued)

Below are the TMod In and TMod Out response times:

Type of distributed I/O	Response time	Values		
		Min.	Typical	Max.
Momentum 170 ENT 110 02	TMod In	1 ms	1 ms	1 ms
	TMod Out	5 ms	5 ms	5 ms
Momentum 170 ENT 110 01	TMod In	4 ms	6 ms	8 ms
	TMod Out	4 ms	6 ms	8 ms
Modicon STB STB NIP 2212	TMod In	2 ms	3 ms	4 ms
	TMod Out	2 ms	3 ms	4 ms

Below are the TIOS In/TIOS Out times measured between 2 scan cycles (Ethernet network with switches)

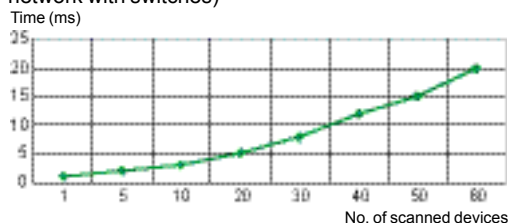

Below is the number of processor cycles N:

Type of Ethernet module or processor	No. of processor cycles N		
	Min.	Typical	Max.
Modicon® M340™ platform with Ethernet modules: <b>BMX NOE 0100</b> and <b>BMX NOE 0110</b>	2	2.5	3
Modicon® Premium™ platform with Ethernet modules: <b>TSX ETY 4103</b> and <b>TSX ETY 5103</b>			
Modicon® Quantum™ platform with Ethernet modules: <b>140 NOE 771 01</b> and <b>140 NOE 771 11</b>			
Modicon® M340™ processors: <b>BMX P34 2020</b> and <b>BMX P34 2030</b>			
Modicon® Premium™ processors: <b>TSX P57 26/3634M</b> , <b>TSX P57 26/2823M</b> and <b>TSX P57 36/4823AM</b>			
Modicon® Premium™ processors: <b>TSX P57 4634M/5634M/6634M</b>	1	1	2
Modicon® Quantum™ processors: <b>140 CPU 651 50</b> and <b>140 CPU 651 60</b>			



# Modicon® Premium™ automation platform

## Ethernet Modbus®/TCP network

### Processing capacities of Modicon® platforms

#### Processing capacity

Use the table below to compare for each station, the total number of messages received on the Modbus® (or Uni-TE™) messaging service if used (value R1, R2 or Ri) with the station processor capacity.

Processing Modbus requests for each PLC scan

Modicon® Premium™ and M340™ platforms		Messages received
Total messages received by the PLC from all the communication modules (1)	TSX™ 57 10	4 messages/cycle
	BMX P34 20/TSX 57 20	8 messages/cycle
	TSX 57 30	12 messages/cycle
	TSX 57 40	16 messages/cycle
	TSX 57 50/60 (2)	16/20 messages/cycle

Modicon® Quantum™ platform	Limitations of the integrated port		Limitations of the communication modules		Ethernet modules per PLC
	Communication requests	Additional read/write 4x registers	Communication requests	Additional read/write 4x registers	
140 CPU 113 (3)	–	–	1 message/cycle	4 messages/cycle	max. 2
140 CPU 311	–	–	1 message/cycle	4 messages/cycle	max. 2
140 CPU 434/534	–	–	4 messages/cycle	8 messages/cycle	max. 6
140 CPU 651	16 messages/cycle	16 messages/cycle	4 messages/cycle	8 messages/cycle	max. 6

messages/cycle: number of messages received per cycle from the PLC master task (typical cycle of 50 to 100 ms)

Example:

Quantum 140 CPU 434 12● processor with 4 Ethernet 140 NOE 771 ●1 modules:

- 20 messages/cycle for communication request, and
- 32 messages/cycle for the read/write 4x registers

#### Ethernet transaction processing capacity

Compare, for each station, the total number of messages received  $\sum [values Ri, Rj]$  and the total number of messages sent  $\sum [values Ei, Ej]$  (for example, for station N) with the Ethernet transaction processing capacity indicated below.

Use the elements below for the Ethernet connection per PLC, rather than the number of transactions required by the application.

Ethernet transaction processing capacity	Modicon® M340™		Modicon® Premium™			Modicon® Quantum™	
	BMX NOE 0100 BMX NOE 0110	BMX P34 2020 BMX P34 2030	TSX™ ETY 210 TSX ETY 110WS	TSX ETY 4103/5103 TSX™ WMY 100 TSX P57 10/20/30/40	TSX™ P57 50 TSX P57 60	140 NOE 771 01 140 NOE 771 11 140 NWM 100 00	140 CPU 65 150 140 CPU 65 160 140 CPU 67 160
Modbus® messaging	500 transactions/s	500 transactions/s	60 transactions/s	450 transactions/s	500 transactions/s	350 transactions/s	350 transactions/s
I/O Scanning service	2,000 transactions/s	Server mode (4)	Service not available	2,000 transactions/s (5)	2,000 transactions/s	2,000 transactions/s (5)	2,000 transactions/s
Subscription of Global Data	800	Service not available	Service not available	800	800	800	800

(1) A temporary overload, due for example to an adjustment terminal or the temporary connection of an Internet browser, on which a few PLC scans are permitted.

(2) Only with Unity Pro software.

(3) Only with Concept/ProWORX software.

(4) BMX P34 20●0 processors having the Modbus/TCP messaging in server mode can be scanned by a product having the I/O Scanning service.

(5) Modules TSX WMY 100 and 140 NWM 100 00 : not featuring I/O Scanning and Global Data services.

# Modicon® Premium™ automation platform

## Ethernet Modbus®/TCP network

### Processing capacities of Modicon® platforms (continued)

#### Maximum number of simultaneous Modbus®/TCP connections

The maximum number of simultaneous Modbus/TCP connections depends on the platform as well as the type of connection to the Ethernet network:

- The 10/100BASE-TX port in network modules.
- The 10/100BASE-TX port integrated in processors.

Number of simultaneous Modbus®/TCP connections	Modicon® M340™		Modicon® Premium™			Modicon® Quantum™	
	BMX NOE 0100 BMX NOE 0110	BMX P34 2020 BMX P34 2030	TSX™ ETY 210 TSX ETY 110WS	TSX ETY 4103/5103 TSX™ WMY 100 TSX™ P57 10...57 60	140 NOE 771 01/11 140 CPU 113/311 ●● 140 CPU 434/534 14B	140 CPU 65 150 140 CPU 65 160	
Client	16	16	32	16 (1)	16 (1)	16 (1)	
Server	16	16		64 (1)	64 (1)	64 (1)	

(1) With 64 simultaneous Modbus/TCP connections maximum (clients and servers).

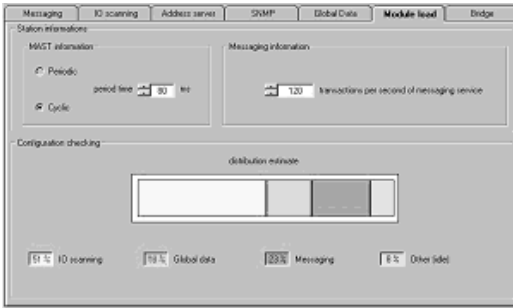

#### Managing the passband of Ethernet Modbus®/TCP modules

The passband management service indicates the load level of the Ethernet network module. This allows the user to monitor any drift and anticipate any problems. The Ethernet module load is indicated in 3 ways:

- Expected load in the Unity™ Pro/PL7™ configuration screen.
- Actual load in the Unity Pro/PL7 diagnostics/debug screen, as well as in the diagnostics pages via the Web. It is displayed in the form of a bar chart animated in real time.
- In the SNMP interface for access by the SNMP network manager.



The passband is indicated as a percentage for each of the following services:

- Modbus (and Uni-TE™) messaging
- I/O Scanning
- Global Data
- Other



Ethernet port integrated in processor, example with the BMX P34 2020/2030 Modicon M340

or

Ethernet dedicated module, example with the BMX NOE 0100/0110 Modicon M340

#### Ethernet solutions with the Modicon platforms

The Modicon PLC has 2 types of connection to the Ethernet network:

- The 10/100BASE-TX port integrated in processors, which also process the application, exchanges with other modules supported by the rack and other communication ports (CANopen bus, Modbus serial link, ...).
- The 10/100BASE-TX port in the dedicated module on which, unlike the processor, the resources are allocated to Ethernet Modbus/TCP communication.

These fundamentally different hardware characteristics result in equally different capacities in terms of services and performance:

- The integrated port is a low-cost way of satisfying applications that are not too demanding in terms of communication ( $\leq 500$  useful messages/s) in environments little affected by interference.
- Where there are a large number of exchanges, or networks are heavily polluted, use of a dedicated module is unavoidable.

# Modicon® Premium™ automation platform

## Processors with integrated Ethernet port

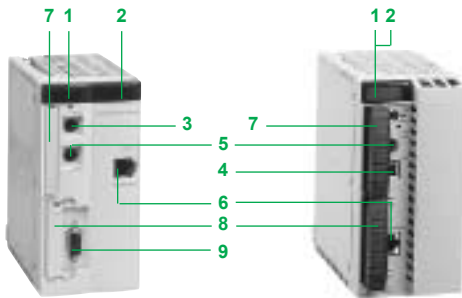

### Description

- TSX™ P57 1634M/26●●/2823/36●●/4634/4823/5634/6634M** double format processors (1) with built-in Ethernet port include the following on the front panel:
- 1 A display block with 5 LEDs relating to the processor.
  - 2 A display block relating to the built-in Ethernet port.
  - 3 An 8-way female mini-DIN connector marked TER for connecting a programming or adjustment terminal.
  - 4 A USB connector marked TER for connecting a programming or adjustment terminal.
  - 5 An 8-way female mini-DIN connector marked AUX for connecting an RS 485 peripheral device.
  - 6 A standard (RJ45) connector for 10BASE-T/100BASE-TX interface.
  - 7 A slot for a PCMCIA memory extension card.
  - 8 A slot for a PCMCIA communication or data storage memory extension card.
  - 9 A 9-way SUB-D connector (on **TSX P57 2823/4823M** models) for Fipio bus manager link.

### Characteristics

Type of module	Unity™ Pro software PL7™ Pro software	TSX™ P57 1634M	TSX P57 2634M TSX P57 2●23M	TSX P57 3634M TSX P57 3622AM	TSX P57 4634M TSX P57 4823AM	TSX P57 5634M TSX P57 6634M	
<b>Transparent Class</b>		B30					
<b>Ready services</b>	Standard Web server	"Rack Viewer" access to the product description and status and to the PLC diagnostics "Data editor" access to the configuration functions and PLC variables					
	Standard Ethernet communication service	Modbus®/TCP messaging (read/write data words)					
	Ethernet advanced communication services	I/O Scanning				Yes (between 64 stations)	Yes (128 stations)
		Global Data					Yes
		FDR server					Automatic assignment of IP address and network parameters
		SMTP E-mail notification					Yes, via Unity Pro function blocks
		SNMP network administrator					Yes
		Pass band management					Yes
<b>Structure</b>	Physical interface	10BASE-T/100BASE-TX (RJ45)					
	Data rate	10/100 Mbps with automatic recognition					
	Medium	Twisted pair					
<b>Premium processor</b>	No. of discrete I/O	512	1024		2048		
	No. of analog I/O	24	80	128	256	512	
	No. of application-specific channels	8	24	32	64		
	Max. no. of network connections (including integrated link)	1		3	4		
	Other communication service	Uni-TE™/TCP	Client/server requests: 128 bytes in synchronous mode and 1 Kb in asynchronous mode				
		X-Way	Yes				
	Operating temperature	0...+60°C					
	Relative humidity	10...95% non condensing during operation					
	Degree of protection	IP 20					
	Power supply	Via the power supply of the rack supporting the processor					
Conformity to standards	IEC/EN 61131-2, UL 508, CSA 1010-1, FM Class 1 Division 2 Group A/B/C/D, CE						
LED indicators	Ethernet network status (RUN), transmission/reception activity (TX/RX) Collision detection (COL), Ethernet link diagnostics (STS), Ethernet port detected fault (ERR) 5 LEDs specific to the operation of the processor (RUN, ERR, I/O, TER and FIP)						

### References



TSX P57 4634/5634/6634M

TSX P57 26/28/36/48●●M

Description	Discrete I/O Analog I/O App-sp. chann.	Reference		Weight kg
		Unity™ software	PL7™ software	
Processors with integrated Ethernet link	512 / 24 / 8	<b>TSX P57 1634M</b>	–	–
	1024 / 80 / 24	<b>TSX P57 2634M</b>	<b>TSX P57 2623M</b>	–
	–	–	<b>TSX P57 2823M</b>	(2)
Class B30	1024 / 128 / 32	<b>TSX P57 3634M</b>	<b>TSX P57 3623AM</b>	–
	2048 / 256 / 64	<b>TSX P57 4634M</b>	<b>TSX P57 4823AM</b>	(2)
	2048 / 512 / 64	<b>TSX P57 5634M</b>	–	–
	2048 / 512 / 64	<b>TSX P57 6634M</b>	–	–

(1) Except **TSX P57 1634M** processor, single format.  
 (2) Also has an integrated Fipio bus manager link.

# Modicon® Premium™ automation platform

## Ethernet network modules

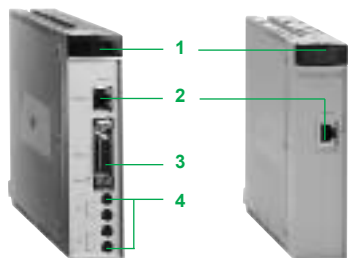

### Presentation

**TSX™ ETY ●●●** modules are single format modules installed in a rack slot on Modicon® Premium™ PLC stations. A configuration can take from 1 to 4 network modules, depending on the type of processor.

**TSX ETY 110 WS/4103/5103** Ethernet modules route X-Way and Uni-TE™ messages transparently from a Modbus®/TCP network to an X-Way™ network and vice versa.

### Description

The front panel of **TSX ETY ●●●** modules is comprised of:

- 1 A display block indicating the state of the module.
- 2 A standard connector for 100BASE-TX and/or /100BASE-T interface (RJ45) depending on the model.
- 3 A standard connector for 10BASE5 interface (AUI).
- 4 Four thumbwheels for defining the station number and network number.

### Characteristics

Type of module		TSX™ ETY 110 WS FactoryCast™	TSX ETY 4103	TSX ETY 5103 FactoryCast	TSX™ WMY 100 FactoryCast HMI	
<b>Transparent Ready® services</b>	Class	C10	B30	C30	D10	
	Standard Web server	"Rack Viewer" access to the product description and status and to the PLC diagnostics "Data editor" access to the configuration functions and variables				
	FactoryCast™ configurable Web server	Yes	–	Yes	–	
	User Web pages (available size)	Yes (1.4 Mb)	–	Yes (8 Mb)	–	
	FactoryCast HMI active Web server	–	–	–	Yes (1)	
	Standard Ethernet communication services	Modbus/TCP messaging (read/write data words)				
	Ethernet advanced communication services	I/O Scanning	–	Yes (between 64 stations)	–	–
		Global Data	–	–	Yes	–
		FDR server	–	Automatic assignment of IP address and network parameters		–
		NTP time synchronization	–	–	Yes	–
SMTP E-mail notification		–	Yes, via Unity™ Pro function blocks		Yes, active Web server	
SNMP network administrator		SNMP agent				
SOAP XML Web service		–	–	Server	Client/server	
TCP Open™		Option	–	Option	–	
Pass band management	–	Yes	–	–		
<b>Structure</b>	Physical interface	10BASE-T (RJ45) 10BASE5 (AUI)	10BASE-T/100BASE-TX (RJ45)			
	Data rate	10 Mbit/s	10/100 Mbit/s with automatic recognition			
	Medium	Twisted pair/AUI cable	Twisted pair			
<b>Network module</b>	Operating temperature	0...+ 60°C				
	Relative humidity	10...95% non condensing during operation				
	Degree of protection	IP 20				
	Power supply	Via the power supply of the rack supporting the module				
	Other communication service	Uni-TE™/TCP	Client/server requests: 128 bytes in synchronous mode and 1 K bytes in asynchronous mode			–
		Ethway™/X-Way™	Uni-TE, common words	–		
	Conformity to standards	IEC/EN 61131-2, UL 508, CSA 1010-1, FM Class 1 Division 2 Group A/B/C/D, CE				
LED indicators	Ethernet network status (RUN), transmission/reception activity (TX/RX) Collision detection (COL), Ethernet port detected fault (ERR)					

### References



TSX ETY 110WS



TSX ETY ●103/WMY 100

Description	Data rate	Transparent Ready® class	Reference	Weight kg
<b>Ethernet Modbus®/TCP modules</b>	10 Mbit/s	C10	<b>TSX ETY 110 WS</b>	0.370
	10/100 Mbit/s	B30	<b>TSX ETY 4103</b>	0.340
		C30	<b>TSX ETY 5103</b>	0.340
			D10	<b>TSX WMY 100</b>
<b>Web Designer software</b>	FactoryCast server configuration		Supplied with TSX ETY 110WS/5103 and TSX WMY 100	
<b>TCP Open™ software</b>	TCP Open function block library		<b>TLX CD TCP50M</b>	–
	SDKC, C language	Unity™ applications	<b>UNY SPU ZFU CD20E</b>	–
		PL7™ applications	<b>TLX LSDKC PL741M</b>	–

(1) Database management, arithmetic and logic calculations, automatic E-mail transmission on process event, connection to relational databases.

**EtherNet/IP™**  
conformance tested  
Certification logo Mark



### Presentation

**TSX™ ETC 100** EtherNet/IP™ network module is a single format module that is installed in a rack slot on Modicon® Premium™ PLC stations.

A configuration can take from 1 to 4 network modules, depending on the type of processor or slot-PLC.

### EtherNet/IP protocol

EtherNet/IP is the industrial Ethernet network protocol based on (*Common Industrial Protocol*)

CIP and EtherNet/IP are protocols owned and managed by the ODVA™, an independent standards organization composed of members from the world's leading automation companies.

Schneider Electric is a principal member of the ODVA organization.

Schneider Electric's increased support of ODVA gives existing Modbus®/TCP users a clear path to CIP network architectures while protecting their automation investments. Users will benefit through significantly increased interoperability between the largest installed base of industrial Ethernet networks - EtherNet/IP and Modbus/TCP - as well as between automation products from a growing number of vendors.

Combined, these benefits will reduce cost, time and risk for users deploying and maintaining their network architectures.

5

### Description

The front panel of **TSX ETC 100** module features:

- 1 A display block which indicates the module status and the transmission status of the network
- 2 A unique MAC address of the module.
- 3 Two additional status LEDs "MOD STATUS" and "NET STATUS"
- 4 A standard RJ 45 connector for 10BASE-T/100BASE-TX interface.

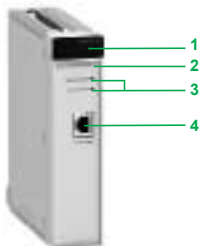



Characteristics		TSX™ ETC 100
<b>Type of module</b>		TSX™ ETC 100
<b>Network protocols</b>	EtherNet/IP™	Yes
	Modbus®/TCP	–
<b>Services Ethernet</b>	EtherNet/IP services	CIP Implicit Messaging (I/O communication) CIP Explicit Messaging (client messaging)
	I/O Scanning	–
	SNMP	Yes
	BootP/Serveur DHCP	Yes
	Auto MDI/MDX	Yes (avoids the use of crossover cable)
<b>Structure</b>	Physical interface	10BASE-T/100BASE-TX (RJ45)
	Binary rate	10/100 Mbit/s with automatic recognition
	Medium	Twisted pair
<b>Network module</b>	Operating temperature	0...+60 °C
	Relative humidity	10...95 % no condensing during operation at 60 °C
	Degree of protection	IP 20
	Power supply	Via the power supply of the rack supporting the module
	Conformity to standards	UL 508, cUL, CSA 22.2 N° 142, C-Tick, CE, ODVA (EtherNet/IP)
	LED indicators	Backplane communication status (RUN), transmission/reception activity (TX/RX), collision detection (COL), detected error condition (ERR), configuration status (STS) Status of the module (Mod Status) Network communication status (Net Status)

### Reference



TSX ETC 100

Description	No. of module per PLC	Data rate	Reference	Weight kg
<b>EtherNet/IP network module</b>	1...4 modules depending on type of Unity processor See pages 1/12 (1)	10/100 Mbit/s	<b>TSX ETC 100</b>	0,340

(1) The Modicon Premium configuration can be supported the 2 types of network modules : EtherNet/IP TSX ETC 100 and Ethernet Modbus/TCP TSX ETY ●●●●.

## Presentation

Schneider Electric offers copper and fiber-optic Ethernet cables for wiring your IP 20 and IP 67 devices.

## Examples

### Combined IP 20 and IP 67 wiring (copper)

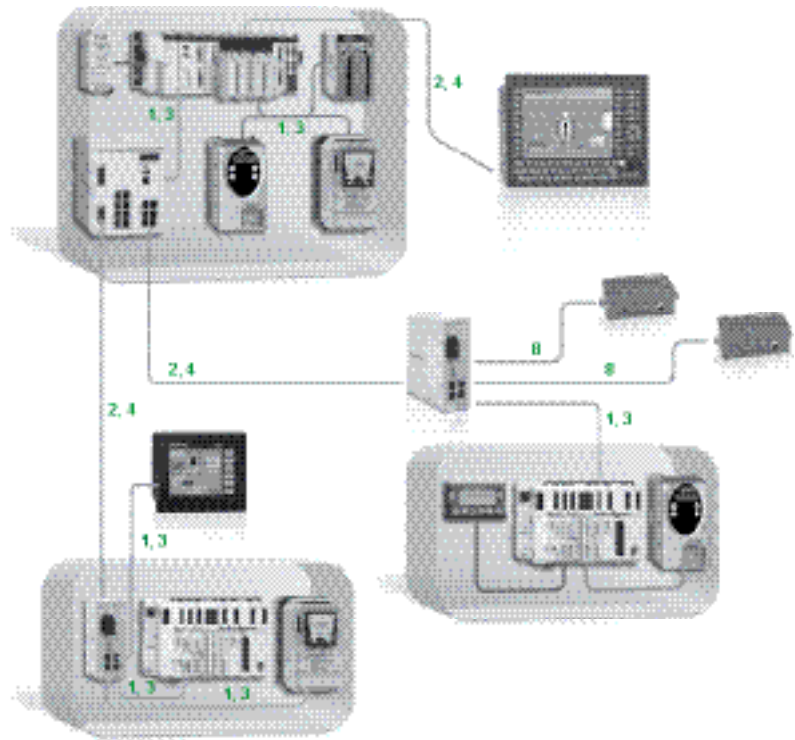

For key:  
1, 3: Straight copper cordsets,  
2, 4: Crossed copper cordsets,  
8: Cables with IP 67 connector,  
see pages 5/50 and 5/51.

**Examples (continued)**  
**Combined Copper and Fiber wiring**

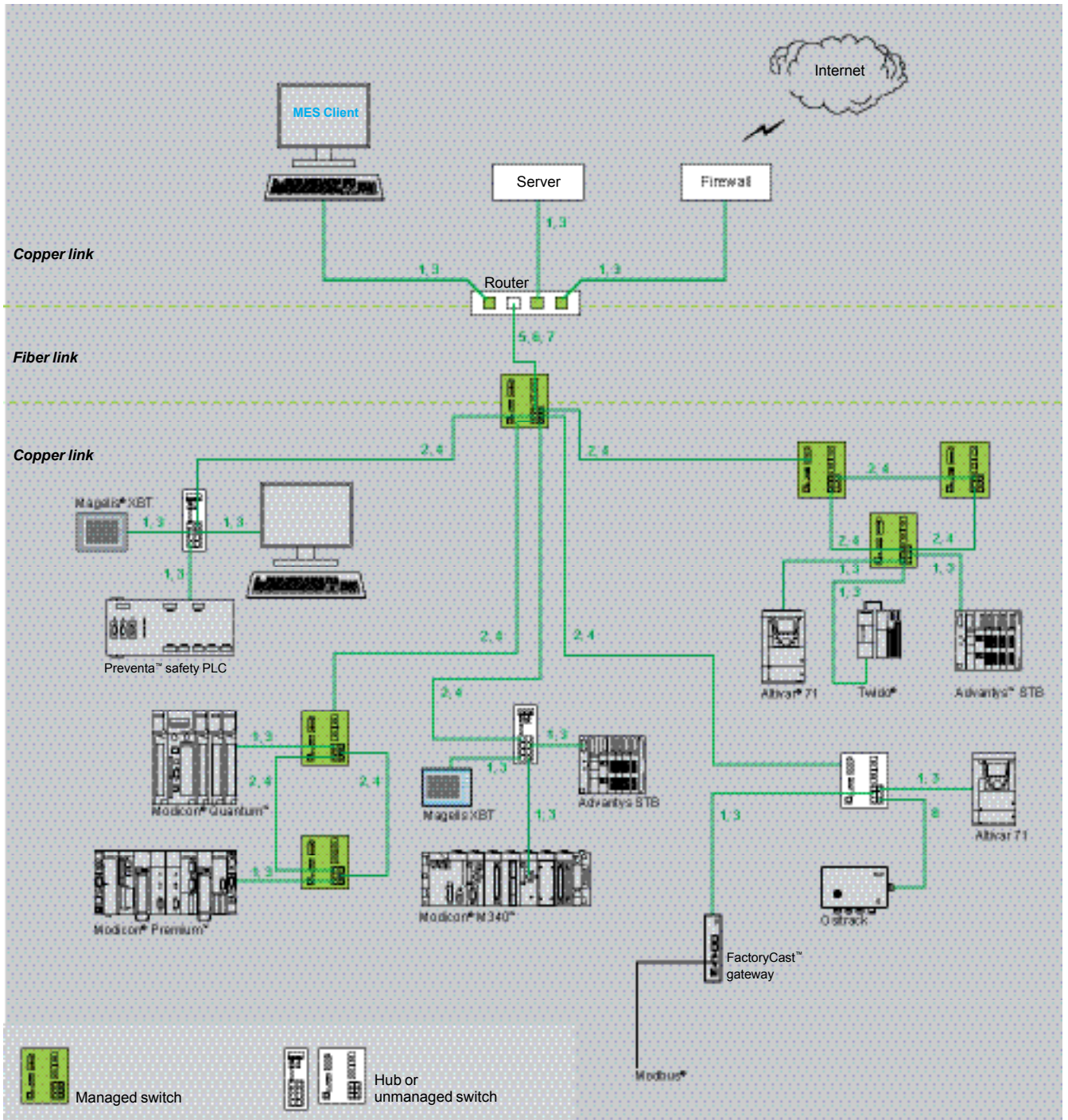

For key:  
 1, 3: Straight cables,  
 2, 4: Crossed cord cables,  
 5, 6, 7: Fiber-optic cables,  
 8: Cables with IP 67 connector,  
 see pages 5/50 and 5/51.

## Shielded copper connection cables

ConneXium™ shielded connection cables are available in two versions to meet the various current standards and approvals:

### ■ EIA/TIA 568 shielded twisted pair cables for C€ market

These cables conform to:

- EIA/TIA-568 standard, category CAT 5E,
- IEC 11801/EN 50173 standard, class D.

Their fire resistance conforms to:

- NF C32-070# C2 classification
- IEC 322/1 standards
- Low Smoke Zero Halogen (LSZH).

### ■ EIA/TIA 568 shielded twisted pair cables for UL market

The cable material is:

- CEC type FT-1
- NEC type CM.



490 NT•000•••

### EIA/TIA 568 shielded twisted pair cables for C€ market

Description	Preformed at both ends	Rep.	Length m (ft)	Reference	Weight kg
<b>Straight cables</b>	2 RJ45 connectors For connection to terminal devices (DTE)	1	2 (6.6)	490 NTW 000 02	–
			5 (16.4)	490 NTW 000 05	–
			12 (39.4)	490 NTW 000 12	–
			40 (131.2)	490 NTW 000 40	–
			80 (262.5)	490 NTW 000 80	–
<b>Crossed cord cables</b>	2 RJ45 connectors For connections between hubs, switches and transceivers	2	5 (16.4)	490 NTC 000 05	–
			15 (49.2)	490 NTC 000 15	–
			40 (131.2)	490 NTC 000 40	–
			80 (262.5)	490 NTC 000 80	–

### EIA/TIA 568 shielded twisted pair cables for UL market

Description	Preformed at both ends	Rep.	Length m (ft)	Reference	Weight kg
<b>Straight cables</b>	2 RJ45 connectors For connection to terminal devices (DTE)	3	2 (6.6)	490 NTW 000 02U	–
			5 (16.4)	490 NTW 000 05U	–
			12 (39.4)	490 NTW 000 12U	–
			40 (131.2)	490 NTW 000 40U	–
			80 (262.5)	490 NTW 000 80U	–
<b>Crossed cord cables</b>	2 RJ45 connectors For connections between hubs, switches and transceivers	4	5 (16.4)	490 NTC 000 05U	–
			40 (131.2)	490 NTC 000 40U	–
			80 (262.5)	490 NTC 000 80U	–

### “Do it Yourself” cable and connectors

The “Do It Yourself” offer is comprised of 2 references for “field installable” connectors (M12 and RJ45) and one reference for spooled cable measuring 300 m. The product are intended for use in industrial Ethernet networks supporting transmission rates up to 100 Mbit/s over the combined maximum cable length up to 80 m. Quick on the floor assembly with only a knife and pliers.

Description	According to	Length m (ft)	Reference	Weight kg
<b>Ethernet copper cable</b> 2 shielded twisted pairs 24 AWG	EIA/TIA-568 (80 m max. link length) UL 508-CM, C€ EN 50173 Class D	300 m (1000)	TCS ECN 300R2	–
<b>RJ45 connector</b> IP 20	EIA/TIA-568-D, category CAT 5E, C€	–	TCS EK3 MDS	–
<b>M12 connector</b> D-Code, IP 65/67	IEC 60176-2-101, EN 50173 Class D	–	TCS EK1 MDRS	–

(1) For key to numbers, see pages 5/48 and 5/49.

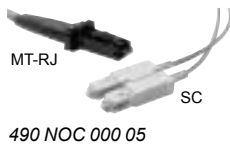

### Glass fiber-optic cables

These glass fiber-optics are for making connections:

- To a terminal device (DTE)
- Between hubs, transceivers and switches

Description	Preformed at both ends	Rep.	Length m (ft)	Reference	Weight kg
Glass fiber-optic cables	1 SC connector 1 MT-RJ connector	5	5 (16.4)	490 NOC 000 05	–
	1 ST connector (BFOC) 1 MT-RJ connector	6	5 (16.4)	490 NOT 000 05	–
	2 MT-RJ connectors	7	3 (9.8)	490 NOR 000 03	–
			5 (16.4)	490 NOR 000 05	–

### Separate parts for TCS ESM switches

Description	Optical fiber	Type	Reference	Weight kg
Fiber-optic modules for Gigabit ports with LC connector (1)	Multimode 50/125 µm or 62.5/125µm	1000BASE-SX	TCS EAA F1LFU00	0.040
	Single mode 9/125 µm	1000BASE-LH	TCS EAA F1LFH00	0.040
	Multimode 50/125 µm or 62.5/125 µm Single mode 62.5/125 µm	1000BASE-LX	TCS EAA F1LFS00	0.040
Configuration backup key	Via the USB port on the front of the switch, used to: - save and retrieve the switch configuration - update the internal software		TCS EAM 0100	–

(1) Dimensions W x H x D = 20 x 18 x 50 mm.

### Connection components for IP 67 switch

Description	Preformed at both ends	Rep.	Length m (ft)	Reference	Weight kg
Copper cables	1 IP 67 4-way M12 connector and 1 RJ45 connector	8	1 (3.3)	TCS ECL 1M3M 1S2	–
			3 (9.8)	TCS ECL 1M3M 3S2	–
			10 (32.8)	TCS ECL 1M3M 10S2	–
			25 (82)	TCS ECL 1M3M 25S2	–
			40 (131.2)	TCS ECL 1M3M 40S2	–
	2 IP 67 4-way M12 connectors	–	1 (3.3)	TCS ECL 1M1M 1S2	–
			3 (9.8)	TCS ECL 1M1M 3S2	–
			10 (32.8)	TCS ECL 1M1M 10S2	–
			25 (82)	TCS ECL 1M1M 25S2	–
			40 (131.2)	TCS ECL 1M1M 40S2	–
Power cables	Female M12 straight connector	–	2 (6.6)	XZC P1164L2	–
			5 (16.4)	XZC P1164L5	–
	Female M12 elbowed connector	–	2.5 (8.2)	XZC P1264L2	–
			5 (16.4)	XZC P1264L5	–
Power connectors	Female M12 straight connector	–	–	XZC C12 FDM 50B	–
				XZC C12 FCM 50B	–
M12/RJ45 adaptor	IP 67 female 4-way M12 connector and female RJ45 connector	–	–	TCS EAA F11F13F00	–

## Presentation

Hubs (*concentrators*) are used for transmitting signals between several media (ports). Hubs are “plug and play” devices that do not need any configuration. The use of hubs makes it possible to create the following topologies:

- Star topology using hubs
- Tree topology using hubs

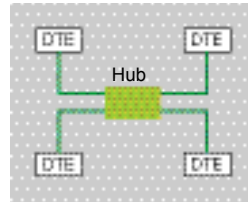

Star topology

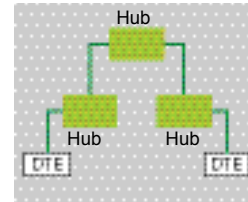

Tree topology

## Characteristics and references

Transparent  
Ready.



5

Hubs			
<b>Interfaces</b>	Copper cable ports	Number and type	4 x 10BASE-T ports
		Shielded connectors	RJ45
		Medium	Shielded twisted pair, category CAT 5E
		Total length of pair	100 m
	Fiber-optic ports	Number and type	–
<b>Topology</b>	Number of cascaded hubs		max. 4
	Number of hubs in a ring		–
<b>Redundancy</b>			P1 and P2 redundant power supplies
<b>Power supply</b>	Voltage		24 V (18...32) ---, safety extra low voltage (SELV)
	Power consumption		80 mA (130 max. at 24 V ---)
	Removable connector		5-way
<b>Operating temperature</b>			0...+ 60 °C
<b>Relative humidity</b>			10...95% non condensing
<b>Degree of protection</b>			IP 30
<b>Dimensions</b>	W x H x D		40 x 125 x 80 mm
<b>Mounting</b>			On symmetrical DIN rail, 35 mm wide
<b>Weight</b>			0.530 kg
<b>Conformity to standards</b>			cUL 60950, UL 508 and CSA 22.2 No. 142, UL 1604 and CSA 22.2 No. 213 Class 1 Division 2, CE, GL, C-Tick FM 3810, FM 3611 Class 1 Division 2
<b>LED indicators</b>			Power supply, activity, link
<b>Alarm relay</b>			Power supply inoperative, detected Ethernet network fault or detected communication port fault (1 A max. volt-free contact at 24 V ---)
<b>Reference</b>			499 NEH 104 10

## Presentation

The use of ConneXium™ transceivers makes it possible to perform the following:

- Creation of linear fiber-optic bus topologies, for products with twisted pair cable Ethernet connection.
- Interfacing products with twisted pair cable Ethernet connection with a fiber-optic cable.

Transceivers are “plug and play” devices that do not need any configuration.

ConneXium transceivers provide fiber-optic connections for transmission in areas subject to interference (high levels of electromagnetic interference) and for long distance communications.

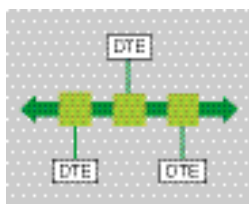

Linear topology on optical fiber

## Characteristics and references

Transparent



Transceivers			
<b>Interfaces</b>	Copper cable ports	Number and type	1 x 100BASE-TX port
		Shielded connectors	RJ45
		Medium	Shielded twisted pair, category CAT 5E
		Total length of pair	100 m
	Fiber-optic ports	Number and type	1 x 100BASE-FX port
		Connectors	SC
		Medium	Multimode optical fiber
		Length of optical fiber	
		50/125 µm fiber	3000 m (1)
		62.2/125 µm fiber	3000 m (1)
Attenuation analysis	50/125 µm fiber	8 dB	
	62.2/125 µm fiber	11 dB	
<b>Redundancy</b>			P1 and P2 redundant power supplies
<b>Power supply</b>	Voltage		24 V (18...32) ---, safety extra low voltage (SELV)
	Power consumption		160 mA (190 max. at 24 V ---)
	Removable connector		5-way
<b>Operating temperature</b>			0...+ 60 °C
<b>Relative humidity</b>			10...95% non condensing
<b>Degree of protection</b>			IP 20
<b>Dimensions</b>	W x H x D		47 x 135 x 111 mm
<b>Mounting</b>			On symmetrical DIN rail, 35 mm wide
<b>Weight</b>			0.230 kg
<b>Conformity to standards</b>			cUL 60950, UL 508 and CSA 22.2 No. 142, UL 1604 and CSA 22.2 No. 213 Class 1 Division 2, CE, GL, C-Tick
<b>LED indicators</b>			P1 and P2 power supplies, Ethernet link/port status
<b>Alarm relay</b>			Power supply inoperative, detected Ethernet network fault or detected communication port fault (1 A max. volt-free contact at 24 V ---)
<b>Reference</b>			<b>499 NTR 101 00</b>

(1) Length dependent on the attenuation analysis and attenuation of the optical fiber (typical value: 2000 m).

## Presentation

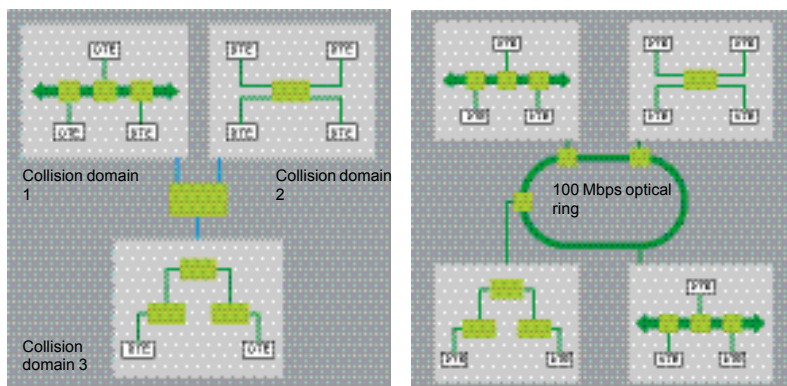

Switches are used to increase the limits of architectures based on hubs or transceivers, by separating collision domains. Higher layer communication is provided between the ports, and collisions at link layer are not propagated (filtering). They therefore improve performance by better allocation of the pass band due to the reduction of collisions and the network load. Certain ConneXium™ switch models also enable redundant architectures to be created on twisted pair copper ring or fiber-optic.

Switches are “plug & play” devices that do not need any configuration. They can also be managed remotely via the SNMP or HTTP protocols for monitoring and diagnostics purposes.

## Characteristics and references: twisted pair

Transparent  
Ready.



5

Switches			Copper twisted pair, unmanaged				
Interfaces	Copper cable ports	Number and type	5 x 10BASE-T/ 100BASE-TX ports		8 10BASE-T/100BASE-TX ports		
		Shielded connectors	M12 (type D)		RJ45		
		Medium	Shielded twisted pair, category CAT 5E				
		Total length of pair	100 m				
		Ethernet services	Storage and re-routing of received data, auto MDI/MDX, automatic negotiation of 10/100 Mbit/s and duplex mode (on each port), automatic change of polarity				-
Topology	Number of switches	Cascaded	Unlimited				
		Redundant in a ring	-				
Redundancy			-		P1 and P2 redundant power supplies		
Power supply	Voltage	24 V ~ (18...32) safety extra low voltage (SELV)					
	Power consumption	mA max.	100		125 (290 max.)		
	Removable connector	5-way M12 (type A, male)				5-way	
Operating temperature			0...+ 60 °C				
Relative humidity			-		10...95% non condensing		
Degree of protection			IP 67		IP 20		
Dimensions		W x H x D	60 x 126 x 31 mm		47 x 135 x 111 mm		
Mounting			On symmetrical DIN rail, 35 mm wide				
Weight			0.210 kg		0.230 kg		
Conformity to standards			cUL 508 and CSA 22.2 No. 142		cUL 60950, UL 508 and CSA 22.2 No. 142, UL 1604 and CSA 22.2 No. 213 Class 1 Division 2, CE, GL, C-Tick		
LED indicators			Power supply, link status, line activity		P1 and P2 power supplies, Ethernet link/port status		
Alarm relay			-		Power supply inoperative, detected Ethernet network fault or detected communication port fault (1 A max. volt-free contact at 24 V ~)		
Reference			TCS ESU 051F0		499 NES 181 00		
IP 67 cordsets							
Ethernet cordsets			Preformed at each end, see page 9/26 of this catalog.				
Power supply cables			Preformed at each end with M12 female straight connectors		Preformed at each end with female M12 angled connectors		
			Length 2 m	Length 5 m	Length 2 m	Length 5 m	
Reference			XZC P1164L2	XZC P1164L5	XZC P1264L2	XZC P1264L5	
Spare power connectors			Female M12 straight connector		Female M12 angled connector		
Reference			XZC C12 FDM 50B		XZC C12 FCM 50B		



**Characteristics and references : 3, 4 and 5 ports, twisted pair, fiber-optic**



Switches			Copper twisted pair, unmanaged			
<b>Interfaces</b>	Copper cable ports	Number and type	3 x 10BASE-T/ 100BASE-TX ports	4 x 10BASE-T/ 100BASE-TX ports	5 x 10BASE-T/ 100BASE-TX ports	
		Shielded connectors	RJ45			
		Medium	Shielded twisted pair, category CAT 5E			
		Total length of pair	100 m			
	Fiber-optic ports	Number and type	–	1 x 100BASE-FX ports	–	
		Connectors	–	Duplex SC	–	
		Medium	–	Multimode optical fiber	–	
		Length of optical fiber	50/125 µm fiber	–	5000 m (1)	–
			62,2/125 µm fiber	–	4000 m (1)	–
		Attenuation analys	50/125 µm fiber	–	8 dB	–
62,2/125 µm fiber	–		11 dB	–		
Ethernet services	Storage and re-routing of received data, auto MDI/MDX (automatic switching depending on whether cables are straight or crossed), automatic negotiation of 10/100 Mbit/s and duplex mode (on each port), automatic change of polarity					
<b>Topology</b>	Number of switches	Cascaded	Unlimited			
		Redundant in a ring	–			
<b>Redundancy</b>						
<b>Power supply</b>	Voltage, safety extra low voltage (SELV)		~ 24 V (~ 9,6...32 V)			
	Power consumption		Max. 2,2 W	Max. 3,9 W	Max. 2,2 W	
	Connector		3 way removable connector			
<b>Operating temperature</b>			0...+ 60°C			
<b>Relative humidity</b>			Max. 95 % non condensing			
<b>Degree of protection</b>			IP 30			
<b>Dimensions</b>		W x H x D	25 x 114 x 79 mm			
<b>Weight</b>			0,113 kg	0,120 kg	0,113 kg	
<b>Conformity to standards</b>			UL 508 and CSA 22.2 No.142 IEC/EN 61131-2, IEC 60825-1 class 1, CISPR 11A			
<b>LED indicators</b>			Power supply, copper port activity, 10 or 100 Mbit/s data rate			
			–	Fiber port state and activity	–	
<b>Alarm relay</b>			–			
<b>Référence</b>			<b>TCS ESU 033FN0</b>	<b>TCS ESU 043F1N0</b>	<b>TCS ESU 053FN0</b>	

(1) Length dependent on the attenuation analysis and attenuation of the fiber-optic (typical value: 2,000 m).

**Characteristics and references: 5 ports, twisted pair and fiber-optic**



Switches			Copper twisted pair and fiber-optic, unmanaged			
<b>Interfaces</b>	Copper cable ports	Number and type	4 x 10BASE-T/ 100BASE-TX ports	3 x 10BASE-T/ 100BASE-TX ports	4 x 10BASE-T/ 100BASE-TX ports	3 x 10BASE-T/ 100BASE-TX ports
		Shielded connectors	RJ45			
		Medium	Shielded twisted pair, category CAT 5E			
		Total length of pair	100 m			
	Fiber-optic ports	Number and type	1 x 100BASE-FX port	2 x 100BASE-FX ports	1 x 100BASE-FX port	2 x 100BASE-FX ports
		Connectors	SC			
		Medium	Multimode optical fiber		Single mode optical fiber	
		Length of optical fiber				
		50/125 µm fiber	5,000 m (1)		–	
		62.2/125 µm fiber	4,000 m (1)		–	
Attenuation analysis	9/125 µm fiber	–		32,500 m (2)		
	50/125 µm fiber	8 dB		–		
	62.2/125 µm fiber	11 dB		–		
	9/125 µm fiber	–		16 dB		
<b>Topology</b>	Number of switches	Cascaded	Unlimited			
		Redundant in a ring	–			
<b>Redundancy</b>	P1 and P2 redundant power supplies					
<b>Power supply</b>	Voltage	24 V $\bar{\text{---}}$ (18...32), safety extra low voltage (SELV)				
	Power consumption	mA max.	200	240	200	240
	Removable connector	5-way				
<b>Operating temperature</b>	-40...+70 °C					
<b>Relative humidity</b>	10...95% non condensing					
<b>Degree of protection</b>	IP 20					
<b>Dimensions</b>	W x H x D	47 x 135 x 111 mm				
<b>Mounting</b>	On symmetrical DIN rail, 35 mm wide					
<b>Weight</b>	0.330 kg		0.335 kg		0.330 kg	0.335 kg
<b>Conformity to standards</b>	cUL 60950, cUL 508 and CSA 22.2 No. 142, UL 1604 and CSA 22.2 No. 213 Class 1 Division 2, CE, GL, C-Tick					
<b>LED indicators</b>	P1 and P2 power supplies, Ethernet link status, transmission activity					
<b>Alarm relay</b>	Activity, power supply inoperative, detected Ethernet network fault or detected communication port fault (1 A max. volt-free contact at 24 V $\bar{\text{---}}$ )					
<b>Reference</b>	499 NMS 251 01		499 NMS 251 02		499 NSS 251 01	499 NSS 251 02

(1) Length dependent on the attenuation analysis and attenuation of the fiber-optic (typical value: 2,000 m).

(2) Length dependent on the attenuation analysis and attenuation of the fiber-optic (typical value: 15,000 m).

**Characteristics and references: 4 ports, twisted pair and fiber-optic**

Transparent  
Ready.



Switches			Copper twisted pair and fiber-optic, managed			
<b>Interfaces</b>	Copper cable ports	Number and type	3 x 10/100BASE-TX ports	2 x 10/100BASE-TX ports	3 x 10/100BASE-TX ports	2 x 10/100BASE-TX ports
		Shielded connectors	RJ45			
		Medium	Shielded twisted pair, category CAT 5E			
		Total length of pair	100 m			
	Fiber-optic ports	Number and type	1 x 100BASE-FX port	2 x 100BASE-FX ports	1 x 100BASE-FX port	2 x 100BASE-FX ports
		Connectors	Duplex SC			
		Medium	Multimode optical fiber		Single mode optical fiber	
		Length of optical fiber				
		50/125 µm fiber	5,000 m (1)		–	
		62.2/125 µm fiber	4,000 m (1)		–	
9/125 µm fiber		–		32,500 m (2)		
Attenuation analysis						
50/125 µm fiber	8 dB		–			
62.2/125 µm fiber	11 dB		–			
9/125 µm fiber	–		16 db			
Ethernet services		FDR, SMTP V3, SNMP client, multicast filtering for optimization of the Global Data protocol, configuration via Web access VLAN, IGMP Snooping, RSTP ( <i>Rapid Scanning Tree Protocol</i> ), priority port, data stream control, secure port				
<b>Topology</b>	Number of switches	Cascaded	Unlimited			
		Redundant in a ring	max. 50			
<b>Redundancy</b>		Redundant power supplies, redundant single ring, ring coupling				
<b>Power supply</b>	Voltage	Operation	9.6...60 V $\overline{\text{---}}$ /18...30 V $\sim$ , safety extra low voltage (SELV)			
	Power consumption		6.5 W	7.3 W	6.5 W	7.3 W
	Removable connector		6-way			
<b>Operating temperature</b>		0...+ 60 °C				
<b>Relative humidity</b>		10...90% non condensing				
<b>Degree of protection</b>		IP 20				
<b>Dimensions</b>		W x H x D	47 x 131 x 111 mm			
<b>Mounting</b>		On symmetrical DIN rail, 35 mm wide				
<b>Weight</b>		0.400 kg				
<b>Conformity to standards</b>		IEC/EN 61131-2, IEC 61850-3, UL 508, UL 1604 Class 1 Division 2, CSA 22.2 No. 214 (cUL), CSA 22.2 No. 213 Class 1 Division 2 (cUL), CE, GL, C-Tick				
<b>LED indicators</b>		Power supply status, alarm relay status, active redundancy, redundancy management, copper port status and copper port activity				
<b>Alarm relay</b>		Power supply inoperative, detected Ethernet network fault, detected communication port fault, improper redundancy fault (1 A max. volt-free contact at 24 V $\overline{\text{---}}$ )				
<b>Reference</b>		TCS ESM 043F1CU0	TCS ESM 043F2CU0	TCS ESM 043F1CS0	TCS ESM 043F2CS0	

(1) Length dependent on the attenuation analysis and attenuation of the fiber-optic (typical value: 2,000 m).

(2) Length dependent on the attenuation analysis and attenuation of the fiber-optic (typical value: 15,000 m).

**Characteristics and references: 4 and 8 ports, twisted pair**

Transparent  
Ready.



Switches			Copper twisted pair, managed	
<b>Interfaces</b>	Copper cable ports	Number and type	4 x 10/100BASE-TX ports	8 x 10/100BASE-TX ports
		Shielded connectors	RJ45	
		Medium	Shielded twisted pair, category CAT 5E	
		Total length of pair	100 m	
	Fiber-optic ports	Number and type	–	
		Connectors	–	
		Medium	–	
		Length of optical fiber	–	
		50/125 µm fiber	–	
		62.2/125 µm fiber	–	
		9/125 µm fiber	–	
	Ethernet services	Attenuation analysis	–	
		50/125 µm fiber	–	
62.2/125 µm fiber		–		
	9/125 µm fiber	–		
<b>Topology</b>	Number of switches	Cascaded	Unlimited	
		Redundant in a ring	max. 50	
<b>Redundancy</b>		Redundant power supplies, redundant single ring, ring coupling		
<b>Power supply</b>	Voltage	Operation	9.6...60 V $\overline{\text{---}}$ /18...30 V $\sim$ , safety extra low voltage (SELV)	
	Power consumption		5.3 W	5.3 W
	Removable connector		6-way	
<b>Operating temperature</b>		0...+60 °C		
<b>Relative humidity</b>		10...90% non condensing		
<b>Degree of protection</b>		IP 20		
<b>Dimensions</b>		W x H x D	47 x 131 x 111 mm	74 x 131 x 111 mm
<b>Mounting</b>		On symmetrical DIN rail, 35 mm wide		
<b>Weight</b>			0.400 kg	0.410 kg
<b>Conformity to standards</b>		IEC/EN 61131-2, IEC 61850-3, UL 508, UL 1604 Class 1 Division 2, CSA 22.2 No. 214 (cUL), CSA 22.2 No. 213 Class 1 Division 2 (cUL), CE, GL, C-Tick		
<b>LED indicators</b>		Power supply status, alarm relay status, active redundancy, redundancy management, copper port status and copper port activity	Power supply status, alarm relay status, active redundancy, redundancy management, fiber port status and fiber port activity	
<b>Alarm relay</b>		Power supply inoperative, detected Ethernet network fault or detected communication port fault (1 A max. volt-free contact at 24 V $\overline{\text{---}}$ )		
<b>Reference</b>		TCS ESM 043F23F0		TCS ESM 083F23F0

**Characteristics and references: 8 ports, twisted pair and fiber-optic**

Transparent  
Ready.



Switches			Copper twisted pair and fiber-optic, managed			
Interfaces	Copper cable ports	Number and type	7 x 10/100BASE-TX ports	6 x 10/100BASE-TX ports	7 x 10/100BASE-TX ports	6 x 10/100BASE-T ports
		Shielded connectors	RJ45			
		Medium	Shielded twisted pair, category CAT 5E			
		Total length of pair	100 m			
	Fiber-optic ports	Number and type	1 x 100BASE-FX port	2 x 100BASE-FX ports	1 x 100BASE-FX port	2 x 100BASE-FX ports
		Connectors	Duplex SC			
		Medium	Multimode optical fiber		Single mode optical fiber	
		Length of optical fiber	50/125 μm fiber		–	
			62.2/125 μm fiber		–	
			9/125 μm fiber		32,500 m (2)	
Ethernet services	Attenuation analysis		50/125 μm fiber		8 dB	
			62.2/125 μm fiber		11 dB	
			9/125 μm fiber		–	
Topology	Number of switches	Cascaded	Unlimited			
		Redundant in a ring	max. 50			
Redundancy			Redundant power supplies, redundant single ring, ring coupling			
Power supply	Voltage	Operation	9.6...60 V ~ / 18...30 V ~, safety extra low voltage (SELV)			
	Power consumption		6.5 W	7.3 W	6.5 W	7.3 W
	Removable connector		6-way			
Operating temperature			0...+60 °C			
Relative humidity			10...90% non condensing			
Degree of protection			IP 20			
Dimensions		W x H x D	74 x 131 x 111 mm			
Mounting			On symmetrical DIN rail, 35 mm wide			
Weight			0.410 kg			
Conformity to standards			IEC/EN 61131-2, IEC 61850-3, UL 508, UL 1604 Class 1 Division 2, CSA 22.2 No. 214 (cUL), CSA 22.2 No. 213 Class 1 Division 2 (cUL), CE, GL, C-Tick			
LED indicators			Power supply status, alarm relay status, active redundancy, redundancy management, fiber port status and fiber port activity			
Alarm relay			Power supply inoperative, detected Ethernet network fault or detected communication port fault (1 A max. volt-free contact at 24 V ~)			
Reference			TCS ESM 083F1CU0	TCS ESM 083F2CU0	TCS ESM 083F1CS0	TCS ESM 083F2CS0

(1) Length dependent on the attenuation analysis and attenuation of the fiber-optic (typical value: 2,000 m).

(2) Length dependent on the attenuation analysis and attenuation of the fiber-optic (typical value: 15,000 m).

**Characteristics and references: 16 and 24 ports, twisted pair, fiber-optic**

Transparent  
Ready.



Switches			Copper twisted pair, managed	Copper twisted pair and fiber-optic, managed		
Interfaces	Copper cable ports	Number and type	16 x 10/100BASE-TX ports	14 x 10/100BASE-TX ports	22 x 10/100BASE-TX ports	
		Shielded connectors	RJ45			
		Medium	Shielded twisted pair, category CAT 5E			
		Total length of pair	100 m			
	Fiber-optic ports	Number and type	–	2 x 100BASE-FX ports		
		Connectors	–	Duplex SC		
		Medium	–	Multimode optical fiber		
		Length of optical fiber	–	–		
		50/125 µm fiber	–	5,000 m (1)		
		62.2/125 µm fiber	–	4,000 m (1)		
		9/125 µm fiber	–	–		
	Ethernet services	Attenuation analysis	–	–		
		50/125 µm fiber	–	8 dB		
62.2/125 µm fiber		–	11 dB			
9/125 µm fiber		–	–			
Topology	Number of switches	Cascaded	Unlimited			
		Redundant in a ring	max. 50			
Redundancy			Redundant power supplies, redundant single ring, ring coupling			
Power supply	Voltage	Operation	9.6...60 V $\overline{\text{---}}$ /18...30 V $\sim$ , safety extra low voltage (SELV)			
	Power consumption		9.4 W	11.8 W	15.5 W	
	Removable connector		6-way			
Operating temperature			0...+ 60 °C			
Relative humidity			10... 90% non condensing			
Degree of protection			IP 20			
Dimensions		W x H x D	111 x 131 x 111 mm			
Mounting			On symmetrical DIN rail, 35 mm wide			
Weight			0.600 kg		0.650 kg	
Conformity to standards			cUL 60950, UL 508 and CSA 22.2 No 142, UL 1604 and CSA 22.2 No 213 Class 1 Division 2, CE, GL, C-Tick			
LED indicators			Redundant power supplies, single ring	Redundant power supplies, single ring, double ring		
Alarm relay			Power supply inoperative, detected Ethernet network fault or detected communication port fault (1 A max. volt-free contact at 24 V $\overline{\text{---}}$ )			
Reference			TCS ESM 163F23F0	TCS ESM 163F2CU0	TCS ESM 243F2CU0	

(1) Length dependent on the attenuation analysis and attenuation of the fiber-optic (typical value: 2,000 m).

**Characteristics and references: 8 ports and 2 Gigabit ports, twisted pair, fiber-optic**

Transparent  
Ready.



Switches			Copper twisted pair and fiber-optic, managed			Copper twisted pair, managed	
<b>Interfaces</b>	Copper cable ports	Number and type	8 x 10/100BASE-TX ports			8 x 10/100BASE-TX ports and 2 x 10/100/1000BASE-TX ports (Gigabit)	
		Shielded connectors	RJ45				
		Medium	Shielded twisted pair, category CAT 5E				
		Total length of pair	100 m				
	Gigabit ports fiber-optic (with SFP fiber module to be mounted on SFP connector)	Number and type	2 x 1000BASE-SX ports (1)	2 x 1000BASE-LH ports (2)	2 x 1000BASE-LX ports (3)	–	
		Connectors	LC			–	
		Medium	Multimode optical fiber	Single mode optical fiber	Single mode and multimode optical fiber	–	
		Length of optical fiber					
		50/125 µm fiber	550 m	–	550 m	–	
		62.2/125 µm fiber	275 m	–	550 m	–	
9/125 µm fiber	–	8 -72,000 m	20,000 m	–			
Attenuation analysis							
50/125 µm fiber	7.5 dB	–	11 dB	–			
62.2/125 µm fiber	7.5 dB	–	11 dB	–			
9/125 µm fiber	–	6 - 22 dB	11 dB	–			
Ethernet services	FDR, SMTP V3, SNMP client, multicast filtering for optimization of the Global Data protocol, configuration via Web access VLAN, IGMP Snooping, RSTP ( <i>Rapid Scanning Tree Protocol</i> ), priority port, data stream control, secure port						
<b>Topology</b>	Number of switches	Cascaded	Unlimited				
		Redundant in a ring	max. 50				
<b>Redundancy</b>	Redundant power supplies, redundant single ring, ring coupling						
<b>Power supply</b>	Voltage	Operation	9.6...60 V $\overline{\text{---}}$ /18...30 V $\sim$ , safety extra low voltage (SELV)				
	Power consumption		8.9 W + 1 W per SFP fiber module		8.3 W		
	Removable connector		6-way				
<b>Operating temperature</b>	0...+ 60 °C						
<b>Relative humidity</b>	10... 90% non condensing						
<b>Degree of protection</b>	IP 20						
<b>Dimensions</b>		W x H x D	111 x 131 x 111 mm				
<b>Mounting</b>	On symmetrical DIN rail, 35 mm wide						
<b>Weight</b>	0.410 kg						
<b>Conformity to standards</b>	cUL 60950, UL 508 and CSA 22.2 No. 142, UL 1604 and CSA 22.2 No. 213 Class 1 Division 2, C <sub>E</sub> , GL						
<b>LED indicators</b>	Power supply status, alarm relay status, active redundancy, redundancy management, fiber port status and fiber port activity						
<b>Alarm relay</b>	Power supply inoperative, detected Ethernet network fault or detected communication port fault (1 A max. volt-free contact at 24 V $\overline{\text{---}}$ )						
<b>Reference</b>	<b>TCS ESM 103F2LG0</b>			<b>TCS ESM 103F23G0</b>			

(1) With **TCS EAA F1LFU00** fiber-optic module to be ordered separately, see page 9/26.  
 (2) With **TCS EAA F1LFH00** fiber-optic module to be ordered separately, see page 9/26.  
 (3) With **TCS EAA F1LFS00** fiber-optic module to be ordered separately, see page 9/26.

# Modicon® Premium™ automation platform

## CANopen machines and installations bus

### Presentation

Originally used in the automotive industry, CAN is increasingly used in general industry. Several fieldbuses based on CAN lower layers and components are available. The CANopen machine bus conforms to the ISO 11898 international standard, promoted by the CAN In Automation Association, which consists of both users and manufacturers. This CANopen machine bus provides excellent open access and interoperability due to its standardized devices and communication profiles.

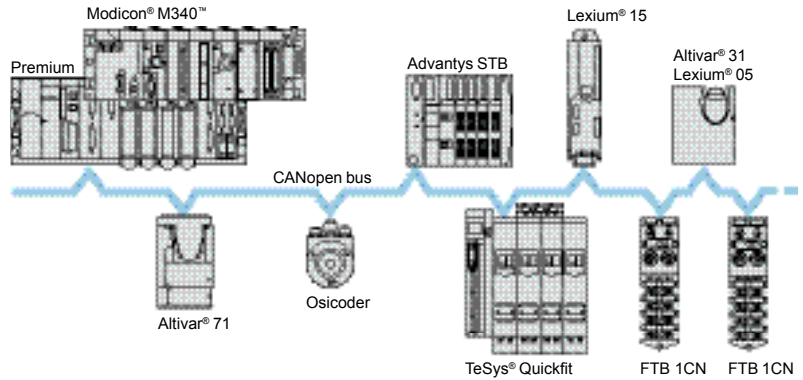

The CANopen bus is a multimaster bus which helps to ensure reliable deterministic access to realtime data in control system devices. The CSMA/CA protocol is based on broadcast exchanges, sent cyclically or on an event, which helps to ensure optimum use of the passband. A message handling channel can also be used to define slave parameters.

The bus uses a double shielded twisted pair, on which 127 devices maximum are connected by daisy chaining. The variable data rate between 20 Kbit/s and 1 Mbit/s depends on the length of the bus (between 2500 and 20 m). Each end of the bus must be fitted with a line terminator.

The CANopen bus is a set of profiles on CAN systems, possessing the following characteristics:

- Open bus system.
- Data exchanges in real-time without overloading the protocol.
- Modular design allowing modification of size.
- Interconnection and interchangeability of devices.
- Standardized configuration of networks.
- Access to device parameters.
- Synchronization and circulation of data from cyclic and/or event-controlled processes (short system response time).
- Interoperability between numerous international manufacturers.





TeSys model U



Advantys FTB



Altivar ATV 71



Lexium 05

Example of devices that can be connected on CANopen

## Connectable devices

The **TSX™ CPP 110** module performs the role of the master on the CANopen bus. Other Schneider Electric devices (slaves) which can be connected on the bus are:

- Osicoder Ø 58 mm multi-turn absolute encoders.
- TeSys® model U starter-controllers.
- TeSys® model D using the Quickfit installation assistance system.
- Advantys™ OTB, IP 20 Optimum distributed I/O
- Advantys™ STB, IP 20 modular distributed I/O.
- Advantys™ FTB, IP 67 monobloc I/O splitter boxes.
- Advantys™ FTM, IP 67 modular I/O splitter boxes.
- Preventa™ XPS MC, configurable safety controllers
- Altivar® 31, variable speed drives for asynchronous motors 0.18...15 kW.
- Altivar® 71/61, variable speed drives for asynchronous motors 0.75...630 kW.
- Lexium® 05, servo drives 0.4...6 kW for BSH servo motors.
- Lexium® 15, servo drives 0.9...42.5 kW for BDH and BSH servo motors.
- IclA intelligent compact motor-drives from Schneider Electric.

Also compatible:

- Any third-party device which conforms to the CANopen standard profile.
- Any CAN device which uses CAN V2.0B identifiers on the ISO 11898 physical layer.

The **TSX CPP 110** PCMCIA card supports the V4.02 CANopen standard with in particular the heartbeat network management.

## Description

The Modicon® TSX Micro™ and Modicon® Premium™ platforms connect to the CANopen bus by means of the **TSX CPP 110** type III PCMCIA card inserted in the processor or slot-PLC communication port slot.

The **TSX CPP 110** machine bus CANopen set is comprised of:

- 1 A PCMCIA card, type III with fixing screws.
- 2 A tap junction equipped with one 9-way SUB-D connector for connecting the CANopen bus.
- 3 A connection cable length 0.5 m, interdependent of the PCMCIA card and the tap junction.

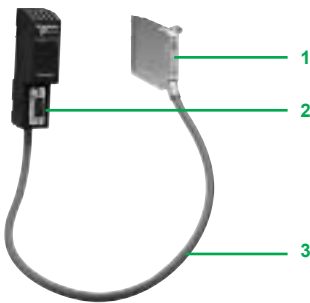

TSX CPP 110

### Software setup

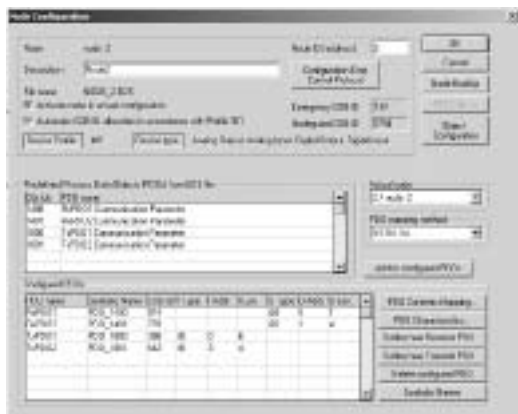

Example of SyCon configuration devices screen

The CANopen bus is configured using dedicated SyCon (1) software, which should be ordered separately, reference **SYS SPU LF● CD29M**.

This software is used:

- To describe devices connected on the bus.
- To generate the “.CO” file including the information relating to the devices connected. This extension file is imported into the PLC application via the PL7™ Micro/Junior/Pro programming software.

If the configuration file is too large in relation to the TSX Micro™/Premium™ processor capacity (see characteristics table), it is possible to load the master configuration directly by inserting the **TSX™ CPP 110** card in a PCMCIA port (type III) on the PC where SyCon® software has been installed.

In PL7™ or Unity™ Pro software (2), it is possible to configure the CANopen bus card so that the PLC processor/**TSX CPP 110** card exchanges are executed at the same rate as the master task or the fast task.

The process data exchanged with the slaves can be accessed by %MW standard words. The number of words depends on the type of processor and the task in which the module has been declared. PL7 or Unity Pro standard function blocks are used to define the device parameters.

**Note:** In addition to supporting the CANopen protocol which uses V2.0A standard CAN identifiers on 11 bits, the card enables direct access to the CAN link layer via CAN V2.0B identifiers on 29 bits, used by the majority of CAN devices. In certain applications this enables simultaneous control of CANopen devices and dedicated CAN products.

(1) The SyCon field bus configurator software also makes it possible to describe the I/O configuration of Profibus DP bus for Modicon Premium and Modicon Quantum platforms and the I/O configuration of INTERBUS bus for Modicon Quantum platform.

(2) PL7 Micro/Junior/Pro software is compatible with TSX Micro and Premium platforms, Unity Pro is compatible with Modicon M340, Premium and Quantum platforms.

5

### Characteristics

Type of bus		CANopen							
<b>Structure</b>	Type	Industrial bus							
	Physical interface	ISO 11898							
	Topology	Devices linked by daisy-chaining							
	Access method	CSMA/CA, multimaster, producer/consumer, priority information							
<b>Transmission</b>	Data rate	20 Kbit/s...1 Mbit/s depending on the length of bus							
	Medium	Double shielded twisted pair							
<b>Physical configuration</b>	Number of devices	127 max.							
	Length of bus according to data rate	<b>m</b>	1 Mbit/s 20	800 Kbit/s 45	500 Kbit/s 100	250 Kbit/s 250	125 Kbit/s 500	50 Kbit/s 1000	20 Kbit/s 2500
	Segments	Number	5 maxi (4 repeaters)						
		No. of devices per segment	64 devices		32 devices		16 devices		
		Max. length of segment	<b>m</b>	170	190		210		
Equivalent length of a repeater	<b>m</b>	15							
<b>Software configuration</b>			<b>Micro™ TSX 37 21 001/101 22 001/101</b>	<b>Premium™ PLCs TSX™ P57</b>			<b>453AM 4823AM 454M 4634M</b>	<b>554M 5634M</b>	<b>6634M</b>
	Size of configuration data (1)	<b>Ko</b>	0...8	0...12	16	32	64	64	64
	Max. size of CANopen I/O data	Master task	<b>words</b>	256 %MW	384 %MW	512 %MW	1024 %MW	3584 %MW	3584 %MW
Fast task		<b>words</b>	32 %MW	48 %MW	64 %MW	128 %MW	256 %MW	512 %MW	512 %MW

(1) This size can be exceeded if the configuration is loaded in the memory of CANopen PCMCIA card via the SyCon software.



TSX CPP 110

## References

### CANopen machines and installations bus set

Description	Services	No. of module per PLC/PC	Use	Reference	Weight kg
<b>CANopen master V4.02 PCMCIA card (type III)</b>	- PDO cyclic exchanges - CMS message handling (SDO) - management of bus operating modes	1 on Micro™ TSX 37 21/22 1 on Premium™ TSX P57 (1)	Supplied with a tap junction and cable length 0.5 m	<b>TSX™ CPP 110</b>	0.230

### Sycon® configuration software

The SyCon software is the configurator for machine bus and field bus of Schneider Electric. It supports the buses:

- CANopen for TSX Micro™ and Premium™ platforms.
- Profibus DP™ for Premium and Quantum™ platforms.
- INTERBUS® for Quantum platform.

The SyCon tool includes also the device description for Schneider Electric I/O modules.

Description	Type	Reference	Weight kg
<b>SyCon® V2.9 configuration software licenses</b>	Single (1station)	<b>SYS SPU LFU CD29M</b>	–
	Group (3 stations)	<b>SYS SPU LFG CD29M</b>	–
	Team (10 stations)	<b>SYS SPU LFT CD29M</b>	–
	Site (up to 10 stations)	<b>SYS SPU LFF CD29M</b>	–
<b>SyCon V2.9 configuration software update</b>	Single (1station)	<b>SYS SPU LRU CD29M</b>	–
<b>SyCon V2.9 configuration software upgrade for previous version</b>	Group (3 stations)	<b>SYS SPU LUG CD29M</b>	–
	Team (10 stations)	<b>SYS SPU LUT CD29M</b>	–
	Site (up to 10 stations)	<b>SYS SPU LUF CD29M</b>	–

(1) Unauthorized on **TSX P57 153M Premium** processor.

## CANopen bus wiring system

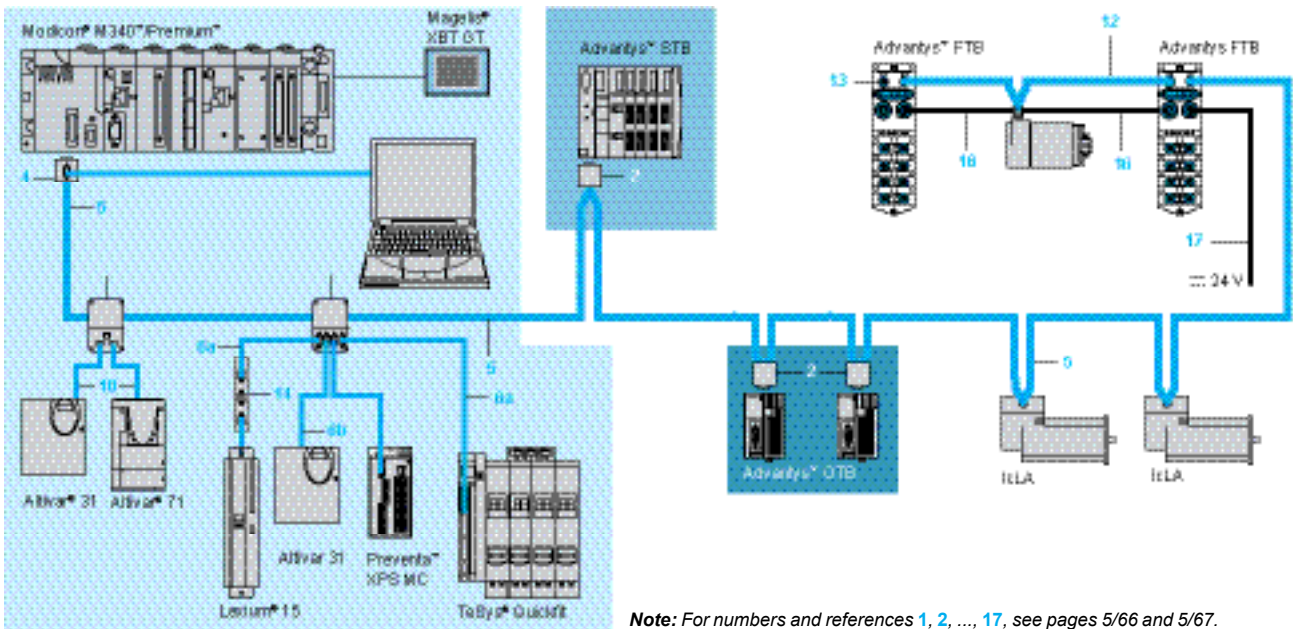

**Note:** For numbers and references 1, 2, ..., 17, see pages 5/66 and 5/67.

Different types of cable are available making it possible to create any type of application, including for harsh environments (for a definition of standard and harsh environments, see page 5/66).

Several connectors are available to meet any requirement: straight or 90° angled connectors, or angled connectors with the option of connecting a PC or diagnostic pocket PC.

Power can be supplied to the equipment by means of cables, cordsets and tap junctions: one AWG24 pair for the CAN signals, one AWG22 pair for the power supply and the ground.

In addition to the IP 20 wiring offer, there is also an IP 67 wiring offer.



TSX CAN TDM4

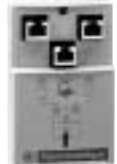

VW3 CAN TAP2



TSX CAN KCD F90T



TSX CAN KCD F180T



TSX CAN KCD F90TP

### Standard tap junctions and connectors

Designation	Description	No. (1)	Length	Reference	Weight kg
<b>IP 20 CANopen tap junction</b>	4 SUB-D ports. Screw terminal block for connection of trunk cables Line termination	1	–	TSX™ CAN TDM4	0.196
<b>IP 20 connectors</b> CANopen female	90° angled	2	–	TSX CAN KCDF 90T	0.046
	Straight (2)	–	–	TSX CAN KCDF 180T	0.049
	90° angled with 9-way SUB-D for connecting a PC or diagnostic tool	4	–	TSX CAN KCDF 90TP	0.051
<b>IP 67 M12 connectors</b>	Male	–	–	FTX CN 12M5	0.050
	Female	–	–	FTX CN 12F5	0.050
<b>IP 20 CANopen tap junctions</b> for Altivar® and Lexium® 05	2 RJ45 ports	9	–	VW3 CAN TAP2	–

### IP 20 standard cables and preformed cordsets

Designation	Description	No. (1)	Length	Unit reference	Weight kg	
<b>CANopen cables</b> (AWG 24)	Standard, CE marking: low smoke. Halogen-free. Flame-retardant (IEC 60332-1)	5	50 m	TSX CAN CA50	4.930	
			100 m	TSX CAN CA100	8.800	
			300 m	TSX CAN CA300	24.560	
	Standard, UL certification, CE marking: flame-retardant (IEC 60332-2)	5	50 m	TSX CAN CB50	3.580	
			100 m	TSX CAN CB100	7.840	
			300 m	TSX CAN CB300	21.870	
	For harsh environments (3) or mobile installation, CE marking: low smoke. Halogen-free. Flame-retardant (IEC 60332-1). Resistance to oils	5	50 m	TSX CAN CD50	3.510	
			100 m	TSX CAN CD100	7.770	
			300 m	TSX CAN CD300	21.700	
	<b>CANopen preformed cordsets</b> One 9-way female SUB-D connector at each end (AWG 24)	Standard, CE marking: low smoke. Halogen-free. Flame-retardant (IEC 60332-1)	6a	0.3 m	TSX CAN CADD03	0.091
				1 m	TSX CAN CADD1	0.143
				3 m	TSX CAN CADD3	0.295
5 m				TSX CAN CADD5	0.440	
Standard, UL certification, CE marking: flame-retardant (IEC 60332-2)				6a	0.3 m	TSX CAN CBDD03
1 m		TSX CAN CBDD1	0.131			
3 m		TSX CAN CBDD3	0.268			
5 m		TSX CAN CBDD5	0.400			
<b>CANopen preformed cordsets</b> One 9-way SUB-D connector, One RJ45 connector (AWG 24)		6b	0.5 m		TCS CCN 4F3M05T	–
			1 m	TCS CCN 4F3M1T	–	
			VW3 M38 05 R010 (4)	–		
	3 m		TCS CCN 4F3M3T	–		
	<b>CANopen preformed cordsets</b> Two 9-way SUB-D connectors, one male and one female		–	0.5 m	TLA CD CBA 005	–
1.5 m		TLA CD CBA 015		–		
3 m		TLA CD CBA 030		–		
5 m		TLA CD CBA 050		–		

### IP 67 standard preformed cordsets

Designation	Description	No. (1)	Length	Unit reference	Weight kg
<b>CANopen preformed cordsets</b>	Preformed cordsets of two 5-way M12 A-coded angled connectors (one male connector and one female connector)	12	0.3 m	FTX CN 3203	0.40
			0.6 m	FTX CN 3206	0.70
			1 m	FTX CN 3210	0.100
			2 m	FTX CN 3220	0.160
			3 m	FTX CN 3230	0.220
			5 m	FTX CN 3250	0.430

(1) For numbers, see page 5/65.

(2) For connection to Controller Inside programmable card, the VW3 CAN KCDF 180T connector can also be used.

(3) **Standard environment:**

- Without any particular environmental constraints
- Operating temperature between +5°C and +60°C
- Fixed installation

**Harsh environment:**

- Resistance to hydrocarbons, industrial oils, detergents, solder splashes
- Relative humidity up to 100%
- Saline atmosphere
- Significant temperature variations
- Operating temperature between -10°C and +70°C
- Mobile installation

(4) Cordset included the lime termination.



VW3 CAN A71



AM0 2CA 001V000

### IP 20 connection accessories

Designation	Description	No. (1)	Length	Unit reference	Weight kg
<b>CANopen connector for Altivar® 71 drive (2)</b>	9-way female SUB-D. Switch for line termination. Cables exit at 180°	–	–	<b>VW3 CAN KCDF 180T</b>	–
<b>Adaptor for Altivar 71 drive</b>	CANopen adaptor SUB-D to RJ45	–	–	<b>VW3 CAN A71</b>	–
<b>Preformed CANopen cordsets for Altivar® and Lexium® 05 drives</b>	One RJ45 connector at each end	<b>10</b>	0.3 m 1 m	<b>VW3 CAN CARR03</b> <b>VW3 CAN CARR1</b>	–
<b>CANopen bus adaptor for Lexium® 15 servo drive</b>	Hardware interface for a link conforming to the CANopen standard + one connector for a PC terminal	<b>14</b>	–	<b>AM0 2CA 001V000</b>	0.110
<b>Y-connector</b>	CANopen/Modbus®	–	–	<b>TCS CTN011M11F</b>	–

### IP 67 connection accessories

#### For Modicon® FTB monobloc I/O splitter boxes

Designation	Composition	No. (1)	Length m	Reference	Weight kg
<b>IP 67 line terminator</b>	Equipped with one M12 connector (for end of bus)	<b>13</b>	–	<b>FTX CNTL12</b>	0.010
<b>24 V ~ power supply connection cables</b>	Equipped with two 5-way 7/8 connectors	<b>16</b>	0.6	<b>FTX DP2206</b> <b>FTX DP2210</b> <b>FTX DP2220</b> <b>FTX DP2250</b>	0.150 0.190 0.310 0.750
	Equipped with one 5-way 7/8 connector at one end and flying leads at the other end	<b>17</b>	1.5	<b>FTX DP2115</b> <b>FTX DP2130</b> <b>FTX DP2150</b>	0.240 0.430 0.700
<b>T-junction box for power supply</b>	Equipped with two 5-way 7/8 connectors	–	–	<b>FTX CNCT1</b>	0,100



FTX DP21●●



XZ CC12●DM50B



XZ CC12●CM50B



FTX CY1208

### Separate parts

Designation	Composition	Sold in lot of	Reference	Weight kg
<b>Connectors</b>	7/8 type, 5-way	Male	–	<b>FTX C78M5</b> 0.050
		Female	–	<b>FTX C78F5</b> 0.050
	Straight, M12 type, 5 screw terminals	Male	–	<b>XZ CC12MDM50B</b> 0.020
		Female	–	<b>XZ CC12FDM50B</b> 0.020
	Angled, M12 type, 5 screw terminals	Male	–	<b>XZ CC12MCM50B</b> 0.020
		Female	–	<b>XZ CC12FCM50B</b> 0.020
<b>Sealing plugs</b>	For M8 connector (sold in packs of 10)	–	<b>FTX CM08B</b> 0.100	
	For M12 connector (sold in packs of 10)	–	<b>FTX CM12B</b> 0.100	
	For 7/8 connector	–	<b>FTX C78B</b> 0.020	
<b>Y-connector</b>	Connection of two M8 connectors to M12 connector on splitter box	–	<b>FTX CY1208</b> 0.020	
	Connection of two M12 connectors to M12 connector on splitter box	–	<b>FTX CY1212</b> 0.030	
<b>Diagnostics adaptor</b>	Equipped with two M12 connectors	–	<b>FTX DG12</b> 0.020	
<b>Marker labels</b>	For plastic splitter boxes	<b>10</b>	<b>FTX BLA10</b> 0.010	
	For metal splitter boxes	<b>10</b>	<b>FTX MLA10</b> 0.010	

(1) For numbers, see page 5/65.

(2) For ATV 71H●●●M3, ATV 71HD11M3X, HD15M3X, ATV 71H075N4... HD18N4 drives, this connector can be replaced by the **TSX CAN KCDF 180T** connector

# Modicon® Premium™ automation platform

## TSX™ SAY master module for AS-Interface® cabling system

### Presentation

**TSX™ SAY 1000** master module for the AS-Interface® cabling system enables the Premium™ PLC to act as the AS-Interface master.

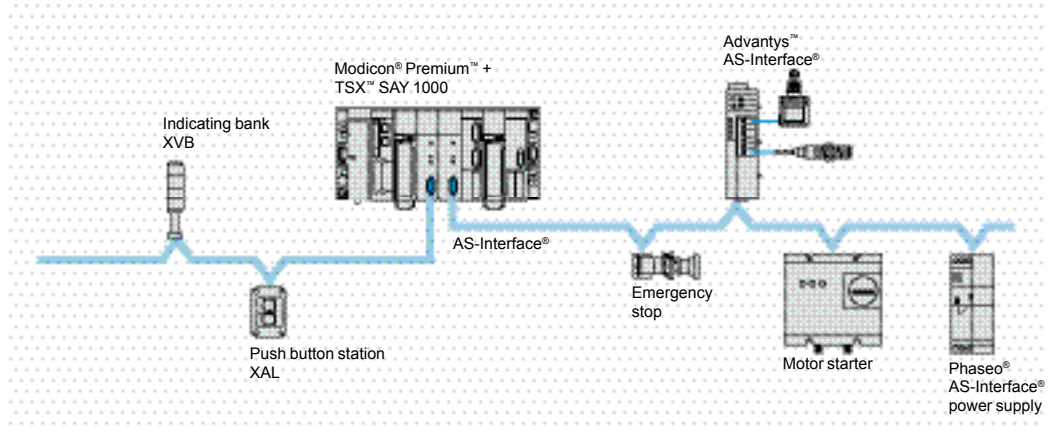

The AS-Interface cabling system is comprised of a master station (Premium PLC) and slave stations. The master that supports the AS-Interface profile successively interrogates the devices connected on the AS-Interface cabling system and stores the data (status of sensor/actuators, operational status of devices) in the PLC memory. Communication management on the AS-Interface line is completely transparent with regard to the PLC application program.

**TSX SAY 1000** master module with the AS-Interface M2E profile (AS-Interface V2) manages:

- Discrete slave devices (a maximum of 62 devices organized in 2 banks, A/B, with 31 addresses each),
- Analog devices (a maximum of 31 devices in bank A)
- Safety interfaces (a maximum of 31 devices in bank A).

The maximum number of **TSX SAY 1000** modules per PLC station or slot-PLC is either 1, 2, 4 or 8, depending on the type of processor or slot-PLC installed (see page 5/69).

An AS-Interface power supply must be used for powering the various devices on the line. Ideally, this power supply should be situated nearest to the stations with the largest power demands (see pages 8/37).

### Description

**TSX SAY 1000** AS-Interface master module is standard format modules. Modules of this format are designed to slot into any position on the Premium PLC rack like any Input/Output module or application-specific module. The modules feature, on the front panel:

- 1 A display unit comprising 4 indicator lamps showing the module operating modes:
  - RUN indicator lamp (green): module operating,
  - ERR indicator lamp (red): module detected fault,
  - A/B indicator lamp (green): display of group of 32 slaves,
  - I/O indicator lamp (red): AS-Interface line I/O detected fault.
- 2 A display unit comprising 32 indicator lamps for diagnostics of the AS-Interface line and of each slave connected to the line depending on the A/B pushbutton selected (1).
- 3 Two or three indicator lamps specific to the module: see diagnostics on page 9/69.
- 4 Two pushbuttons: see diagnostics on page 9/69.
- 5 One 3-way male SUB-D connector for connection to the AS-Interface cable (female screw connector supplied).

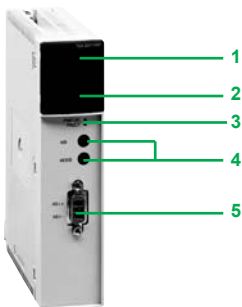

TSX SAY 1000

(1) Depending on the selection made with the A/B pushbutton, the first 31 slaves (standard address settings) or the last 31 slaves (extended address settings with AS-Interface V2) are displayed.

# Modicon® Premium™ automation platform

## TSX™ SAY master module for AS-Interface® cabling system

### Diagnostics

#### TSX™ SAY 1000 module (AS-Interface® V2)

The two indicator lamps **3** on the front panel of the **TSX SAY 1000** module that correspond to the two pushbuttons **4** are used for diagnostics at module level:

#### Indicator lamps marked:

PWR:  
AS-Interface  
power supply  
present

FAULT: AS-Interface line detected  
fault

#### Pushbuttons marked:

A/B: selection of  
slave group on  
display unit **2**

MODE: module  
Off line/On line

The display unit on the front panel of the **TSX SAY 1000** master module allows simplified local diagnostics to be performed by displaying the slave devices on the AS-Interface line. Detailed diagnostics for each of these slave devices can be carried out via the **ASI Terv2** adjustment console.

### References

Description	Number per PLC	Profile	Max. number of I/Os (1)	Reference	Weight kg
<b>AS-Interface® master module (2) for Premium™ PLCs</b>	1 for 57 0● 2 for 57 1● 4 for 57 2● 8 for 57 3● 8 for 57 4● 8 for 57 5● 8 for 57 6●	AS-Interface M2E	62 discrete devices 31 analog devices (3) 31 safety devices	<b>TSX™ SAY 1000</b>	0.340

#### Connection accessories (4)

Description	Supply	Length	Reference	Weight kg
<b>AS-Interface ribbon cables (yellow)</b>	For AS-Interface line	20 m	<b>XZ CB 10201</b>	1.400
		50 m	<b>XZ CB 10501</b>	3.500
		100 m	<b>XZ CB 11001</b>	7.000



TSX SAY 1000

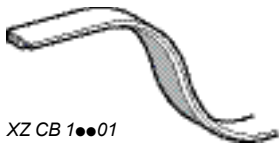

XZ CB 10001

- (1) These maximum values cannot be cumulated: see the characteristics on page 5/71  
 (2) The 3-way SUB-D connector for connection to the AS-Interface cable is supplied with the module.  
 (3) Supports analog devices that have between 1 and 4 input or output channels.  
 (4) For another connection accessories, see page 5/73.

### Connections

#### TSX SAY 1000 module

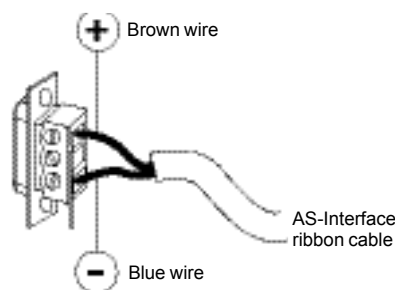

# Modicon® Premium™ automation platform

## Master modules for AS-Interface® cabling system

### Software setup

The AS-Interface® cabling system is configured using Unity™ Pro or PL7™ Micro/Junior/Pro software. Features include:

- Management of profile tables, parameters and data by the master (this management is transparent to the user).
- Topological I/O addressing: each AS-Interface slave declared on the line is assigned a topological address on the bus. This is transparent to the user.
- Each sensor/actuator for the AS-Interface is treated as an in-rack I/O by the TSX Micro™/Premium™ PLC.

### AS-Interface® cabling system configuration

Devices on the AS-Interface line are configured implicitly using the following sequence of screens:

Declaration of the AS-Interface master module

- The TSX™ SAZ 10 module is always inserted and declared in position no. 4 on TSX™ 37 10/21/22 TSX Micro automation platforms.
- TSX™ SAY 1000 modules can be inserted into any position on Modicon® Premium™ automation platforms (except positions reserved for processors and power supplies).

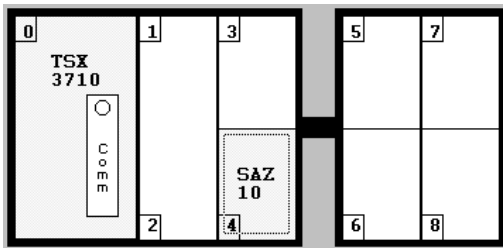

Declaration of the TSX SAZ 10 TSX Micro module

Configuration of AS-Interface slave devices

Using the configuration screen, it is possible to configure the slave devices corresponding to interface I/Os on the AS-Interface cabling system. Depending on its type, the configuration for each device consists of defining, as appropriate:

- Schneider Electric AS-Interface devices. The user selects the AS-Interface device catalog reference from the various discrete, analog, or safety interfaces listed. This selection automatically determines the AS-Interface profile and the parameters associated with each interface.
- Third-party AS-Interface device. The user can use Unity™ Pro or PL7™ Micro/Junior software to manage a “customized” list of sensors/actuators of different brands. This list, specifying the AS-Interface profile and parameters, is compiled to meet the needs of the user.

### Programming

After configuration, the I/Os connected on the AS-Interface line are processed by the application program in the same way as an in-rack I/O of the PLC, using either the address (e.g. %I4.0\16.2, input 2 of slave 16 of the AS-Interface line), or the associated symbol (e.g. Start\_conveyor).

Unity Pro or PL7 Junior/Pro software has an integrated function block library containing the specific diagnostic DFBs for AS-Interface line. Its check for the appearance of any detected error on the AS-Interface (line or slaves) or, if they are present, on the AS-Interface “Safety at work” monitors **ASI SAFEMON**.

5

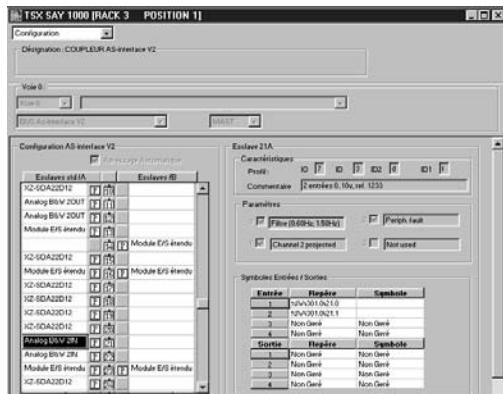

Configuration of AS-Interface slave devices in TSX SAY 1000 Premium module



## Diagnostics

Diagnostics performed using the centralized display unit of the TSX Micro™ platform or using the display unit of **TSX™ SAY 1000** module can be completed using a PC terminal on which Unity™ Pro or PL7™ Micro/Junior/Pro software has been installed.

The terminal connected to the TSX Micro™ or Premium™ PLC is used to perform diagnostics of the operating state of the:

- **TSX SAZ 10** and **TSX SAY 1000** master module,
- AS-Interface® line,
- Slave devices on the line.

For the AS-Interface V2 **TSX SAY 1000** master module, the diagnostics takes into account developments in the M2E standard.

Diagnostics are performed using a single screen divided into four sections providing information on:

- 1 Status of the **TSX™ SAZ 10** or **TSX SAY 1000** module (RUN, ERR, I/O).
- 2 Status of the AS-Interface channel connected to the module.
- 3 Inoperative interface (or slave).
- 4 Data relating to any selected interface (profile, parameters, forcing, etc).

In the event of an AS-Interface module or channel detected fault, a second screen can be accessed, which clearly shows the type of detected fault that may be at internal or external level.

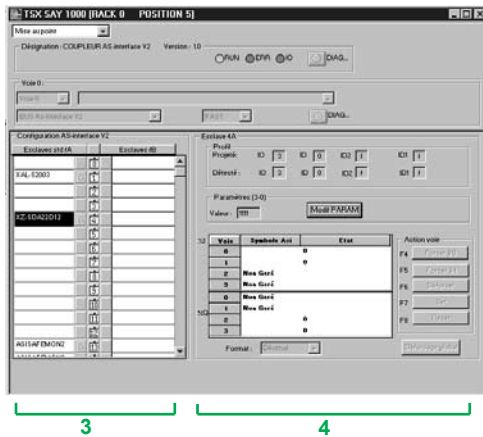

Diagnostics of the TSX SAY 1000 module using PL7

## Characteristics

Type of module	TSX™ SAZ 10	TSX™ SAY 1000
AS-Interface® profile	M2(AS-Interface V1)	M2E (AS-Interface V2)
Type of addressing	Standard	Standard and extended
Product certification	AS-Interface No. 12001, IEC/EN 61131-2	Pending
Ambient air temperature	Operation Storage	0...+60 °C. -25...+70 °C.
Degree of protection	IP 20	
Vibration resistance	Conforming to IEC/EN 60068-2-6. Fc tests.	
Shock resistance	Conforming to IEC 60068-2-27. EA tests.	
Number of connectable interfaces (or slaves)	With standard addressing With extended addressing	31 slaves 31 slaves
Type of connectable interfaces	With standard addressing With extended addressing	Discrete I/Os (4I/4O) Discrete I/Os (4I/3O) Analog I/Os (a maximum of 4 channels) Safety interfaces
Line connection	By terminal block inside module (polarity locating device)	By 3-way SUB-D connector (included with the module)
Module power supply	Via power supply integrated into the host platform of the module	
Display/diagnostics	Via: - centralized display unit on TSX Micro PLC or via the display unit of TSX SAY 1000 module - use of the Unity Pro or PL7 Micro/Junior/Pro software diagnostics function - use of the ASI-TERV1 adjustment console (infrared link)	

(1) If the interfaces are connected using extended addressing, the type of discrete I/Os is 4I/3O (instead of 4I/4O).

AS-Interface® flat cables are available in two versions, yellow and black, according to the type of application: standard and TPE (resistant to splashing oil and to environments with petroleum vapors). Various tap junctions are available to meet multiple cabling needs. They have a degree of protection of IP 67.

### AS-Interface® infrastructure

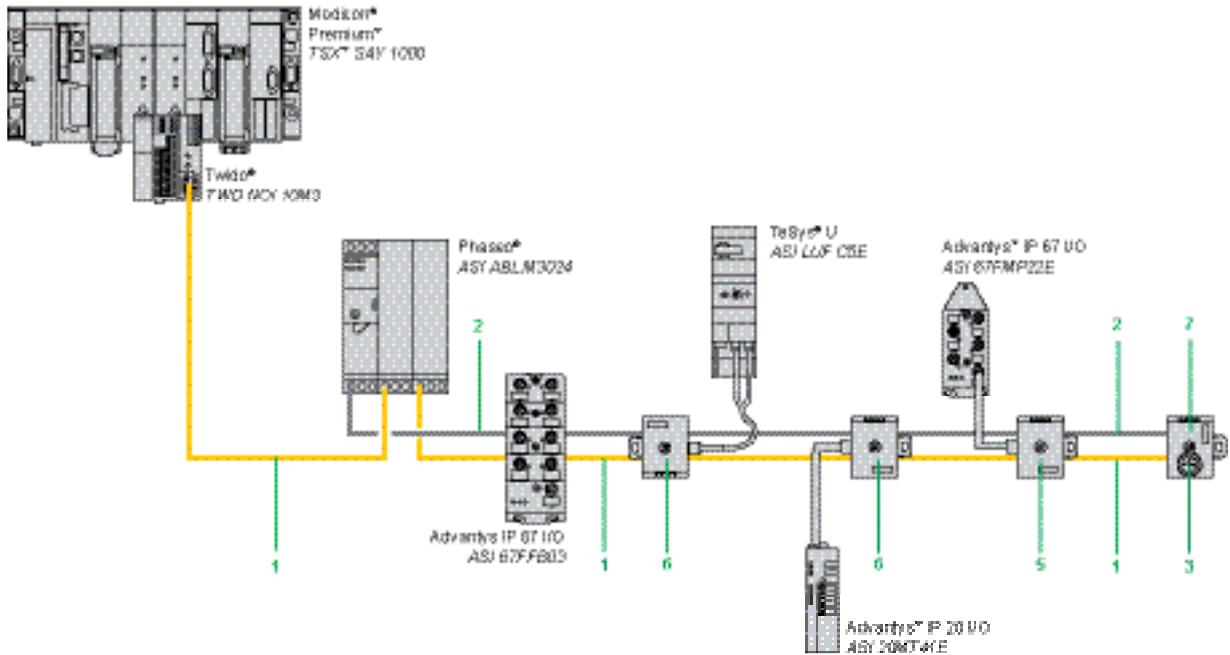

5

### Installation

#### AS-Interface cable lengths

We recommend use of the flat yellow cable. The maximum length of an AS-Interface segment is 100 m, which can be extended to:

- 200 m by using a repeater or a line extension:

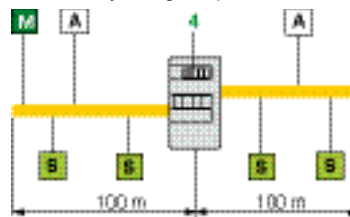

- 300 m with 2 repeaters.

- 500 m by placing the master in the center of the network:

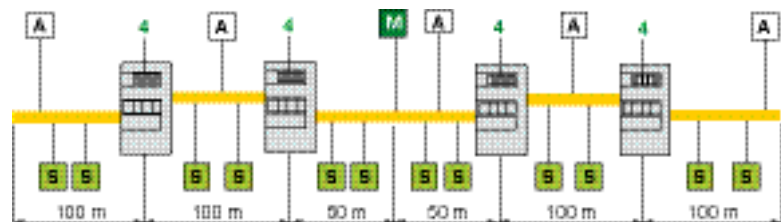

M = Master Module  
 A = Supply  
 S = Interface or component

**Note:** 300 m corresponds to the maximum distance between the master and the furthest slave.

For more information on the installation of AS-Interface, please refer to section 5 of our "Machines and Installations with Industrial Communications" catalog.



XZ CB1●●0●



TCS AAR011M



ASI RPT01



ASI 67FACC2



TCS ATN011F●



TCS ATV011F●



TCS ATN011F



TCS ATN02V

### Flat cables and line accessories

The special profile of these 2-core flat cables eliminates the risk of polarity reversal when connecting. Connections to the cables are made by IDCs (Insulation Displacement Connectors), see connection accessories.

The material used for the cable sheath causes the holes made by the IDCs to reseal themselves as soon as the connectors are removed, maintaining the IP 67 degree of protection of AS-Interface cabling accessories.

The ambient temperatures which AS-Interface® flat cable can withstand are as follows, according to the type of cable:

- Standard cable: 25...+ 85 °C for operation, - 40...+ 85 °C for storage.

- TPE cable (oil and vapour resistant): - 30...+ 105 °C for operation with cable flexing, - 40...+ 105 °C for non-flexing operation or storage.

Description	Sheath color	Rep.	Length	Type of cable	Reference	Weight kg
Flat cables 2 x 1.5 mm <sup>2</sup> Ue ≤ 48 V	Yellow (for AS-Interface)	1	20 m	Standard	XZ CB10201	1.400
				TPE	XZ CB10201H	1.400
			50 m	Standard	XZ CB10501	3.500
				TPE	XZ CB10501H	3.500
			100 m	Standard	XZ CB11001	7.000
				TPE	XZ CB11001H	7.000
	Black (for separate --- 24 V supply)	2	20 m	Standard	XZ CB10202	1.400
				TPE	XZ CB10202H	1.400
			50 m	Standard	XZ CB10502	3.500
				TPE	XZ CB10502H	3.500
			100 m	Standard	XZ CB11002	7.000
				TPE	XZ CB11002H	7.000

Description	Application	Rep.	Length	Order in multiples of	Unit reference	Weight kg
Line extension	Allows the length of a segment to be extended from 100 to 200 m	3	–	–	TCS AAR011M	0.047
Repeater	Enables an AS-Interface line to be extended by 100 m	4	–	–	ASI RPT01	0.190
Heat shrinkable cable end	To preserve IP 67 degree of protection at the end of the AS-Interface cable	–	–	10	ASI 67FACC2	0.002

### Accessories for connection to AS-Interface® flat cables

Degree of protection: IP 67, connection to flat cables by means of IDC's. Ue ≤ 40 V, Ie ≤ 2 A.

Ambient temperature: - 25 °C...+ 70 °C for operation, - 40...+ 85 °C for storage.

#### Tap-offs for connection of AS-Interface components

Description	Connection to the AS-Interface component	Rep.	Cable length	Fixing	Reference	Weight kg
Tap-offs for connection to a flat cable for AS-Interface (yellow)	Flying lead with 5-way, female, straight, M12 end connector. 2 x 0.34 mm <sup>2</sup> cable	–	1 m	Screw	TCS ATN011F1	0.090
			2 m	Screw	TCS ATN011F2	0.130
	Cable with stripped ends for terminal block. 2 x 0.34 mm <sup>2</sup> cable	–	2 m	Screw	TCS ATN01N2	0.215
Tap-offs for connection to two flat cables:	Flying lead with 5-way, female, straight, M12 end connector. 4 x 0.34 mm <sup>2</sup> cable	5	1 m	Screw	TCS ATV011F1	0.140
			2 m	Screw	TCS ATV011F2	0.180
- 1 for AS-Interface (yellow) - 1 for the separate supply (black)	Cable with stripped ends for terminal block. 4 x 0.34 mm <sup>2</sup> cable	6	2 m	Screw	TCS ATV01N2	0.265

#### T connectors

Description	Connection to the AS-Interface component	Rep.	Cable length	Fixing	Reference	Weight kg
T connector for connection to a flat cable for AS-Interface (yellow)	By 5-way female M12 connector	7	–	Screw	TCS ATN011F	0.026
Tap-off (or extension) for flat cables: 2 flat cables (yellow)	–	–	–	Screw	TCS ATN02V	0.019

### X-Way™ / OSI model

The communication architecture of the programmable TSX Micro™ and Premium™ PLCs, like that of TSX™ 17 or TSX™ model 40 PLCs, is compliant with the OSI model.

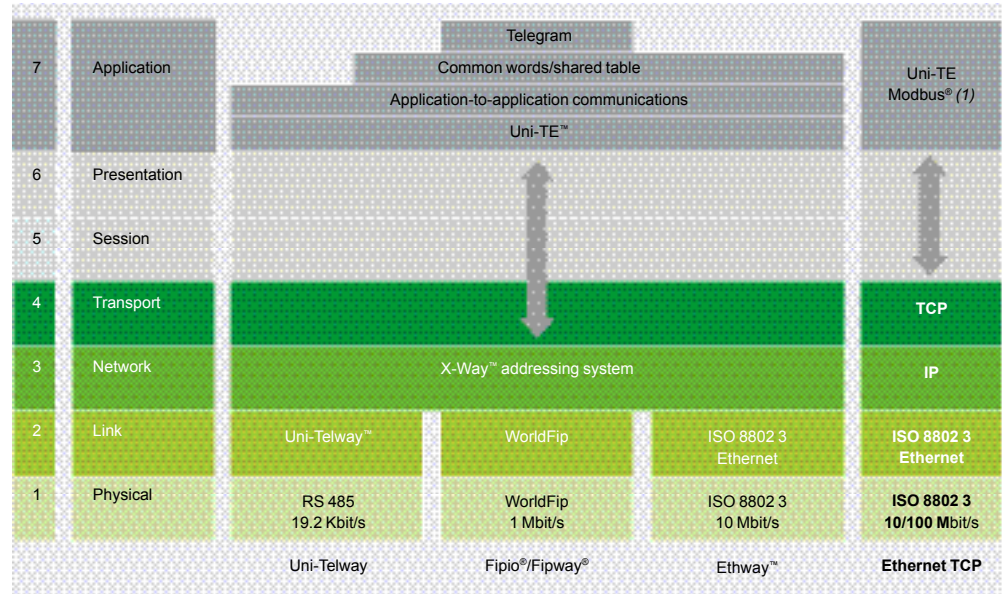

5

■ **The physical layer** enables the physical transmission of data signals between 2 systems via a medium.

In order for a network to operate correctly, and to help ensure full security of personnel in compliance with IEC 1131 2, it is necessary to follow the instructions provided in the manual “Grounding and Electromagnetic Compatibility of PLC Systems” included on DVD **UNY USE 909CDM** reference.

■ **The application layer** concerns application programs, data exchange and cooperation conventions.

This layer provides the following services:

- Industrial Uni-TE™ message, available on TSX Micro™/Premium™/TSX PLCs.
- Distributed COM database available on TSX Micro/Premium/TSX PLCs, or Shared Table service available on TSX Micro/Premium PLCs.
- Periodical data exchange on Fipio bus, see page 5/80
- Application-to-application communication.
- Telegram.

Size of requests	Ethway™, Ethernet TCP/IP (1)	Fipway®	Fipio®	Uni-Telway™
<b>Uni-TE™ service</b>	256 bytes (2)	128 bytes	128 bytes	240 bytes (3)
<b>COM service</b>	256 word database (4)	128 word database	–	–
<b>Application-to-application</b>	256 bytes	128 bytes	128 bytes	240 bytes (3)
<b>Telegram</b>	–	16 bytes	–	–

(1) Ethway not available on TSX Micro PLC.

(2) 1 K bytes with requests executed as a background task.

(3) 128 bytes on TSX Micro/Premium/TSX model 40 terminal port, 32 bytes on TSX 17 20 and TSX 47 20/25.

(4) COM service not available with Ethernet TCP/IP.

#### Uni-TE™ services

The Uni-TE protocol is the industrial message handling system supported by the X-Way™ communication architecture. It operates on the question/answer or request/confirmation principle. A device which supports the Uni-TE protocol can be a:

- **Client:** this device initiates communication. It asks a question (reads), transmits data (writes) or sends an instruction (Run, Stop, etc.).
- **Server:** this device executes the service requested by the client and sends a confirmation after execution.

The services provided depend on the type of device (PLC, numerical controller, programming terminal, supervision station, etc.). Depending on its function, each device can be Client and/or Server. A Client PLC can access other devices on the architecture via its application program: It can read/write objects on another PLC or numerical controller, select programs on a numerical controller, etc.

### Network transparency

When connected to any station in the network or directly connected to the Fipway®/ Ethernet TCP/IP network, a programming terminal can communicate with any other station in the network, as if the terminal were physically connected to the PLC. Network transparency also applies between stations connected to different segments of the same multinetwork architecture.

### COM service and Shared Table service (exclusive services one from another)

**The COM service** is made up of a set of dedicated words called common words. Each Fipway/Ethway™ network station may or may not access the database (in read only or read/write mode).

PLC stations exchanging common words (32 stations on Fipway, 64 stations on Ethway) are allocated, in a dedicated database (128 words for Fipway, 256 words for Ethway), a write zone (set at 4 words for the Fipway network, and variable from 4 to 64 words for the Ethway network) per TSX Micro™/Premium™ station.

COM words are updated automatically during each scan of the general sequential program (master task) without the intervention of the application program.

**The Shared Table service** can be used to exchange a table of internal words divided into as many zones as there are TSX Micro/Premium PLCs in the Fipway® network. The exchange principle is based on the broadcasting, by each PLC, of a word memory zone (broadcast zone) to the other PLCs on the network. Each network station is allocated an exchange table comprising 128 internal words for the 32 PLCs that share the service, with a broadcast zone assigned to each PLC, variable from 1 to 32 internal words.

### Application-to-application communication

This consists of using the user application program to send word tables between 2 devices, which may be TSX Micro/Premium and TSX PLCs.

This service is particularly suitable for:

- Sending alarm messages from a PLC to a supervision station.
- Exchanging data tables between two PLCs controlled by the application programs of the transmission and destination device.
- Sending broadcast messages to stations and devices.

### Telegram

The telegram service available on Fipway is a special case of application-to-application messages. It enables short messages to be sent and received on a priority basis (maximum 16 characters).

A telegram from a TSX Micro/Premium PLC is sent immediately without waiting for the end of the cycle. The telegram is received by the TSX Micro/Premium PLC in:

- The event-triggered task (processed as soon as the message arrives in the network card).
- The fast task or master task (when scanning the reception function).
- A PLC can only process one telegram at a time.

### Use in a multinetwork

The X-Way™ communication architecture is designed to cover multinetwork applications capable of dealing with problems of:

- Concentration, the architecture is particularly suitable for feedback of supervision data to a higher level.
- Redundancy, each PLC monitors the correct operation of both networks to which it is connected. If one of the networks does not respond, traffic could be transferred to the valid network.
- Inter-network communication. These architectures are comprised of several network segments which are interconnected by "bridge PLC" stations. Transparent communication is then offered between the entire architecture.

## Presentation

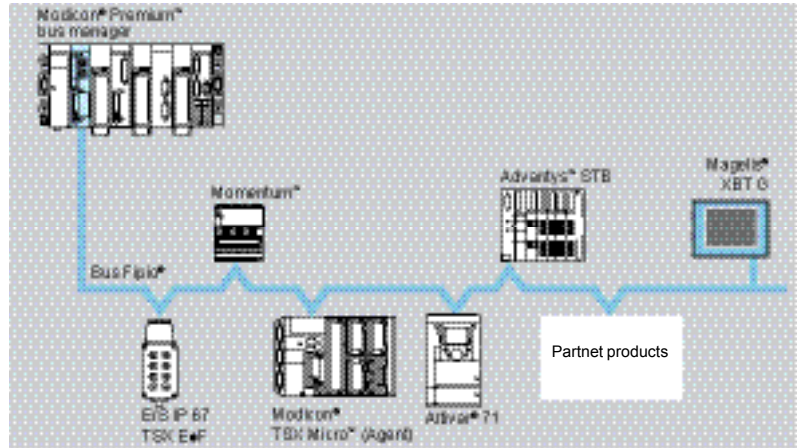

The Fipio® fieldbus is a standard means of communication between different control system components. It enables 127 devices to be connected at the connection point integrated in the processor. This fieldbus conforms to the WorldFip standard based on producer/consumer mechanisms. It is designed for remote location of I/O up to 15 km away and enables a third-party Schneider Alliances device to be installed.

The bus arbitrator (manager) can be a :

- Modicon® Premium™ PLC **TSX™ P 57 15●/25●/2823/35●/45●/4823/554M**

**Characteristics of Fipio bus**, see page 5/81.

**Fipio bus accessories** and connecting cables, see pages 5/86 to 5/89

## Connectable devices

Schneider Electric devices which can be connected on the Fipio bus include:

- Micro™/Premium™ PLCs Agent function via PCMCIA **TSX FPP 10** card
- Magelis® XBT GT/GK/GTW Advanced Panel, via **TSX CUSBFIP** USB/Fipio adaptor
- Magelis® Compact iPC/Smart BOX/Compact PC BOX/Flex PC BOX, via **TSX CUSBFIP** USB/Fipio adaptor
- Advantys™ STB distributed I/O with **STB NFP 2212** network interface module
- Momentum™ distributed discrete, analog or application-specific I/O with **170 FNT 110 01** communication
- Distributed discrete dust and damp proof I/O **TSX E•F** (IP 67).
- Altivar® 61/71 variable speed drive, via **VW3 A58301/311** card)
- PC terminal, via **TSX CUSBFIP** USB/Fipio adaptor
- TBX distributed discrete or analog I/O (IP 20) with TBX LEP 030 communication module (legacy range)
- Partner products of Collaborative Automation Partner program.

Find out more about the “Collaborative Automation Partner Program” at :

[www.collaborativeautomation.schneider-electric.com](http://www.collaborativeautomation.schneider-electric.com)

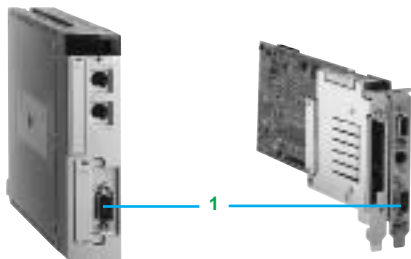

TSX P57 153M/154M

TPCX P57 354M

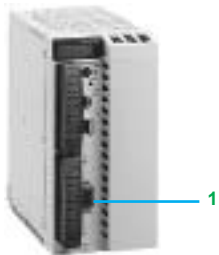

TSX P57 454/554M

## Description

TSX™ P57 ●53/54M processors and the TSX™ PCI 57 354M slot-PLC all have on the front panel:

- 1 9-way SUB-D connector, for connection to the bus via the TSX™ FP ACC2/12 connector.

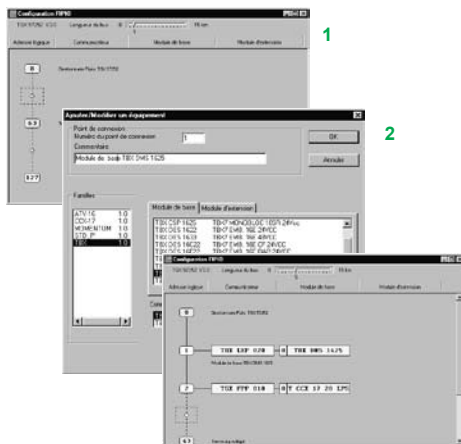

## Software setup

### Configuration

Unity™ Pro or PL7™ Junior/Pro software offer configuration screens that help to enable the declaration and intuitive configuration of the remote devices connected on the Fipio® bus.

- 1 Each circle represents one connection point.
- 2 Clicking on a circle accesses the catalog of devices which can be connected.
- 3 Once confirmed, the Fipio bus configuration will appear.

Processors fitted with the integrated Fipio link can manage 128 connection points on the bus (addresses 0 to 127).

See page 5/78 of this catalog for the table detailing limitations according to processor and type of device.

### Diagnostics

The diagnostic functions of the Fipio bus, integrated in the Unity Pro software or PL7 Junior/Pro software, very quickly identify detected faults on:

- The bus medium
- Remote devices.

- 1 A graphic representation of the architecture displays the defective devices in red.
- 2 More detailed diagnostics can be accessed by double-clicking.
- 3 In addition, special screens display an overview of the detected faults appearing on the bus or on any device. On request, these detected faults can be recorded for later analysis.

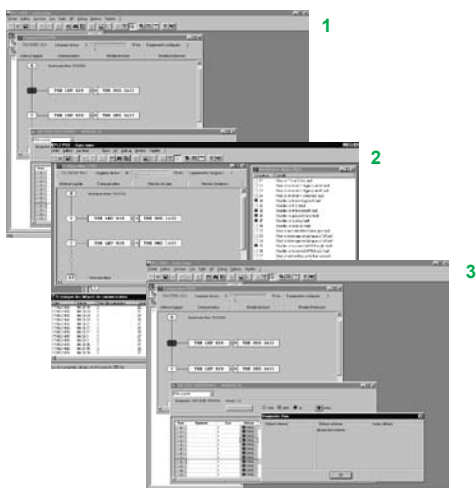

### Maximum configuration

The Fipio® bus enables a maximum of 128 devices to be connected. This number of devices can be limited depending on the type of bus manager processor and on the devices which are connected on the bus.

The maximum number of devices which can be connected depends on:

- The maximum size of memory space available for Fipio data which is
  - 94320 bytes for **TSX™ P57 15●/25●/2823/35●** processors and the **TSX™ PCI 57 354M** slot-PLC,
  - 214528 bytes for the **TSX P 57 45●/4823/554M**.
- The total number of bytes consumed by each device (see table below).

Product family	Reference	Base size (bytes)	Extension size (bytes)	Maximum number of connection points			
				TSX P57 1●	TSX P57 2●/ 3●	TSX P57 4●/ 5●	
<b>Maximum number of Fipio® devices (1)</b>							
Altivar® 61/71	With VW3 A3 311 card	1280		63	127	127	
Lexium® 15	With AM0 FIP 001V000 card	1424		62	62	62	
Magelis® iPC, compatible PC	With TSX CUSBFIP (address 63)	–		1	1	1	
Inductel, read/write stations	XGK-S130421, XGP-S1304202 With VW3 A58301 card	1808		52	52	62	
Advantys™ STB	STB NFP 2212	832, 896 or 1280 (2)		62	113, 105 or 73	126	
Momentum™	170 ADI ●●●/ADO ●●●, 170 ADM 350 10/11, 170 ARM 370 10/390 10/30, 170 ADM 690 51, 170 ARN 120 90, 170 ARM 370 30/390 10	832		62	98	98	
	170 AAI 030 00/520 40, 170 AAO 120 00/921 00, 170 AEC 920 00, 170 AMM 090 00	1808		52	52	98	
	170 AAI 140 00	2304		40	40	92	
TBX (3) <i>(legacy range)</i>	TBX AES 200/ASS 400 (4)	1332		62	70	126	
	TBX AMS 620	1584		272 (2/4 chan. extens.)	59	59	126
				272 (2 chan. extens.) 50 (4 chan. extens.)	50	50	100 (4) 84 (4)
				528 (8 chan. extens.)	44	44	63 (4)
	TBX CEP 1622/CSP 1622/1625	1152		31	31	31	
	TBX DES 16●●/DMS16●●/DSS16●●	1152		62	81	126	
	TBX DSS 1235	1152		144 (extension)	62	64 (5)	64 (5)
				144 (extension)	62	72	85 (5)
	TBX DMS 1025	1152		62	72	102 (5)	
	TBX EEP/ESP 08C22/1622 (IP 65)	1152		62	64	126	
TBX SAP 10	1808		52	52	117		
I/O IP 67	TSX EEF 08D2/EEF 16D2	832		62	98	98	
	TSX ESF 08T22/EMF 16DT2	1808		52	52	98	
Micro™/Premium™ Agent	With TSX FPP 10 card	1424		62	62	62	
FipConnect profile	FRD C2	832		62	113	126	
	FRD C2P	1744		54	54	122	
	FSD C8	896		62	105	126	
	FSD C8P	1808		52	52	117	
	FSD M8	1040		62	90	126	
	FSD M8P	1952		48	48	109	
	FED C32	1280		62	73	126	
	FED C32P	2304		40	40	92	
	FED M32	1424		62	66	126	
	FED M32P	2448		38	38	87	

Not applicable

(1) Address 63 is reserved for the programming and diagnostic terminal.

(2) Depending on the I/O number island.

(3) Do not mix discrete and analog base units on the same Fipio connection point.

(4) The number of analog channels for TBX base units (AES, ASS or AMS) is limited to 1008.

(5) The number of channels for TBX base units (DES, DMS or DSS) is limited to 2048.



### Application services

When using the bus manager function, the application services supported by the Modicon® Premium™ PLC are:

■ Remote I/O

Remote I/O modules are addressed by the PL7™ application program as “In rack” I/O, with which they can coexist. This service enables the exchange of I/O status variables and output command variables. These exchanges are carried out in a cyclical and deterministic manner and without intervention from the application program.

The manager also manages remote devices (configuration) in an aperiodic manner, without intervention from the application program.

■ Uni-TE™ service

X-Way™ industrial message handling service suitable for MMI, diagnostics and control functions (requests of 128 bytes maximum).

■ Application-to-application service

This service consists of sending tables between 2 devices under the control of their respective application programs (requests of 128 bytes maximum).

■ Terminal transparency

Terminals connected on a higher level X-way network or on the manager PLC terminal port communicate with the devices on the bus. This is also the case when the terminal is connected at the priority address 63.



TSX P57 153M



TSX P57 25M/35M/453M



TSX PCI 57 354M



TSX P57 454M/554M



TSX FPACC12

### Processors and coprocessor

#### Processors and slot-PLC with integrated Fipio® bus

Type and max.no. of racks	Software compatibility	Reference	Weight kg
TSX™ P57 15M 4 racks	Unity™ Pro	See page 1/12	–
	PL7™ Junior/Pro	See page 1/31	–
TSX P57 25M TSX P57 2823M 16 racks	Unity Pro	See page 1/12	–
	PL7 Junior/Pro	See page 1/31	–
TSX P57 35M 16 racks	Unity Pro	See page 1/12	–
	PL7 Junior/Pro	See page 1/31	–
TSX™ PCI 57 354M 16 racks	Unity Pro	See page 1/21	–
TSX P57 45M TSX P57 4823M 16 racks	Unity Pro	See page 1/13	–
	PL7 Junior/Pro	See page 1/31	–
TSX P57 554M 16 racks	Unity Pro	See page 1/13	–

#### Accessories and connecting cables (1)

Description	Use	Material	Reference	Weight kg
Female connectors 9-way SUB-D	Processors and slot-PLCs with Fipio integrated link	Polycarbonate black (IP 20)	TSX FP ACC12	0,040
		Zamac	TSX FP ACC2	0,080

(1) For other accessories and Fipio bus connecting cables, see pages 5/86 and 5/87

## Presentation

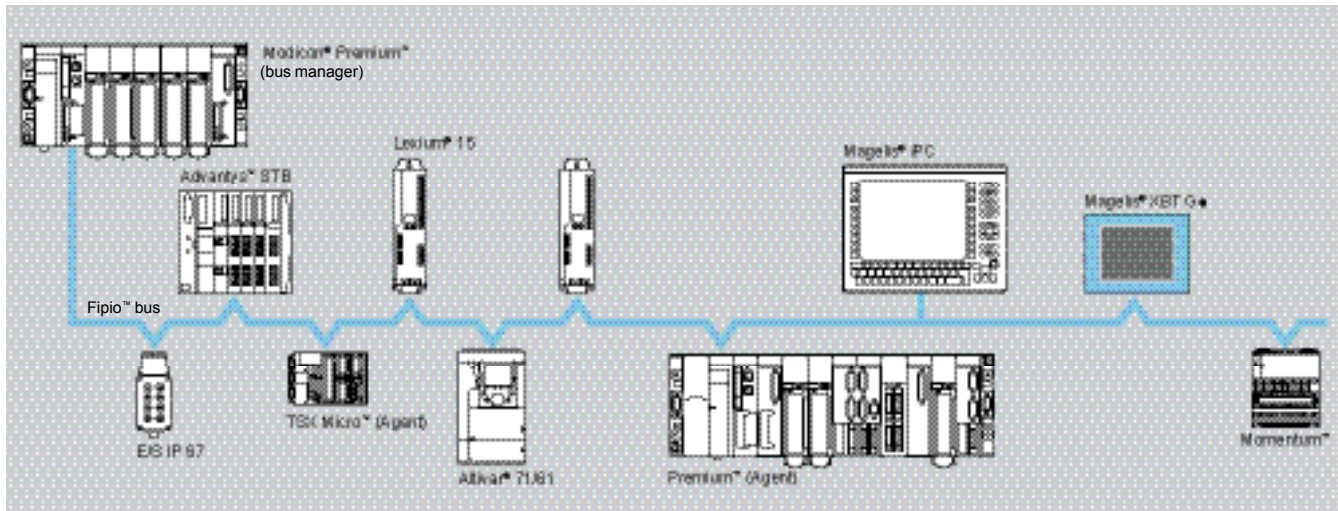

TSX Micro™ (TSX 37 21/22) or the Modicon® Premium™ PLC, fitted with a **TSX™ FPP10** PCMCIA card on their integrated communication channel, are agents on the Fipio® bus (with Fipio bus manager).

The Fipio bus enables I/O to be remotely located close to the devices to be controlled (TeSys®, Advantys™ STB, Momentum™, Altivar® and Lexium®).

The Agent function enables offline processing, by locating a TSX Micro PLC close to the machine.

In addition to the standard Fipio services (see pages 5/74 to 5/75), TSX Micro (TSX 37 21/22) and Premium PLCs allow exchanges of input and output variables with the bus manager PLC. These exchanges are performed cyclically, automatically and without the involvement of the application program at the same rate as the task for which the agent PLC has been configured.

**Fipio bus wiring system** and connection accessories, see pages 5/86 to 5/89.

## Application services

The application services supported by TSX Micro (TSX 37 21/22) and Premium Agent function PLCs are:

- Uni-TE™ service, X-Way™ industrial message handling service suitable for operator dialog, diagnostics and control functions (requests of up to 128 bytes).
- Application-to-application communication service, which consists of the transmission of tables between 2 devices controlled by their respective application programs (messages of up to 128 bytes).
- New periodic data exchange service for exchanging a 64 word table between the bus manager PLC and the Premium Agent PLC. Software setup see page 5/81.

## Description

TSX Micro (TSX 37 21/22)/Premium PLCs have a slot in the processor for a type III PCMCIA communication card. This can be fitted with a **TSX FPP10** Fipio bus connection card. The **TSX FPP10** card is comprised of:

- 1 A protective cover.
- 2 A removable cover with fixing screws giving access to the 20 way miniature connector.
- 3 Two indicator lamps:
  - ERR lamp: detected card or link fault,
  - COM lamp: transmission or reception of data.

**Connector to be ordered separately:**

- 4 **TSX FP CG010/030**, 1 or 3 m cable for connecting the **TSX FP ACC4** tap junction (on 9-way SUB-D connector).

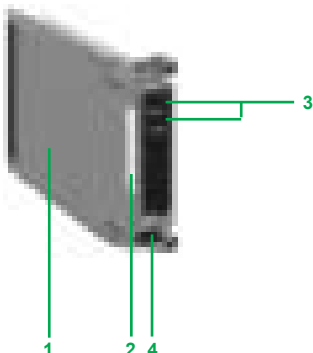

### Characteristics

The Fipio® industrial fieldbus is standard of communication between various control system components. It conforms to the WorldFip standard.

Type of Bus/network			Bus Fipio
<b>Structure</b>	Type		Open industrial fieldbus conforming to WordFip standard
	Topology		Devices linked by daisy-chaining or tap link connections
	Maximum length	m	15 000
	Access method		Producer/consumer principal Management by fixed arbitrator
<b>Transmission</b>	Mode		Physical layer in baseband on shielded twisted pair, conforming to NF C 46 604
	Data rate	Mbit/s	1
	Medium		150 □ shielded twisted pair, 62.5/125 or 50/125 fiber-optic using electrical/fiber-optic repeaters
<b>Configuration</b>	Number of devices	Per segment	32 connection points per segment
		Maxi	128 on all segments
	Segments	Number	Unlimited
		Length	m
<b>Services</b>	Input/output exchanges		Periodic and deterministic exchanges of variables between bus manager PLC and Agent PLC (64 %MWi consecutive words: 32 %MWi for transmission and 32 %MWi for reception)
	Uni-TE™		Point-to-point requests with confirmation report: 128 bytes maximum, can be used by devices connected to the same X-Way™ architecture (access by the Client device to the Server device system functions)
	Application-to-application		Point-to-point messages: 128 bytes maximum between 2 devices, can be used by TSX Micro(1)/Premium/TSX Series 7
	Security		Control characters in each frame and acknowledgement of point-to-point messages conforming to standard NF C46-603

(1) TSX Micro TSX 37 21/22 PLC only.



### Software setup

Each TSX Micro™ and Premium™ PLC Fipio® Agent uses 64 %MWi consecutive internal words to exchange periodic data. The first 32 words are reserved for sending data to the manager, and the remaining 32 are reserved for receiving data from the manager.

Unity™ Pro or PL7™ Micro/Junior/Pro application-specific screens allow the configuration of the Fipio Agent PCMCIA card. This consists of indicating the:

- connection point number (1 to 127).
- address at the beginning of the 64 %MW word table reserved for sending data to and receiving data from the manager.

### References

#### Fipio® bus connection component

Description	Composition	Use on	Reference	Weight kg
<b>Fipio Agent function</b> card	1 type III PCMCIA Version V1.8	TSX Micro processors	<b>TSX FPP10</b>	0,110

#### Connection wires to the Fipio bus (1)

Description	Use from	to	Length	Reference	Weight kg
Cordsets for PCMCIA card	TSX FPP10 card (miniature connector)	TSX FPACC3/4 connection box	1 m	<b>TSX FP CG010</b>	0,210
		(9-way SUB-D connector)	3 m	<b>TSX FP CG030</b>	0,310

(1) For other Fipio bus accessories and connection cables, see page 5/86 and 5/87



TSX FPP10



TSX FP CG010/030

## Presentation

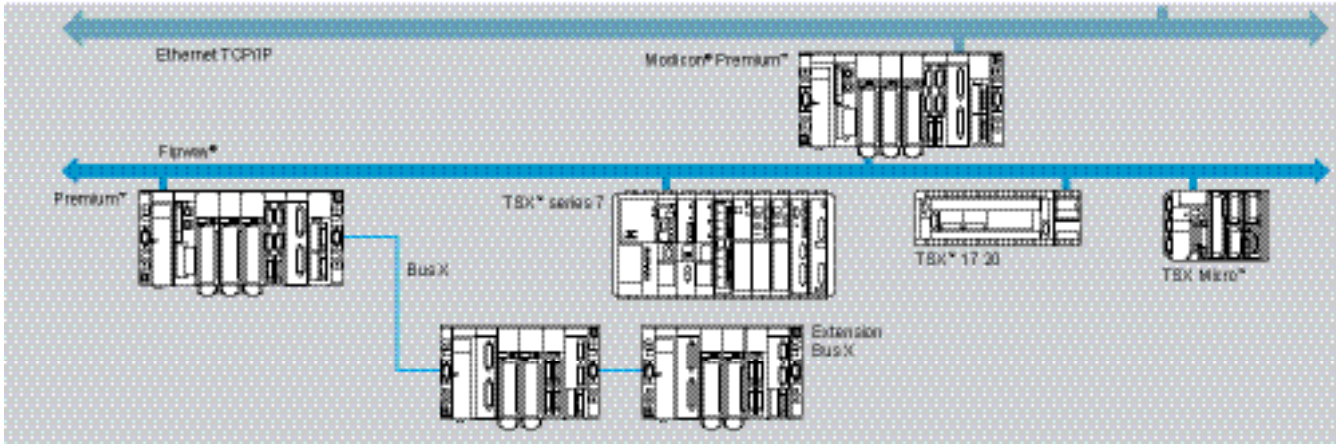

The Fipway® network is an open local area network for communication between the various TSX Micro™, Modicon® Premium™ and TSX™ Series 7 PLCs using X-Way™ services. Communication conforms to the FIP standard with access via a bus arbitrator.

TSX Micro (TSX 37 21/22) and Premium PLCs can be connected to a Fipway network using a Fipway PCMCIA card inserted in each processor or into the **TSX SCY 21601** (Premium) communication module. Supported X-Way™ services (see pages 5/75 to 5/75) are:

- Uni-TE™ services
- Distributed database (COM) or Shared Table
- Telegram (service only available when the PCMCIA card is inserted in the processor)
- Application-to-application communication.

Fipway network wiring and connection accessories, see pages 5/86 to 5/89.

## Performance

The operating principle of a Fipway network provides constant network cycle times whatever the traffic and number of stations (2 to 64). This enables the Fipway network to be updated (addition or removal of stations) without affecting its performance.

Maximum transmission time

- Telegram (TLG): priority application messages are transmitted in less than 10 ms (one telegram per station).
- Common words (COM): the database of common words is updated every 40 ms.
- Shared Table: the exchange table is updated every 40 ms.

Uni-TE™ message handling system: Uni-TE or standard application-to-application messages are normally transmitted in less than 80 ms (40 ms for stations with addresses below 32). Where there is a large amount of traffic, some messages can wait for several cycles before being transmitted. The network characteristics enable a maximum of 210 messages of 128 bytes per second to be transmitted.

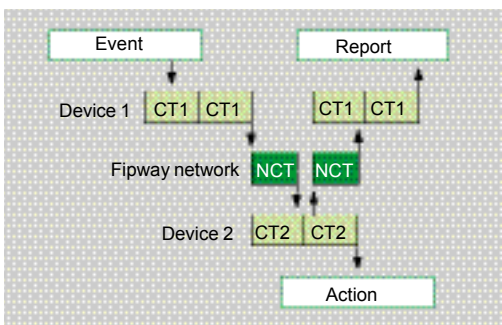

The performance can be improved by inhibiting the Telegram service in the network. With such network characteristics, the response time at application level depends almost exclusively on the processing capacity of the devices which are connected. For example, the remote loading of a 50 K word program takes less than two minutes on a network with normal load.

CT1 = Cycle time of device 1.  
NCT = Cycle time of Fipway network.  
CT2 = Cycle time of device 2.

The response time must be evaluated by the designer of each application in relation to the devices connected. The processing time of a device can vary from one to two cycle times as a function of asynchronous operation.

Characteristics			
Type of bus/network		Fipway® network	
<b>Structure</b>	Type	Open industrial fieldbus conforming to WordFip standard	
	Topology	Devices linked by daisy-chaining or tap link connections	
	Maximum length	<b>m</b>	5 000
	Access method	Producer/consumer principal Management by fixed arbitrator	
<b>Transmission</b>	Mode	Physical layer in baseband on shielded twisted pair, conforming to NF C46-604	
	Data rate	<b>Mbit/s</b>	1
	Medium	150 □ shielded twisted pair, 62.5/125 or 50/125 fiber-optic using electrical/fiber-optic repeaters	
<b>Configuration</b>	Number of devices	Per segment	32 stations
		Maxi	64 stations
	Segments	Number	Unlimited
		Length	<b>m</b>
<b>Services</b>	COM (1)	Distributed database: 128 mots maximum 0 or 4 % NWi words for TSX Micro™ and Premium™ station with addresses 0 to 31	
	Shared table (1)	Shared table of internal words: 128 words maximum 1 to 32 % MWi words per TSX Micro and Premium station with addresses 0 to 3 (2)	
	Uni-TE™	Point-to-point requests with confirmation report: 128 bytes maximum, can be used by devices connected to the same X-Way™ architecture (access by the Client device to the Server device system functions)	
	Application-to-application	Point-to-point messages: 128 bytes maximum between 2 devices, can be used by TSX Micro (1)/Premium/TSX™ Series 7	
	Telegram	Point-to-point priority messages: 16 bytes maximum between 2 Premium (3) or TSX Series 7 stations with addresses 0 to 15	
	Security	Control characters in each frame and acknowledgement of point-to-point messages conforming to standard NF C46-603	

(1) The COM and Shared table service are mutually exclusive.

(2) Service reserved for TSX Micro and Premium PLCs.

(3) Service only available when Fipway PCMCIA card is installed in the processor.

### Description

TSX Micro™/Premium™ PLCs have a slot on the processor for a type III PCMCIA communication card. This can be fitted with the **TSX™ FPP20** fipway network connection card, which is also inserted into the **TSX™ SCY 21601** communication module slot. This FPP20 connection card is similar to the TSX(TM) FFP10 card, found on page 5/80.

### References

Description	Number per Premium PLC	Use on	Weight kg
<b>Fipway® card</b> (1)	1 with TSX 37 20 TSX 57 10/20 3 with TSX 57 30 4 with 57 40/50/60	TSX Micro™ Premium™ PLC TSX SCY 21601 module	<b>TSX™ FPP20</b> 0.110
<b>Communication module</b> 2 channels	See page 5/105	For Premium PLC - 1 isolated 2 wire RS 485 integrated channel (Half-duplex) - 1 slot for type III PCMCIA card	<b>TSX™ SCY 21601</b> 0.360
<b>Set of X-Way™ drivers for PC compatible</b>	Includes the X-Way drivers on one CD-ROM		See page 6/77

### Fipway connection cables and accessories (2)

Description	Use From	To	Length	Reference	Weight kg
<b>Cables for PCMCIA</b>	TSX FPP20 card (miniature connector)	TSX FP ACC3/4	1 m	<b>TSX™ FP CG 010</b>	0.210
		box (9-way SUB-D connector)	3 m	<b>TSX FP CG 030</b>	0.410

(1) The **TSX P57 4634M/5634M/6634M** Unity processors Unity with integrated Ethernet port do not support the Fipway **TSX FPP20** card in the PCMCIA slot.

(2) For other network accessories and connection cables, see pages 5/88 and 5/89.



TSX FPP20



TSX SCY 21601



TSX FP CG010/030

# Modicon® Premium™ automation platform

## Fipio®/Fipway® optic transceiver

### Presentation

The **OZD FIP G3** optic transceivers are particularly adapted for use with applications which are subject to harsh electrical environments or which are distributed over large areas:

- Public buildings.
- Large-scale industrial sites.
- Water treatment and distribution.
- Transport and highway tunnel infrastructures, etc.

The **OZD FIP G3** optic transceiver enables conversion of a FIP electric interface to 2 FIP optic interfaces and vice versa. As a result, it allows redundant ring topologies to exist; these improve installation availability even when a line is broken at a point in the medium.

In these situations, the length of the bus or the Fipio/Fipway ring can reach:

- 20 km, with a max. 32 transceivers on Fipio®
- 20 km, with a max. 20 transceivers Fipway®

See characteristics on page 5/85 of this catalog.

These characteristics may be enhanced using mixed topologies such as 2 serial optic rings or 2 serial optic buses; please consult our regional office.

### Wiring system

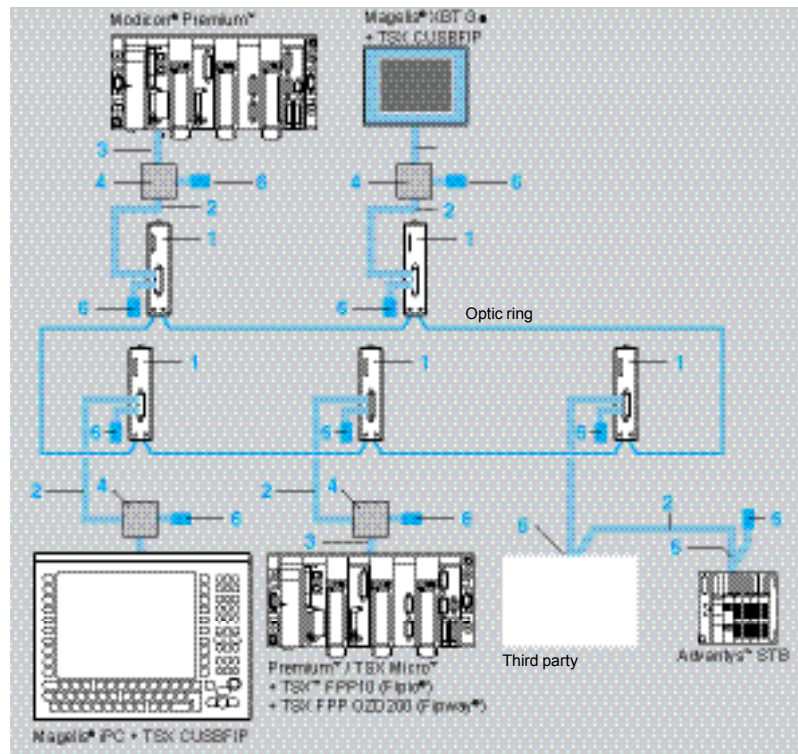

- 1 **OZD FIP GG3**: Fipio®/Fipway® optic transceiver.
- 2 **TSX™ FP CA●00**: 150 Ω shielded twisted pair trunk cable (Ø 8 mm) for use in standard environments and inside buildings (1).
- 3 **TSX FP CG 0●0**: tap-off connection cable for **TSX FPP10/OZD200** PCMCIA card for TSX Micro™/Premium™ PLCs.
- 4 **TSX FP ACC3/4**: T-junction box. It also has two 9-way female SUB-D connectors for connecting any device which connects to the bus by a PCMCIA card.
- 5 **TSX FP ACC2/12**: 9-way female SUB-D connector for Fipway/Fipio connection using daisy chaining or tap link connection.
- 6 **TSX FP ACC7**: line terminator to be placed at each segment end.  
TSX LES 65: terminal block for TSX™ Series 7 PLC, which performs the address coding.

(1) Trunk cable TSX FP CR●00 for use in harsh environment and outside building, see page 5/89

### Operating mode and performances

#### ■ Fipio® bus on fiber-optic

After configuration in Fipio mode, the processor scans the various application devices according to the software configuration:

- Image variables of the input values and of the output command values of a configured device are scanned as quickly as possible on the bus, whilst respecting the existing relationships between periods of different tasks which use these devices.
- Appearance or disappearance of a configured device is detected on the bus within a maximum time of 200 ms.
- Exchanges occur at the rate defined by the programmer, from 10 to 20 Uni-TE™ messages per second.

The network cycle time is double that of the electrical bus when OZD FIP G3 transceivers are used.

#### ■ Fipway bus on fiber-optic

The operating principle is identical to that on an electrical network, in that the number of stations is limited to 32 and the transmission time is as follows:

- For the Common words and Shared Table services, updating of the entire database is carried out every 40 ms maximum.
- For Uni-TE™ message handling, the network characteristics are used to transmit a maximum of 230 messages of 128 bytes per second.

### Characteristics (with OZD FIP G3 optic transceivers) (1)

Type of bus/network	Fipio® bus	Fipway® network
<b>Structure</b>	Type	Open industrial support conforming to Fip standard
	Topology	In redundant rings or in a line with simple redundant links
	Access method	Producer/consumer principle Management by a fixed arbitrator
<b>Transmission</b>	Mode	Multimode (860 nanometers)
	Data rate	1 Mbit/s
	Medium (2)	Fiber-optic 50/125 - 17 dBm or 62.5/125 - 15 dBm
	Inter-repeater distance	2,500 m for 50/125 and 2,800 m for 62.5/125
<b>Configuration</b>	No. of connection points	32 optic transceivers
	Maximum no. of devices	16 Fipio devices can be connected to the same fiber-optic transceiver
	No. of segments	The loop (or fiber-optic line) is similar to a non cascable segment
	Length	Maximum circumference of the ring (or length of the line): 20 km
	Maximum optic distance between 2 OZD FIP G3 transceivers	1,500 m, with the following on the ring or the line: 32 optic transceivers 2,000 m, with the following on the ring or the line: < 32 optic transceivers 3,000 m, with the following on the ring or the line: 2 optic transceivers
	Tap links	From the OZD FIP G3 fiber-optic transceiver, the maximum length of the electrical tap link is 100 m
<b>Services</b>	Same as page 5/74 except for the Telegram service, which is not available with OZD FIP G3 fiber-optic transceiver	

### References

Description	Max. number of transceivers	Fipio bus Connectable devices	Fipway network	Reference	Weight kg
<b>Optic transceiver Fipio/Fipway (3)</b>	32 with Fipio® 20 with Fipway®	- TSX Micro/Premium - Advantys™ STB distributed I/O - Momentum™ distributed I/O - Magelis® XBT G● terminal - Magelis® iPC industrial PCs - Altivar® 71/61 speed drives - Lexium® 15 servo drives, etc.	TSX Micro™, Premium™	<b>OZD FIP G3</b>	0.500
<b>TSX Micro/Premium PLC connection components (4)</b>					
Description	Use	Composition	Reference	Weight kg	
<b>Fipway card</b>	TSX™ 37 21/22 Micro PLC, Premium processor	1 type III PCMCIA card	<b>TSX™ FPP OZD200</b>	0.110	
<b>Fipio card agent function</b>	TSX 37 21/22 Micro PLC, Premium processor	1 type III PCMCIA card	<b>TSX™ FPP10</b>	0.110	



OZD FIP G3



TSX FPP 20/10

(1) These characteristics can be increased using mixed topologies; please consult our regional office.

(2) Devices connected on electrical tap links are compatible with the WorldFip physical layer.

(3) For TSX FP ACC8M fiber-optic electrical repeater, see page 5/88

(4) For accessories and connection cables, see pages 5/88 and 5/89

### Fipio® bus and Fipway® network wiring system

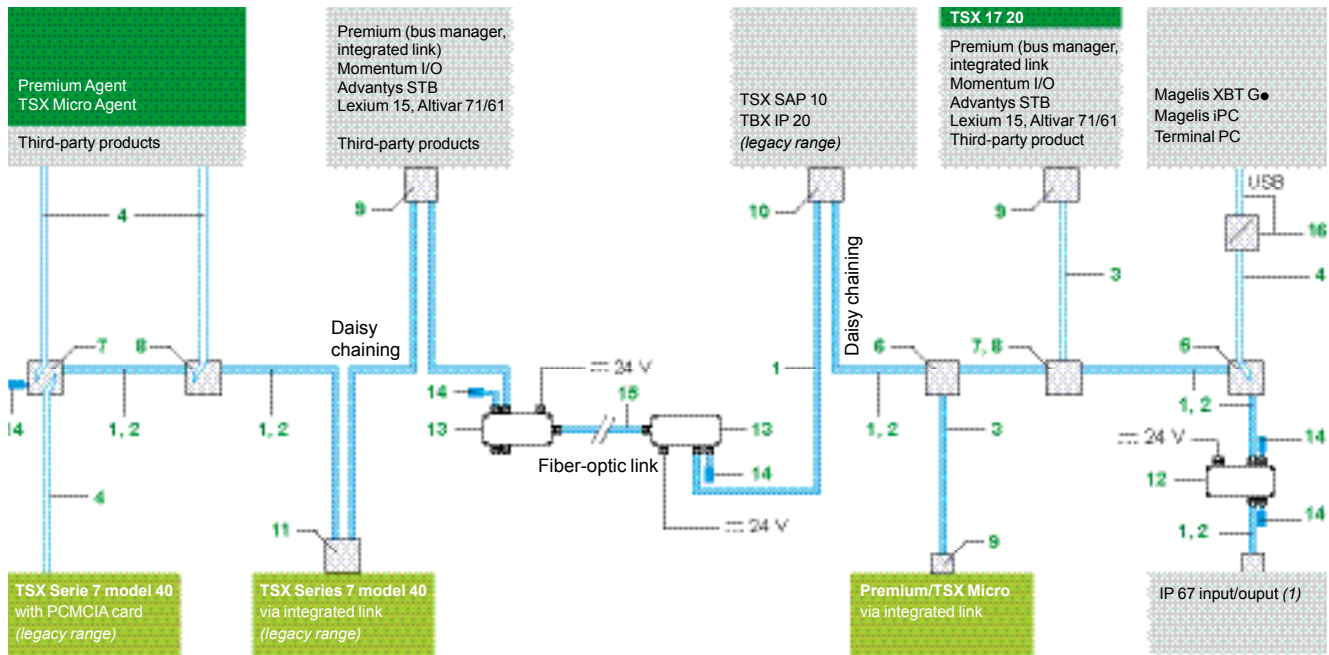

**F** Connection to Fipway network and Fipio bus       Connection to Fipway network       Connection to Fipio bus

(1) IP 67 I/O modules on Fipio bus: TSX EEF/ESF/EMF modules and connections, see pages 3/32 to 3/41.

### Connectable devices

Devices to be connected on Fipio	Boxes				Connectors			
	TSX™ FP ACC4 8	TSX FP ACC14 6	TSX FP ACC3 7	TSX™ EF ACC99	TSX FP ACC 2 9	TSX FP ACC12 9	TBX BLP01 10	TBX BAS10
Premium™ bus manager	D	D			C/D	C/D		
Premium Fipio® Agent (PCMCIA)	D		D					
TSX Micro™ Fipio Agent (PCMCIA)	D		D					
Lexium® 15 servo drives	D		D		C/D	C/D		
Altivar® 71/61 variable speed drives	D		D			C/D		
USB/FIP adapter 15	D		D					
Advantys™ STB/Momentum™	D	D			C/D	C/D		
TBX™ IP 20 I/O (legacy range)	D	D					C/D	
IP 67 I/O				C/D				
Devices to be connected on Fipway	Boxes				Connectors			
	TSX FP ACC4 8	TSX FP ACC14 6	TSX FP ACC3 7	TSX EF ACC99	TSX FP ACC 2 9	TSX FP ACC12 9	TBX BLP10	TBX BAS10
Premium (PCMCIA)	D		D					
TSX Micro (PCMCIA)	D		D					
TSX 7™ model 40 (integrated link)	D	D						C/D
TSX 7 model 40 (PCMCIA)	D		D					
USB/FIP adapter 15	D		D					
LUF P1 Modbus gateway	D		D		C/D	C/D		

Recommended connection      **C:** connection by daisy chaining  
 Possible connection      **D:** connection by tap link



### Cables

- 1 TSX™ FP CA●00: trunk cable, shielded twisted pair 150 □ (Ø 8 mm) for normal environments and use inside buildings.
- 2 TSX FP CR●00: trunk cable, shielded twisted pair 150 □ (Ø 9.5 mm) for harsh environments and use outside buildings.  
TSX FP CP●00: trunk cable, shielded twisted pair 150 □ and 1 x 1.5 mm<sup>2</sup> pair for remote supply (Ø 9.5 mm) for harsh environments and use outside buildings.
- 3 TSX FP CC●00: tap link cable, shielded twisted pair 150 □ (Ø 8 mm) for normal environments and use inside buildings.
- 4 TSX FP CG0●0: cordset for PCMCIA **TSX FPP10/20/OZD200** communication card for TSX Micro™/Premium™/TSX Series 7 PLCs or **TSX CUSBFIP** USB/FIP adapter. Connection to the bus is via a 9-way SUB-D connector on the **TSX FP ACC3/ACC4** junction box.

### Connection boxes

- 6 TSX FP ACC14: Polycarbonate IP 20 junction box: provides tap link from the trunk cable to connect 1 device via **TSX FP CC●00** tap link cable or several devices in a daisy chain.
- 7 TSX FP ACC3: IP 20 box for connecting 2 **TSX FPP10/20/OZD200** PCMCIA cards or **TSX CUSBFIP** USB/FIP adapter on a 9-way SUB-D connector.
- 8 TSX FP ACC4: IP 65 junction box. It also has a 9-way female SUB-D connector for the **TSX FPP10/20/OZD200** PCMCIA card or **TSX CUSBFIP** USB/FIP adapter (in this case, the box is IP 20).

**TSX EF ACC99**: IP 65 junction box for IP 67 I/O modules, see page 3/39.

### Connectors

- 9 TSX FP ACC2 and TSX FP ACC12: 9-way female SUB-D connector for Fipway®/Fipio® connection (TSX FP ACC2 connector dedicated to TSX 17 20 micro-PLC). Used for daisy chain or tap link connection (90° output high or low, 45° output high or low).
- 10 TBX BLP01: connector for TBX IP 20 I/O modules (*legacy range*).
- 11 TSX LES65: connecting cable for TSX/PMX model 40 PLCs (*legacy range*). Used for address coding.
- 12 TSX FP ACC6: electrical repeater: used to increase the number of stations (max 64) and the length of the network by creating an additional segment of up to 1000 m (a maximum of 4 repeaters in cascade giving a network length of 5000 m).

TSX™ EF C●●●: dust and damp proof connectors for IP 67 I/O modules, see page 3/39.

### Other elements







- 13 TSX FP ACC8M: fiber-optic/electrical repeater: used to connect electrical segments via a fiber-optic link (particularly suitable for zones with a high level of interference) or to connect a fiber-optic device.
- 14 TSX FP ACC7: Line terminator, to be installed at both ends of a segment.
- 15 **TSX™ CUSBFIP**: USB/Fipio-Fipway adapter for connecting any device with USB port (Magelis® XBT G●, PC terminal, Magelis® iPC industrial PC).

TSX FP JF020: fiber-optic jumper (length 2 m). For fiber-optic connection of the **TSX FP ACC8M** repeater to a patch panel. The maximum length of the fiber-optic cable (62.5/125) between 2 repeaters is 3000 m.

TSX EF ACC7: line terminator, to be installed at both ends of a segment requiring IP 67 protection, see page 3/39.

TSX FP ACC9: network wiring test tool. This is used for testing the continuity of segments, the connections of the various devices and the installation of line terminators.

### Fipio® bus/Fipway® network connection accessories (1)

	Description	Use	Rep.	Reference	Weight kg
 TSX FP ACC14	<b>Insulated bus connection box</b> (black polycarbonate, IP 20)	Trunk cable tap link (for connecting the --- 24 V power supply of TBX IP 67 modules)	6	TSX™ FP ACC14	0.120
		Trunk cable tap link supports 2 x 9-way SUB-D female connectors (for PCMCIA card cable TSX FP CG010/030) For connecting --- 24 V power supply of TBX dust and damp proof modules	7	TSX FP ACC3	0.090
 TSX FP ACC3	<b>Dust and damp proof bus connection box</b> (Zamac material, IP 65)	Trunk cable tap link, supports 1 x 9-way female SUB-D connector (for PCMCIA card cable TSX FP CG010/030)	8	TSX FP ACC4	0.660
		Trunk cable tap link via 2 M23 connectors Remote --- 24 V power distribution via 7/8" connector PC terminal connection via 9-way female SUB-D connector	–	TSX™ EF ACC99	0.715
 TSX FP ACC4	<b>Female connector</b> for devices with 9-way SUB-D connector	Black polycarbonate material IP 20 Connection by daisy chaining or tap link	9	TSX FP ACC12	0.040
		Zamac material, dedicated TSX 17 20 PLC ( <i>legacy range</i> ) Connection by daisy chaining	9	TSX FP ACC2	0.080
	<b>Line terminators</b>	2 impedance adaptors Sold in lots of 2	14	TSX EF ACC7	0.020
 TSX EF ACC99	<b>Electrical repeater</b> (IP 65)	Increases the length of the network or bus by allowing the connection of 2 segments of up to 1000 m each	12	TSX FP ACC6	0.520
		<b>Electrical/fiber-optic repeater</b> (IP 65)	Used to connect (via patch panel) an electrical segment (1000 m max.) and a fiber-optic segment (3000 m max.)	13	TSX FP ACC8M
 TSX FP ACC12	<b>FIP wiring test tool</b>	Used to test each cable segment of the network	–	TSX FP ACC9	0.050
<b>Fipio/Fipway communication cards and USB adapter</b>					
	<b>PCMCIA cards</b>	Type III cards for Premium/TSX Micro PLCs	–	See pages 5/83 and 5/81	
 TSX FP ACC12	<b>USB/Fipio-Fipway adapter</b>	Allows to connect to Fipio® bus or a Fipway® network any device with a standard USB port. Included the USB cordset (length 2 m) Requires the TSX CG010/030 4 to connect to TSX FP ACC3/ACC4 box	15	TSX™ C USBFIP	0.140

(1) The characteristics and performances of the Fipio bus or Fipway network are dependent on the above TSX FP accessories being used.

### Fipway® network/Fipio® bus connecting cables (1)

Description	Type	Conditions of use	Rep.	Length	Reference	Weight kg
<b>Trunk cables</b>	Ø 8 mm, 1 shielded twisted pair 150 □	In normal environment (2) Inside building	1	100 m	<b>TSX™ FP CA100</b>	5.680
				200 m	<b>TSX FP CA200</b>	10.920
				500 m	<b>TSX FP CA500</b>	30.000
	Ø 9.5 mm, 1 shielded twisted pair 150 □	In harsh environment (3) Outside building In garland (4)	2	100 m	<b>TSX FP CR100</b>	7.680
				200 m	<b>TSX FP CR200</b>	14.920
				500 m	<b>TSX FP CR500</b>	30.000
	Ø 9.5 mm, 1 shielded twisted pair 150 □ and 1 x 1.5 mm² pair for 24 V remote supply	In harsh environment (3) Outside building In garland (4)	-	100 m	<b>TSX FP CP100</b>	7.680
				500 m	<b>TSX FP CP500</b>	30.000
	<b>Tap link cables</b>	Ø 8 mm, 2 shielded twisted pairs 150 □	In normal environment (2) Inside building	a	100 m	<b>TSX FP CC100</b>
200 m					<b>TSX FP CC200</b>	10.920
500 m					<b>TSX FP CC500</b>	30.000
<b>Cordsets for TSX FPP PCMCIA card USB/FIP adapter</b>	With 1 miniature connector and 1 9-way SUB-D connector	In normal environment (2) Inside building	4	1 m	<b>TSX FP CG010</b>	0.210
				3 m	<b>TSX FP CG030</b>	0.310
<b>Fiber-optic jumper</b>	Double fiber-optic 62.5/125 µm	For electrical/fiber-optic repeater	15	2 m	<b>TSX FP JF020</b>	0.550



TSX FP CG010

(1) The characteristics and performances of the Fipio bus/Fipway network are dependent on the above TSX FP accessories being used.

(2) Normal environment:

- without special environmental restrictions,
- operating temperature between + 5 °C and + 60 °C,
- fixed installations.

(3) Harsh environment:

- resistance to hydrocarbons, industrial oils, detergents, solder chips,
- up to 100% humidity,
- saline environment,
- extreme variations in temperature,
- operating temperature between - 10 °C and + 70 °C,
- mobile installations.

(4) Mobile installations: cables as per VDE 472, part 603/H:

- for use on cable drag chain with minimum bend radius of 75 mm,
- for use on gantry crane (strickthrough: portal support), subject to compliance with conditions for use such as acceleration, speed, length etc: contact our regional branch office for further information.
- not authorized for use on robots, or multi-axis applications.

### Dimensions

TSX™ FP ACC4

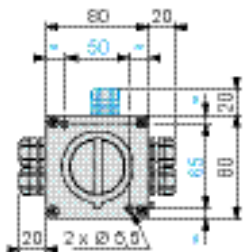

TSX FP ACC6

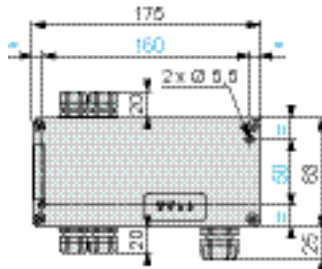

TSX FP ACC8M

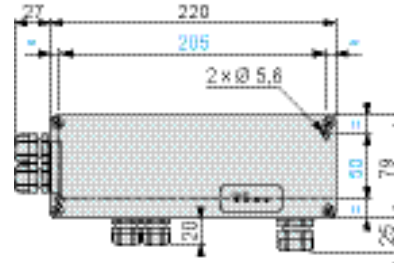

TSX FP ACC14

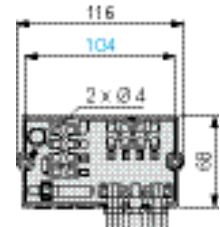

Presentation

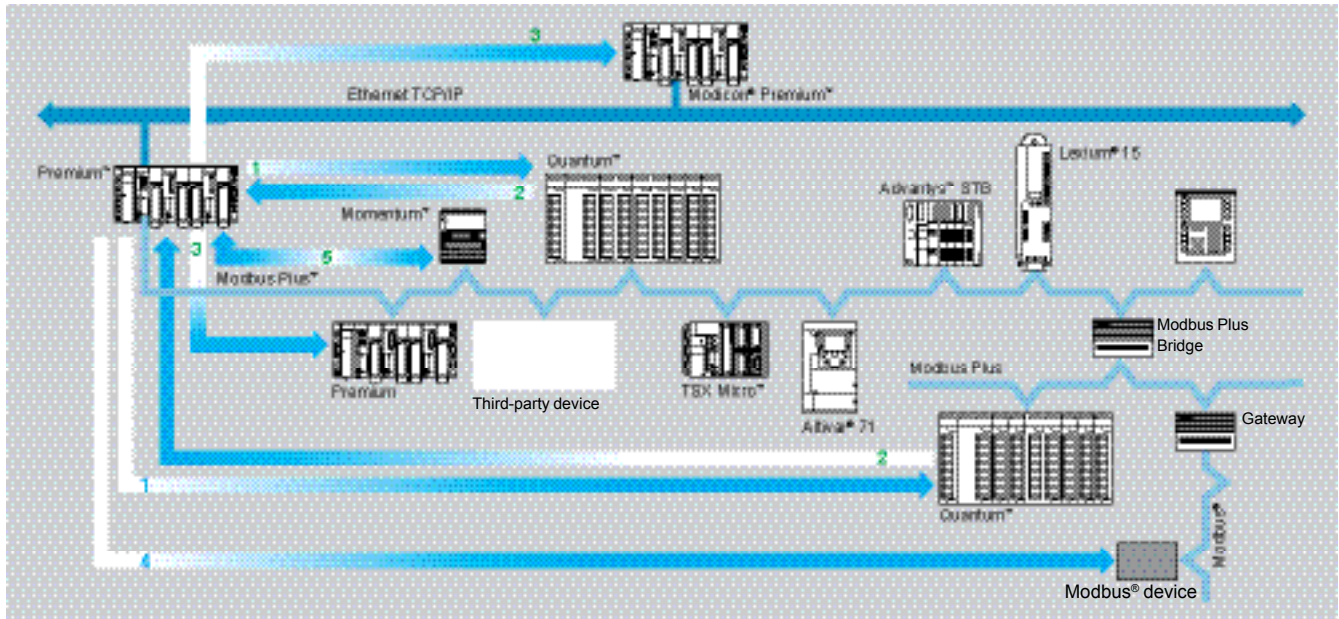

The Modbus Plus™ network is a high-performance industrial local network which can respond to Client/Server type extended architectures, combining a high data rate (1 Mbit/s), simple and economical transmission support, and several message handling services.

The main data exchange functions between devices connected to the network are:

- The message exchange function according to the Modbus® protocol.
- The “global database” function (Shared Table service, periodic, controlled by the application: a station with the token can send 32 words to a maximum of 63 other stations connected on the network).

- 1 The Modicon® Premium™ or TSX Micro™ client communicates with the Modicon® Quantum™ server on the Modbus Plus™ network via function block (communication function).
- 2 The Quantum client communicates with the Premium server on the Modbus Plus network via MSTR function blocks.
- 3 A Premium (or TSX Micro) client connected to the Ethernet TCP/IP or Fipway® network can communicate in read/write mode with a Modbus Plus station (the Premium PLC therefore acts as a gateway).
- 4 A Premium (or TSX Micro) client connected to the Modbus Plus network can access a remote station via the Modbus Plus/Modbus gateway.
- 5 A Premium client connected to the Modbus Plus network can make exchanges with the Momentum™ distributed inputs/outputs via the Peer cop function.

## Description

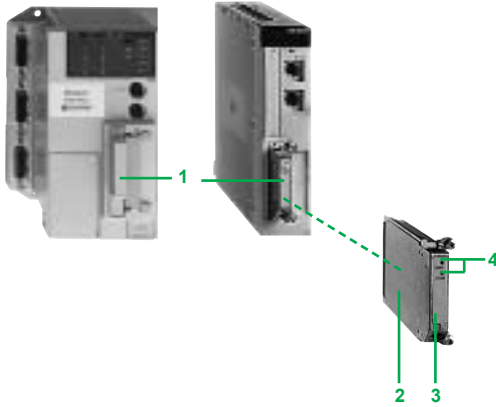

The type III **TSX™ MBP 100** card is used to connect the Modicon® Premium™/TSX Micro™ PLCs to the Modbus Plus™ network. This card is installed in the slot reserved for processors or slot-PLC features:

- 1 Host slot on processors or slot-PLCs.
- 2 Protective cover.
- 3 Removable cover with fixing screw (access to 20-way miniature connector).
- 4 Two indicator lamps:
  - ERR: detected card or link fault,
  - COM: activity on the line.

To be ordered separately: **TSX™ MBP CE 0●●** drop cables.

## Characteristics

<b>Structure</b>	Type	Industrial bus
	Physical interface	RS 485
	Method of access	Token bus
<b>Transmission</b>	Mode	Synchronous HDLC
	Data rate	1 Mbit/s
	Medium	Twisted pair
<b>Configuration</b>	Number of devices	32 per segment, 64 maximum on all segments (1,800 m maximum)
	Number of addresses	64 devices maximum per segment
	Length of bus	450 m maximum per segment, 1,800 m maximum with 3 repeaters
	Number of segments	Cascaded: 5 maximum using Modbus Plus BP85 bridges
<b>Services</b>	Global database	- 4096 byte common database - cyclical exchange of 32 broadcast words
	"Peer to peer" dialog	Read/write services (number of requests: 100 registers per transaction)
	Peer Cop	Cyclical exchange service (on Premium only): 500 words per station (broadcast or point-to-point)

### Wiring system

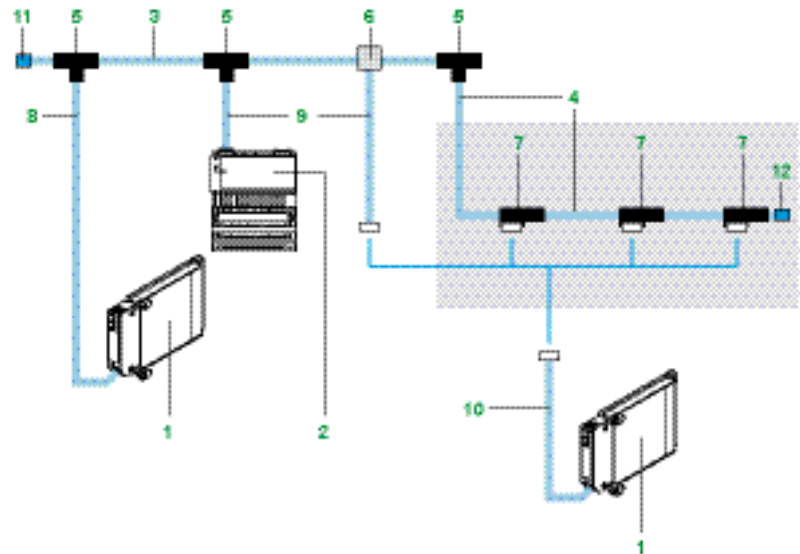

- 1 TSX™ MBP 100: Modbus Plus™ PCMCIA card, for type III processor slot on Modicon® Premium™ or TSX Micro™ platforms.
- 2 170 PNT 110 20: communication module for Momentum™ I/O base unit.
- 3 490 NAA 271 0●: trunk cable, shielded twisted pair with shielding drain (flying leads). In lengths of 30, 150, 300, 450 or 1,500 m.
- 4 170 MCI 020/021 ●●: drop cable equipped at each end with an RJ45 connector (baseT interface). In lengths of 0.25, 0.75, 3 or 10 m.
- 5 990 NAD 230 00: IP 20 local site tap, provides a tap link from the trunk cable for connecting 1 device (connection of conductors requires wiring tool **043 509 383**). Integrates the line terminal.
- 6 Local site taps provides a tap link from the trunk cable for 1 device (screw terminal connection). It also has an RJ45 connector for connecting a programming and maintenance terminals:
  - 990 NAD 230 20/21: IP 20 plastic tap,
  - 990 NAD 230 10: IP 65 zamac tap.
- 7 170 XTS 020 00: IP 20 tee, provides a tap link from the Modbus Plus cable (cable with connectors at each end of an RJ45 connector). It has a 9-way SUB-D female connector for connecting the device.
- 8 TSX MBP CE 030/060: drop cable for Modbus Plus PCMCIA card, equipped on the PCMCIA side with a 20-way miniature connector and with flying leads on the 990 NAD 230 00/10 local site tap side. In lengths of 3 or 6 m.
- 9 990 NAD 211 10/30: drop cable with a 9-way SUB-D male connector for connecting the device and with flying leads on the 990 NAD 230 00/10 local site tap side. In lengths of 2, 4 or 6 m.
- 10 TSX MBP CE 002: drop cable for Modbus Plus PCMCIA card, equipped on the PCMCIA side with a 20-way miniature connector and on the network side with a 9-way SUB-D female connector. Can be used as an extension for cable 990 NAD 211 10/30. In lengths of 0.2 m.
- 11 AS MBKT 185: set of 2 line terminators (impedance adapter) to be placed at each end of the segment. The AS MBKT 185 terminators are placed directly at the end of the cable (without a tap or tee).
  - 990 NAD 230 11: set of 2 line terminators (impedance adapter) for IP 65 local site tap 990 NAD 230 10, to be placed at each end of the segment.
- 12 170 XTS 021 00: set of 2 line terminators (impedance adapter) for tee
  - 170 XTS 020 00, to be placed at each end of the segment.

**Note:** For wiring system:

- Quantum™ platform: please refer to our catalog.
- Lexium® drive for brushless motors: please refer to our catalog "Lexium motion control".
- Altivar® drive for asynchronous motors: please refer to our catalog "Soft starters and speed drives".

## Reference



TSX MBP 100



STB NMP 2212



170 PNT 110 20



TSX MBP CE 030/060

Description	Number per PLC Use	Rep.	Composition	Reference	Weight kg
<b>Modbus Plus PCMCIA card</b>	1 with TSX Micro™ Type III slot on: TSX 37 21/22 - TSX 37 21/22 PLC 1 with Premium™ - Premium processor TSX 57 1●/2●/3●/4●/5●/6●	1	1 PCMCIA type III card	TSX™ MBP 100	0.110

Description	Connection	Rep.	Reference (1)	Weight kg
<b>Distributed I/O on Modbus Plus™ network</b>	Advantys™ STB network interface module	–	STB NMP 2212	0.145
	Momentum™ communication module	2	170 PNT 110 20	0.110

## Connection accessories (1)

Description	Use	Mounting	Rep.	Reference	Weight kg
<b>Modbus Plus taps</b>	IP 20 tee, requires the wiring tool 043 509 283. Integrates the line terminal	–	5	990 NAD 230 00	0.230
	IP 20 tap for tap link connection (screw terminal connection), supports 1 RJ45 connector on front panel	DIN rail	6	990 NAD 230 20	–
		Mounting plate	6	990 NAD 230 21	–
	IP 65 tap for tap link connection (tee), supports 1 RJ45 connector on front panel	Mounting plate	6	990 NAD 230 10	0.650
<b>Line terminators</b> Sold in lot of 2	IP 20 tee with 2 RJ45 connectors for Modbus Plus cable and 1 9-way SUB-D connector for tap link devices	–	7	170 XTS 020 00	0.260
	For tap (IP 20) 990 NAD 230 20/21	–	11	990 NAD 230 22	–
	For tap (IP 65) 990 NAD 230 10	–	11	990 NAD 230 11	–
	For tee (IP 20) 170 XTS 020 00	–	12	170 XTS 021 00	–
<b>Mounting kit for IP 65 tee</b>	Used directly at the end of the cable (without a tap or tee)	–	11	AS MBKT 185	–
	DIN rail mounting for 990 NAD 230 10 local site tap	–	–	990 NAD 230 12	–
<b>Protector pack</b> Sold in lot of 4	Replacement port protectors to prevent ingress into the RJ45 quick connect programming port of 990 NAD 230 10 tap	–	–	990 NAD 230 23	–
	<b>Wiring tool</b>	Mounting trunk and tap wires in the local site tap.	–	043 509 383	–

## Connection cables (1)

Description	Use		Rep.	Length	Reference	Weight kg
	From	To				
<b>Modbus Plus trunk cables</b>	Local site tap	Local site tap 990 NAD 230 00/10	3	30 m	490 NAA 271 01	–
		150 m		490 NAA 271 02	–	
		300 m		490 NAA 271 03	–	
		450 m		490 NAA 271 04	–	
		1,500 m		490 NAA 271 06	–	
<b>Drop cables</b>	IP 20 170 XTS 020 00 tee	IP 20 170 XTS 020 00 tee	4	0.25 m	170 MCI 020 10	–
				1 m	170 MCI 020 36	–
				3 m	170 MCI 021 20	–
				10 m	170 MCI 020 80	–
	PCMCIA card TSX MBP 100 (miniature connector)	Drop cable with 9 way male SUB-D connector	10	0.2 m	TSX MBP CE 002	–
		Local site tap 990 NAD 230 00/10			8	3 m
	Communication module for Momentum I/O base units	Local site tap 990 NAD 230 00/10	9	2.4 m	990 NAD 211 10	0.530
					6 m	990 NAD 211 30

(1) For other Modbus Plus™ network connecting cables and accessories, please consult your Schneider Electric Regional Sales Office.

## Presentation

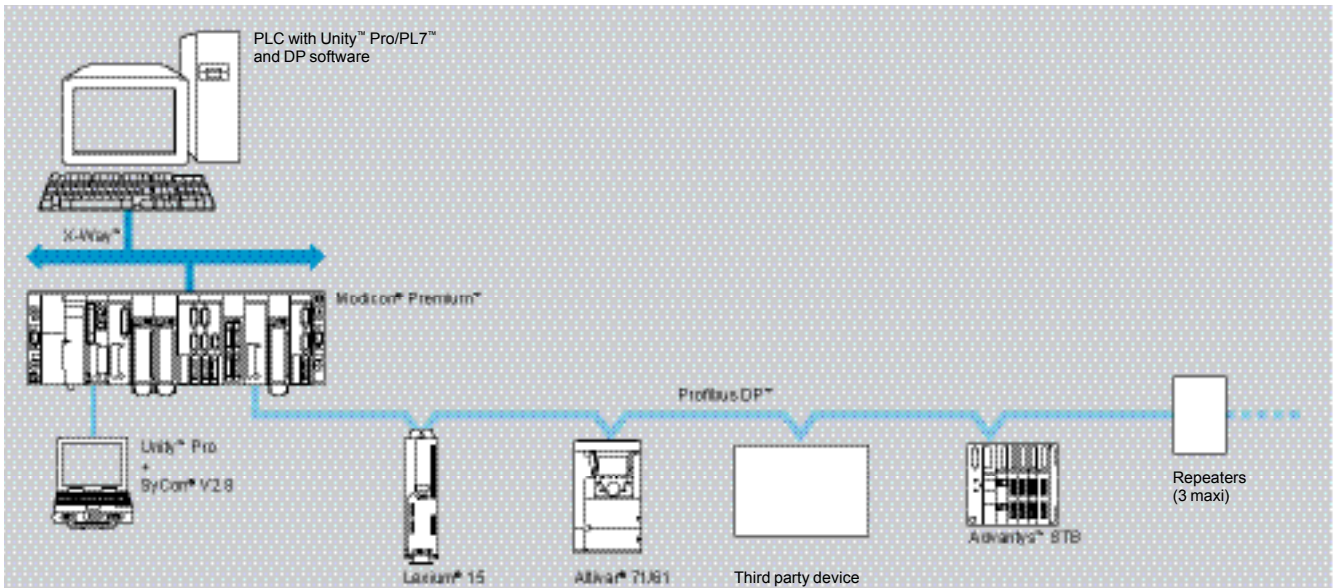

The Profibus DP™ bus is a high-speed fieldbus which conforms to industrial communication requirements.

The Profibus DP is a linear bus with a centralized access procedure of the master/slave type. Only master stations, also known as active stations, have access rights to the bus. The slave or passive stations can only respond to prompts. Dialog between masters is also possible from some stations by means of a token bus protocol. The physical connection is a single shielded twisted pair, but fiber-optic interfaces are available to create tree, star, or ring structures. Compared to the ISO model, only layers 1, 2 are implemented, since access from the user interface is made directly to the link layer via simple mapping of variables.

### Configuration

The Profibus DP bus is configured using dedicated SyCon® software, which should be ordered separately, reference **SYC SPU LF● CD28M**.

This software is used to generate the file including the information relating to the devices connected. This extension file is imported into the PLC application via the Unity™ Pro or PL7™ Junior/Pro programming software.

### Description

Premium™ PLCs are connected to the Profibus DP bus by a **TSX™ PBY 100** module. This module can be installed in any slot in the Premium PLC rack. It is comprised of:

- 1 Host module for the PCMCIA card.
- 2 Profibus DP PCMCIA card with its integral connecting cable, 0.6 m long.
- 3 T-junction box enabling the tap link of the main bus **490 NAE 911 00**.

### Connectable devices

The **TSX PBY 110** module performs the role of the master on the Profibus DP bus. The Schneider Electric devices (slaves) which can be connected on the bus are:

- TeSys® model U starter-controllers, via Modbus® gateway.
- Advantys™ STB and Momentum™ distributed I/O.
- Advantys™ FTB/FTM, IP 67 monobloc and modular I/O splitter boxes.
- Altivar® 61/71, variable speed drives for asynchronous motors.
- Lexium® 15 servodrives for brushless motors.
- Altistart® ATS 48 soft starters.
- And any third-party device which conforms to the Profibus DP™ standard profile.

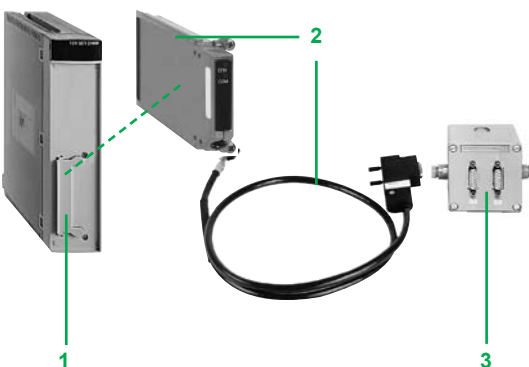



### Characteristics of the bus supported by the module

Type of bus		Profibus DP™
<b>Structure</b>	Type	Industrial bus
	Physical interface	RS 485
	Method of access	Master
<b>Transmission</b>	Mode	NRZ
	Medium	Shielded twisted pair, fiber-optic, infra-red
<b>Physical configuration</b>	Data rate	- to 9.6 K bit/s with the length of 1200 m (4800 m with 3 repeaters) - from 12 M bit/s with the length of 100 m (400 m with 3 repeaters)
	Number of slaves	126
	Number of inputs/outputs	3872 inputs/3872 outputs (242 %IW words, 242 %QW words)
<b>Services (VO)</b>	Subset of Class 1 master function	Read/write DP slave I/O data Transfer slave diagnostic data Set slave parameters (on power-up) Check slave configurations (on power-up)
	Subset of Class 2 master function	Manage monitoring requests: Global_CONTROL and Get_Master_Diag master/master dialog is not supported



TSX PBY 100

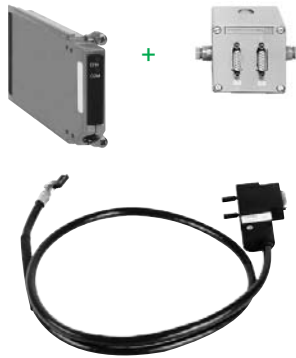

### References

Description	Communi- cation profile	Services	Reference	Weight kg
<b>Profibus DP module kit for Premium™ PLC (1)</b>	Master/slave 12 Mbit/s	Class 1 and Class 2 V0 master functions, see characteristics Profibus FMS message handling not supported	<b>TSX™ PBY 100</b>	0.870
<b>SyCon® V2.8 configuration software</b>	–	Generates an ASCII configuration file for the module to be imported into the Unity™ Pro or PL7™ application	<b>See page 5/65</b>	–

Description	Type of license	Reference	Weight kg
<b>SyCon V2.8 configuration software licenses</b>	Single (1 station)	<b>SYC SPU LFU CD28M</b>	–
	Group (3 stations)	<b>SYC SPU LFG CD28M</b>	–
	Team (10 stations)	<b>SYC SPU LFT CD28M</b>	–
	Site (> 10 stations)	<b>SYC SPU LFF CD28M</b>	–
<b>SyCon V2.8 configuration software update</b>	Single (1 station)	<b>SYC SPU LRU CD28M</b>	–
<b>SyCon V2.8 configuration software update for previous version</b>	Group (3 stations)	<b>SYC SPU LUG CD28M</b>	–
	Team (10 stations)	<b>SYC SPU LUT CD28M</b>	–
	Site (> 10 stations)	<b>SYC SPU LUF CD28M</b>	–

### Elements for connection to Profibus DP bus

Description	Use	Reference	Weight kg
<b>IP 20 distributed I/O on Profibus DP™</b>	Advantys™ STB network interface module	<b>STB NDP 2112</b>	0.140
	Momentum™ communication module	<b>170 DTN 110 00</b>	0.070
<b>Connectors for communication module</b>	Line terminator	<b>490 NAD 911 03</b>	–
	Intermediate connection	<b>490 NAD 911 04</b>	–
	Intermediate connection and terminal port	<b>490 NAD 911 05</b>	–

Description	Length	Reference	Weight kg
<b>Profibus DP connecting cables</b>	100 m	<b>TSX PBS CA 100</b>	–
	400 m	<b>TSX PBS CA 400</b>	–

### Replacement parts

Description	Use	Reference	Weight kg
<b>Main bus tap</b>	Included in TSX PBY 100 kit	<b>490 NAE 911 00</b>	–
<b>PCMCIA card</b>	Included in TSX PBY 100 kit	<b>467 NHP 811 00</b>	–

(1) Maximum number of fieldbus (INTERBUS or Profibus DP) per processor, see pages 1/12, 1/13, 1/31 and 1/21.



490 NAD 911 03

## Presentation

The INTERBUS® bus is a serial link type fieldbus for sensors and actuators which conforms to the requirements of an industrial environment.

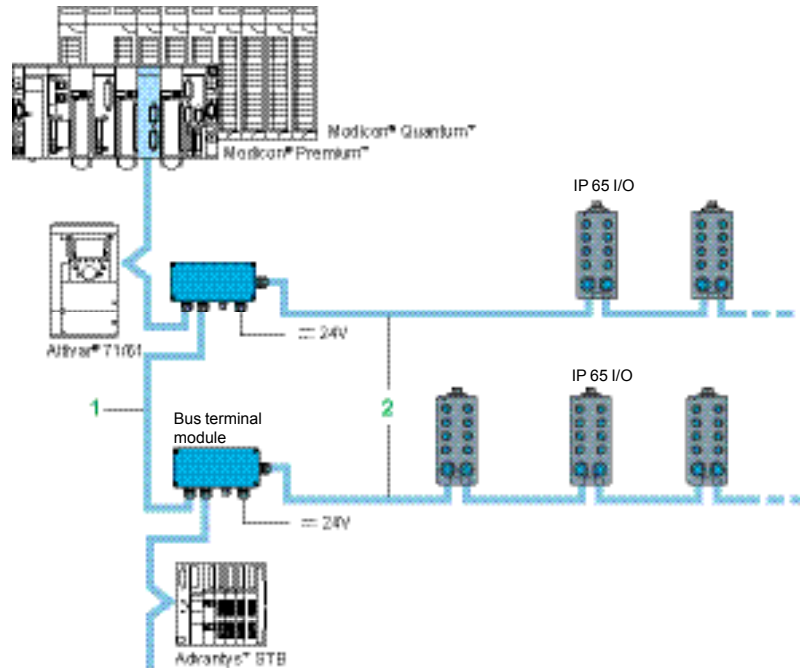

The topology of the INTERBUS® bus is designed as a ring system with master/slave central access procedure.

It is subdivided into three parts:

- The remote bus 1 (bus devices use RS 485 point-to-point connection).
- The installation remote bus 2 (remote bus tap link via a bus terminal module). Its technology is particularly suitable for IP 65 dust and damp proof systems.
- The local bus with TTL technology is particularly suitable for buses within a control cabinet.

Each bus subscriber is comprised of a transmitter and a receiver.

The INTERBUS system is like a data ring and has the structure of a shift register distributed on the bus. With its registers, each module constitutes a component of this shift register ring. The INTERBUS master circulates the data in series on this ring.

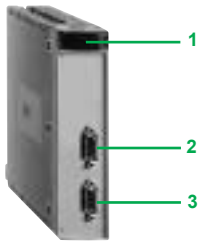

TSX IBY 100

## Description

Modicon® Premium™ PLCs are connected to the INTERBUS® bus via the **TSX™ IBY 100** INTERBUS bus module.

The front panel on the **TSX IBY 100/IBX 100** module features:

- 1 Display block with 6 indicator lamps (on the card for the TSX IBX 100).
- 2 9-way female RS 232 SUB-D connector: CMD Tool software support (configuration software).
- 3 9-way female RS 485 SUB-D connector: InterBus link (this connector integrates an additional power supply for the fiber-optic link).

## Connectable devices

The **TSX IBY 100** module or the **TSX IBX 100** card acts as the master on the INTERBUS® bus. Other Schneider Electric devices (slaves) that can be connected on the bus are:

- Altivar® 71/61 variable speed drives for asynchronous motors.
- Advantys™ Telefast IP 20 I/O interfaces.
- Advantys™ STB IP20 modular distributed inputs/outputs.
- Advantys™ IP 67 FTB monobloc splitter boxes.
- Momentum™ IP20 distributed inputs/outputs.
- Distributed discrete dust and damp proof I/O (IP 65).
- Inductel inductive identification systems (XGP/XGK-S read/write stations).
- AS-Interface®/INTERBUS gateway.
- Any third-party device conforming to InterBus standard profiles.

**Characteristics of the bus supported by TSX™ IBY 100 modules or TSX™ IBX 100 co-processors**

Type of bus		Remote bus	Installation remote bus	Local bus	INTERBUS® loop
<b>Structure</b>	Type	Industrial bus			
	Physical interface	RS 485	RS 485 with ∓ 24 V in cable	TTL	Combined interface (vertically mounted signal and ∓ 24 V power supply)
	Method of access	Master/slave			
<b>Transmission</b>	Mode	NRZ			
	Data rate	500 Kbit/s			
	Medium	- Twisted pair - Fiber-optic - Wave guide rail - Infra-red - Rotating collector	Special cable for: Sensor and I/O module 24V power supply Data transmission	Special cable	2 x 1.5 mm <sup>2</sup>
<b>Physical configuration</b>	Length of segment	400 m maxi	–	–	200 m max. in the loop
	Maximum length of cable between:	- Module and the 1 <sup>st</sup> bus terminal module: 400 m - 2 bus term.modules: 400 m	- Bus terminal module and 1 <sup>st</sup> module: 50 m - 2 modules: 50 m	- Bus terminal module and 1 <sup>st</sup> module: 1.5 m - 2 modules: 1.5 m	- Bus terminal module and 1 <sup>st</sup> interface: 20 m - 2 modules: 10 m
		Module and last station on the remote bus: 12.8 km	The bus terminal module and last module: 50 m	Bus terminal module and last module: 10 m	Bus terminal module and last module: 100 m
	Number of tap links	16 maxi	–	–	1 loop per bus terminal module
	Number of bus terminal modules	254 maxi	–	–	–
	Number of slaves	512 maxi	Total current of connected modules: 4.5 A max.	8	63
	Number of I/O	3872 I/3872 O max. (4096 I/O in total)	–	–	–
<b>INTERBUS services</b>	Implicit exchange of process data: 242 %IW and 242 %QW				
	Pre-processing				
	Logical addressing				
	Segmentation				

5

**Software configuration**

The INTERBUS® bus can be configured in 3 modes:

- Auto mode: This mode does not require the use of any special configuration software (I/O images are copied to %IW, %QW implicitly). This facilitates the wiring check.
- Mode Unity™ Pro / PL7™ → IBY mode: This mode is used to define and load the configuration to the module (explicit assignment of %IW, %QW). The CMD Tool software (1) is required in order to generate the configuration text file.
- CMD → IBY mode: Reserved for configurations > 8 K words, and requires the use of the CMD Tool software.

PMS message handling (usable on PCP devices) is managed via standard OFs (Read-var, Write-var, etc).

The catalog file which enables Schneider Electric devices to be integrated in the CMD Tool software is available on our Web site:

- Address: [www.schneider-electric.com](http://www.schneider-electric.com)
- File for downloading: Schneider device catalog for CMD.

(1) Contact your Phoenix Contact vendor.



TSX IBY 100



TSX IBX 100



STB NIB 2212



170 INT 110 00

## References

### INTERBUS® bus modules

Description	No. of modules per PLC/PC	Communication profile	Services	Reference	Weight kg
INTERBUS module for Premium™ PLC	See pages 1/12, 1/13 and 1/31	Master/slave 0.5 Mbit/s Generation 4	- Cyclical variable exchanges - PMS messaging - Bus operating modes management	TSX™ IBY 100	0.320
INTERBUS coprocessor	See page 1/21	Master/slave 0.5 Mbit/s Generation 4	- Cyclical variable exchanges - PMS messaging - Bus operating modes management	TSX™ IBX 100	0.280

### Converter software

Description	Use	Reference	Weight kg
Symbol converter software	Used to convert CMD symbols into Unity™ Pro or PL7™ symbols	TLX LIBS CNVE	–

### Bus connection elements

Description	Use	Length	Reference	Weight kg
IP 20 distributed inputs/outputs	Avantys™ STB distributed I/O	–	STB NIB 2212	0.155
	Momentum™ I/O base units on INTERBUS bus	–	170 INT 110 00	0.070
Remote bus cables	–	100 m	TSX IBS CA 100	7.340
		400 m	TSX IBS CA 400	24.020
Installation remote bus cables	Preformed cables for linking 2 communication modules	0.110 m	170 MCI 007 00	0.060
		1 m	170 MCI 100 00	0.320
Connecting cable	TSX IB to PC connection (with CMD Tool software)	6 m	990 NAA 263 20	–
		15 m	990 NAA 263 50	–
Connectors <i>Sold in lots of 2</i>	9-way SUB-D type for remote bus cables	–	170 XTS 009 00	0.045

### Presentation

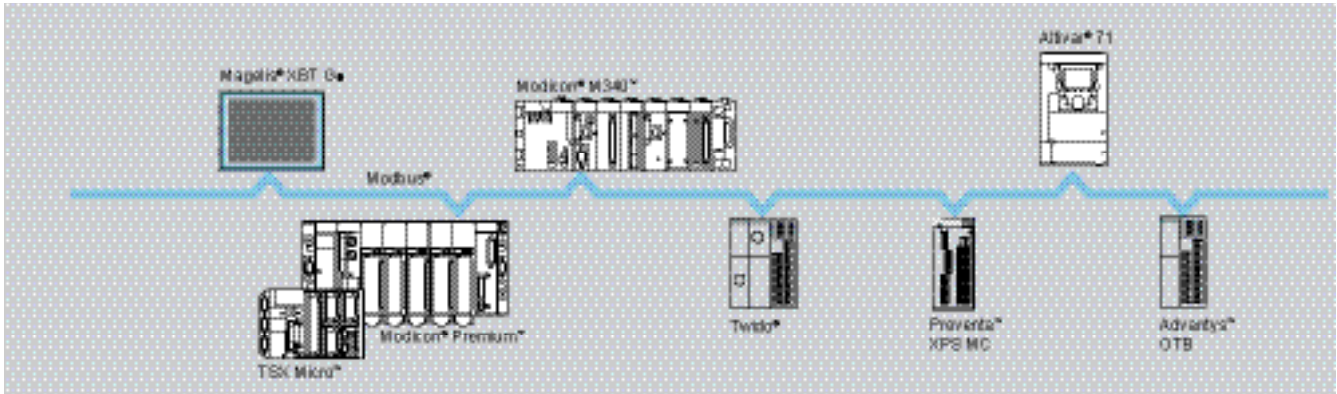

The Modbus® bus is used for master/slave architectures. For optimum performance, it is important to verify that the Modbus® services provided by this application can be implemented on the specific devices within the architecture.

The bus is comprised of one master station and several slave stations. Only the master station can initiate the exchange (direct communication between slave stations is not possible). Two exchange mechanisms are possible:

- Question/answer, where the requests from the master are addressed to a given slave. The master then waits for the response from the slave which has been interrogated.
- Broadcasting, the master broadcasts a message to the slave stations on the bus. These stations execute the order without transmitting a response.

5

### Description

Modicon® Premium™ or TSX Micro™ offer various Modbus® bus connection possibilities.

#### Built-in link to the TSX Micro or to the Premium module TSX™ SCY ●1601

- 1 Via integrated port on the TSX Micro processor.  
The TER port (8-way mini DIN) has Modbus RTU master/slave (1) protocol.
- 2 Via integrated port on the **TSX SCY 11601/21601** module for Premium PLCs.  
This module has an isolated Half-duplex RS 485 serial link channel (25-way SUB-D connector) with multiprotocol (including Modbus); (for the TSX SCY 11601 module, only the Modbus protocol is supported).

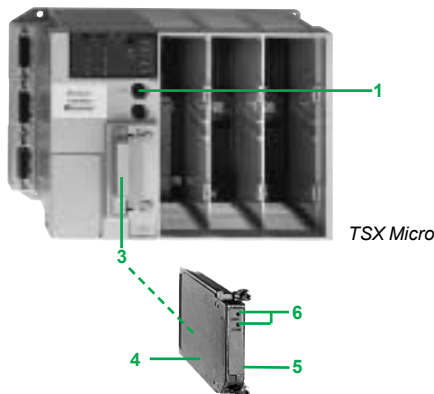

#### TSX™ SCP 11● multiprotocol PCMCIA cards

- 3 A slot on the TSX Micro/Premium processors and the **TSX SCY 21601** module(2) exists for the multiprotocol **TSX SCP11●** cards, including Modbus, featuring:
  - 4 A protective cover.
  - 5 A removable cover with fixing screws (to access a 20-way miniature connector).
  - 6 Two LEDs:
    - ERR lamp: detected card or link fault,
    - COM lamp: data transmission or reception.

**To be ordered separately: TSX SCP/SCY cordset.**

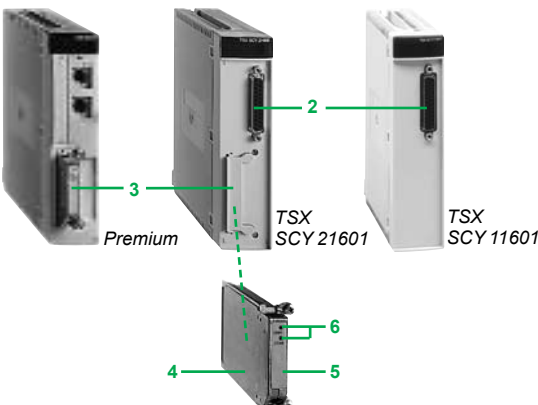

(1) Modbus RTU slave Protocol with TSX 37 05/08.

(2) This slot is also designed for Fipway **TSX FPP 20** PCMCIA network cards.





Characteristics								
Physical Interface		TSX Micro™ terminal port		PCMCIA card			TSX™ SCY integrated port for Premium™ Isolated RS 485	
		Non-isolated RS 485		Isolated RS 485 (1)	20 mA CL	Non-isolated RS 232	TSX SCY 11601	TSX SCY 21601
		TSX™ 37 05/08	TSX 37 10/21/22					
<b>Structure</b>	Type	Heterogeneous industrial bus						
	Method of access	Slave	Master/slave	Master/slave Type				
<b>Transmission</b>	Mode	Asynchronous in baseband						
	Frame	RTU		RTU/ASCII				
	Data rate	1.2...14.2 Kbit/s		0.6..19.2 Kbit/s for TSX SCP 111 1.2... 19.2 Kbit/s for <b>TSX™ SCP 112/114</b>			1.2...19.2 Kbit/s	
	Medium	Double shielded twisted pair			Double shielded twisted pair, doubled	Quintuple shielded twisted pair	Double shielded twisted pair	
<b>Configuration</b>	Number of devices	28 max. in RS 485 Point-to-point in RS 422		16 max.	2 (point-to-point)	32		
	Max. number of link addresses	98	248	98			248	98
	Length of bus	10 m max. non isolated link 1,300 m max. on isolated link (2)		1,300 m excluding tap links	100...1,000 m according to rate	15 m max.	1,300 m excluding	
	Tap links	-		15 m max.	-	-	15 m	
<b>Services</b>	Requests	Bits: 1,920 bits per request Words: 120 words per request						
	Security	One CRC 16 check parameter on each frame						
	Monitoring	No flow control			Diagnostic counters, event counters			
<b>Modbus® functions available on Premium™ or TSX Micro™ PLCs</b>		Code	Modbus slave			Modbus master		
		01	Read n output bits			Read bits		
		02	Read n input bits			Read input bits (3)		
		03	Read n output words			Read words		
		04	Read n input words			Read input words (3)		
		05	Write 1 output bit			Write 1 bit or n bits		
		06	Write 1 output word			Write 1 word or n words		
		07	Exceptional read status			Exceptional read status		
		08	Diagnostic			Diagnostic		
		0B	Event counter			Event counter		
		0C	Event connection			Event connection		
		0F	Write n output bits			-		
		10	Write n output words			-		
		11	Identification			Slave identification		
-	-			Other requests accessible via SEND_REQ generic function blocks				

(1) Point-to-point RS 422 compatible connection.





(2) For an isolated link, you must use the **TWD XCA ISO Modbus TAP** isolation.

(3) Requests not available on TSX 37 10/21/22 terminal port.

### Modbus® bus connection elements

		Description	Protocol	Physical layer	Reference	Weight kg
 <p>TSX Micro</p>	 <p>TSX SCP 11</p>	TSX Micro™ PLC integrated link (TER port)	Modbus® (RTU) Uni-Telway™ character mode	Non-isolated RS 485	Consult our catalog <a href="http://www.schneider-electric.com">www.schneider-electric.com</a>	
		Communication module for Premium™	Modbus Character mode Uni-Telway	- 1 RS 485 isolated integrated channel (channel 0), (1...97 slaves) - 1 slot for PCMCIA card (channel 1) (1)	<b>TSX™ SCY 21601</b>	0.360
 <p>TSX SCY 21601</p>	 <p>TSX SCY 11601</p>	PCMCIA cards for Premium processor, PLC TSX 37 21/22 or TSX SCY 21601 module	Modbus	RS 485 (RS 422 compatible)	<b>TSX™ SCP 114</b>	0.105
			Character mode Uni-Telway	1.2...19.2. Kbit/s RS 232 (9 signals) 0.6...19.2. Kbit/ 20 mA CL 1.2...19.2. Kbit/s	<b>TSX SCP 111</b> <b>TSX SCP 112</b>	0.105 0.105

### Modbus® connection accessories

		Description	Use	Reference	Weight kg
 <p>TSX SCA 50</p>	 <p>TSX SCA 62</p>	Passive junction box	Bus tap link and extension, line termination adaptation	<b>TSX™ SCA 50</b>	0.520
		2 channel passive subscriber socket (2 or 4 wire) (2)	Tap link of 2 devices with 2 wires Tap link of 1 master device and/or 1 slave device with 4 wires Fitted with 2 female 15-pin SUB-D connectors	<b>TSX SCA 62</b>	0.570
 <p>TSX SCA 62</p>	 <p>TSX SCA 72</p>	RS 485 TAP isolation	RS 485 line isolation (1) Line end adapter (RC 120 Ω, 1nF) Screw terminal for trunk cable and 2 x RJ45 for derivation ± 24 V supply (screw terminal block) Mounting on 35 mm DIN	<b>TWD XCA ISO</b>	0,100
		TER terminal port cable connector	Bus tap link cable (2 or 4-wire) Isolation of Modbus signals Line termination adaptation Supplied with cable (length 1 m) fitted with a mini-DIN connector (TER port)	<b>TSX™ P ACC 01</b>	0.690
 <p>TWD XCA ISO</p>		Active adapter RS 232/RS 485	Connection of an RS 232 device as RS 485 Isolation of signals and line termination adaptation	<b>TSX SCA 72</b>	0.520
		Line terminators Sold in lot of 2	2/4-wire cabling Can be connected to the front panel of the TSX SCA 62 subscriber socket	<b>TSX SCA 10</b>	0.030

(1) PCMCIA slot for 1 TSX SCP 111/112/114 or TSX FPP 20 card.  
(2) Line isolation recommended for the length > 20 m.



### Modbus® connection cables

Description	Use From	To	Length	Reference	Weight kg	
RS 485 double shielded twisted pair trunk cables	Modbus® Bus	–	100 m	TSX™ CSA 100	5.680	
			200 m	TSX CSA 200	10.920	
			500 m	TSX CSA 500	30.000	
Cables for isolated RS 422/485 tap link	TSX™ SCP 114 card	TSX SCA 50 housing 2 wires (1)	3 m	TSX™ SCP CM 4030	0.160	
		TSX SCA 62 subscriber socket, 2/4 wires	3 m	TSX SCP CM 4530	0,180	
		Modbus® standard device, 4 wires (1) (point-to-point)	3 m	TSX SCP CX 4030	0.160	
	Built-in channel (channel 0) Premium™ module TSX SCY 11601, TSX SCY 21601	TSX SCA 50 housing, 2 wires (1)	3 m	TSX™ SCY CM 6030	0.160	
		TSX SCA 62 subscriber socket, 2 wires	3 m	TSX SCY CM 6530	0.160	
RS 485 cordsets	Twido® and TSX Micro™ terminal port (mini-DIN connector)	TWD XCA ISO TAP isolation (2 x RJ45 connectors)	0,3 m	TWD™ XCA RJ003	0.040	
			1 m	TWD XCA RJ010	0.090	
			3 m	TWD XCA RJ030	0.160	
RS 232 tap link cordsets	TSX SCP 111 card	Communication device (Modem, converter, etc) (DCE) (2)	3 m	TSX SCP CC 1030	0.190	
			Terminal device with point-to-point (DTE) (2)	3 m	TSX SCP CD 1030	0.190
			10 m	TSX SCP CD 1100	0.620	
Corset for tap link 20 mA CL	TSX SCP 112 card	Multidrop Modbus (1)	3 m	TSX SCP CX 2030	0.160	
Other connecting cables	–	–	–	See page 5/110	–	

(1) End of cordset with free wires.

(2) End of cordset fitted with a male 25-pin SUB-D connector.

### Presentation

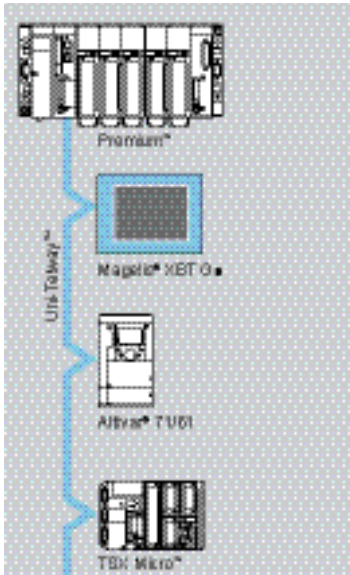

The Uni-Telway™ bus is a standard means of communication between control system components (PLCs, MMI terminals, supervisors, variable speed drives, numerical controllers, weighing equipment, etc.).

It is suitable for architectures designed to manage control and monitoring devices via a PLC, or architectures used for MMI (supervision, etc.).

The Uni-Telway bus requires a master station which manages the allocation of bus access rights to the various connected stations (known as slave stations).

5

### Characteristics

Physical interface		RS 485 non isolated terminal port (TER/AUX)	Premium™ RS 485 isolated module integrated port (1)	Isolated RS 485/RS 422 PCMCIA card	20 mA CL PCMCIA card	Non-isolated RS 232 PCMCIA card
<b>Structure</b>	Type	Heterogeneous industrial bus				
	Link	Multidrop				Point-to-point
	Method of access	Master/Slave principle				
<b>Transmission</b>	Mode	Asynchronous transmission in baseband				
	Data rate	1.2...19.2 Kbit/s				0.3...19.2 Kbit/s
	Medium	Shielded double twisted pair				
<b>Configuration</b>	Number of devices	5 max.	28 max.	16 max.	2	
	Number of connection addresses	8 max.	96 max.(1 device can occupy several datalink addresses)			
	Length of bus	10 m max., 1,000 m with <b>TSX™ PACC 01</b>	1,000 m max. excluding tap links		1300 m max., excluding tap links	15 m (unlimited via modem)
	Tap links	–	20 m	20 m	15 m	–
<b>Service</b>	Uni-TE™	Point-to-point requests with confirmation (question/response), of up to 240 bytes (2) initiated by any connected device Unsolicited point-to-point data, without confirmation, of up to 240 bytes(2) initiated by any connected device Broadcast messages of up to 240 bytes (2) initiated by the master device				
	Other functions	Transparent communication, via the master, with any device in an X-Way™ architecture Diagnostics, debugging, adjustment and programming of PLCs				
	Security	Check character on each frame, acknowledgement and, if required, repetition of messages helps to ensure security of transmission				
	Monitoring	Bus status table, transmission error counters and device status can be accessed by program in each device Status of the bus and devices connected from the master PLC accessible using Unity™ Pro or PL7™ software.				

(1) **TSX™ SCY 21601** single format module.

(2) Limited to 128 bytes with **TSX Micro/Premium PLC terminal port**.

### Performance

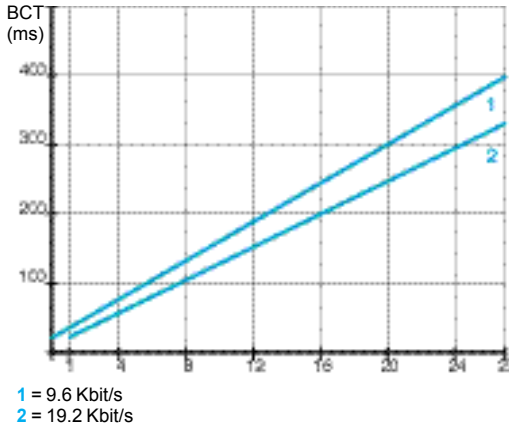

The Uni-Telway™ bus cycle time depends on:

- The number of devices polled (datalink addresses).
- The data rate.
- The turnaround time of each device.
- The number, length and type of messages.

BCT = Bus Cycle Time, is the interval between two polls from the same device.

The curves opposite give the Uni-Telway cycle time as a function of the number of slaves operating at 9.6 Kbit/s or 19.2 Kbit/s, with a typical turnaround time of 5 ms per device (excluding messages).

The following table shows the time to be added (in ms) to obtain the true BCT value as a function of the traffic (N = Number of usable characters):

Exchanges	Time (ms)	
	at 9.6 Kbit/s	at 19.2 Kbit/s
Master to slave	$24 + 1.2 N (1)$	$17 + 0.6 N (1)$
Slave to Master	$19 + 1.2 N (1)$	$12 + 0.6 N (1)$
Slave to slave	$44 + 2.3 N (1)$	$29 + 1.15 N (1)$

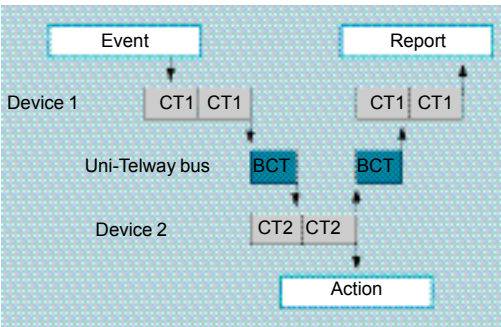

BCT = Uni-Telway bus cycle time  
CT1 = Device 1 bus cycle time  
CT2 = Device 2 bus cycle time

In a distributed control system architecture the application-to-application response time depends not only on the communication system, but also on:

- The processing times of the message source and destination devices.
- The degree of asynchronism between the bus and processor cycle times.

This response time must be evaluated by the designer of each application according to the devices which are connected.

The processing time of a device may vary from one to two cycle times depending on the degrees of asynchronism.

### Description

#### Modicon® Premium™ / TSX Micro™ PLCs

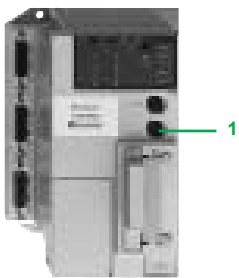

TSX Micro

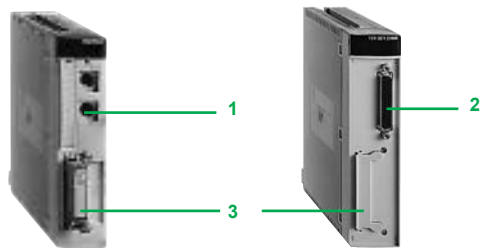

Premium

TSX SCY 21601

Modicon® Premium™ and TSX Micro™ PLCs provide various ways of connecting to the Uni-Telway™ bus.

- 1 By integrated TSX Micro/Premium processor  
The AUX port (2) (8-way mini-DIN) has one non-isolated RS 485 serial link channel (maximum distance 10 m).
- 2 By TSX SCY 21601 integrated port for Premium PLC  
This module has one Half-duplex isolated RS 485 serial link channel, which is multiprotocol, including Uni-Telway™.
- 3 Via multiprotocol PCMCIA card  
A slot on the TSX 37 21/22/Premium PLC processors and the **TSX™ SCY 21601** module (3) accepts the following multiprotocol cards:
  - **TSX SCP 114** PCMCIA card: isolated RS 485/RS 422 link. This type of card corresponds to the Uni-Telway standard.
  - **TSX™ SCP 111** PCMCIA card: non isolated RS 232 link. This type of card can be used for direct point-to-point links or via Modem.
  - **TSX SCP 112** PCMCIA card: 20 mA current loop link. This type of card is used for a multidrop link (2 to 16 devices) and requires a 24 V external power supply.

(1) N = Number of usable characters corresponding to the messages to be exchanged.  
(2) TER port for TSX 37 05/08/10 PLC.  
(3) This slot can also accept the **TSX FPP 20** PCMCIA card for Fipway networks.

### Uni-Telway™ bus wiring system

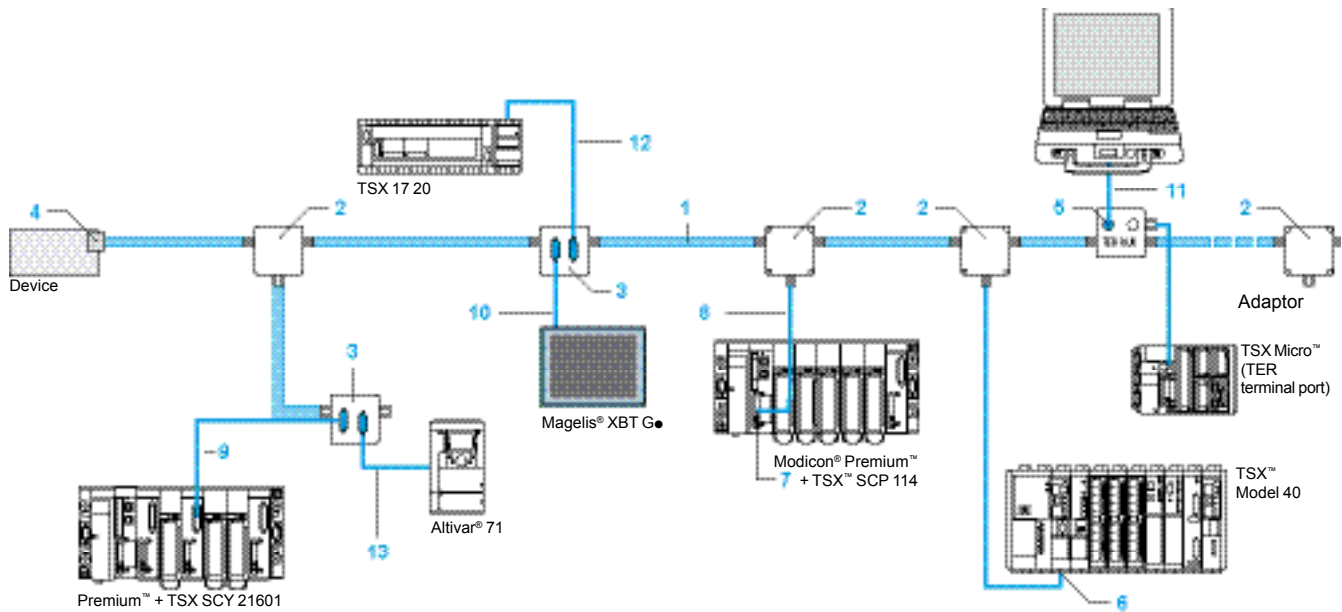

- 1 TSX™ CSA ●●●: bus cable, double shielded twisted pair. The shielding must be connected to the ground of each device.
- 2 TSX™ SCA 50: passive T-junction box, matches the impedance when it is installed at the end of the line.
- 3 TSX SCA 62: passive 2-channel Uni-Telway™ subscriber socket, is used for coding the address of two connected devices, and matching the impedance when it is installed at the end of the line.
- 4 TSX SCA 60/61: passive terminal block, used for intermediate devices that have a 15-way female SUB D connector:
  - **TSX SCA 60** used for intermediate devices,
  - **TSX SCA 61** used for end devices.
- 5 TSX™ P ACC 01: connection box, used for connecting a TSX Micro™/Premium™ PLC to the Uni-Telway bus via the PLC terminal port. The connecting cable (length 1 m) is integrated in the connection box. It isolates the signals (for distances > 10 m) and is used to match the end of line impedance. It is also used to set the operation of the terminal port (Uni-Telway Master/Slave or character mode).
- 6 TSX™ LES 64/74: cable connectors for extensions to the Uni-Telway bus, used to connect TSX model 40 PLC processors that have an integral Uni-Telway port as standard. They are used for coding the address of the connected device.
- 7 TSX™ SCP 114: PCMCIA card for connecting TSX Micro (1)/Premium PLCs to the Uni-Telway bus.
- 8 TSX SCP CU4030: Uni-Telway connecting cable between the **TSX SCP 114** PCMCIA card (on TSX P57 ●0M processor or TSX SCY 21601 module) and the **TSX SCA 50** junction box.
- 9 TSX™ SCY CU6530: Uni-Telway connecting cable between the **TSX SCY 21601** module integrated channel and the **TSX SCA 62** subscriber socket.
- 10 VW3 A8 306: universal connecting cordset (length 3 m) between the Magelis® XBT G● Advanced Panel (port COM2, RJ45 connector) and the **TSX SCA 62** subscriber socket.
- 11 TSX PCX 1031: universal connecting cable between a PC compatible (COM port, 9-way SUB D connector) and the TER or AUX port for TSX Micro/Premium PLCs or the **TSX P ACC 01** connection box (8-way mini-DIN connector).  
 TSX CUSB 485 + TSX CRJDB 25: USB to RS 485 converter and Uni-Telway cordset between a PC compatible (USB port) and the **TSX SCA 62** subscriber socket.
- 12 TSX CSC 015: connecting cordset between the TSX™ 17 micro-PLC (via a TSX 17 ACC5 adapter or a TSX SCG 1161 module) and the **TSX SCA 62** subscriber socket.
- 13 VW3 A8 306 2: connecting cordset (length 3 m) between the Altivar® 61/71 speed drive and the **TSX SCA 62** subscriber socket.

(1) With TSX 37 21/22 PLCs.



TSX Micro



Premium



TSX SCY 21601



TSX SCP 111



TSX P ACC 01



TSX SCA 50

TSX SCA 62



TSX SCA 72



TSX CUSB 485



TSX PCX 1031

### Elements for connection to Uni-Telway™ bus

Description	Protocol	Physical layer	PLC	Rep.	Reference	Weight kg
Integrated link on processor	Uni-Telway Character mode	Non isolated RS 485	TSX Micro™	–	Please consult our site <a href="http://www.schneider-electric.com">www.schneider-electric.com</a> See pages 1/12 and 1/23	
			Premium™	–		
Communication module	Uni-Telway Modbus®/Jbus Character mode	1 isolated 2-wire RS 485 integrated channel (channel 0), 1 PCMCIA card slot (channel 1) (1)	Premium	–	TSX™ SCY 21601	0.360
PCMCIA cards for Premium processors, TSX 37 21/22 PLCs, TSX SCY 21601 modules	Uni-Telway Modbus/Jbus Character mode	RS 232 (9 signals) 0.3...19.2 Kbit/s	7		TSX™ SCP 111	0.105
		RS 485 (RS 422 compatible) 1.2...19.2 Kbit/s	7		TSX SCP 114	0.105
		20 mA CL 1.2...19.2 Kbit/s	7		TSX SCP 112	0.105
Set of X-Way™ drivers for PC compatibles	Includes the X-Way drivers on one CD-ROM	1 CD-ROM	–		TSX™ CD DRV 20M	–

### Uni-Telway™ bus connection accessories

Description	Use	Rep.	Reference	Weight kg
Terminal port connection box	Isolation of Uni-Telway signals for bus length > 10 m, end of line adaptation, bus cable tap links. Supplied with cable (1 m length) equipped with a mini-DIN connector (TER or AUX ports)	5	TSX™ P ACC 01	0.690
Passive T-junction box	Tap link and extension of bus cable,	2	TSX™ SCA 50	0.520
Passive 2-channel subscriber socket	2-channel tap link (15-way female SUB-D connector) and extension of bus cable, address coding and end of line adaptation	3	TSX SCA 62	0.570
Active adaptation box RS 232/RS 485	Connection of an RS 232 device active adapter unit (using Uni-Telway protocol), adaptation and isolation of signals, end of line adaptation (no address coding)	–	TSX SCA 72	0.520

### Uni-Telway™ bus connecting cables (2)

Description	Use		Rep.	Length	Reference	Weight kg
	From	To				
Double shielded twisted pair RS 485 cables	Uni-Telway bus	–	1	100 m	TSX™ CSA 100	5.680
				200 m	TSX CSA 200	10.920
				500 m	TSX CSA 500	30.000
Cables for isolated RS 485 tap link	TSX SCP 114 card	TSX SCA 50 T-jun. box	8	3 m	TSX SCP CU 4030	0.160
		TSX SCA 62 sub. sock.	–	3 m	TSX SCP CU 4530	0.180
	TSX SCY 21601 module integrat. channel (ch. 0)	TSX SCA 50 T-jun. box	–	3 m	TSX SCP CU 6030	0.180
		TSX SCA 62 sub. sock.	9	3 m	TSX SCP CU 6530	0.200
	PC terminal (USB port)	TSX SCA 62 sub. sock	–	0.4 m	TSX™ CUSB 485 (3)	0.144
			2.5 m	TSX™ CRJDB 25 (3)	0.160	
RS 232 terminal port/peripheral device connecting cable	TSX Micro/ Premium, TSX P ACC 01 box (TER or AUX)	RS 232 port for 9-way SUB D type PC compatible	11	2.5 m	TSX™ PCX 1031	0.170
		USB port of PC (USB/RS 485 converter)	–	0.4 m	TSX™ CUSB 485 (4)	0.144
		USB port of PC (mini-DIN/RJ45 cordset)	–	2.5 m	TSX CRJDB 25 (4)	0.160

(1) Type III PCMCIA type III slot for TSX SCP 111/112/114, TSX FPP 20 card

(2) For information on other connection cables, please see pages 5/108

(3) With TSX CUSB 485 converter, use the TSX CRJDB 25 cordset (equipped with 1 x 25-way SUB-D and 1 x RJ45).

(4) With TSX CUSB 485 converter, use the TSX CRJDB 25 cordset (equipped with 1 x mini-DIN and 1 x RJ45).

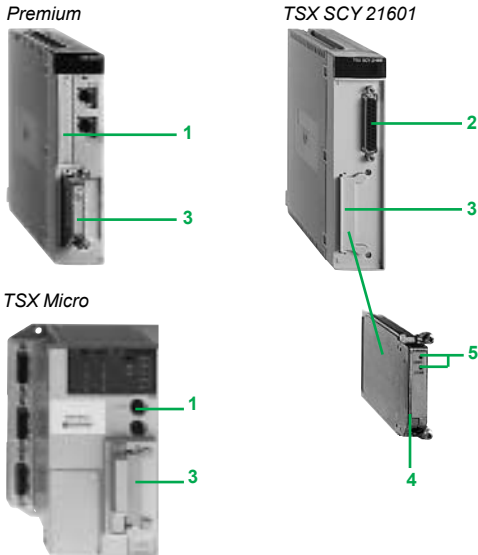

### Presentation

TSX Micro™ and Premium™ PLCs provide, via their processor, coprocessor or TSX™ SCY 21601 communication module, several possible ways for exchanging data in character mode with devices equipped with an asynchronous serial link interface:

- RS 485 integrated port.
- Type III PCMCIA card with RS 232, RS 485 (RS 422 compatible) or 20 mA current loop link.

Protocols supported are character mode (ASCII), Uni-Telway™ and Modbus®. Other protocols are also available, or can be developed on request, on a RS 485 or RS 232 link, which enables TSX Micro/Premium PLCs to communicate on third-party architectures. The list of modules available can be obtained from your Schneider Electric Regional Sales Office, or from our Internet site [www.collaborativeautomation.com](http://www.collaborativeautomation.com).

### Description

#### Integrated links

- 1 Via integrated port on the processor or slot-PLC:  
The AUX (1) port (8-way mini-DIN connector) has one non-isolated RS 485 serial link channel (maximum distance 10 m).
- 2 Via integrated port on the TSX SCY 21601 module:  
This module for Premium PLCs has one isolated RS 485 serial link channel (25-way SUB-D connector). Half duplex multiprotocol, including Uni-Telway.

#### TSX™ SCP 11● multiprotocol PCMCIA cards

- 3 A slot on the processor, coprocessor and on the **TSX SCY 21601** module takes cards which are comprised of:
- 4 A removable cover with fixing screws for access to the 20-way miniature connector.
- 5 Two indicator lamps:
  - ERR lamp: detected card or link fault,
  - COM lamp: data transmission or reception.

To be ordered separately: **TSX SCP C●●●** cable.

(1) TER port for TSX Micro TSX 37 05/08/10 PLC.

### Characteristics

Type		Non isolated RS 485 terminal port	Isolated RS 485 TSX SCY 21601 integrated port (1)	PCMCIA card RS 232	PCMCIA card RS 485 RS 422 Compatible	PCMCIA card 20 mA current loop (3)	
Physical layer	Data rate	1.2...19.2 Kbit/s (2)	1.2...19.2 Kbit/s	0.3...19.2 Kbit/s	1.2...19.2 Kbit/s		
	Size	120 characters		4096 characters max.			
Transmission	Data	7 or 8 bits					
	Stop bit	1 or 2 bits					
	Parity bit	Even, odd or none					
	Stop on silence						
Services	Reception echo						
	Repeat 1 <sup>st</sup> char. echo						
	Auto LF						
	Back space						
	Beep						
	Flow mgmt	by Xon-Xoff					
		by RTS/CTS					
	RTS/CTS delay						
	Stop on reception						
	End of message						
PSR management							

Parameters which can be accessed in configuration mode.

(1) Half-duplex line in RS 485, Full-duplex in RS 422.

(2) With the **TSX P57 3●3M/4●3/3●4M** processor, data rate up to 115 Kbit/s during program uploading.

(3) Point-to-point or multidrop link.



TSX Micro

TSX SCY 21601  
Premium

TSX SCP 114



TSX PACC 01



TSX CUSB 485

### References

#### Asynchronous serial link elements (character mode)

Description	Protocol	Physical layer	PLC	Reference	Weight kg
<b>Integrated link on processor</b>	Character mode Uni-Telway™	RS 485 non-isolated	TSX Micro™ Premium™	Consult our site <a href="http://www.schneider-electric.com">www.schneider-electric.com</a> See pages 1/12 and 1/23	
<b>Communication module</b>	Character mode Uni-Telway Modbus®/Jbus	- 1 isolated RS 485 integrated channel (channel 0), - 1 PCMCIA card slot (channel 1) (1)	Premium	<b>TSX™ SCY 21601</b>	0.360
PCMCIA cards for TSX 37 21/22 PLC, Premium processor, TSX SCY 21601 module	Character mode Uni-Telway Modbus/Jbus	RS 232 (9 signaux) 0,3...19,2 Kbit/s		<b>TSX™ SCP 111</b>	0.105
		RS 485 (compatible RS 422) 1,2...19,2 Kbit/s		<b>TSX SCP 114</b>	0.105
		BC 20 mA 1,2...19,2 Kbit/s		<b>TSX SCP 112</b>	0.105

#### Asynchronous serial link connection accessories

Description	Use	Length	Reference	Weight kg
<b>Terminal port connection box</b>	Isolation of RS 485 signals, end of line adaptation Supplied with cable for connection to PLC	1 m	<b>TSX™ PACC 01</b>	0.690

#### Connecting cables for asynchronous serial links

Description	Use From	To	Length	Reference	Weight kg
<b>Cables for isolated RS 485 connection</b>	TSX SCP 114 card	RS 485/RS 422 device (2)	3 m	<b>TSX SCP CX 4030</b>	0.160
	Integrated channel (channel 0) TSX SCY 21601 module	RS 485/RS 422 device (3) via TSX SCA 50 box	3 m	<b>TSX™ SCY CU 6030</b>	0.180
<b>Universal cable for terminal port/RS 232 device</b>	TSX Micro/Premium/integrated port (TER or AUX) TSX PACC 01 box	RS 232 of a terminal device (DTE) (4)	2.5 m	<b>TSX™ PCX 1031</b>	0.170
		USB port of PC (USB/RS 485 converter)	0.4 m	<b>TSX™ CUSB 485</b> (5)	0.144
		USB port (mini-DIN/RJ45 cordset)	2.5 m	<b>TSX™ CRJMD 25</b> (5)	0.150
<b>Cables for RS 232 connection</b>	TSX SCP 111 card	Communication device: modem, converter, (DCE) (3)	3 m	<b>TSX SCP CC 1030</b>	0.190
		Point-to-point terminal device (DTE) (3)	3 m	<b>TSX SCP CD 1030</b>	0.190
			10 m	<b>TSX SCP CD 1100</b>	0.620
<b>Cable for BC 20 mA connection</b>	TSX SCP 112 card	Current loop device (2)	3 m	<b>TSX SCP CX 2030</b>	0.160

(1) PCMCIA type III slot can receive one TSX SCP 111/112/114 or TSX FPP 20 card.

(2) End of cable with flying leads.











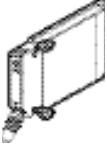

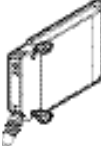
(3) End of cable fitted with a 25-way male SUB-D connector.

(4) End of cable fitted with a 9-way male SUB-D connector. For use, to order separately one TSX CTC 10 adaptor (9-way male SUB-D connector/25-way male SUB-D connectors).

(5) With TSX CUSB 485 converter, use the TSX CRJMD 25 cordset (equipped with 1 x mini-DIN and 1 x RJ45).

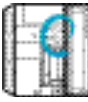
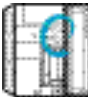
# Modicon® Premium™ automation platform

## Connecting cables for PCMCIA cards and TER/AUX ports

TSX Micro™/Premium™ PLC	Device to be connected	Physical link	Protocol	Length	Reference	Weight kg
<b>TSX SCP 111 PCMCIA card</b> 	DTE terminal <b>2</b>	RS 232D	Character mode	3 m 10 m	<b>TSX™ SCP CD 1030</b> <b>TSX SCP CD 1100</b>	0.190 0.620
						
	DCE terminal (Modem...) <b>2</b>	RS 232D	Character mode Uni-Telway™	3 m	<b>TSX SCP CC 1030</b>	0.190
						
<b>TSX SCP 114 PCMCIA card</b> 	TSX SCA 50 T-junction box <b>3</b>	RS 485 (2-wire isolated)	Character mode Uni-Telway	3 m	<b>TSX SCP CU 4030</b>	0.160
						
	TSX SCA 422/485	RS 422/485 (2-wire isolated)	Character mode Modbus	3 m	<b>TSX SCP CM 4030</b>	0.160
						
	TSX SCA 62 2-channel subscriber socket <b>4</b>	RS 485 (2-wire isolated)	Uni-Telway	3 m	<b>TSX SCP CU 4530</b>	0.160
						
TSX SCA 64 2-channel subscriber socket <b>4</b>	RS 422/485 (2/4 wire)	Modbus®	3 m	<b>TSX SCP CM 4530</b>	0.180	
						
	DTE Terminal <b>3</b>	RS 422/485 (4-wire)	Modbus	3 m	<b>TSX SCP CX 4030</b>	0.160
						
<b>TSX SCP 112 PCMCIA card</b> 	Active or passive terminal <b>3</b>	20 mA current loop	Character mode Uni-Telway™ Modbus®	3 m	<b>TSX SCP CX 2030</b>	0.160
						
<b>TER/AUX ports</b> 	TSX P ACC 01 junction box <b>1</b>	RS 485	Uni-Telway	1 m	Included with TSX P ACC 01	
						
	TSX P ACC 01 junction box <b>5</b>	RS 485	Uni-Telway	2 m 5 m	<b>T FTX CB1 020</b> <b>T FTX CB1 050</b>	0.100 0.190
						
	DTE terminal (PC, printer) <b>6</b>	RS 232	Character mode	2,5 m	<b>TSX PCX 1031 (1)</b>	0.170
						
		RS 232	Character mode	0,4 m 2,5 m	<b>TSX CUSB 485 (2)</b> <b>TSX CRJMD 25 (2)</b>	0,144 0.150

- 1 25-way male miniature connector.
- 2 25-way male SUB-D connector.
- 3 Flying leads.
- 4 15-way male SUB-D connector.
- 5 8-way female mini-DIN connector.
- 6 9-way female SUB-D connector



(1) Separate parts see page 5/111 of this catalog.

(2) The **TSX CUSB 485** requires to use with the **TSX CRJMD 25** cordset (equipped to mini-DIN connector and RJ45 connector).

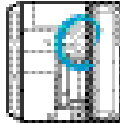

# Modicon® Premium™ automation platform

## Connecting cables for PCMCIA cards and TER/AUX ports

TSX Micro™/Premium™ PLC	Device to be connected	Physical link	Protocol	Length	Reference	Weight kg	
 TER/AUX ports (contin.)	DTE terminal (slave PC) <sup>2</sup>	RS 232	Uni-Telway™	2.5 m	<b>TSX™ PCX 1031</b>	0.170	
		RS 485					
			USB	Uni-Telway	0,4 m	<b>TSX™ CUSB 485 (1)</b>	0,144
			2,5 m			<b>TSX™ CRJMD 25 (1)</b>	0.150
	DTE terminal (printer, slave PC without RTS)		RS 232	Character mode Uni-Telway	2.5 m	<b>TSX PCX 1031 (2)</b>	0.170
			<sup>2</sup> RS 232	Character mode Uni-Telway	0,4 m	<b>TSX CUSB 485 (1)</b>	0,144
			2,5 m		<b>TSX CRJMD 25 (1)</b>	0.150	
	DCE terminal (Modem M/Sl. USA/Europe) <sup>4</sup>	RS 232	Character mode Uni-Telway	3 m	<b>TSX PCX 1130 (3)</b>	0.140	
	Magelis® XBT GTP terminal <sup>3</sup>		RS 485	Uni-Telway	2,5 m	<b>XBT™ Z968 + XBT ZG909 (4)</b>	0,180
					5 m	<b>XBT Z9681 + XBT ZG909 (4)</b>	0,340
 TSX™ SCY 21601 communication module integrated port <sup>5</sup>	TSX SCA 50 T-junction box <sup>5</sup> (2-wire isolated)	RS 485	Uni-Telway	3 m	<b>TSX™ SCY CU 6030</b>	0.180	
			Modbus®	3 m	<b>TSX SCY CM 6030</b>	0.180	
	TSX SCA 62 2-channel subscriber socket <sup>6</sup>		RS 485 (2-wire isolated)	Uni-Telway	3 m	<b>TSX SCY CU 6530</b>	0.200
	RS 485 terminal <sup>5</sup>	RS 485 (2-wire isolated)	Character mode	3 m	<b>TSX SCY CM 6030</b>	0.180	

Separate parts			
Description	Description	Reference	Weight kg
SUB-D adapter	9-way male SUB-D connector/25-way female SUB-D connectors	<b>TSX CTC 07</b>	0.060
	9-way male SUB-D connector/25-way male SUB-D connector	<b>TSX CTC 10</b>	0.060

- <sup>1</sup> 8-way female mini-DIN connector.
- <sup>2</sup> 9-way female SUB-D connector.
- <sup>3</sup> 9-way male SUB-D connector.
- <sup>4</sup> 25-way male SUB-D connector
- <sup>5</sup> Flying leads.
- <sup>6</sup> 15-way male SUB-D connector

- (1) The **TSX CUSB 485** requires to use with the **TSX CRJMD 25** cordset (equipped to mini-DIN connector and RJ45 connector).
- (2) To be ordered separately: **TSX CTC 07** and **TSX CTC 10** adapters, see above separate parts.
- (3) Point to point, supplied with 1 SUB-D adapter: **TSX CTC 09** 9-way female/25-way male SUB-D connector.
- (4) For connection to Magelis XBT GK/GW, consult our catalog "Human/Machine Interfaces."



**6.1 - Unity™ software**

**Selection guide: Unity™ Pro** ..... 6/2

- Unity™ Pro software
  - Presentation, setup ..... 6/6
  - Software structure ..... 6/11
  - Five IEC languages ..... 6/14
  - Functions / function blocks ..... 6/20
  - Unity™ Pro XLS specific functions ..... 6/30
  - References ..... 6/35
- Unity™ EFB Toolkit software ..... 6/40
- Unity™ SFC View software ..... 6/42
- Unity™ Dif application comparison software ..... 6/46
- Unity™ Application Generator (UAG)
  - Presentation ..... 6/48
- Process control
  - Presentation ..... 6/52
  - User-definable process control ..... 6/53
  - Programmable process control ..... 6/58

**6.2 - PL7™ software**

**Selection guide: PL7™** ..... 6/60

- PL7™ Micro/Junior/Pro software
  - Presentation ..... 6/62
  - Software structure ..... 6/65
  - Four languages ..... 6/67
  - Functions ..... 6/69
  - References ..... 6/75
- SDKC software ..... 6/78
- PL7™ FUZ software for fuzzy logic processing ..... 6/80
- PL7™ DIF application comparison software ..... 6/82
- Process control
  - Presentation (user-definable control loops) ..... 6/84
  - Functions ..... 6/85

**6.3 - Vijeo® Citect® supervisory software**

- Presentation ..... 6/90
- Architectures ..... 6/92
- References ..... 6/94

**6.4 - OPC Factory Server (OFS)™ software**

- Presentation ..... 6/100
- Software ..... 6/101
- Set up ..... 6/103
- Functions ..... 6/104
- References ..... 6/105



Unity™ Pro programming software for Modicon® Premium™ P, M340™ M, Quantum™ Q SIL-rated Quantum™ S



6



<b>IEC 61131-3 languages</b>	Instruction List (IL)	M	M - P
	Ladder (LD)	M	M - P
	Structured Text (ST)	M	M - P
	Function Block Diagram (FBD)	M	M - P
	Sequential Function Chart (SFC)/Grafcet™	M	M - P
<b>Programming services</b>	Multi-task programming (Master, fast and event-triggered)	M	M - P
	Multi-task programming (Master, fast, auxiliary and event-triggered)		
	Functional view and function modules	M	M - P
	Block editor and DFB instances	M	M - P
	DDT compound data editor	M	M - P
	Data structure instances and tables	M	M - P
	EF function block libraries and EFB function blocks	M	M - P
	User-definable control loops		P (TSX P57 2●)
	Programmable control loops (with process control FB library)	M	M - P
	Safety function block library		
	Motion function block libraries (MFB)	M	M - P
	Hot Standby PLC redundancy system		P (TSX H57 24M)
	System diagnostics	M	M - P
	Application diagnostics	M	M - P
	Diagnostics with location of detected error source	M	M - P
<b>Debugging and display services</b>	PLC simulator	M	M - P
	Hypertext link animations in graphic languages	M	M - P
	Step by step execution, breakpoint	M	M - P
	Watchpoint	M	M - P
	Operator screens	M	M - P
	Diagnostic viewer	M	M - P
<b>Other services</b>	Creation of hyperlinks	M	M - P
	XML import/export	M	M - P
	Application converters (Concept™, PL7™)		M - P
	Utilities for updating PLC operating systems	M	M - P
	Communicating drivers for Windows 2000/XP®	M	M - P
	Unity Pro servers - Openness		
<b>UDE support</b>	Dynamic exchange with 3rd party tools, OFS		
<b>OFS exchanges</b>	Static exchange via XML/XVM export files	M	M - P
<b>Compatible Modicon platforms</b>	Modicon® M340™ processors M	BMX P34 1000 BMX P34 20●0	BMX P34 1000 BMX P34 20●0
	Premium™ CPUs P	-	TSX™ P57 C● 0244/0244M TSX P57 104/1634/154M TSX P57 204/2634/254M TSX H57 24M
	Quantum™ CPUs Q	-	-
	SIL-rated CPUs S	-	-
<b>Software name</b>		<b>Unity Pro Small</b>	<b>Unity Pro Medium</b>
<b>Unity Pro software type</b>		<b>UNY SPU SF● CD40</b>	<b>UNY SPU MF● CD40</b>
<b>Pages</b>		6/36	

M - P - Q	M - P - Q	M - P - Q
M - P - Q	M - P - Q	M - P - Q - S
M - P - Q	M - P - Q	M - P - Q
M - P - Q	M - P - Q	M - P - Q - S
M - P - Q	M - P - Q	M - P - Q
M - P - Q	M - P - Q	M - P - Q
	P (TSX P57 5●) - Q (140 CPU 651/671)	P (TSX P57 5●) - Q (140 CPU 651/671)
M - P - Q	M - P - Q	M - P - Q - S
M - P - Q	M - P - Q	M - P - Q
M - P - Q	M - P - Q	M - P - Q
M - P - Q	M - P - Q	M - P - Q
M - P - Q	M - P - Q	M - P - Q
P (TSX P57 2●/3●/4●)	P (TSX P57 2●/3●/4●/5●)	P (TSX P57 2●/3●/4●/5●)
M - P - Q	M - P - Q	M - P - Q
		S
M - P	M - P	M - P
P (TSX H57 24/44M)	P (TSX H57 24/44M) - Q (140 CPU 67 160)	P (TSX H57 24/44M) - Q (140 CPU 67 160) - S
M - P - Q	M - P - Q	M - P - Q - S
M - P - Q	M - P - Q	M - P - Q
M - P - Q	M - P - Q	M - P - Q
M - P - Q	M - P - Q	M - P - Q - S
M - P - Q	M - P - Q	M - P - Q - S
M - P - Q	M - P - Q	M - P - Q - S
M - P - Q	M - P - Q	M - P - Q - S
M - P - Q	M - P - Q	M - P - Q - S
M - P - Q	M - P - Q	M - P - Q - S
M - P - Q	M - P - Q	M - P - Q - S
M - P - Q	M - P - Q	M - P - Q
M - P - Q	M - P - Q	M - P - Q
M - P - Q	M - P - Q	M - P - Q - S
	M - P - Q	M - P - Q - S
	M - P - Q	M - P - Q - S
M - P - Q	M - P - Q	M - P - Q - S
BMX P34 1000 BMX P34 20●0	BMX P34 1000 BMX P34 20●0	BMX P34 1000 BMX P34 20●0
TSX™ P57 C● 0244/0244M TSX P57 104/1634/154M TSX P57 204/2634/254M TSX P57 304/3634/354M TSX P57 4634/454M TSX™ H57 24/44M	TSX P57 C● 0244/0244M TSX P57 104/1634/154M TSX P57 204/2634/254M TSX P57 304/3634/354M TSX P57 4634/454M TSX P57 5634/554M TSX P57 6634M TSX H57 24/44M	TSX P57 C● 0244/0244M TSX P57 104/1634/154M TSX P57 204/2634/254M TSX P57 304/3634/354M TSX P57 4634/454M TSX P57 5634/554M TSX P57 6634M TSX H57 24/44M
140 CPU 311 10 140 CPU 434 12U	140 CPU 311 10 140 CPU 434 12U 140 CPU 651 50/60 140 CPU 652 60 140 CPU 671 60	140 CPU 311 10 140 CPU 434 12U 140 CPU 651 50/60 140 CPU 652 60 140 CPU 671 60
-	-	140 CPU 651 60S 140 CPU 671 60S
<b>Unity Pro Large</b>	<b>Unity Pro Extra Large</b>	<b>Unity Pro XLS</b>
<b>UNY SPU LF● CD40</b>	<b>UNY SPU EF● CD40</b>	<b>UNY SPU XF● CD31</b>

# Modicon® Premium™ automation platform

## Unity™ Pro software

S / M / L / XL / XLS

	EF/EFB function development software in C language	SFC View application diagnostic and monitoring software
		
<p><b>Services</b></p>	<p>Enhancement of EF and EFB function block libraries:</p> <ul style="list-style-type: none"> <li>■ Creation of families</li> <li>■ Development of functions in C language</li> <li>■ Access to data and variable types</li> <li>■ Debugging functions (step by step, breakpoint)</li> <li>■ Use of created functions</li> </ul> <p>Supplied with:</p> <ul style="list-style-type: none"> <li>■ Microsoft Visual C++®</li> <li>■ GNU source code and compiler</li> </ul>	<p>ActiveX® control component for monitoring and diagnostics of chart status (SFC or Grafcet™) in sequential applications:</p> <ul style="list-style-type: none"> <li>■ Overview of charts and detailed views</li> <li>■ Can be integrated in human/machine interface (HMI) applications</li> <li>■ Access to PLC data via OFS (OPC Factory Server)</li> </ul> <p>Includes EFB function block library for Unity™ Pro (for Modicon® Premium™, M340™ and Quantum™ CPUs)</p>
<p><b>Compatibility</b></p>	<p><b>Software:</b> Unity™ Pro Small, Medium, Large and Extra Large</p> <p><b>CPUs:</b></p> <ul style="list-style-type: none"> <li>■ Modicon® M340™</li> <li>■ Premium™ Unity™</li> <li>■ Quantum™ Unity™</li> </ul>	<p><b>Software:</b> Unity Pro Extra Large</p> <p><b>CPUs:</b></p> <ul style="list-style-type: none"> <li>■ Modicon M340</li> <li>■ Premium Unity</li> <li>■ Quantum Unity</li> </ul>
<p><b>Software name</b></p>	<p>Unity EFB Toolkit</p>	<p>Unity SFC View</p>
<p><b>Unity Pro software type</b></p>	<p>UNY SPU ZFU CD30E</p>	<p>UNY SDU MF• CD20</p>
<p><b>Pages</b></p>	<p>6/41</p>	<p>6/45</p>

Comparison software for Unity™ Pro applications	Software for loading application and firmware components	Software for designing and generating batch/process applications	Pack for developing specific solutions
---	--	--	--



Automatic comparison of 2 Modicon® Premium™, M340™ and Quantum™ applications with identification of differences.

Simple and easy to use software to upgrade a Modicon M340 CPU when the user doesn't need to display/modify the application.

UAG specialist software for designing and generating batch/process applications in a "Collaborative Automation" environment.

Specialist software for developing made-to-order solutions (for example interfaces with an electrical CAD system, automatic application generator, etc):

- Upload/download:
- CPU and Ethernet module firmware
  - PLC project, including:
    - Program
    - Located and unlocated data
    - User files and user web pages

- It provides the unique project database:
- Process and control (PLCs)
  - HMI user interface (Magelis®)
  - SCADA supervision (Vijeo™ Citect®)
- Based around re-usable objects (PID, valves, etc) and complying with standard ISA S88, UAG generates the PLC code and the elements required for the HMI system. Complies with the GAMP standard (*Good Automation Manufacturing Practice*)

- Access to Unity Pro object servers
- Reserved for IT development engineers using Visual Basic® or C++®

**Software:**  
Unity™ Pro Extra Large

**CPUs:**

- Modicon® Premium™
- Quantum™
- M340™

**Software:**  
Unity Pro Small, Medium, Large and Extra Large

**CPUs:**  
Modicon M340

**Software:**  
Unity Pro Extra Large

**CPUs:**

- Premium Unity:
  - TSX™ P57 4634/454M
  - TSX P57 5634/554M
  - TSX P57 6634M
- Quantum Unity

**Software:**  
Unity Pro Extra Large

**CPUs:**

- Modicon® Premium™
- Quantum™
- M340™

Unity Dif	Unity Loader	Unity Application Generator	Unity Developer's Edition
<b>UNY SDU DFU CD20</b>	<b>UNY SMU ZU CD20</b>	<b>UNY SEW LF CD30</b>	<b>UNY UDE VFU CD21E</b>
6/47	–	6/51	6/34

#### User interface

The Unity™ Pro welcome screen provides access to all available tools in a user-friendly format that has been redesigned on the basis of feedback received from users of Concept™ and PL7™ Junior/Pro application design software.

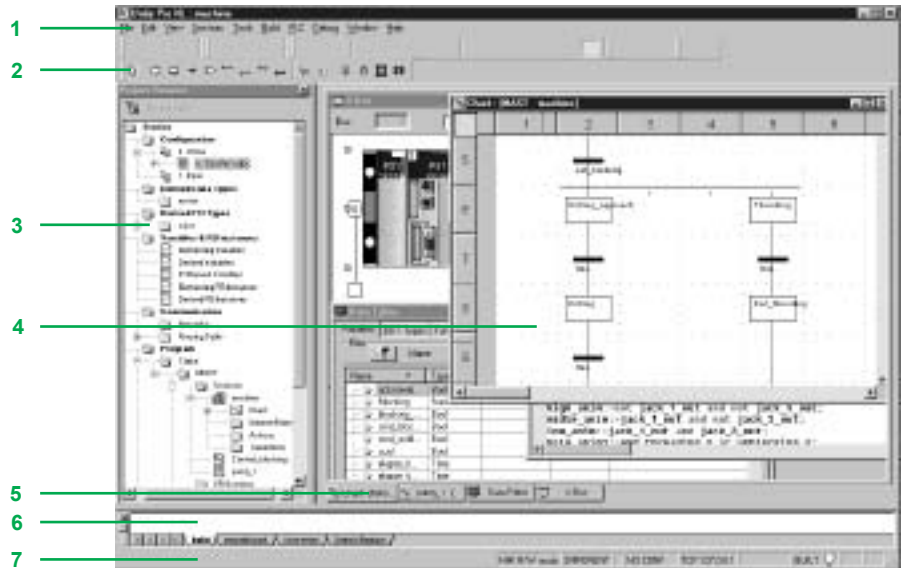

This welcome screen consists of a general view made up of a number of windows and toolbars, which can be arranged as required on the screen:

- 1 Menu bar from which all functions can be accessed
- 2 Toolbar consisting of icons from which the most frequently used functions can be accessed
- 3 Application browser, which can be used to browse the application based on a conventional and/or a functional view
- 4 Editor windows area, which can be used to view a number of editors at the same time (configuration editor, Structured Text/Ladder etc. language editors, data editor)
- 5 Tabs for direct access to editor windows
- 6 Information window with tabs (User Errors, Import/Export, Search/Replace, etc.)
- 7 Status bar

#### Accessing functions

All functions can be accessed via drop-down menus from the menu bar. The toolbar, which consists of icons, provides faster access to the most frequently used functions. This toolbar, which is displayed by default, can be customized to meet the requirements associated with the various uses of Unity Pro software and is divided into three groups:

- Main toolbars, which are always displayed
- Contextual toolbar, which is displayed when the corresponding editor is selected
- Toolbar with zoom functions (in and out), full-screen view for editor window

They are classified according to the category of functions available:

- File management (New Project, Open, Save, Print)
- Edit (Undo, Redo, Confirm, Go To)
- Application services (Analyse Project, Build Project, Browse, Find, Access Library)
- Automation platform operating mode (Upload/Download Project, Online/Offline, Run/Stop, Animate, PLC/Simulation Mode)
- Debug mode (Set/Remove Breakpoint, etc.)
- Window display (Cascade, Horizontal, Vertical)
- Online help (non-contextual or contextual)



"File/Edit" toolbar

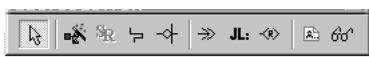

FBD language editor contextual toolbar



"PLC" toolbar for debug mode



Toolbar with zoom (in and out)



#### Project navigator

The project browser can be used:

- To display the content of a Modicon® Premium™, Quantum™ or M340™ PLC project
- To move between the different components of the application (configuration, program, variables, communication, DFB user function blocks, DDT derived function blocks) created by the user

The project can be displayed using two view types:

■ **Structural view**, which provides an overall view of the various components of the application. This representation provides a view of the order in which the program sections are processed in the PLC.

■ **Functional view**, which provides a view of the project based on specific function modules. This representation provides a breakdown according to consistent functions in relation to the process to be controlled. These two view types, which are available at any time, can be displayed separately or at the same time (with horizontal or vertical windows) by clicking on the icons on the toolbar.

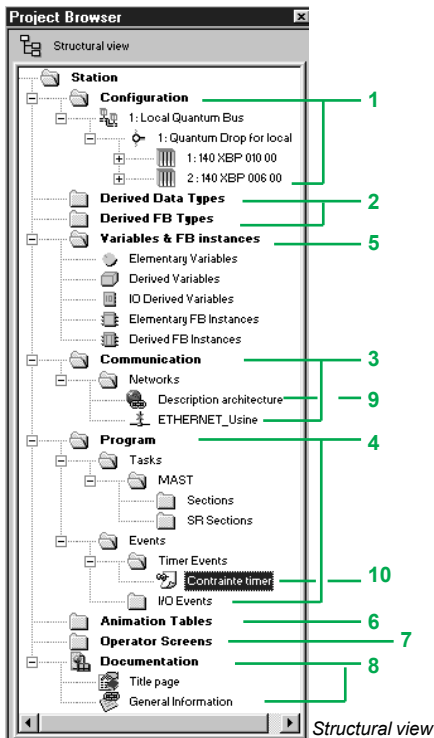

Structural view



Functional view

#### Structural view

This conventional view allows you to access the different components of the application (configuration, programming, function blocks, debugging, etc.) via the application browser.

The browser gives an overall view of the program and offers fast access to application components.

- 1 Configuration editor
- 2 DFB (user function block) and DDT (Derived Data Type) editors
- 3 Communication networks editor
- 4 Program editor
- 5 Variables editor
- 6 Animation tables editor
- 7 Runtime screens editor
- 8 Documentation editor

From any level in the tree structure, you can:

- 9 Create a hyperlink to a comment or description
  - 10 Create a directory for storing hyperlinks used to access a set of user folders
- From this level, it is also possible to zoom in and only view the details for a component on this level.

#### Functional view

Unity™ Pro software applications support the creation of an application structure for Modicon M340, Premium, and Quantum platforms based on function modules comprising:

- Sections (program code)
- Animation tables
- Runtime screens

The designer can define a multi-level tree structure for the application, independently of the multi-task structure of the PLC.

Program sections written in Ladder (LD), Structured Text (ST), Instruction List (IL), Function Block Diagram (FBD), or Sequential Function Chart (SFC) language can be associated with each level, along with animation tables and runtime screens

#### Exporting/importing function modules

The tree structure, or a portion of it, can be exported to functional modules. In this case, program sections on the various module levels are exported.

Utilities make it easy to reuse these modules in new applications by means of data and module name reassignment services.

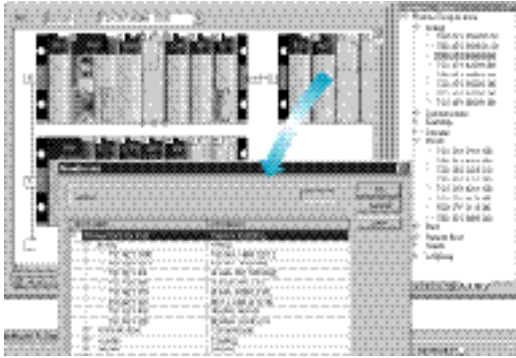

Hardware configuration

### Configuration editor

#### Hardware configuration

The first step when creating an automation project based on a Modicon® Premium™, M340™ or Quantum™ platform is to select the processor for which a rack and power supply are defined by default.

The configuration editor supports the intuitive and graphics-based modification and extension of this configuration with the following elements:

- Racks, power supply
- PCMCIA memory or communication cards (Premium) on the processor
- Discrete I/O, analog I/O, or application-specific modules

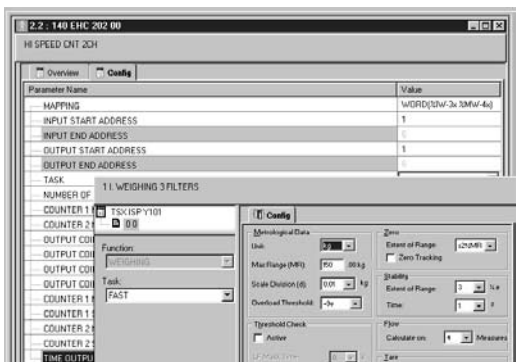

I/O module parameter setting

#### Configuration and parameter settings for I/O and application-specific modules

From the configuration screen for Modicon Premium, M340 or Quantum racks, the parameters screen displayed for a specific module can be used to define the operating characteristics and parameters for the selected application, for example:

- Filter values for discrete I/O
- Voltage or current range for analog I/O
- Threshold counter values
- Trajectory of axes for position control
- Weigher calibration for weighing
- Transmission speed for communication
- Pre-symbolization for variables associated with modules



"Communication" folder with 2 networks declared

#### Configuration and parameter settings for communication networks

The "Communication" folder in the structural view can be used to define the list of networks connected to the PLC station. Then, the parameters for elements required for networks to function correctly can be set by:

- Creating a logical network to which comments can be associated
- Configuring a logical network defining the various associated network services

Once the network module has been created in the configuration, it must then be associated with one of the logical networks.

Ethernet Modbus®/TCP, Modbus Plus™, and Fipway® network modules are configured in this way.

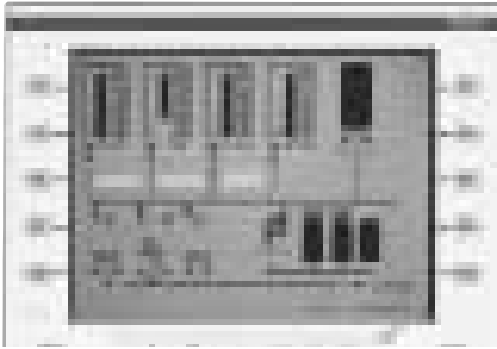

Power supply requirements analysis

### Configuration editor (continued)

#### Configuration check

The following information can be accessed at any time during configuration:

- The power consumption statistics for the power supply in each of the racks in the PLC configuration, for the different voltages provided by each of these power supplies
- The number of inputs/outputs configured (with Modicon® Premium™, Quantum™ or M340™ platform)



Graphical configuration of devices on CANopen bus

#### Configuration of CANopen devices

In the same way as for in-rack modules, the configuration of devices on CANopen through a Modicon M340 processor is fully integrated into the configuration editor.



"Data & Languages" tab in the workstation options

### Workstation and project configuration

Unity™ Pro can be used to configure both the working environment (workstation options) and the content of the project itself.

It is also possible to configure the toolbars and to run third-party applications from Unity Pro.

In addition, users can choose the working language from the list of languages selected when the software was installed.

#### Workstation options

The workstation options cover the characteristics specific to a given workstation. They are applied when Unity Pro is used to develop any project on that station.

The following elements can be configured:

- The way information is edited and presented in the project being developed (for example: whether or not coils are positioned in the last column of the editor, or the position of the cursor after confirmation of the information entered)
- The application conversion strategy from PL7™, Concept™ IEC, and LL984 language
- The function library path
- The opening mode for Unity Pro: either programming or run mode

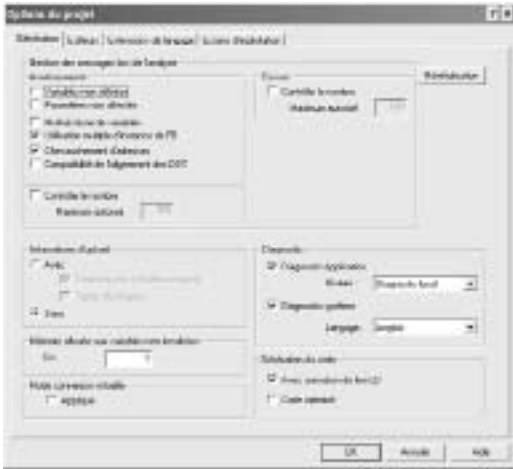

"Language extensions" tab in the workstation option



User-created toolbar containing the debugging tools

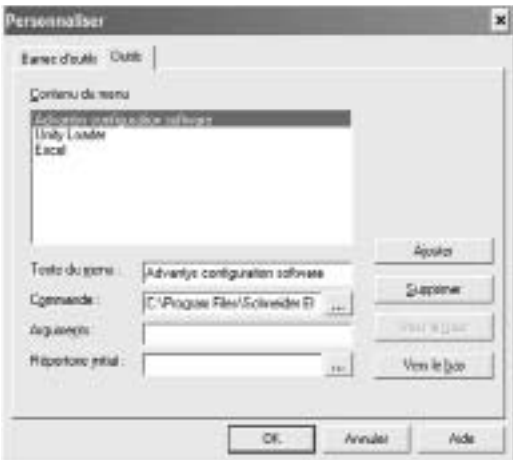

Menu for adding and deleting tool access from Unity Pro

### Workstation and project configuration (continued)

#### Project options

In contrast to the workstation options, project options cover characteristics that have a direct impact on the programming and execution capacities offered by the program in the PLC. They are saved in the application, and consequently, are attached to the project. They can be modified during the course of the project.

Project option configuration is comprised of the following elements:

- Project generation with the information enabling the project to be retrieved on a new terminal
- Use of diagnostic functions and language for messages
- Warnings generated during project analysis: overlapping of addresses, unused variables, etc.
- Language extension: If none of the boxes is checked, the program is strictly compliant with IEC 61131-3. Extensions are possible in the five Unity™ Pro languages.
- Access management to runtime screens in online mode.

#### Other possible options

Users can create their own toolbars by reusing the default icons provided on the toolbars.

It is also possible to enhance the main Unity Pro menu bar by adding direct links to other software tools.

A utility in the Unity Pro program group can be used to change the working language. The change will take effect the next time the software is launched. Six languages are available: English, German, Spanish, French, Italian, and Chinese.

#### Software structure

The Modicon® Premium™, M340™ and Quantum™ platforms implemented by Unity™ Pro software support two types of application structure:

- **Single-task:** This is the more simple default structure, in which only the master task is executed.
- **Multi-task:** This structure is more suitable for high-performance real-time events and consists of a master task, a fast task, periodic tasks, and high-priority event-triggered tasks.

The master, fast, and periodic tasks are made up of sections and subroutines. These sections and subroutines can be programmed in any of the following languages: Structured Text (ST), Instruction List (IL), Ladder (LD) or Function Block Diagram (FBD). The event-triggered tasks use the same languages. Sequential Function Chart (SFC) or Grafset™ language is reserved for master task sections.

The table below lists the possible program tasks for Modicon M340, Premium™ and Quantum type processors, respectively.

Platform	Modicon® M340™		Premium™			Quantum™	
	BMX P34 1000	BMX P34 2000	TSX™ P 57 0244M TSX P 57 104M	TSX P 57 20(3)4M TSX P 57 30(3)4M TSX P 57 40(3)4M	TSX P 57 554M TSX P 57 5634M TSX P 57 6634M	140 CPU 31110 140 CPU 434 12U	140 CPU 651 00 140 CPU 671 60
Cyclic or periodic master task	Yes	Yes	Yes	Yes	Yes	Yes	Yes
Periodic fast task	Yes	Yes	Yes	Yes	Yes	Yes	Yes
Periodic auxiliary tasks	–	–	–	–	4	–	4
<b>Event-triggered tasks</b>							
From modules	32	64	32	64	128	64	128
From timers	32	64	–	–	32	16	32
Total	32	64	32	64	128	64	128

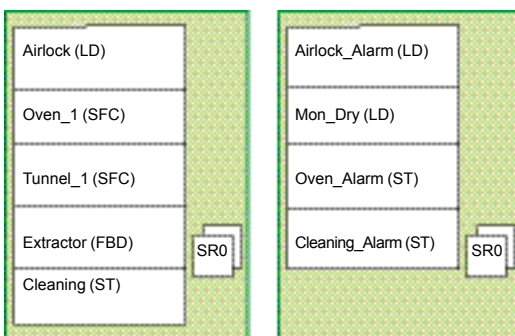

Master task

Fast task

#### Structure, modular, and portable programming

The tasks of a Unity™ Pro program for Modicon® M340™, Premium™, or Quantum™ platforms are composed of several parts called sections and subroutines. Each of these sections can be programmed in the most appropriate language for the process to be executed.

Such division into sections enables a structured program to be created and program modules to be generated or added with ease.

Subroutines can be called from any section of the task to which they belong or from other subroutines in the same task.

**Compatibility of languages compliant with IEC standard 61131-3:** Unity Pro software can be configured (*Tools/Project Settings/Language Extensions menu*) to help ensure that applications generated are compliant with IEC standard 61131-3. Furthermore, as long as you use only the standard instruction libraries, you will be able to reuse programs created in this way on any Modicon M340, Premium or Quantum platform.

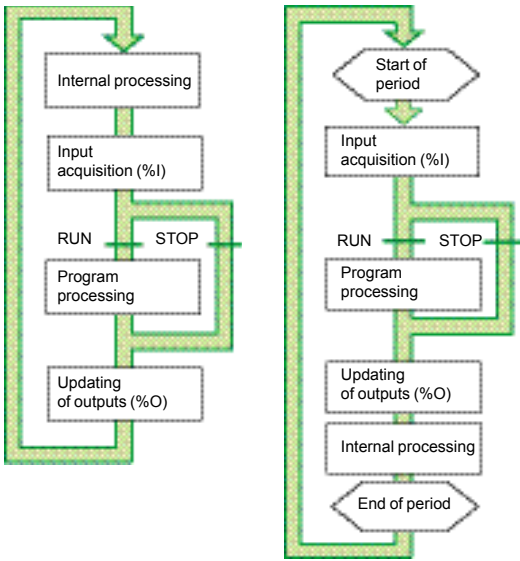

Cyclic execution

Periodic execution

### Single-task software structure

Two types of cyclic execution are supported:

- Normal cyclic execution. This is the default option.
- Periodic execution. This type of execution, as well as the period, are selected by the user during programming when the task parameters are set (Mast task).

#### Normal execution (cyclic)

At the end of each scan, the PLC system launches a new scan. The execution time of each scan is monitored by a software watchdog whose value is defined by the user (1,500 ms, maximum).

In the event of an overrun, a detected fault will cause:

- The scan to stop immediately (STOP)
- Status to be displayed on the front panel of the processor
- The alarm relay for the main rack power supply to be set to 0

#### Periodic execution

A new scan is executed at the end of each period. The execution time of the scan must be less than the time of the period defined (255 ms, maximum). In the event of an overrun, the latter is stored in a system bit (%S19), which can be reset to 0 by the user (via the program or terminal).

A software watchdog, which can be configured by the user (1,500 ms, maximum), monitors the scan time. In the event of an overrun, a detected execution fault is indicated (see Normal execution). The scan execution times (the last scan, the longest scan, and the shortest scan) are stored in system words %SW 30/31/32.

### Multi-task software structure

Modicon® Premium™, M340™ and Quantum™ platforms support a multi-task structure comprised of:

- 1 master task (divided into several sections programmed in ST, IL, LD, FBD, and SFC languages)
- 1 fast task (divided into sections)
- 0 to 4 auxiliary tasks (divided into sections) (1).
- 1 or more event-triggered tasks (only one section per task). These tasks are independent and executed in parallel, with the PLC processor managing their execution priority. When an event occurs, or at the start of the fast task scan:
- If any lower-priority tasks are currently being executed, they are suspended.
- The event-triggered task or fast task is executed.
- The interrupted task resumes once execution of the priority task has been completed.

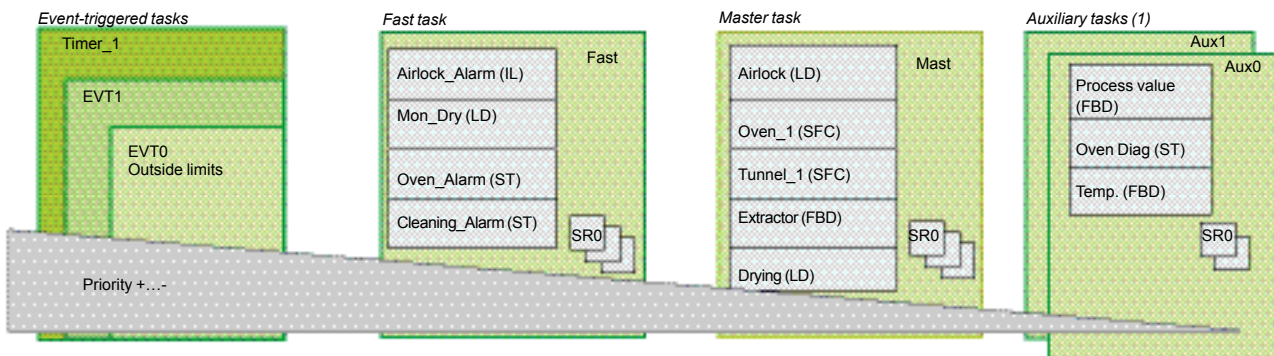

This structure optimizes the way processing power is employed and can be used to structure the application and simplify design and debugging, as each task can be written and debugged independently of the others.

(1) Tasks reserved for Premium TSX P57 5•4M/6634M and Quantum 140 CPU 651 •0/67160 high-end processors.

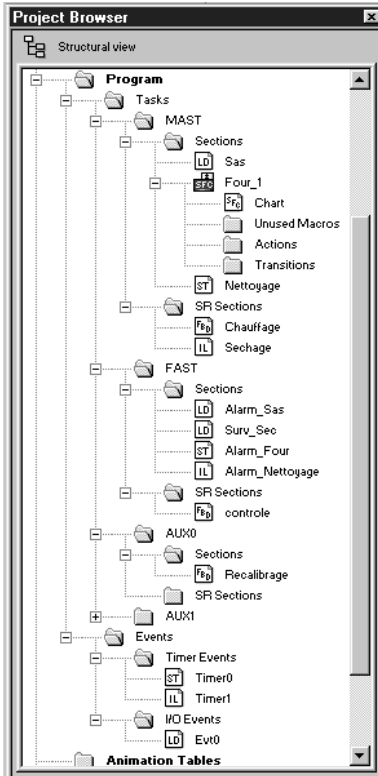

Application browser

#### Multi-task software structure (continued)

##### Master task

This task, which can be periodic or cyclic, executes the main program. It is activated systematically. Each of its component sections and subroutines can be programmed in Ladder (LD), Function Block Diagram (FBD), Structured Text (ST), or Instruction List (IL) language. Several sections of the master task can be programmed in Sequential Function Chart (SFC) or Grafcet language.

##### Fast task

This task, which has a higher priority than the master task, is periodic in order to allow time for tasks with lower priorities to be executed. It should be used when fast periodic changes in discrete inputs need to be monitored and taken into account. The execution of the master task (lower priority) is suspended while the fast task is being executed. Processing operations in this task must be as short as possible in order to avoid adversely affecting master task processing operations. Each section and subroutine of the fast task can be programmed in Instruction List, Structured Text, Ladder, or Function Block Diagram language (IL, ST, LD, or FBD).

##### Auxiliary tasks

These tasks, which are available with the Premium™ and Quantum™ **TSX™ P57 5•4M/6634M and 140 CPU 651 •0/652 60/671 60** high-end processors are intended for slower processing operations, such as measurement, process control, HMI, application diagnostics, etc.

Periodic type auxiliary tasks have the lowest priority and are executed once the higher-priority periodic tasks (master and fast) have completed their scan. Each subroutine or section of an auxiliary task can be programmed in Instruction List, Structured Text, Ladder, or Function Block Diagram language (IL, ST, LD, or FBD).

##### Event-triggered tasks

Unlike the tasks described above, these tasks are not linked to one period.

The asynchronous execution of these tasks is triggered by:

An event from certain application-specific modules (for example: overrun of a counter threshold, change of state of a discrete input)

An event from the event timers.

These tasks are processed with priority over other tasks and are thus suitable for processing requiring very short response times in comparison to the arrival of the event.

Modicon® Premium™, M340™ and Quantum™ platforms have 3 priority levels (these are, in descending order, EVT0 module event, EVTi module events, and Timeri timer events).

These tasks, each comprising a single section, can be programmed in Instruction List, Structured Text, Ladder, or Function Block Diagram language (IL, ST, LD or FBD).

##### Assignment of I/O channels to tasks

The master, fast, and event-triggered tasks read (at the start of the scan) and write to (at the end of the scan) the inputs/outputs assigned to them. By default, they are assigned to the master task.

For the Quantum platform, the remote inputs/outputs (RIO) are assigned only to the master task (these assignments can be made per station or for each of the component sections of the task); the distributed inputs/outputs (DIO) are assigned to the master task (with no assignment to its component task).

For event-triggered tasks, it is possible to assign input/output channels (1) other than those relating to the event. Exchanges are then performed implicitly at the start of processing for inputs and at the end of processing for outputs.

(1) These channel assignments are made per I/O modules for Quantum and per channel for Premium inputs/outputs.

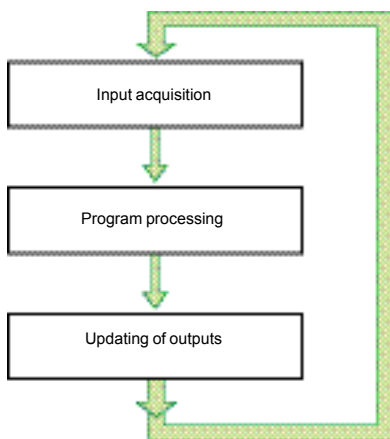

Program execution

#### Five IEC languages available

The five graphical or textual languages available in Unity™ Pro software are used for programming Modicon® Premium™, M340™ and Quantum™ automation platforms.

The 3 graphical languages are:

- Ladder (LD)
- Function Block Diagram (FBD)
- Sequential Function Chart (SFC) or Grafcet™

The 2 textual languages are:

- Structured Text (ST)
- Instruction List (IL)

For these 5 languages, you can use the standard set of instructions compliant with IEC standard 61131-3 to create applications that can be transferred from one platform to another. Unity™ Pro software also provides extensions to this standard set of instructions. As they are specific to Modicon M340, Premium, and Quantum PLCs, these extensions support the development of more complex applications in order to maximize the potential of the specific features of each of these platforms.

#### Functionalities common to the five language editors

The editors for each of the 5 languages provide a number of common tools used for writing, reading, and analyzing programs in a user-friendly manner:

■ The text editors for Instruction List (IL) and Structured Text (ST) languages feature:

- Text entry in insert or overwrite mode
- The use of dialog boxes for the assisted entry of variables, functions, function blocks, or assignment instructions
- Checks on data entry to detect syntax or semantics errors. The results of these checks are indicated by red "wavy" underlining or by a change in the color of the text containing the detected error.
- A set of colors, which facilitates reading by distinguishing text (black) from operators (red), language key words (blue), and program comments (green)

■ The graphics editors for Ladder (LD), Function Block Diagram (FBD), and Sequential Function Chart (SFC) languages feature:

- A set of graphics elements for direct access to the various graphic symbols in the language via the mouse or keyboard
- A pop-up menu, which can be accessed simply by right-clicking the mouse

■ Unlimited number and length of comments. These comments can be positioned as text objects in any cell (graphical languages) or at any point in expressions (textual languages).

■ Assisted data entry functions via:

- Access to DFB function libraries, to the variable selector, and to the text object for entering comments
- Initialisation of a variable reference
- Initialisation of the animation table on selected variables
- Display and modification of the properties of the selected variable
- Creation of variables in real time without having to use the data editor

■ "Cut", "Copy", "Paste", "Delete", "Move", etc.

■ The use of bookmarks on lines of text or in the margin so that you can:

- Easily locate lines in important program sections
- Browse in an editor by bookmark, label, or line and column number



**Ladder (LD) language**

Each section or subroutine using Ladder language consists of a series of rungs executed sequentially by the PLC. Each rung consists of graphic objects (placed in cells arranged in columns and lines) corresponding to contacts, links, coils, operation blocks, EF/EFB/DFB function blocks, jumps, sub-routine calls, etc.

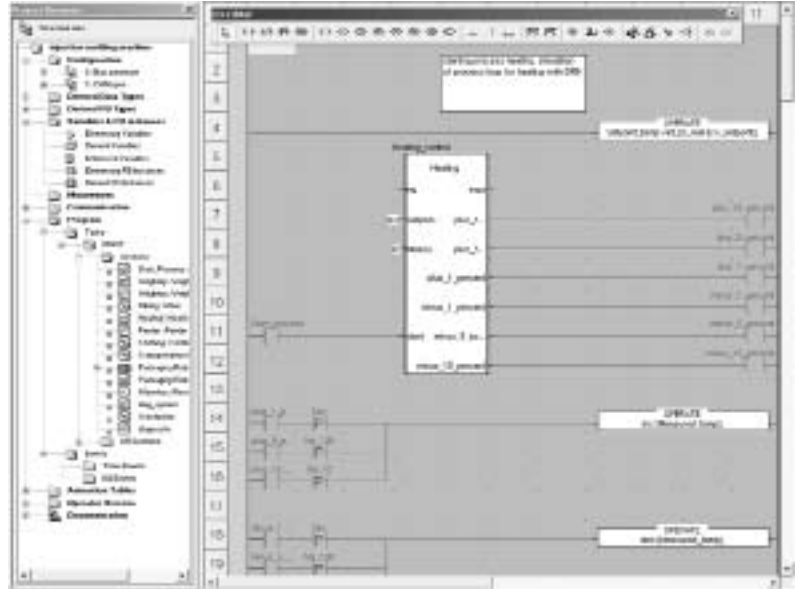

**Program structure** (section or subroutine)

Each Ladder language section can contain:

- Between 11 and 64 columns (number set by user)
- Up to 2,000 lines (for the rungs in the section)



Graphics palette in the Ladder language editor

"Mixed Display" mode supports the unrestricted display of comments, addresses, and symbols for the variables used for rungs.

**Function Block Diagram (FBD) language**

Function Block Diagram language is a graphical language based on function blocks associated with variables or parameters, which are linked together. This language is particularly well suited for process control applications.

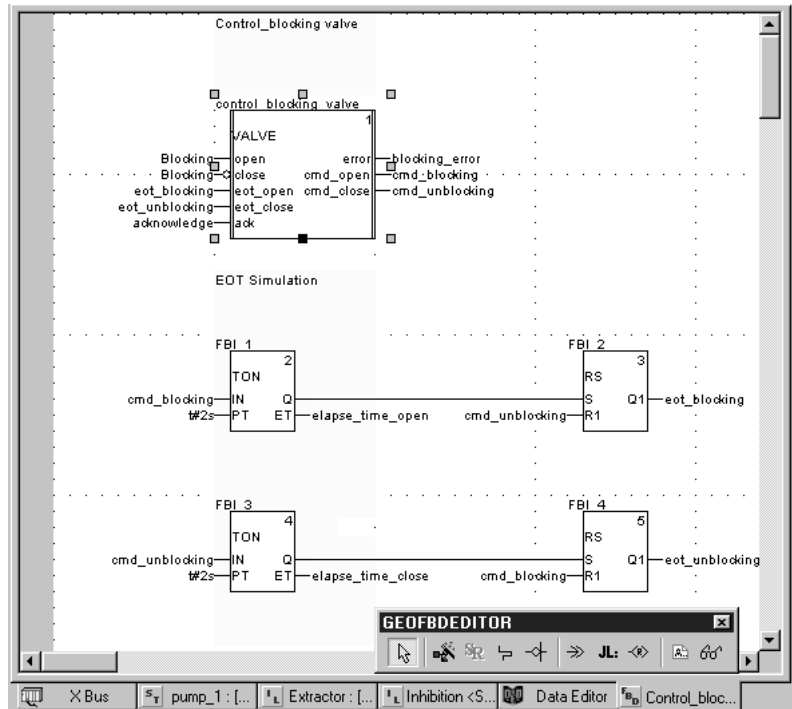

6

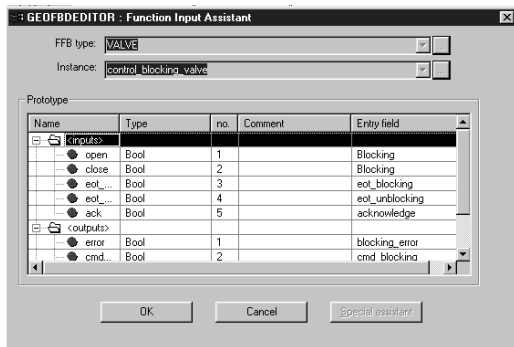

Function Block Assistant

**Program structure (section or subroutine)**

The FBD graphical language has three types of function block:

- Elementary blocks (EFs)
- Elementary Function Blocks (EFBs), sorted into different libraries depending on their type of use
- Derived Function Blocks (DFBs), which have a structure identical to that of EFBs but are created by the user with the ST, IL, LD, or FBD programming languages

Within the same section, subroutines can be called using a specific block. Program jumps to a block instance can also be programmed.

A section programmed in FBD language contains the equivalent of a grid with 30 columns and 23 rows. This can be extended to a wider page.

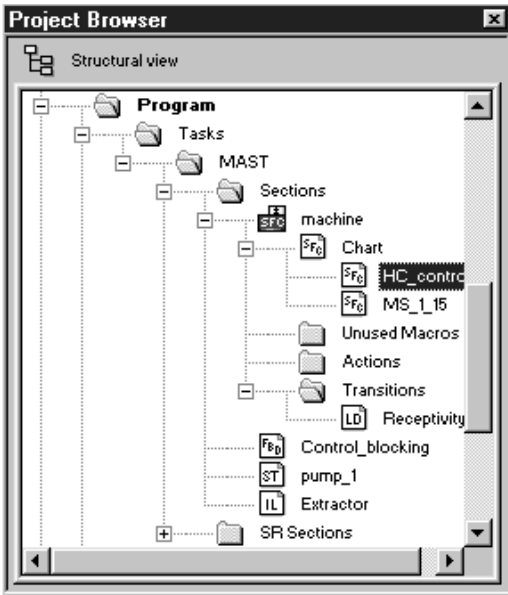

SFC structure in the browser

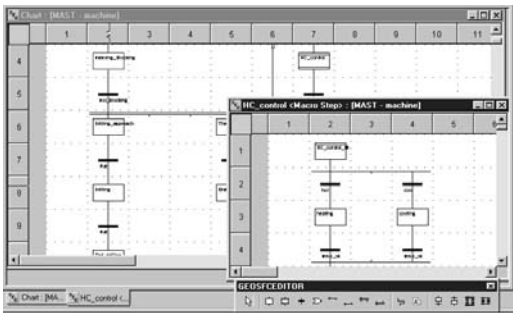

SFC charts

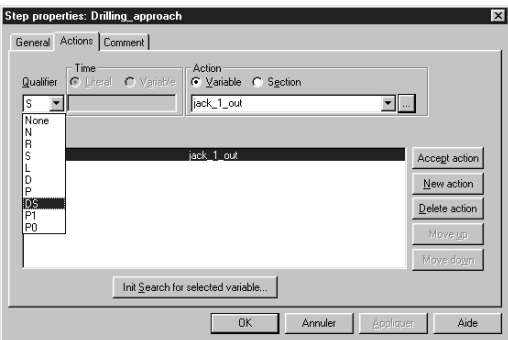

Step properties

**Sequential Function Chart (SFC)™ and Grafcet™ language**

Sequential Function Chart (and Grafcet) language can be used to describe the sequential part of an automation system in simple graphical format using steps and transitions.

SFC™ language does not process charts in the same way as Grafcet™ language:

- SFC only authorizes one token in a single chart.
- Grafcet language authorizes several tokens in a single chart.

Unity™ Pro software has one single editor for both of these languages with the option of defining behaviour in the application settings (*Tools/Project Settings/Language extensions menu*).

**Program structure (master task section)**

SFC language is only used in sections belonging to the master task. Each SFC section consists of a main chart sub-section (CHART) and sub-sections for each of the macro-steps. Charts consist of:

- Macro-steps, which are the unique representation of a set of steps and transitions (used to set up a hierarchical chart structure)
  - Steps
  - Transitions and directed links between steps and transitions
- Associated with steps and transitions, respectively, the actions and transition conditions can be:
- Integrated into the CHART or macro-step charts where the actions or transition conditions are defined by a single variable
  - Processed in specific sections, in which case dedicated processing (to be programmed in Ladder, Function Block Diagram, Structured Text or Instruction List language) is necessary
- In order to check that machine scans have been completed successfully, activity times (minimum, maximum) can be associated with each step. These times are set by the user.

**Program structure (section in master task)**

For each SFC section, the graphics editor provides a maximum of:

- One grid containing 32 columns and 200 rows, or 6,400 cells. Steps, transitions, or jumps all need one cell, respectively.
- 1,024 steps (macro-steps and steps in macro-steps)
- 20 actions assigned to the same step
- 100 steps activated at the same time
- 100 actions activated at the same time

To help you to create basic charts, graphic screens can be used to create "n" steps in series and "m" steps in parallel in a single operation.

Dialog boxes can be used to assign associated properties to steps (activity time, actions), transitions (variable linked to transition condition), etc.

#### Structured Text (ST) language

Structured Text language is a sophisticated, algorithmic type language particularly well suited for programming complex arithmetic functions, table operations, message handling, etc.

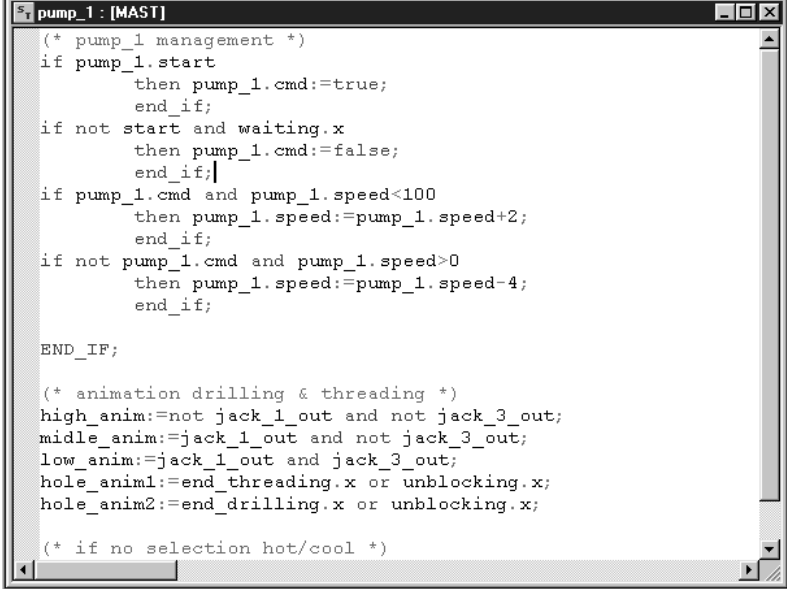

```

(* pump_1 management *)
if pump_1.start
  then pump_1.cmd:=true;
  end_if;
if not start and waiting.x
  then pump_1.cmd:=false;
  end_if;
if pump_1.cmd and pump_1.speed<100
  then pump_1.speed:=pump_1.speed+2;
  end_if;
if not pump_1.cmd and pump_1.speed>0
  then pump_1.speed:=pump_1.speed-4;
  end_if;

END_IF;

(* animation drilling & threading *)
high_anim:=not jack_1_out and not jack_3_out;
middle_anim:=jack_1_out and not jack_3_out;
low_anim:=jack_1_out and jack_3_out;
hole_anim1:=end_threading.x or unblocking.x;
hole_anim2:=end_drilling.x or unblocking.x;

(* if no selection hot/cool *)

```

#### Program structure (section or subroutine)

Structured Text language can be used to directly transcribe an analysis based on an organisation chart, is structured into expressions composed of a series of instructions organized in lines.

There is no limit to the number of characters an instruction line may contain (the only limit is the program memory available for the Modicon® Premium™, Quantum™ and M340™ platforms, except on TSX™ P57 10 to 40 processors, where the limit is 64 kbytes). The length of the section is only limited by the size of the application memory.

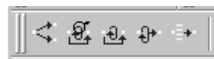

Four preformatted expression structures can be called up directly from the toolbar:

- **Conditional action:** *IF...THEN...ELSIF...THEN...ELSE...END-IF*
- **Iterative conditional action:** *WHILE...DO...END\_WHILE;*  
*REPEAT...UNTIL...END\_REPEAT*
- **Repetitive action:** *FOR...TO...BY...DO...END\_FOR*
- **Selective action:** *CASE...OF...ELSE...END\_CASE*

The operands used in the expressions are bit variables, word variables, or variables linked to function blocks.

To make the expressions easier to read, different colors are used to identify objects, language key words, and program comments.

## Instruction List (IL) language

Instruction List language represents the equivalent of a Ladder diagram in text form. It can be used to write Boolean and arithmetic equations using the functions available in the Unity™ Pro language (calling of functions and function blocks, assignment of variables, creation of program jumps, branching to subroutines within a program section, etc.).

```

(* Simple example *)
LD t#5s
ST delay

(* fault motor *)
LD overspeed
AND hot_temp
ST fault_motor

(* Start the motor after delay (in seconds) *)
CAL MOTOR_TIMER (PT := Delay, IN := start_motor)
LD motor_timer.q
ST motor_run

(* Stop the motor after ten seconds in running *)
cal stop_timer(motor_run,t#10s)
LDN stop_timer.q
ST start_motor
|

```

## Program structure (section or subroutine)

A program in Instruction List language is comprised of a sequence of instructions classified into the following different families:

- Bit instructions, for example, read input: *LD overspeed*
- Function block instructions, for example, call timer: *CALL MOTOR\_TIMER*
- Numerical instructions using single, double, and floating-point integers, for example, add: *LD Result ADD Surplus ST Archive*
- Word table or character string instructions, for example, make assignment: *LD Result:10:=Setpoint:10*
- Program instructions, for example, SR call: *CALL SR10*

The operands used in the expressions are bit variables, word variables, or variables linked to function blocks.

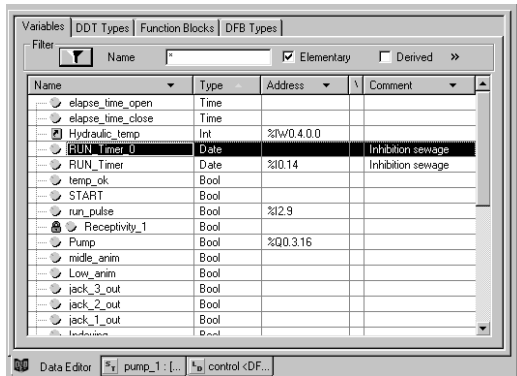

Data editor

**Data editor**

The data editor can be accessed from the structural view of the project, providing a single tool for performing the following editing tasks:

- Declaration of data including variables and function blocks (declaration of their type, instances, and attributes)
- Use and archiving of function block data types in different libraries
- Hierarchical view of data structures
- Searching, sorting, and filtering of data
- Creation of a hyperlink in the comments of any variable to access a description

The data are displayed on four tabs:

- "Variables" tab for the creation and management of the following data instances: bits, words, double words, inputs/outputs, tables, and structures
- "DDT Types" tab for the creation of derived data types (tables and structures)
- "Function Blocks" tabs for the declaration of EFB and DFB function blocks
- "DFB Types" for the creation of DFB user function block data types

Each data element has several attributes, including:

- The name and type of the variable are mandatory
- The comment, physical address in the memory, and initial values are optional

The data editor columns can be configured (number of columns, order). The attributes associated with a variable can be displayed in a properties window.

This editor can be accessed at any time during programming by selecting variables for data modification or creation.



Variable attributes

#### DFB user function blocks

With Unity™ Pro software, users can create their own function blocks for specific application requirements on Modicon® Premium™, Quantum™ and M340™ platforms. Once created and saved in the library, these user function blocks can be reused as easily as EFBs (Elementary Function Blocks).

The user function blocks can be used to structure an application. They are used when a program sequence is repeated several times in the application or for fixing a standard programming routine. They can be read-only protected or read/write-protected. They can be exported to other Unity Pro applications.

Using a DFB function block in one or more applications:

- Simplifies program design and entry
- Improves program readability and understanding
- Facilitates program debugging (variables handled by the DFB block function are identified in the data editor)
- Enables the use of private variables specific to the DFBs, which are independent of the application.

A DFB function block is set up in several phases:

- The DFB is designed by assigning a name, a set of parameters (inputs, outputs, public and private internal variables) and a comment to it via the data editor.
- The code is created in one or more sections of the program, with the following languages selected according to requirements: Structured Text, Instruction List, Ladder, or Function Block Diagram (ST, IL, LD, or FBD).
- The DFB may be stored in a library with an associated version number.
- A DFB instance is created in the data editor or when the function is called in the program editor.
- This instance is used in the program in the same way as an EFB (Elementary Function Block). (The instance can be created from within the program.)

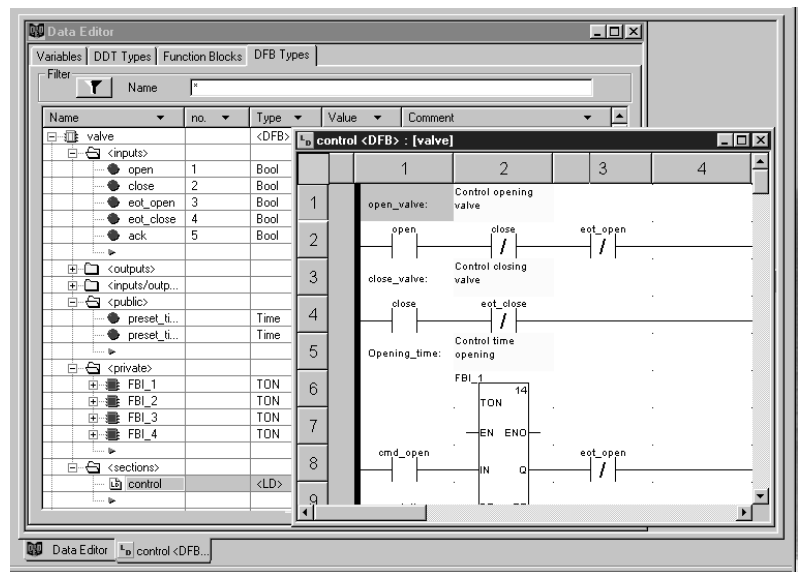

#### Main characteristics

<b>Inputs</b>	32, maximum (1)
<b>Outputs</b>	32, maximum (2)
<b>Inputs/outputs</b>	32, maximum (1) (2)
<b>Public internal variables</b>	Unlimited (3), can be accessed via the application program
<b>Private internal variables</b>	Unlimited (3), cannot be accessed via the application program
<b>Comments</b>	1,024 characters, maximum
<b>Program sections</b>	Unlimited, each section can be programmed independently in one of the 4 languages (IL, ST, LD, and FBD).

(1) The maximum cumulative total of inputs and inputs/outputs is 32.

(2) The maximum cumulative total of outputs and inputs/outputs is 32.

(3) For Premium processors, see page 1/10: characteristics, memory capacity, maximum size of object areas, unlocated internal data, and DFB and EFB function blocks.

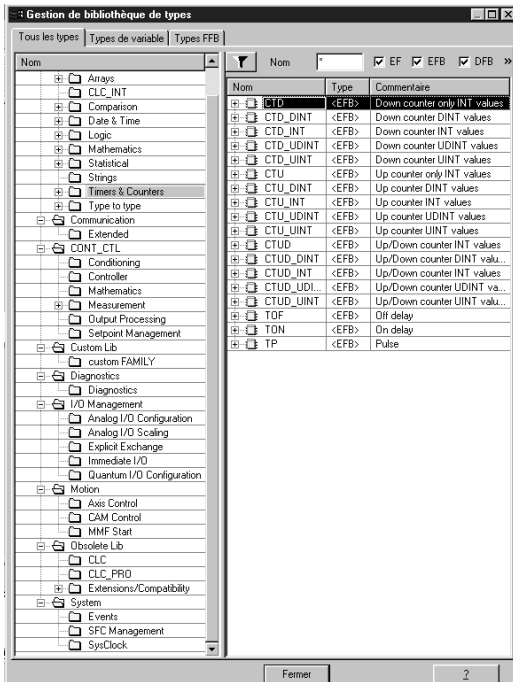

Standard function block libraries

### Function block libraries

The function and function block libraries manager contains the elements provided with Unity™ Pro software. The functions and function blocks are organized into libraries consisting of families. Depending on the type of PLC selected and the processor model, users will have a sub-set of these libraries available to write their applications. However, the “Base Lib” library contains a set of functions and function blocks that are compatible with the Modicon® Premium™, Quantum™ and M340™ PLCs. In particular, it contains the blocks compliant with IEC 61131-3.

The “Base Lib” library is structured into families:

- Timers and counters
- Process control on integers
- Array management
- Comparison
- Date and time management
- Logic processing
- Mathematical processing
- Statistical processing
- Character string processing
- Type-to-type data conversion

The “Base Lib” library, which covers standard automation functions, is supplemented by other, more application-specific libraries and platform-specific functions:

- **Communication library**, providing an easy means of integrating communication programs from PLCs with those used by HMIs from the PLC application program. Like other function blocks, these EFBs can be used in all languages to exchange data among PLCs or to deliver data to be displayed on an HMI.
- **Process control library**. The CONT\_CTL library can be used to set up process-specific control loops. It offers controller, derivative, and integral control functions, and additional algorithms such as: EFBs for calculating mean values, selecting a maximum value, detecting edges, or assigning a hysteresis to process values, etc.
- **Diagnostics library**, used to monitor actuators and contains EFBs for active diagnostics, reactive diagnostics, interlocking diagnostics, permanent process condition diagnostics, dynamic diagnostics, monitoring of signal groups, etc.
- **I/O management library**, providing services to handle information exchanged with hardware modules (formatting data, scaling, etc.)
- **Motion Function Blocks library**, containing a set of predefined functions and structures to manage motion controlled by drives and servo drives connected on CANopen
- **Motion library** for motion control and fast counting
- **“System” library**, providing EFBs for the execution of system functions, including: evaluation of scan time, availability of several different system clocks, SFC section monitoring, display of system state, management of files on the memory cartridge of the Modicon M340 processor, etc.
- Finally, a library named “obsolete” containing function blocks used by legacy programming software needed to perform application conversions

### Management of user standards

Users may create libraries and families in order to store their own DFB function blocks and DDT data structures. This enhancement allows users to take advantage of programming standards adapted to their needs, along with version management. This means that it is possible to:

- Check the version of the elements used in an application program against those stored in the library
- Perform an upgrade, if necessary

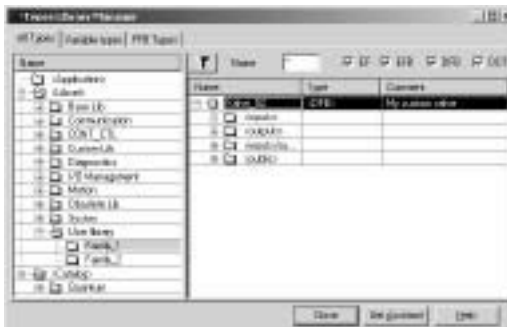

User-defined libraries





Insertion/deletion of watchpoint

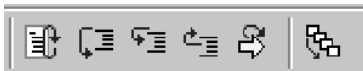

Execution: step-by-step command

```
Securete : [MAST]
IF Niveau_1 >= 600 THEN Pompe_1 := False;
END_IF;
IF Niveau_2 >= 200 Then Pompe_2 := False;
END_IF;
IF Niveau_3 >= 400 Then Vanne_1 := False;
Vanne_2 := False;
END_IF;
IF Boite = 10 Then Vanne_3 := False;
End_IF;
IF Niveau_3 < 80 Then Chauff_on := False;
:= False;
```

Animation of ST program

Name	Value	Type	Comment
Initial	0	Bool	
Niveau_1	420	Int	
Niveau_2	0	Int	
Niveau_3	333	Int	
Boite	0	Int	
Quantite_a_pr...	0	Int	
Quantite_prod...	0	Int	
Pompe_1	1	Bool	
Melange_2	0	Bool	

Animation table



### Debugging tools

Unity™ Pro software offers a complete set of tools for debugging Modicon® Premium™, M340™ and Quantum™ applications. A tool palette provides direct access to the main functions:

- Dynamic program animation
- Setting of watchpoints or breakpoints (not authorized in event-triggered tasks)
- Step-by-step program execution. A function in this mode enables section-by-section execution. Instruction-by-instruction execution can be launched from the previous breakpoint. Three execution commands are therefore possible when the element to be executed is a subroutine (SR) or DFB user block instance:
  - Detailed step-by-step, or "Step Into". This command is used to move to the first element of the SR or DFB.
  - Overall step-by-step, or "Step Over". This command is used to execute the entire SR or DFB.
  - Outgoing step-by-step, or "Step Out". This command is used to move to the next instruction after the SR or DFB element.
- Independent execution of the master (MAST), fast (FAST), auxiliary (AUX), and event-triggered (EVTi) tasks

### Animation of program elements

Dynamic animation is managed by program section. A button on the toolbar is used to activate or deactivate animation for each section.

When the PLC is in RUN, this mode can be used to view, simultaneously:

- The animation of a program section, regardless of the language used
- The variables window containing the application objects created automatically from the section viewed
- Several windows can be displayed and animated simultaneously. The "Tool tip" function, which uses help balloons, can be used to view a variable or its content simultaneously when the object is selected with the mouse (or other pointing device). Users can add inspection windows to display program variables.

Two types of animation are supported:

- Standard: The variables of the active section are refreshed at the end of the master task (MAST).
- Synchronized: The watchpoint can be used to synchronize the display of animated variables with a program element in order to determine their value at that precise point in the program.

### Animation table

Tables containing the variables of the application to be monitored or modified can be created by data entry or initialized automatically from the selected program section.

In addition to data animation it is possible to:

- Modify bit variables or force them to 0 or 1
- Change the display format
- Copy or move variables
- Search by cross-reference
- Display the list of forced bits

These tables can be stored in the application and retrieved from there at a later time.

### Debugging of DFB user function blocks

The parameters and public variables of these blocks are displayed and animated in real time using animation tables, with the option of modifying and forcing the required objects.

In exactly the same way as with other program elements, the watchpoint, breakpoint, step-by-step execution, and program code diagnostics functions can be used to analyze the behaviour of DFBs. Setting a breakpoint in a DFB user function block instance stops the execution of the task containing this block.



SFC control panel

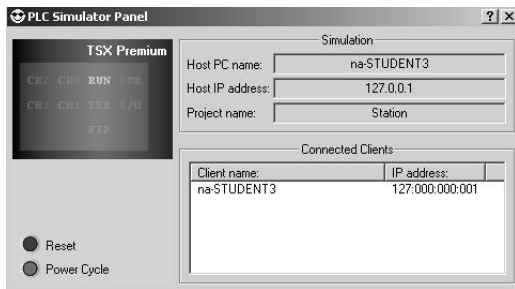

Simulator control panel

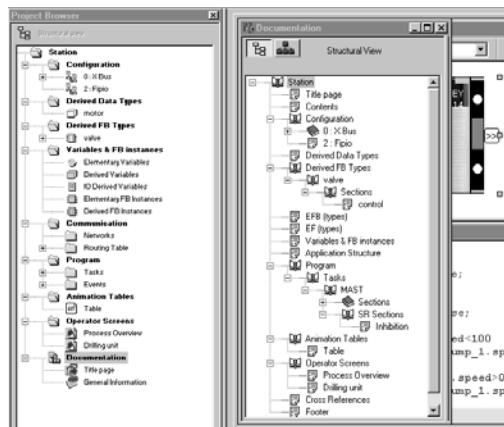

Access to documentation editor

### Debugging tools (continued)

#### Debugging in Sequential Function Chart (SFC)™ language

The various debugging tools are also available in SFC™ language. However, unlike other sections (IL, ST, LD, or FBD) an SFC section executed step-by-step does not stop execution of the task but instead freezes the SFC chart. Several breakpoints can be declared simultaneously within a single SFC section.

Numerous commands are available in this debugging mode via the control panel:

- Deactivate active step(s)
- Activate initial step(s)
- Disable step execution times
- Freeze chart regardless of transition conditions
- Stop processing of steps
- Move to the next step taking account of the transition conditions
- Enable transition and move to next step(s) (detailed step-by-step command: "Step Into")
- Enable transition in order to execute the end of the macro-step (outgoing step-by-step command: "Step Out")
- Pre-position chart on steps for which markers have been set, etc.

### PLC simulator

The simulator integrated into Unity™ Pro can be used to test the application program for Modicon® Premium™, Quantum™ and M340™ PLCs from the PC terminal without having to connect to the PLC processor. The functions provided by the debugging tools are available for debugging the master, fast, and auxiliary tasks.

Because the simulator does not manage the PLC I/O, animation tables can be used to simulate the state of inputs by forcing them to 0 or 1.

The simulator can be connected to third-party applications via an OPC server with OFS (OPC Factory Server™) software.

### Documentation editor

The documentation editor is based on the Documentation Browser, which shows the file structure in tree form.

It allows all or part of the application file to be printed on any graphics printer accessible under Windows and using True Type technology, in A4 or US letterprint format.

The documentation editor supports the creation of user-specific files using the following headings:

- Title page
- Contents
- General information
- Footer
- Configuration
- EF, EFB, and DFB type function blocks
- User variables
- Communication
- Project structure
- Program
- Animation tables and cross references
- Runtime screens

The documentation editor can generate the documentation file based on two different structures:

- Structural view: The objects in the project are associated with their corresponding headings.
- Functional view: The objects in the project are associated with the function modules to which they belong.

The documentation file can be created and saved as the project progresses, from one Unity™ Pro session to another.

## Presentation

Diagnostics integrated into Modicon® Premium™, Quantum™ and M340™ automation platforms

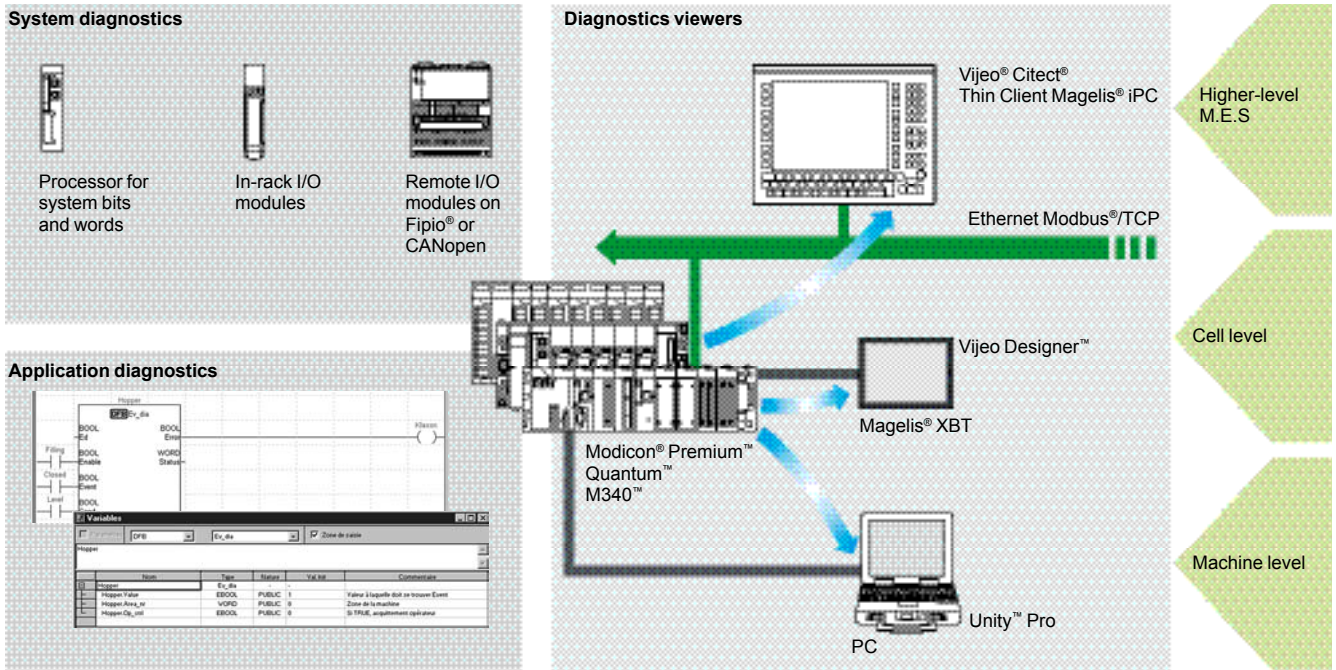

The diagnostics offer for Modicon® Premium™, Quantum™ and M340™ is based on three components:

- System diagnostics
- DFB and EFB diagnostic function blocks (for system and application diagnostics)
- Error message display system, called viewers, supplied as a standard component of Magelis® XBT terminals, Vijeo® Citect® supervisory software, and Unity™ Pro setup software

## Functions

### System diagnostics

The system diagnostics for the Modicon M340, Premium, and Quantum platforms support the monitoring of system bits/words, I/O modules, and activity times (minimum/maximum) of SFC steps. By simply choosing the relevant option during application configuration, any event will generate time-stamped messages logged in the diagnostic buffer of the PLC. These events are displayed automatically on a diagnostics viewer (1) without requiring any additional programming.

With Unity™ Pro integrated diagnostics, this function can be used to perform 1<sup>st</sup> level diagnostics of the elements in the configuration, up to and including each I/O module channel.

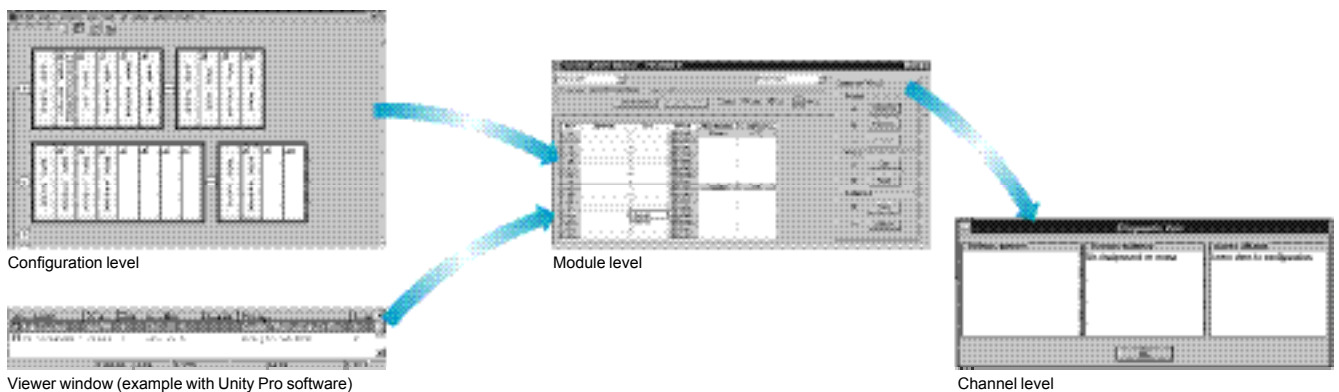

(1) Diagnostics viewers are tools used to display and acknowledge diagnostic error messages. They are supplied as a standard component of Unity Pro and Vijeo Designer software, with Magelis terminals, and with the PLC Web server that can be accessed via a Magelis iPC thin client.

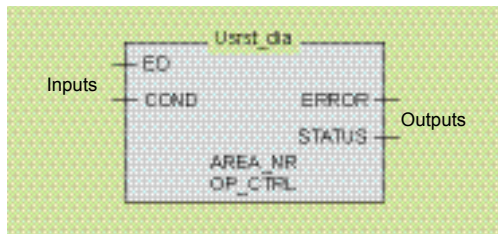

Diagnostics with detected fault cause analysis

### Functions (continued)

#### Application diagnostics

Unity™ Pro software features a library of function blocks for monitoring, called diagnostic DFBs and EFBs. The library of diagnostic function blocks is comprised of:

#### ■ Manufacturer blocks for system diagnostics

- IO\_DIA input/output detected fault, which is used to monitor the I/O states
- ASI\_DIA, which monitors whether a detected error has occurred on the AS-i bus (module or bus detected fault, no slave, slave not configured or inoperative)

#### ■ Manufacturer blocks for application diagnostics

- EV\_DIA, which monitors that an event (bit status) assumes the correct value at a specific time (no notion of timing)
- MV\_DIA, D\_GRP, D\_REA, which monitor whether an event (change of bit status) occurs according to predefined time conditions
- ALRM\_DIA, which monitors the combination of the status of 2 bits
- NEPO\_DIA and TEPO\_DIA, which are used to check, control, and perform diagnostics on elements of the operative part consisting of a combination of 2 preactuators and 2 sensors

#### ■ Open diagnostic blocks

These blocks allow users to create their own diagnostic function blocks customized to their specific applications, thus supplementing the manufacturer DFBs and EFBs presented above. Open diagnostic blocks are created from 2 model blocks, which must be written in Ladder (LD) language, or in Structured Text (ST), Function Block Diagram (FBD), or Instruction List (IL).

#### Diagnostics with detected fault cause analysis

In addition, when a detected fault occurs, Unity Pro analyzes the relevant program sections and displays the probable causes and sources of the detected fault in a second window.

Thus, the user or process operator is guided through the detected fault analysis process and will be able to reduce machine downtime as a result.

Furthermore, with the diagnostics viewer integrated into Unity Pro, the instruction or module that caused the detected fault can be accessed directly from the alarm displayed in the viewer display window (see page 6/25 of this catalog).



Viewer



#### Functions (continued)

##### Diagnostics viewers

The diagnostic events processed by the Modicon® Premium™, Quantum™ and M340™ platforms via diagnostic DFBs/EFBs are stored in a buffer (specific data memory area of the PLC). The information contained in this buffer is sent (transparently for the user) to viewers for automatic display and for management of detected faults and alarms. The view function is supplied as a standard component for:

- Vijeo Designer™ configuration software
- Unity™ Pro programming software
- Magelis® XBT GT and Magelis® iPC graphic display terminals

The viewer integrated into Unity Pro can also be used to access the instruction or module that is the source of the detected fault. See "Diagnostics with detected fault case analysis" on page 6/26.

The Modicon M340, Premium, and Quantum platforms have multiviewer capability (and can be connected to up to 15 viewers). A PC-compatible station with the viewer function can have multi-PLC capability (and can be connected to up to 15 Modicon M340/Premium/Quantum platforms).

The buffer/viewer structure supports:

- A single point for detected fault management in each application
- Time-stamping of the occurrence of detected faults at the source
- Storage of intermittent detected faults in memory
- Independence with regard to the viewer functionality. The frame sent from the PLC buffer is identical for each viewer.
- Automatic archiving of error messages

##### Display window

The diagnostics viewer takes the form of a display window divided into 2 sections:

- A message list area containing, for each alarm: state, DFB type, geographical zone, dates and times of appearance/disappearance, associated message, and status
- An area for additional information about the selected message: type, comments, date of appearance, specific data, variables in error state, etc.

##### Runtime screens

The runtime screens tool is integrated into Unity™ Pro software. Runtime screens are designed to facilitate the running of automated processes during debugging, startup, and maintenance. Runtime screens provide a range of information (explanatory texts, display of dynamic values, control buttons, and views), enabling users to act quickly and easily to modify and dynamically monitor PLC variables.

The runtime screens editor provides the HMI (*Human/Machine Interface*) elements needed for the animated design and viewing of processes. It enables these screens to be designed using specific tools:

- Screen: creation of runtime screens, which can be classified according to family
- Message: creation of messages to be displayed
- Objects: creation of a graphic objects libraries based on:
  - Geometrical elements (line, rectangle, ellipse, incorporation of images, controller front panels, etc.)
  - Control elements (buttons, data entry fields, screen browsing controls, etc.)
  - Animation elements (colors, flashing elements, bar graphs, etc.)

When the station on which Unity Pro has been installed is connected to the PLC, users can obtain a dynamic screen display based on the process state. Depending on the assigned priority, screens can be sequenced via a keyboard command or a PLC request.

In online mode, the Unity Pro application program can be accessed directly via the runtime screens simply by clicking the selected object in a screen view. It is also possible to activate the animation-table or cross-reference functions after selecting one or more variables on the screen. To make the display easier to read, the views can be displayed in full screen mode. Because it is possible to create or modify a runtime screen when the PLC is in Run mode, this service increases productivity during installation and maintenance phases.

### Modifying the program with the PLC in RUN mode

With Unity™ Pro, changes can be made to the program when the PLC connected to the programming terminal is in RUN mode. These modifications are performed with the following operations:

- The application contained in the PLC is transferred to the PC terminal running Unity Pro, if necessary.
- Program changes are prepared. These program modifications can be of any type and in any language (IL, ST, LD, FBD, and SFC), for example, addition or deletion of SFC steps or actions. The code of a DFB user function block can also be modified (however, modifications of its interface are not permitted).
- These program changes are updated in the PLC (in RUN mode).

This function makes it possible to add or modify program code and data in different parts of the application in one single modification session (thus resulting in a unified, consistent modification with respect to the controlled process). This increased flexibility comes at a cost in terms of the amount of program memory required.

### Cross-reference function

The Unity™ Pro cross reference function, which is available in standalone mode (offline) and when connected to the PLC in Run (online), allows users to view the elements of a PLC application when searching for any type of variable. This view indicates where the declared variable is used, as well as how it is used (for writing, reading, etc.).

This function also provides access to the Search/Replace function for variable names.

The variable search can be initialized from any editor (language, data, runtime screen, animation table, etc.).

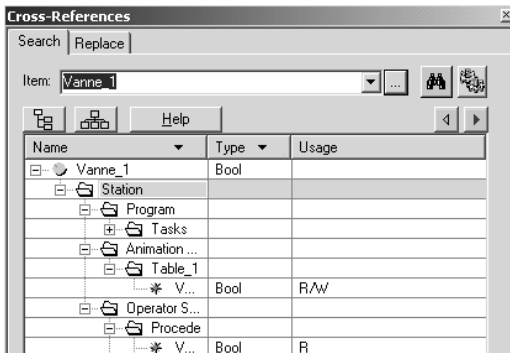

### Import/export function

The import/export function available in Unity Pro supports the following operations from the structural and functional project views:

- Via the import function, reuse in the current project up to 100% of a project created previously
- Via the export function, copying up to 100% of the current project to a file for subsequent reuse

The files generated during export are generally in XML format (1). However, in addition to XML, variables can be exported and imported in the following formats:

- .xvm format compatible with OFS data server software
- Source format, in an .scy file compatible with the PL7 programming software
- Text format with separator (TAB) in a .txt file for compatibility with any other system

During an import, a wizard can be used to reassign data to new instances of:

- DFB function blocks
- DDT data structures
- Simple data

In addition, when a functional module is imported, the data associated with animation tables and runtime screens are also reassigned.

The XML import function also supports the transfer of a Modicon® Premium™, Quantum™ or M340™ PLC configuration prepared in the SIS Pro costing and configuration tool for use in the creation of a project in Unity Pro.

This import function spares the user from having to redefine the PLC configuration when the PLC has already been configured with the SIS Pro tool.

(1) XML language: An open, text-based language that provides structural and semantic information.



### Application converters

Unity™ Pro integrated conversion tools can be used to convert PLC applications created with Concept™ and PL7™ programming software to Unity Pro applications.

#### Concept/Unity Pro converter (Modicon® Quantum™ PLC)

This conversion is performed with a Concept application V2.5 or later (it can also be performed in V2.11 or later, but only after an update to V2.5). In order to perform the conversion, the application must be exported to an ASCII file in Concept.

The export file is converted to a Unity Pro source file automatically. This source file is then analysed by Unity Pro. At the end of the procedure, a conversion report is generated, and an output window displays any conversion errors and provides direct access to the part of the program to be modified.

The Concept application converter converts the application to Unity Pro, but does not guarantee that it will operate correctly in real time. It is therefore essential to test or debug converted applications.

#### PL7/Unity Pro converter (Modicon® Premium™ PLC)

This conversion is performed with a PL7 application V4 or later (Premium PLC). In order to perform the conversion, the source file (complete application) or source file (user function block) must be exported in PL7.

The conversion procedure is similar to that of the Concept conversion described above.

**Note:** Applications created with Concept, Modsoft, and ProWorx can be converted to LL984. Please consult your Regional Sales Office.

### Operating system update utilities

The OS-Loader software designed for updating operating systems on Premium and Quantum platforms is supplied with Unity Pro software.

It is used to upgrade processors and modules in PL7 or Concept for compatibility with Unity Pro:

- Premium **TSX™ P57 2●3M/2623M** and **TSX P57 3●3M/3623M** processors
- Quantum **140 CPU 434 12A** and **140 CPU 534 14A** processors (requires version PV 04 or later)
- Ethernet **TSX™ ETY ●102** and **140 NOE 771 ●1** communication modules
- EtherNet/IP **TSX™ ETC 100** and **140 NOC 77100** communication modules

These operating system updates are performed as follows for the various processor types:

- Uni-Telway™ RS 485 terminal link for Premium processors
- Modbus® or Modbus Plus™ terminal link for Quantum processors
- Ethernet Modbus/TCP network for integrated Ethernet port on Premium processors and Ethernet Premium and Quantum modules(1)

**Note:** For Modicon M340, this service is provided by Unity Loader.

(1) The operating system of the Quantum **140 CPU 671 60** processor is updated over an Ethernet network using its MT-RJ type fiber-optic connector (via a ConneXium transceiver or switch for a copper wire/fiber-optic interface).

## Unity™ Pro XLS

In addition to the functions of Unity™ Pro Extra Large, Unity™ Pro XLS provides a set of function blocks of specific checks and protections to facilitate the creation and debugging of Modicon® Quantum™ safety projects. For a description of these characteristics and their setup, as well as the functional limitations provided for within the framework of SIL 2-certifiable safety projects according to IEC 61508, refer to the document entitled "Quantum Safety PLC, Safety Reference Manual" 11/2007, n° 3303879.00, approved by TÜV Rheinland and available at [www.schneider-electric.com](http://www.schneider-electric.com).

The Unity Pro XLS programming tool is certified compliant with the requirements of IEC 61508 for the management of safety applications with Quantum **140 CPU 651 60S/671 60S** PLCs.

It offers the complete range of functions required to program a safety project:

- In-depth detected error diagnostics
- Project protection

During project creation, it is the selection of the Quantum processor that determines whether or not the project created will be a safety project.

Unity Pro XLS is capable of processing any Unity Pro application type. No other programming tool is needed on the computer.

To program a safety project, Unity™ Pro XLS provides two IEC 61131-3 programming languages:

- Function Block Diagram (FBD)
- Ladder language (LD)

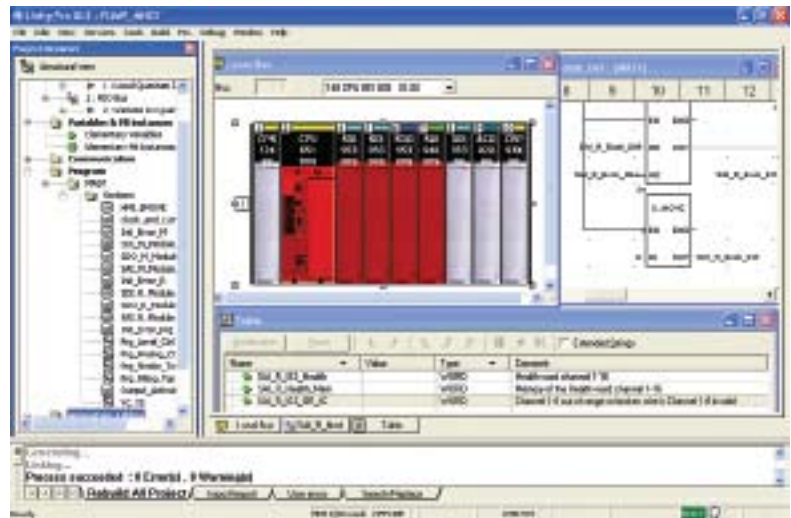



### Unity™ Pro XLS (continued)

#### Safety program structure

A safety project must be programmed entirely in a master task (MAST).

It is not possible to:

- Program FAST, TIMER, INTERRUPT, or AUX tasks
- Use subroutines (SR sections)

#### Language elements

Unity™ Pro XLS provides a set of specific, certified functions and function blocks. These are available in the "Unity Pro safety function block library".

Most of the language elements are available:

- Elementary data types (EDTs): BOOL, EBOOL, BYTE, WORD, DWORD, INT, UINT, DINT, UDINT, and TIME
- Simple arrays used exclusively for Ethernet Global Data communication
- Direct addressing, for example, writing %MW to memory via a coil in Ladder Logic (LD)
- Located variables

#### Project checking options

Unity Pro XLS provides the following different options for the checks performed by the language analyser:

- Unused variables
- Variables written multiple times
- Unassigned parameters
- FB instances used multiple times
- Address overlapping

It is advisable to enable all options when checking a safety project.

## Unity™ Pro XLS (continued)

### Protecting the project

Unity™ Pro XLS provides protective functions against unauthorized access to safety projects, to the Quantum™ safety PLC, and to Unity Pro XLS itself.

- The application password, defined when the safety project was created, is requested:
  - When the safety application file is opened
  - Upon connection to the safety PLC



- The safety editor integrated into Unity Pro XLS is used to define the access permissions and the list of authorized functions for each user, in particular:
  - Creation and modification of the application password
  - Activation of maintenance mode
  - Adjustment of the auto-lock period

### Functions and function blocks for safety applications

Unity Pro XLS provides a set of elementary functions (EFs) and elementary function blocks (EFBs) certified for use in safety applications:

- Standard functions certified for safety applications:
  - Mathematical functions and functions for manipulating data from the unrestricted memory area in the safety logic
  - Comparison functions
  - Logical functions, rotations, offsets
  - Statistical functions
  - Timer and counter setup
  - Type conversions
- Specific functions for safety architectures:
  - Setup of high availability: choice between two discrete I/O module inputs or redundant analog inputs
  - Setup of hot standby PLC redundancy: to cause the two processors involved in a hot standby configuration to change roles from primary to standby and standby to primary, respectively. The objective is to verify the capacity of each processor to take over in case the other processor becomes inoperative. With Unity Pro XLS, this function can easily be programmed in the application by setting up the S\_HSBY\_SWAP elementary function from the library.

## Distinctive features and specific procedures

### Auto-testing software tools

Unity™ Pro XLS provides the option of performing an auto-test to verify that the software components installed have not been corrupted, for example, due to a hard disk failure. This auto-test is based on a CRC calculation.

Unity™ Pro XLS checks the version and CRC:

- Of its DLLs
- Of the library database of the safety FFB
- Of the catalog database of hardware products

Unity Pro XLS auto-tests are performed upon request by the user, for example:

- After installing or uninstalling any program on the computer
- Before loading the final application program onto the safety PLC
- Before modifying the application program executed on the safety PLC

### Time-stamping binary files

With Unity Pro XLS, every binary file generated for a safety project features a version management field that provides the date and time when it was generated. This information is useful for checking the project.

### Downloading a project to Unity Pro XLS

It is possible to download a safety project from the PLC to Unity Pro XLS under the following conditions:

- This must have been defined as an option for the safety project.
- The user must know the application password to establish a connection to the safety PLC.
- The safety PLC must be placed in maintenance mode to perform the download.

### Unrestricted memory

The unrestricted memory area contains bits and words that are not protected against write operations from external equipment such as HMI terminals, PLCs, etc.

- It is located at the beginning of the memory.
- Its size can be configured with Unity Pro XLS.
- Values cannot be used directly in the unrestricted memory area and can only be used in conjunction with specific function blocks: S\_MOVE\_BIT and S\_MOVE\_WORD.

In the edit phase first and then in the generation phase, Unity Pro XLS checks to make sure that only data from the unrestricted memory area are used at the input of the function blocks S\_MOVE\_BIT and S\_MOVE\_WORD.

Furthermore, Unity Pro XLS provides a useful list of cross references, allowing easy identification of the way variables are used and verification of the application of this rule.

*Note: For safety applications, it is common practice to verify the correct transfer of data by writing the data twice (to two different variables) and then comparing them.*

#### Communication drivers

The drivers used most frequently with the Modicon® Premium™ and Quantum™ platforms are installed at the same time as the Unity™ Pro software.

Unity Pro also includes the following communication drivers, which can be installed as required (1):

Driver type	Windows XP® Windows 2000	Windows NT®	Windows 98 Millenium®	Windows 95®
Uni-Telway™ COM port	V1.9 IE20	V1.9 IE17	V1.7 IE18	V7.8 IE18
Uni-Telway™ TSX SCP 114	V1.2 IE05			
Modbus® COM port	V1.6 IE29			
Fip® ISA TSX FPC10 card	V1.4 IE06	V1.3 IE08	V1.4 IE06	V2.4 IE08
Fip® PCMCIA TSX FPC20 card	V1.2 IE03	V1.1 IE08	V1.2 IE04	
Ethway™	V1.4 IE05	V1.1 IE03	V2.6 IE06 (2)	
ISAway™ PCX 57, ISA card	V1.2 IE04	V1.5 IE06	V1.2 IE04	V1.2 IE09
PClway™, PCI card	V1.1 IE09	-		
XIP X-Way on TCP	V1.10 IE22			
USB for USB terminal port	V1.2 IE17	-		

#### Unity™ Developer's Edition, advanced open access

Advanced open access, intended for experienced IT engineers, supports the development of interfaces between Unity and expert tools, as well as specific user-defined functions.

This type of development requires experience in the following IT areas:

- C++® or Visual Basic® languages
- Client/server architectures
- XML and COM/DCOM technologies
- Database synchronization

As a supplement to the Unity Pro Extra Large software (3), the UDE (Unity Developer's Edition) development kit **UNY UDE VFU CD21E** enables the development of customized solutions. In addition to the development kit, the Unity servers and accompanying documentation are also provided.

Unity™ Developer's Edition is compatible with:

- Unity™ Pro Extra Large
- Modicon® M340™ processors
- Premium™ Unity™ processors
- Quantum™ Unity™ processors

(1) Also available separately under reference **TLX CD DRV 20M**.

(2) Windows 98 only

(3) Only the Unity Pro Extra Large version enables dynamic database management for data to be exchanged with the OFS data server or a third-party tool.

# Modicon® Premium™ automation platform

## Unity™ Pro software

### S / M / L / XL / XLS

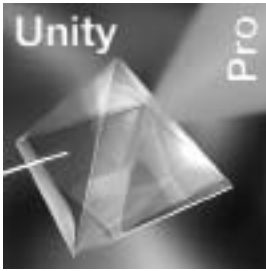

#### References

##### Unity™ Pro Small, Medium, Large, Extra Large, and XLS software packages

The software is available in 5 versions:

- **Unity Pro Small** for programming and setting up Unity™ automation platforms:
  - Modicon® M340™ BMX P34 1000 and BMX P34 20●0
- **Unity Pro Medium** for programming and setting up Unity automation platforms:
  - Modicon M340 BMX P34 1000 and BMX P34 20●0
  - Premium™ TSX™ 57 0●, 57 10, and 57 20
- **Unity Pro Large** for programming and setting up Unity automation platforms:
  - Modicon M340 BMX P34 1000 and BMX P34 20●0
  - Premium TSX 57 0●, 57 10, 57 20, 57 30, and 57 40
  - Quantum™ with processors 140 CPU 311 10, 434 12U, and 534 14U
- **Unity Pro Extra Large** for programming and setting up all Unity automation platforms:
  - Modicon M340 BMX P34 1000 and BMX P34 20●0
  - Premium TSX 57 0●, 57 10, 57 20, 57 30, 57 40, 57 50, and 57 60
  - Quantum with processors 140 CPU 311 10, 434 12U, 534 14U, 651 50, 651 60, 652 60, and Hot Standby 140 CPU 671 60
- **Unity Pro XLS** for programming and setting up all Unity and Unity Safety automation platforms:
  - Modicon M340 BMX P34 1000 and BMX P34 20●0
  - Premium TSX 57 0●, 57 10, 57 20, 57 30, 57 40, 57 50, and 57 60
  - Quantum with processors 140 CPU 311 10, 434 12U, 534 14U, 651 50, 651 60, 652 60, and Hot Standby 140 CPU 671 60
  - Quantum with safety processors 140 CPU 651 60S and Hot Standby 140 CPU 671 60S

##### Upgrade kits for Concept™, PL7™ Pro, and ProWORX™ software

These upgrade kits allow users who already have these software programs from the installed base and who have a **current subscription** to obtain Unity Pro version V4.0 software at a reduced price. These upgrades are only available for licenses of the same type (from Concept™ XL license group to Unity™ Pro Extra Large license group).

##### Composition and Windows OS compatibility

Unity Pro multilingual software packages are compatible with Windows 2000 Professional and Windows XP operating systems.

They are comprised of the following elements:

- Documentation in electronic format in 6 languages (English, German, Chinese, Spanish, French, and Italian)
- Converters for converting applications created with Concept and PL7 Pro programming software
- PLC simulator

Cables for connecting the processor to the programming PC must be ordered separately.

# Modicon® Premium™ automation platform

## Unity™ Pro software

Small / Medium



### Unity™ Pro Small version 4.0 software

For PLCs: **BMX P34 1000** **BMX P34 20•0**

#### Unity Pro Small version 4.0 software packages

Description	Licence type	Reference	Weight kg
Unity Pro Medium software packages	Single (1 station)	<b>UNY SPU SFU CD 40</b>	–
	Group (3 stations)	<b>UNY SPU SFG CD 40</b>	–
	Team (10 stations)	<b>UNY SPU SFT CD 40</b>	–
Software upgrades from: - Concept™ S - PL7™ Micro - ProWORX™ NxT/32 Lite	Single (1 station)	<b>UNY SPU SZU CD 40</b>	–
	Group (3 stations)	<b>UNY SPU SZG CD 40</b>	–
	Team (10 stations)	<b>UNY SPU SZT CD 40</b>	–

#### Licence type extension for Unity Pro Small software

From	To	Reference	Weight kg
Single (1 station)	Group (3 stations)	<b>UNY SPU SZUG CD 40</b>	–
Group (3 stations)	Team (10 stations)	<b>UNY SPU SZGT CD 40</b>	–

### Unity™ Pro Medium version 4.0 software

For PLCs: **BMX P34 1000** **TSX 57 0•...57 20**  
**BMX P34 20•0** **TSX PCI 57 20**

#### Unity Pro Medium version 4.0 software packages

Description	Licence type	Reference	Weight kg
Unity Pro Medium software packages	Single (1 station)	<b>UNY SPU MFU CD 40</b>	–
	Group (3 stations)	<b>UNY SPU MFG CD 40</b>	–
	Team (10 stations)	<b>UNY SPU MFT CD 40</b>	–
Software upgrades from: - Concept S, M - PL7 Micro, Junior - ProWORX NxT/32 Lite	Single (1 station)	<b>UNY SPU MZU CD 40</b>	–
	Group (3 stations)	<b>UNY SPU MZG CD 40</b>	–
	Team (10 stations)	<b>UNY SPU MZT CD 40</b>	–

#### License type extension for Unity Pro Medium software

From	To	Reference	Weight kg
Single (1 station)	Group (3 stations)	<b>UNY SPU MZUG CD 40</b>	–
Group (3 stations)	Team (10 stations)	<b>UNY SPU MZGT CD 40</b>	–

#### Software upgrade from Unity Pro Small to Unity Pro Medium software

Description	Licence type	Reference	Weight kg
Single (1 station)		<b>UNY SPU MZSU CD 40</b>	–
Group (3 stations)		<b>UNY SPU MZSG CD 40</b>	–
Team (10 stations)		<b>UNY SPU MZST CD 40</b>	–

# Modicon® Premium™ automation platform

## Unity™ Pro software

### Large / Extra Large



#### Unity™ Pro Large version 4.0 software

For PLCs:	<b>BMX P34 1000</b>	140 CPU 311 10
	<b>BMX P34 20●0</b>	140 CPU 434 12U
	<b>TSX™ 57 0●...57 40</b>	140 CPU 534 14U
	<b>TSX™ PCI 57 20/30</b>	

#### Unity Pro Large version 4.0 software packages

Description	Licence type	Reference	Weight kg
Unity Pro Large software packages	Single (1 station)	<b>UNY SPU LFU CD 40</b>	–
	Group (3 stations)	<b>UNY SPU LFG CD 40</b>	–
	Team (10 stations)	<b>UNY SPU LFT CD 40</b>	–
	Site (≤ 100 users)	<b>UNY SPU LFF CD 40</b>	–
Software upgrades from: - Concept™ S, M - PL7™ Micro, Junior, Pro - ProWORX™ NxT/32 Lite	Single (1 station)	<b>UNY SPU LZU CD 40</b>	–
	Group (3 stations)	<b>UNY SPU LZG CD 40</b>	–
	Team (10 stations)	<b>UNY SPU LZT CD 40</b>	–
	Site (≤ 100 users)	<b>UNY SPU LZF CD 40</b>	–

#### Licence type extension for Unity Pro Large software

From	To	Reference	Weight kg
Single (1 station)	Group (3 stations)	<b>UNY SPU LZUG CD 40</b>	–
Group (3 stations)	Team (10 stations)	<b>UNY SPU LZGT CD 40</b>	–

#### Software upgrade from Unity Pro Medium to Unity Pro Large software

	Licence type	Reference	Weight kg
Single (1 station)		<b>UNY SPU LZSU CD 40</b>	–
Group (3 stations)		<b>UNY SPU LZSG CD 40</b>	–
Team (10 stations)		<b>UNY SPU LZST CD 40</b>	–

#### Unity™ Pro Extra Large version 4.0 software

For PLCs:	<b>BMX P34 1000</b>	140 CPU 434 12U
	<b>BMX P34 20●0</b>	140 CPU 534 14U
	<b>TSX 57 0●...57 60</b>	140 CPU 651 50/60
	<b>TSX PCI 57 20/30</b>	140 CPU 652 60
	<b>140 CPU 311 10</b>	140 CPU 671 60

#### Unity Pro Extra Large version 4.0 software packages

Description	Licence type	Reference	Weight kg
Unity Pro Extra Large software packages	Single (1 station)	<b>UNY SPU EFU CD 40</b>	–
	Group (3 stations)	<b>UNY SPU EFG CD 40</b>	–
	Team (10 stations)	<b>UNY SPU EFT CD 40</b>	–
	Site (≤ 100 users)	<b>UNY SPU EFF CD 40</b>	–
Software upgrades from: - Concept S, M, XL - PL7 Micro, Junior, Pro - ProWORX NxT Lite, Full - ProWORX 32 Lite, Full	Single (1 station)	<b>UNY SPU EZU CD 40</b>	–
	Group (3 stations)	<b>UNY SPU EZG CD 40</b>	–
	Team (10 stations)	<b>UNY SPU EZT CD 40</b>	–
	Site (≤ 100 users)	<b>UNY SPU EZF CD 40</b>	–

#### License type extension for Unity Pro Extra Large software

From	To	Reference	Weight kg
Single (1 station)	Group (3 stations)	<b>UNY SPU EZUG CD 40</b>	–
Group (3 stations)	Team (10 stations)	<b>UNY SPU EZGT CD 40</b>	–

#### Software upgrade from Unity Pro Large to Unity Pro Extra Large software

	Licence type	Reference	Weight kg
Single (1 station)		<b>UNY SPU EZSU CD 40</b>	–
Group (3 stations)		<b>UNY SPU EZSG CD 40</b>	–
Team (10 stations)		<b>UNY SPU EZST CD 40</b>	–

# Modicon® Premium™ automation platform

## Unity™ Pro software

### Unity™ Pro XLS



#### Unity™ Pro XLS version 3.1 software

For PLCs:	BMX P34 1000	140 CPU 534 14U
	BMX P34 20●0	140 CPU 651 50/60
	TSX™ 57 0●...57 60	140 CPU 652 60
	TSX™ PCI 57 20/30	140 CPU 671 60
	140 CPU 311 10	140 CPU 651 60S
	140 CPU 434 12U	140 CPU 671 60S

#### Unity Pro XLS version 3.1 software packages

Description	Licence type	Reference	Weight kg
Unity Pro XLS software packages	Single (1 station)	UNY SPU XFU CD 31	–
	Group (3 stations)	UNY SPU XFG CD 31	–
	Team (10 stations)	UNY SPU XFT CD 31	–
	Site (≤ 100 users)	UNY SPU XFF CD 31	–
Software upgrades from: - Concept™ S, M, XL - PL7™ Micro, Junior, Pro - ProWORX™ NxT Lite, Full - ProWORX™ 32 Lite, Full	Single (1 station)	UNY SPU XZU CD 31	–
	Group (3 stations)	UNY SPU XZG CD 31	–
	Team (10 stations)	UNY SPU XZT CD 31	–
	Site (≤ 100 users)	UNY SPU XZF CD 31	–

#### Software for Unity™ Pro version 3.1

##### Unity™ Developer's Edition

For PLCs:	BMX P34 1000	140 CPU 534 14U
	BMX P34 20●0	140 CPU 652 60
	TSX 57 0●...57 60	140 CPU 671 60
	TSX PCI 57 20/30	140 CPU 651 60S
	140 CPU 311 10	140 CPU 671 60S
	140 CPU 434 12U	

Description	Licence type	Reference	Weight kg
UDE Unity Developer's Edition Requires Unity Pro Extra Large or Unity Pro XLS	Single (1 station)	UNY UDE VFU CD21E	–





## References (continued)

## Documentation for Unity™ Pro version 3.1

For PLCs	Description	Licence type	Reference	Weight kg
Hardware and software manuals (on DVD)	Platform setup for: - Modicon® Premium™ - M340™ - Quantum™ - Momentum™  Electromagnetic compatibility of networks and fieldbuses  Software setup for: - Unity Pro - Function block library	Multilingual: English, German, Chinese, Spanish, French	UNY USE 909 CD M	–

## Separate parts

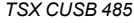
Description	From Processor	To PC port	Length	Reference	Weight kg
PC terminal connection cables	USB mini B port BMX P34 1000/20●0	USB port	1.8 m	BMX XCA USB H018	0.065
			4.5 m	BMX XCA USB H045	0.110
 TSX PCX 1031	Mini-DIN port Premium TSx 57 1●/2●/3●/4●	RS 232D (9-pin D-SUB connector)	2.5 m	TSX PCX 1031	0.170
			0.4 m	TSX CUSB 485 (1)	0.144
			2.5 m	TSX CRJMD 25 (1)	0.150
			3.7 m	990 NAA 263 20	0.300
 990 NAA 263 50	Modbus® port 15-pin D-SUB Quantum 140 CPU 311 10 140 CPU 434 12A 140 CPU 534 14A	RS 232D (15-pin D-SUB connector)	15 m	990 NAA 263 50	0.180
			3.3 m	UNY XCA USB 033	–
			1 m	110 XCA 282 01	–
 110 XCA 282 02	Modbus port, RJ45 connector Quantum 140 CPU 6●1	RJ45 connector	3 m	110 XCA 282 02	–
			6 m	110 XCA 282 03	–
			–	–	–

(1) Use the TSX CRJMD 25 mini-DIN/RJ45 cordset with converter TSX CUSB 485.



BMX XCA USB H0●●



TSX PCX 1031



TSX CUSB 485



## Presentation

Unity™ EFB Toolkit is the software for developing EF functions and EFB function blocks in C language and is optional software for Unity™ Pro. It can be used to develop new functions (whose internal code is written in C language) to extend and complete the set of functions proposed as standard in Unity Pro. This software comes with Microsoft Visual C++ @.Net® which can be used to debug the functions used on the Unity Pro PLC simulator. Unity EFB Toolkit also includes a service for creating and managing families of functions, with a view to their integration in the Unity Pro function libraries.

## Setup

C language development software is a proper tool for managing the whole function while it is being performed:

- A user-friendly creation interface, integrated in Unity Pro, with automatic file organization
- Powerful tools for testing and debugging
- Management of compatibilities and software versions of created functions
- Generation of files for subsequent installation of functions on other development stations

## Managing function families

The software can be used to define different function families. These functions, also known as EFs/EFBs, are stored in families, making it possible to create an organized library of functions written in C language.

Once created, these families can be distributed and integrated in the Unity™ Pro libraries.

They are:

- Arranged in families/functions
- Used in each language with the same flexibility as standard functions (data entry wizard)
- Managed by the Unity Pro library tool (version management)

## Editing functions

The various tabs in the EFB Toolkit software editor allow the user to create the function by:

- Declaring the interface, all data types are possible (elementary, structures, tables)
- Supporting public and private variables

## Writing the source code file in C language

A function written in C language can access numerous internal PLC services such as the real-time clock, PLC variables, system words, math functions. In particular, it is possible to perform numerical processing in floating point format.



**Setup (continued)**

**Debugging functions**

The function created can be tested after insertion in an application and loading into the Unity™ Pro PLC simulator.

The Microsoft® Visual C++® tool is used to debug the function.

It is used to:

- Insert breakpoints
- Perform step by step execution
- Display the code with the breakpoints visible
- Display manipulated data

**Note :** To generate the code for a Modicon M340 platform, a specific GNU compiler is used. It is supplied with the Unity™ EFB Toolkit.



**Enhancing the function library**

As the function has been debugged, it can be generated and distributed, and the updating tool supplied with Unity Pro can be used to enhance the libraries on a user station.

Version management means that at any time the user knows the level of functions installed on a station and can update the application with the latest existing versions.

**Compatibility**

Unity™ EFB Toolkit is compatible with Unity™ Pro Small, Medium, Large, and Extra Large.

Developing EF functions and EFB functions is possible with the Modicon® Premium™, M340™ and Quantum™ platforms.

**References**

The “companion” software for Unity Pro, Unity EFB Toolkit can be used to create EF elementary blocks and EFB elementary function blocks. These are developed in Visual C++ language and are integrated in Unity Pro function block libraries.

The Unity EFB Toolkit software and its documentation are supplied in electronic form on CD-ROM in English.

Description	Type of license	Language	Reference	Weight kg
Unity EFB Toolkit, kit for developing EF and EFB blocks	Single (1 station)	English (software and electronic documentation)	UNY SPU ZFU CD 30E	—



# Modicon® Premium™ automation platform

Unity™ software  
Unity™ SFC View

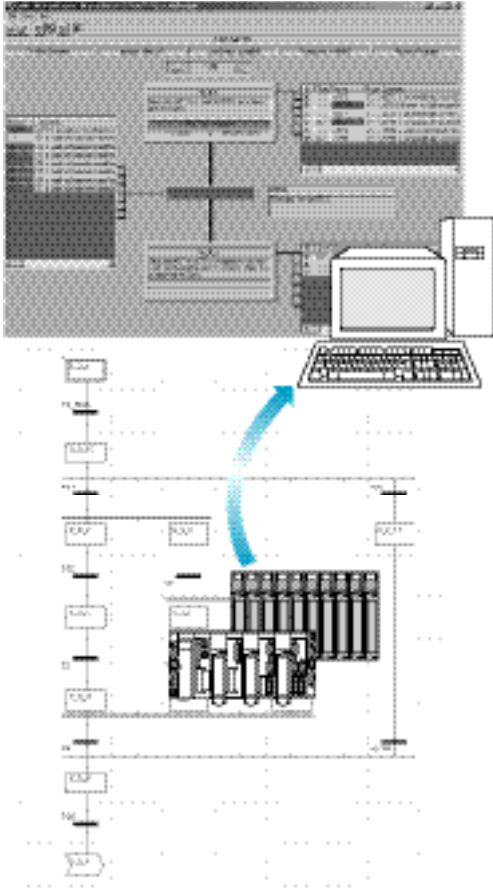

## Presentation

Unity™ SFC View is integrated in human/machine interface (HMI) applications for monitoring Unity™ Pro sequential applications written in sequential function chart language (SFC™ or Grafset™) executed by a PLC.

Set up in the same way as an ActiveX control component, Unity SFC View is used to display status information relating to SFC charts executed by a Modicon® Premium™, M340™ or Quantum™ PLC. Installed on an HMI station, Unity SFC View monitors and controls the status of SFC charts in real time, supplying detailed diagnostic data.

Unity SFC View reads the necessary data from the Unity project database in offline mode. The PLC data is accessed online via the OFS (OPC Factory Server).

Without needing to recreate SFC charts in the HMI environment, Unity SFC View reads the structure of the SFC charts directly from the Unity project database. Modifications made to the SFC application are detected and updated at any time. In online mode, Unity SFC View accesses the PLC diagnostic data, thus enabling awareness and tracking of the occurrence of the first detected fault and subsequent detected faults. System downtime is much reduced since Unity SFC View enables maintenance staff to locate the source of the problem much more quickly.

Unity SFC View is designed for end users and system designers who wish to integrate this control into their HMI system. Unity SFC View is compatible with most HMI platforms handling ActiveX Control components, such as Vijeo Look™ control software, or Monitor Pro™ supervisory software, or in a programming environment such as Visual Basic®.

#### The 3 views of Unity™ SFC View software

Unity™ SFC View offers 3 views:

- An overview for managing selection of SFC™ charts
- Two detailed views presenting the status and diagnostic data of the selected SFC chart



Overview

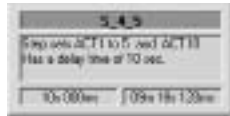

Simple detailed view

**The overview** provides a general view of the SFC charts in a Unity project. It contains real-time data such as current step, simultaneous steps, detected chart error with indication of the SFC chart status. The overview makes it easy to browse through SFC charts and switch quickly to the detailed view of the desired SFC chart in the Unity™ Pro application.

**The simple detailed view** shows the elementary data on the active step (or selected step) of the SFC chart in real time. The data displayed may include the name, comment, chart and step status, as well as the activity times (min, max, actual). You can also enable the chart navigation option.

Because of the compact size of the simple detailed view, it is possible to place several instances of it on a single HMI screen relating to a certain part of the process. From this simple detailed mode, you can navigate between HMI screens with SFC View controls and display the detailed view of SFC charts.



Detailed view

**The detailed view** illustrates the details of an SFC chart in real time. The display indicates the current step, the transition awaiting activation and the next step. The actions associated with the steps are displayed along with sequence selections or parallel branches. The detailed diagnostic data includes analysis of the causes of the detected fault at transition level. Depending on the diagnostic mode, the error grid contains the causes of detected errors or the variables assigned to the transition logic. The current state of the various variables and selected errors are identified by different colors.

#### Diagnostic mode

Transition logic diagnostics is a key function of Unity SFC View. It minimizes system downtimes in the event of a detected fault.

Two different diagnostic modes are available:

- Unity™ SFC View reads the data in the Unity™ PLC diagnostic buffer. It provides information about improper or missing events that are preventing the transition from being enabled. This mode does not require any configuration or additional programming in the PLC program.
- Unity™ SFC View monitors the internal logic of the transition conditions “back to front”. This mode provides diagnostic data concerning the inputs connected to the transition (not limited to inoperative inputs). In this mode, for Premium and Quantum platforms, Unity SFC View uses specific EFB function blocks linked to the transition conditions. The library for these blocks is supplied with the Unity SFC View software.

#### Customization

Unity SFC View offers a programming interface which can be used to integrate the ActiveX Control component in an HMI application and customize its functions and its operator interface.

The ActiveX Control component in Unity SFC View can be customized. It accepts properties, methods and events (the properties have a default value). The properties pages simplify configuration. Unity SFC View accepts scripts with methods such as browsing through charts, status control of charts, and also events such as detected error notification or chart selection. This data can be used to launch programs or operator screens.

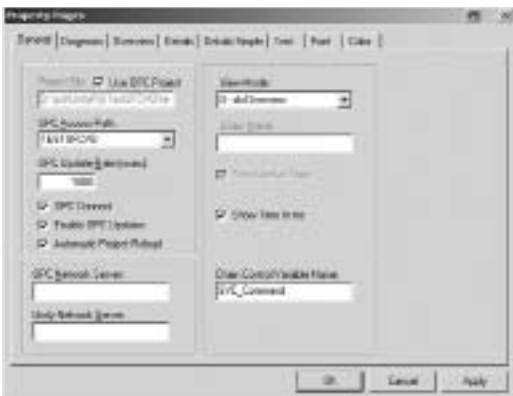

SFC View properties page

# Modicon® Premium™ automation platform

## Unity™ software

### Unity™ SFC View architectures

#### Possible architectures

##### Basic architecture

Unity™ SFC View is used in a configuration where the OFS™ and Unity™ Pro software reside on the same PC platform as the HMI application.

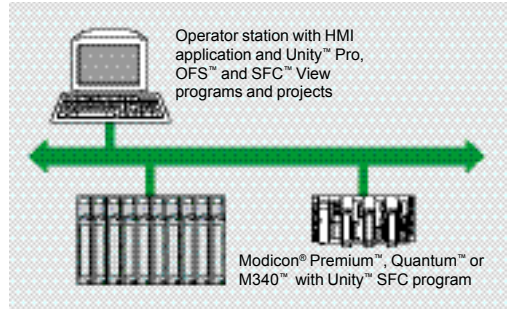

##### Distributed architecture

In a distributed configuration, the OFS™ and Unity™ Pro software can be installed on different servers.

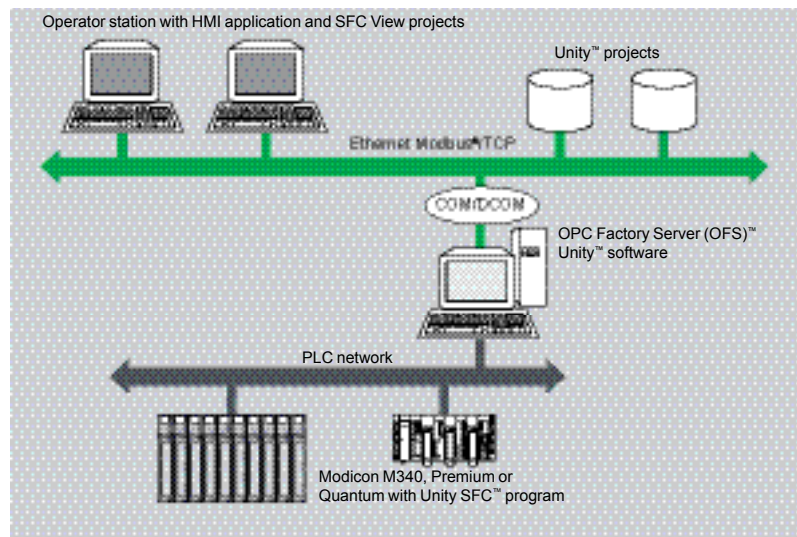



**References**

When integrated in an HMI application, Unity™ SFC View can be used to monitor and control charts in applications developed in Sequential Function Chart (SFC)™ language running on Premium™/Quantum™ Unity™ PLCs.

The HMI station, compatible with Windows 2000® or Windows XP Professional® operating systems, must support ActiveX Control components. Unity SFC View V2.0 requires:

- Unity™ Pro V3.● XL, to be ordered separately
- OFS V3.3 data server software, to be ordered separately

Unity SFC View multilingual software, supplied on a CD-ROM, includes:

- The SFC View ActiveX Control component
- The EFB function block library for Unity Pro V3.●
- An example of how to integrate SFC View in Unity Pro projects
- The electronic documentation (English, French and German)

The Unity SFC View integration example illustrates the main possibilities offered by Unity SFC View. This is an executable program which does not need HMI software in order to run. It helps the user understand how to configure and use the Unity SFC View ActiveX Control component.

Description	Type of license	Reference	Weight kg
<b>Unity SFC View software packages</b> (version V2.0)	Single (1 station)	<b>UNY SDU MFU CD20</b>	–
	Team (10 stations)	<b>UNY SDU MFT CD20</b>	–
	Site (100 stations)	<b>UNY SDU MFF CD20</b>	–



**Presentation**

Unity™ Dif application comparison software for Modicon® Premium™, Quantum™ and M340™ platforms is an optional program which complements the Unity™ Pro Extra Large programming software. It is used to compare two Unity applications generated by Unity Pro and automatically provide an exhaustive list of the differences between them.

The Unity Dif program increases productivity in the main life phases of a control system based on a M340/Premium/Quantum platforms:

- Application development and debugging
- Starting up installations and processes
- Operation and maintenance of installations and processes.

Unity Dif software is an efficient tool for handling Unity applications for:

- Control system design offices
- Operation and maintenance managers
- Installers and systems integrators.

**Software setup**

Unity™ Dif software can be used in one of two modes:

- Interactive mode, when the comparison is launched by an operator command (double-click on the Unity Dif software icon)
- Automatic mode, when it is launched by a previously established call command.

These comparison commands locate the differences between two applications in terms of:

- Hardware configuration (Modicon M340/Premium/Quantum)
- Network configuration (Ethernet TCP/IP network, CANopen bus and RIO remote I/O)
- Entire range of variables and function block instances
- Application structure and its content (regardless of the language(s) used)
- Function modules
- Code for the DFB user function blocks and DDT compound data
- Project options.

The result of the comparison between the two applications can be:

- Displayed
- Printed
- Saved in .txt format in a differences list.

**Comparison**

The end of the comparison operation is signalled by the appearance of the application browser with its two tabs.



1 Identification tab for accessing the characteristics of the two applications being compared. The differences are marked by the sign #

2 Browser tab for accessing the application multilevel tree structure.



(1) RIO remote I/O for Modicon Quantum platform.



## Setup (continued)

### Display of results

The representation of the application multi-level tree structure, which can be accessed via the browser tab after launching a comparison, is annotated by 4 symbols in which the information associated with application 1 appear in blue and those associated with application 2 appear in red:



This branch, found in this level of the tree structure, contains at least one difference



This block contains at least one difference



This section is only present in application 1



This section is only present in application 2

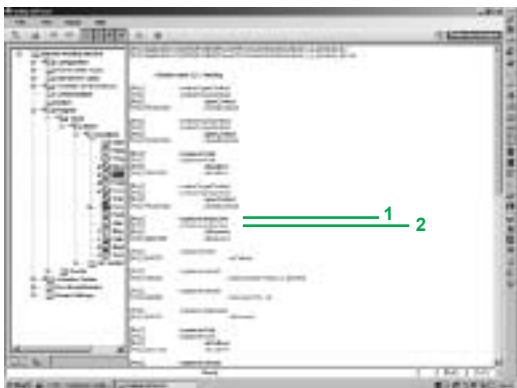

In the example opposite, a difference on the rung causing changeover to manual mode is detected:

1 This line displayed in blue belongs to application 1 [Prj1]

2 This line displayed in red belongs to application 2 [Prj2]

The source code extracts of both applications can be used to locate the differences precisely.

### Differentiation report

The "Report" command allows to generate the report file (.txt):

```

Completed Files:
-----
[Prj1] 2:\Test_MOD\TEST1.DP
[Prj2] 3:\Test_MOD\TEST2.DP

Date/Time of AppComparison : 2006/08/27 09:18:13
ModView Mode : 30-Display
Reference Version : 44-MOD3000000

First File : C:\TEST\3000\APP1\7_000
Name : 200004
Time : 4:18:52 AM
EOLN : 2007-0-04 (yyyy-mm-dd)
Time : 29 13:12 (MM:SS)
Version : 4.2.200
Product : Unity Pro L 32.0.0-000
Company : Schneider Automation
PLC Address : 01.01001.0000

Second File : C:\TEST\3000\APP2\7_000
Name : 200004
Time : 4:18:58 AM
EOLN : 2007-0-04 (yyyy-mm-dd)
Time : 29 13:12 (MM:SS)
Version : 4.2.200
Product : Unity Pro L 32.0.0-000
Company : Schneider Automation
PLC Address : 01.01001.0000

General Run-Off:
-----
Component          MODIFIED : 0          ADDED : 01          DELETED : 00
  Component         RE OCCURRENCES
  Extended Logic Tree MODIFIED : 12          ADDED : 01          DELETED : 04          MOVED : 0
  Extended PB Tree  MODIFIED : 09          ADDED : 01          DELETED : 0
  Extended FB Tree  MODIFIED : 0
  Control Cabinet   RE DIFFERENCES
  Motor            MODIFIED : 44          ADDED : 0          DELETED : 0          MOVED : 0
  Program          MODIFIED : 48          ADDED : 81          DELETED : 75
  Function Block Diagram MODIFIED : 00          ADDED : 00          DELETED : 00          MOVED : 0
  Ladder Diagram   MODIFIED : 00          ADDED : 00          DELETED : 00          MOVED : 0
  Distribution List RE OCCURRENCES
  Sequential Function Chart MODIFIED : 0          ADDED : 00          DELETED : 00          MOVED : 0
  Annotation Tables MODIFIED : 0          ADDED : 0          DELETED : 0          MOVED : 0
  Function1 Module  RE OCCURRENCES
  Project Settings  RE OCCURRENCES

Non-Compared part(s) :
-----
Filters :
  Item : 1, 2, 3, 4
  All Item : 0

Report in Tree View:
-----
| 200004
| |--Component
| |--Extended Logic Tree
| |--Extended PB Tree
| |--Extended FB Tree
| |--Control Cabinet
| |--Motor
| |--Program
| |--Function Block Diagram
| |--Ladder Diagram
| |--Distribution List
| |--Sequential Function Chart
| |--Annotation Tables
| |--Function1 Module
| |--Project Settings
  
```

## Reference

This software extension is used to compare two PL7™ applications generated by Unity™ Pro software version ≥ V2.1

Function	Target extension PLC target	Type of device	Reference	Weight kg
Unity™ Dif application comparison software extension CD-ROM containing software and electronic documentation (English-French)	Unity™ Pro Extra Large Modicon® M340™/ Premium™/ Quantum™	Single (1 station)	UNY SDU DFO CD20	—

# Modicon® Premium™ automation platform

## Unity™ software

### Unity™ Application Generator (UAG)



#### Advanced design tool for automation solutions

Deliver your automation projects faster and re-use your know how! Unity™ Application Generator (UAG) is an advanced design and generation software tool that integrates multiple PLCs and HMI/SCADA systems to provide an automation solution similar to a Distributed Control System. Using an approach based upon reusable objects (Application Libraries) and automatic application generation, UAG helps to ensure consistent design and implementation of user-defined standards & specifications. Providing change tracking and automatic documentation, UAG supports standards including ISA-88 and GAMP.

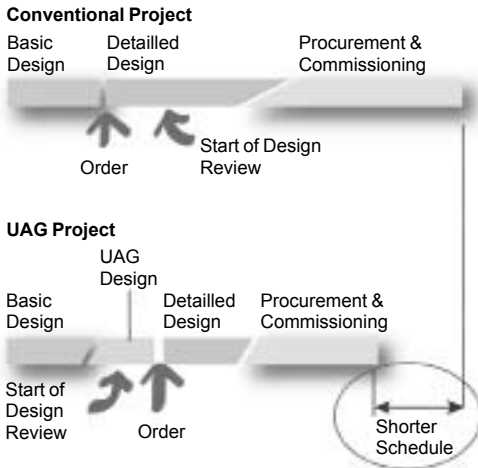

#### Business Advantage

UAG provides significant business advantages in terms of cost reduction, quality and performance improvement.

- **Cost**
  - savings in system implementation cost,
  - improved time-to-market for the end-user by allowing the project to go live and get a return on investment sooner.
- **Quality**
  - improved software quality,
  - improved maintainability,
  - reduced risk and improved project schedules.
- **Performance**
  - standardized design and systematic improvement,
  - capture and re-use of your best practices.

#### Working efficiently

UAG provides the key features for an advanced automation solution to increase efficiency and share and re-use your know-how.

**Structured Project Design** - bridge from the process engineer to the control/automation designer (from the P&ID to the automation system). Capture and re-use of the Customer's best practices within **application specific libraries** that reduce the dependency on experts, enable standardization and increase software robustness. **Single Database** entry avoids duplicate effort and resulting errors. **Automatic Application Generation** including the **automatic configuration of networks** in multi device systems increases efficiency, improves software quality, speeds commissioning while simultaneously **reducing project risk**. Integrated **change tracking** and **automatic documentation generation** reduces engineering effort and enables system validation.

#### Advanced Automation platform

UAG integrates best-in-class products from Schneider Electric and leading partners into an advanced automation platform based on standards, including **ISA-88**, **GAMP**, **IEC 61131-3**:

- Premium™/Quantum™ PLCs.
- Premium I/O, Quantum I/O, Momentum™ I/O, Advantys™ I/O.
- Leading HMI/SCADA systems including Vijeo® Citect® and Monitor Pro™.
- Modbus® TCP/IP communication.
- OPC data server software (OFS)™.
- Fieldbus support.

Single data point entry and management integrates the process control, monitoring and supervision and helps to ensure data consistency and integrated communication between all devices.



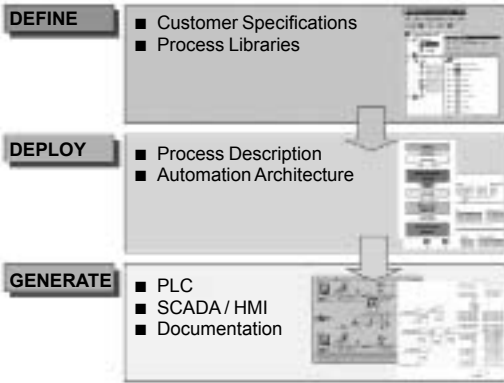

## Working with UAG

### Methodology

UAG enables you to capture and re-use your know-how.

Your standards, rules, instructions, configurations and naming convention are defined in the UAG library. Using UAG, OEMs and System Integrators can deploy their standards easily and consistently.

Through automatic generation, the project information is propagated to applications consistently, easily and quickly.

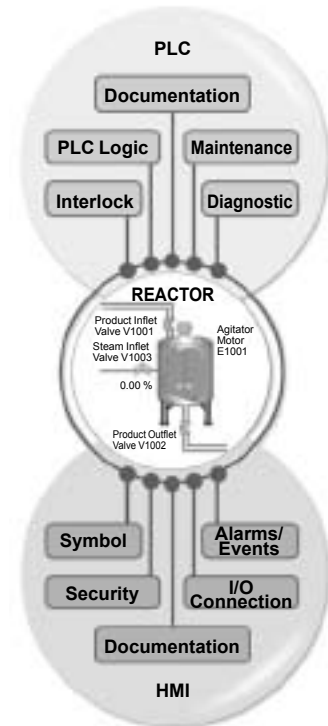

### Creating user libraries

Libraries are based on re-usable control devices - **Smart Control Devices (SCoDs)**.

SCoDs are versatile, multi-faceted objects describing the functional, control, supervisory and configuration aspects of your process elements.

Based on control logic (DFB/EFB) and its graphical description (symbol), the definition of control devices is enhanced and organized in libraries. Existing control logic / symbols can be used directly.

The SCoDs encapsulate **your** standards and rules. They are pre-qualified and deployed according to the UAG methodology. A simple parameterization allows the usage within the project, automatically taking care of the application and device specific context including communication definitions.

### Structuring your project

A Structured Project Design - bridge from the process engineer to the control automation designer (from the P&ID to the automation system) based on the ISA-88 standard. The P&ID drawing is mapped to the physical model in UAG.

This process can be automated through import functions providing UAG the specific parameterization of the model.

- PLC related requirements:
  - location of devices and functions,
  - interlocking,
  - data communication.
- HMI/SCADA related requirements:
  - process visualization,
  - operator control,
  - logging, trends, alarms...

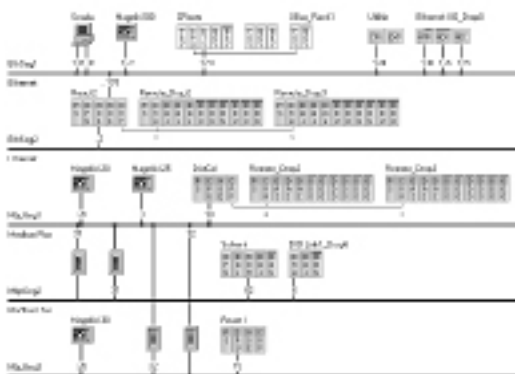

### Multi-station automation configuration

Inside UAG the entire process controls, monitoring and supervision topology of the distributed automation system is managed.

Global resources for networks and communication are managed. Device specific resources like I/O definition and address management are also automatically configured.

No platform or application specific expert knowledge is required. UAG translates the customer requirement into the automation solution.

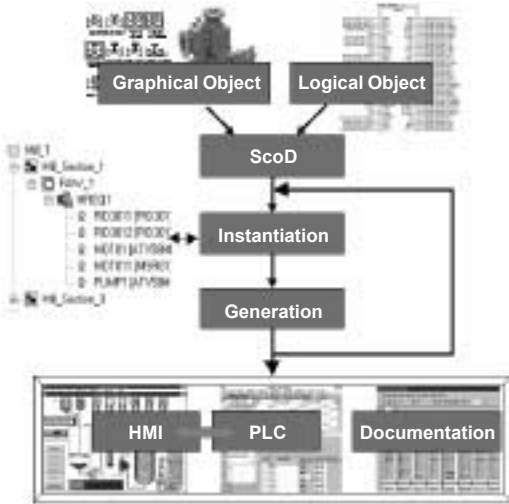

## Working with UAG (continued)

### Generating the application

Based on the structured design and your standards contained within the pre-qualified UAG library, the automation solution is generated helping to ensure consistent information for the PLCs and the HMI/SCADA. The resources (addresses, name space...) are used in an optimized mode without conflicts or errors.

UAG can generate complete projects and also **incremental changes** when modifications occur.

- For the PLC:
  - variables,
  - IEC 61131-3 compliant logic,
  - I/O configuration,
  - communication.
- For the HMI/SCADA the complete server and client application :
  - screens,
  - symbols,
  - variables,
  - trends and alarms,
  - access attributes (security, access).
- Complete pre-configured and optimized communication between devices and the HMI/SCADA:
  - Modbus® TCP,
  - OPC data server software (OFS)™.
- Documentation and change tracking:
  - automatic documentation of the application,
  - change tracking supporting FDA compliancy.

### Validation

UAG simplifies validation when required by regulation or to comply with GAMP (Good Automation Manufacturing Practice).

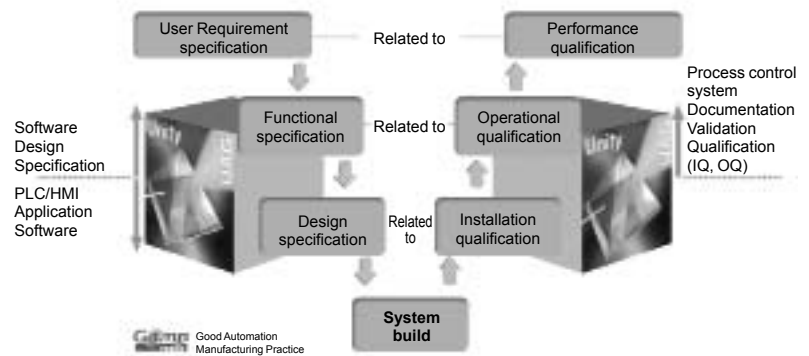

UAG uses ISA 88 standard terminology for batch control and supports the GAMP methodology for creating an automation system.

The use of these two standards is a key element to achieve process validation.

In addition, UAG provides:

- Process information at a single point, based on functional analysis.
- Automatic generation of process applications by UAG.
- Archiving which supports 21 CFR 11 compliance.
- A log of interactions by UAG.
- Electronic documentation.

## Working with UAG (continued)

### Basic Libraries

A Basic Library is available providing sample SCoDs as a template to develop your library. Basic functions include:

- Input/Output processing,
- motor (1/2 speed, 1/2 directions),
- valves (Mono, Bistable, proportional),
- control (PID),
- Schneider Electric devices (Altivar®, Tesys U®),
- PLC Status.

### Segment/Application specific libraries

A number of more specialized libraries have been developed which provide a more complete starting point for the projects, for example:

- Water.
- Cement.
- Metal processing.



### Supported platforms

#### ■ PLC Software

- Unity™ Pro V2.3 or higher,
- Concept™ V2.6 or higher.

#### ■ PLC Hardware

- Premium™, Quantum™,
- Premium I/O Quantum I/O, Momentum™ I/O, Advantys™ STB I/O,
- Modbus®-TCP, Modbus+.

#### ■ HMI / SCADA

- Monitor Pro™ V7.2 /V7.6,
- Vijeo® Citect®,
- other HMI/SCADA via the UAG "Plug-In" interface.

#### ■ Export of information for other devices / applications

- XML export file,
- CSV export file.



## References

This specialized software program UAG (Unity Application Generator) is multilingual (available in English, French and German) and compatible with the Windows 2000 Professional® and Windows XP® operating systems.

Documentation is supplied in electronic format.

The PLC/SCADA programming tools and/or communication driver must be ordered separately.

### UAG software suites

Description	License type	Reference	Weight kg
UAG software suites (Unity Application Generator)	Single (1 station)	UAG SEW LFU CD30	–
	Site (> 10 stations)	UAG SEW LFF CD30	–

### UAG process application library for Vijeo® Citect®

Description	License type	Reference	Weight kg
Process application library V1.0 for Vijeo Citect 6.10 and Vijeo Citect 7.0	Unlimited installation. Requires subscription.	UAG SBT XFT CD10	–

#### Two Unity™ Pro process control offers

##### User-definable control loops

This offer of user-definable control loops is integrated as standard in Premium™ TSX™ 57 2●/3●/4●/5●/6● platforms with Unity™ Pro Medium, Large, Extra Large and XLS software.

This offer is identical to that offered with PL7™ Junior/Pro, except for the runtime screens.

See pages 6/53 and 6/57.

##### Programmable control loops

The process control offer for Premium TSX 57 2●/3●/4●/5●/6● platforms with Unity Pro Medium, Large, Extra Large and XLS software has been enhanced with the new programmable offer.

This offer is based around the EF and EFB function block library specific to process control. More than 30 blocks are available, classified in 6 families:

- EFB blocks for data preparation (for example, DTIME, INTEGRATOR, SCALING, etc)
- Controller EFB blocks (for example, AUTOTUNE, PIDFF, SAMPLETM, etc)
- Math EF blocks (for example, COMP\_DB, MULTIV\_M, SUM\_W, etc)
- Measurement processing EF/EFB blocks (for example, LOOKUP\_TABLR1, HYST\_●●●, AVGMV, etc)
- Output value processing EFB blocks (for example, PWM1, SERVO, etc)
- Reference value processing EFB blocks (RAMP, RATIO, SP8SEL)

These blocks manage operating modes such as tracking, manual/automatic mode and process control algorithms on cyclic values (intervals between two consecutive sampling operations).

See pages 6/58 and 6/59.

### User-definable process control

The process control offer integrated as standard in Premium™ platforms can be used to set up and debug machine control-oriented control loops in Unity™ Pro Large and Extra Large.

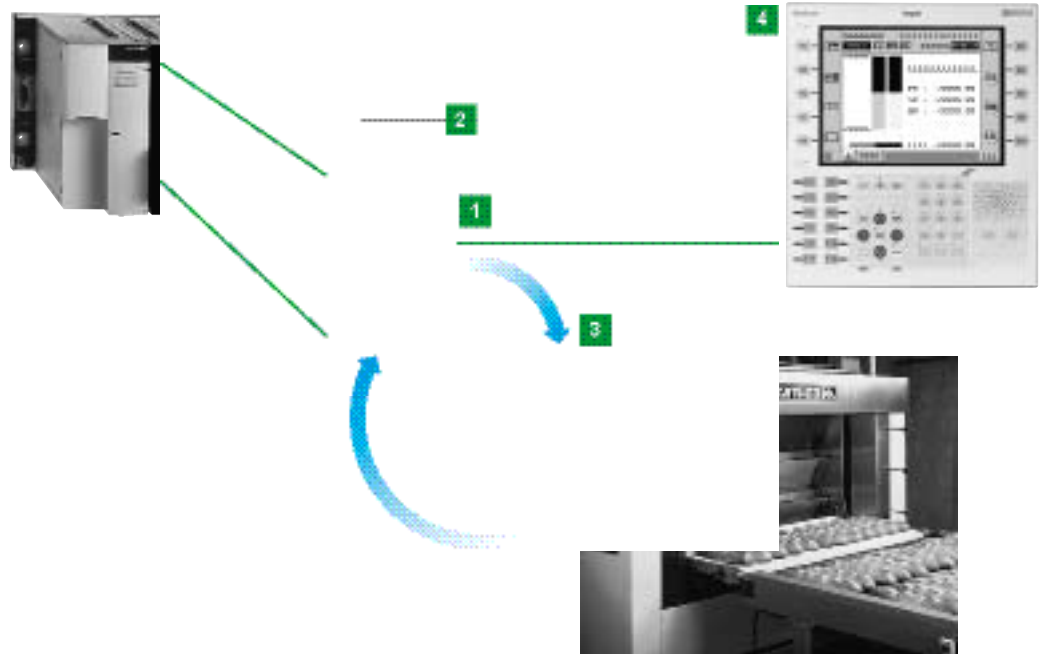

### User-definable process control functions

TSX™ P57 2●4/2634/3●4/3634/454/4634/554/5634/6634M CPUs and TSX™ PCI 57 204/354M slot PLCs make it possible, depending on the model, to manage between 10 and 30 process control channels (of 3 loops each). These channels can be configured to execute algorithms for industrial processes:

- Cascaded loop
- Process loop
- Autoselective loop
- Setpoint programmer
- Controller with three simple loops

### Inputs/Outputs

TSX P57 2●4/2634/3●4/3634/454/4634/554/5634/6634M CPUs and TSX PCI 57 204/354M slot PLCs manage an entire station consisting of racks connected on Bus X.

The I/O interfaces required for process control processing operations are analog or discrete channels in:

- "In rack" I/O modules
- TBX, Advantys™ STB or Momentum™ distributed I/O modules

### Control loops

Software setup of the control loops is user-definable (Plug and Play technology) during configuration of the Premium CPU.

The user enters information in the predefined loop diagrams which also integrate management of operating modes and the link with the I/O.

**Presentation (continued)**

**TSX™ P57 2●4/2634/3●4/3634/454/4634/554/5634/6634M** CPUs and **TSX™ PCI 57 204/354M** slot PLCs offer the possibility of configuring 10, 15, 20 or 30 control channels for continuous or semi-continuous processes.

The process control functions offered by these CPUs are particularly suitable for:

- Sequential processes requiring auxiliary process control functions such as packaging machines, surface treatment machines, presses, etc
- Simple processes such as metal treatment furnaces, ceramic ovens, refrigeration units
- Servo-control systems or mechanical process control where the sampling time is critical, such as torque control, speed control, etc

Premium™ CPUs include the following characteristics:

- Each configurable process control channel can be used to manage 1 to 3 loops depending on the type of loop selected
- Process control processes can be inserted in the overall architecture of a site, thanks to the integration of the PLC in different communication networks
- Process control-related calculations are performed in floating point arithmetic expressed in physical units.

Description and characteristics: **TSX P57 ●●4/●●34M** CPUs, see pages 1/6 to 1/11; **TSX PCI 57●●4M** slot PLCs, see pages 1/16 to 1/20.

**Functions**

**Control loops**

Premium CPUs can be used to set up 10 to 30 process control channels, each adopting one of the following 5 control profiles:

- Process-type loop: loop with a single controller
- Controller with 3 simple loops: controller used to increase the capacity of the number of loops
- Autoselective loop, also called secondary loop: consisting of 2 loops in parallel with an algorithm for selecting the output
- Cascaded loop: consists of 2 dependent loops (the master loop output is the slave loop setpoint)
- Setpoint programmer: consisting of a maximum of 6 composite profiles, with a total of 48 segments

As the channels are independent, configuration of 10 channels can be used for example to obtain:

- 30 simple loops
- 5 setpoint programmers, each associated with 5 control loops
- 2 setpoint programmers and 8 process loops

The various loops are characterized by:

- Their different algorithms
- 5 processing branches (measurement, setpoint, Feed Forward, controller and output processing)
- Calculation functions (gain, filtering, square root, etc) defined using parameters.

**Types of control loop**

Predefined algorithms can be defined by the user and are represented as shown below:

**Process loop**

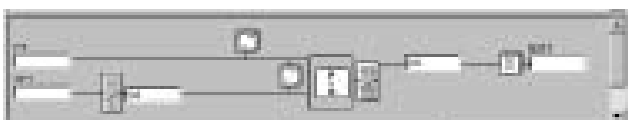

**Simple loop**



**Autoselective loop**

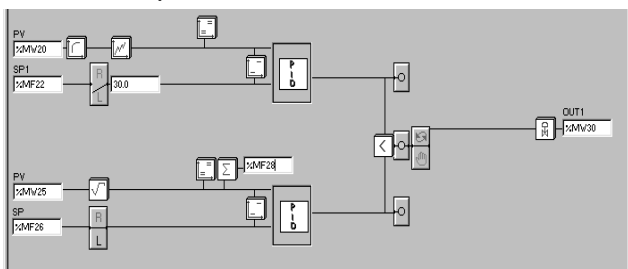

**Cascaded loop**

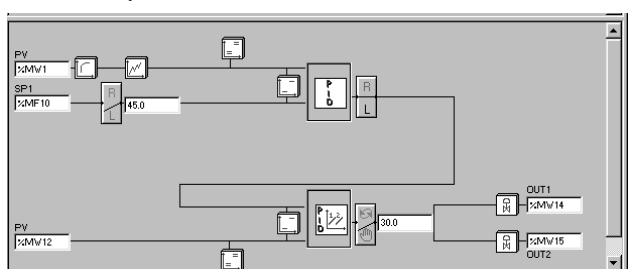



## Processing branches

Parameter-setting (selection of the functions to be used) of the control loop profiles can be used to adapt the algorithm to the process to be controlled.

## Measurement processing

Measurements can be processed either in the standard way or externally.

- **Standard processing:** The user can access the following functions: filtering, setting measurement between limits, function generator with scaling, management of alarms on threshold overshoot, totalizer and simulation of the measured value.
- **External processing:** This means there can be a process value PV at the controller input which has been processed outside the control loop. This is a handy solution if calculation of the measurement requires special or customized functions.

## Setpoint processing

Depending on the type of loop selected, it is possible to opt for one of the following 4 types of setpoint: ratio setpoint, selection setpoint, simple setpoint (“remote” with scaling) or setpoint programmer.

In the case of the controller with 3 simple loops or the secondary loop (in an autoselective loop), only the simple setpoint and the setpoint programmer can be used.

## Feed Forward processing

Feed Forward processing can be used to compensate for a measurable disturbance as soon as it appears. This open loop processing anticipates the effect of the disturbance. It features the “Leading” function (lead/lag phase).

## Controller and command processing

The controller can be chosen from the following 6 types: Self-tuning PID, controller in discrete mode with 2 or 3 states, hot/cool controller (PID or self-tuning model) or Split Range controller (PID or self-tuning model).

## Output processing

There are 3 types of output which can be processed: analog output, servomotor output or PWM output. Whatever the type of output, the command calculated by the controller crosses a gradient limiter and a limiter whose upper and lower limits are used to define the output variation range.

## Setpoint programmer

The setpoint programmer offers a maximum of 6 profiles consisting of a total of 48 segments. It is thus possible to create various programmer/segment configurations, e.g. one programmer with 48 segments, 6 programmers with 8 segments or one programmer with 24 segments plus one programmer with 16 segments and one programmer with 8 segments, etc.

Each segment is configured as either a ramp or dwell step. It is characterized by:

- The setpoint to be reached
- The duration of the segment or slope of the segment (if it is a ramp)

A profile can be executed once, a certain number of times or looped continuously. In addition, the concept of a specified dwell step means the time is only counted down if the measurement is definitely within the specified range.

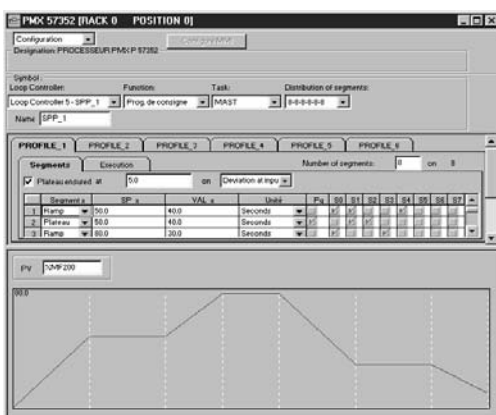

### Configuring process control channels

Special screens, accessible using Unity™ Pro software, can be used to configure control loops.

#### Configuring process control channels:

The “Loops” interface in Premium™ CPUs simplifies configuration by offering simple selections from menus:

- The type of loop from 5 options
- The choice of functions used in the 5 processing branches
- The parameters linked to each of the functions
- The assignment of PLC variables to the different loop branches (memory words, input words or output words depending on the processing branch)
- Automatic presymbolization of the variables used in loops

When configuring process, simple, autoselective and cascaded loops, default parameter settings are offered. The various functions integrated in the algorithms (square root, function generator, etc) and the initial value of each parameter are predefined.

#### Example: Configuring a process loop

Once the type has been chosen, its parameters can be set by selecting or deselecting the options in the processing branches. No programming is therefore necessary, the loop diagrams are enhanced or simplified as and when the parameters are validated. Opposite, selecting the PID controller enables display of the various valid parameters for this type of controller (KP, TI, TD, etc).

In the case of the setpoint programmer, the different profiles (6 maximum) are configured via a table defining each segment.

After selecting the type of segment (ramp or dwell step), its configuration consists of defining the setpoint to be reached (with the ramp) and the duration (for the ramp or dwell step).

As selections are made, the bottom of the screen displays the profile with the setpoint limit values.

This screen can also be used to define the cycles for this profile: execution once, a certain number of times or looped continuously (32,767 times maximum).

### Executing process control channels

The sampling period for the loops is predefined at 300 ms. This defines the controller processing period in automatic mode. It is possible to modify this period in the loop configuration screen.

The I/O and the parameters of the various configured process control channels can be accessed by the user at program level or via the various Unity Pro software tools (especially language editors and animation tables).

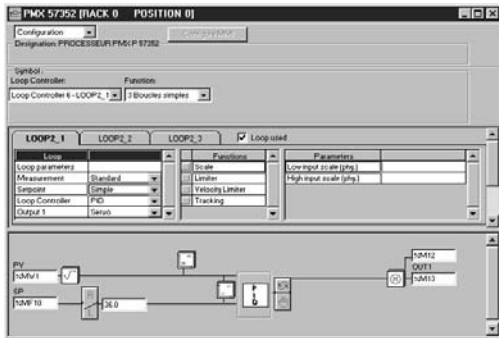

Configuring process control channels

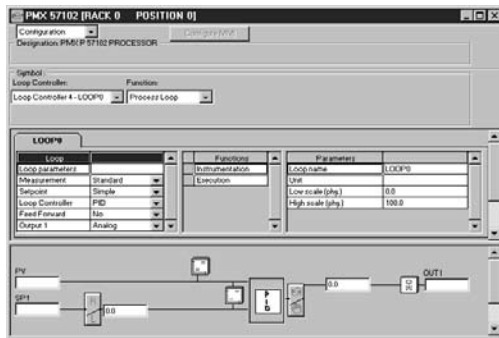

Configuring a process loop

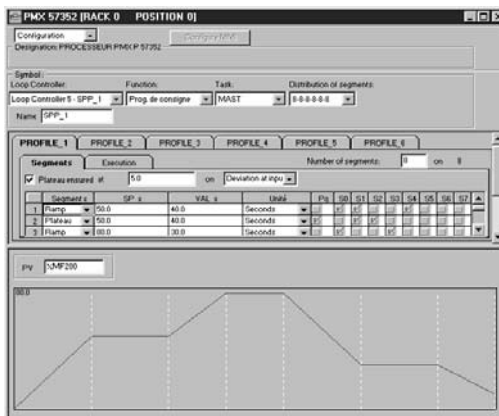

Defining profile cycles

## Debugging functions

Adjusting and debugging control loops is simple and user-friendly via, for example, the application-specific loop configuration screen which, in online mode, provides access to the following functions:

- Display and animation of the loop algorithm diagram
- Display of process alarms and channel faults
- Simulation of the input interface values: for example when these are not connected (measurement, Feed Forward)
- Addition, deletion or replacement of calculation functions in online mode
- Modification of the adjustment parameters for each of the functions
- Modification of the controller operating modes and manual control mode

With the controllers integrated in the control loops, it is possible to use the autotuning function which calculates a set of adjustment parameters ( $K_p$ ,  $T_i$ ,  $T_d$  or  $K_s$ ,  $T_1$ ,  $T$ -delay) on request.

Once the loop has been debugged, it is possible to save the current values resulting from the tests in the initial loop parameters values. This means that, on restarting the loop, it will start off with the correct values.

## Debugging a loop

The debug screen can be used to:

- Display the values of the variables linked to the loop in real time
- Know which parameters have been selected (and even modify them)
- Display alarms

The menus can be used for manual control of the loop, autotuning, parameter backup, etc.



Debugging a loop

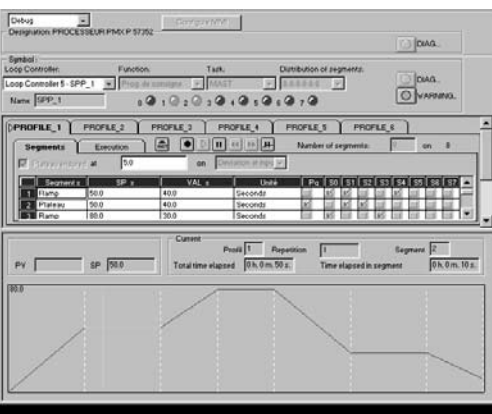

Debugging the setpoint programmer

## Debugging the setpoint programmer

The setpoint programmer channels have their own debug screen which can be used to display:

- The number of the active segment and the iteration
- The execution time for the active segment
- The overall execution time

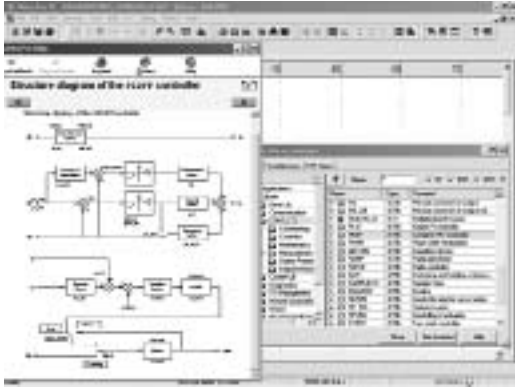

CONT\_CTL, programmable process control integrated in Unity Pro

### Process control in machines

Unity™ Pro contains CONT\_CTL, a library of 36 function blocks used to create control loops for machine control.

Requirements for closed loop control functions in machines are adequately met by Modicon® Premium™, Quantum™ and M340™ platforms, thanks to the wealth of functions in the library and the flexibility with which function blocks can be linked together through programming. This solution therefore eliminates the need for external controllers, and simplifies the overall control architecture of the machine, as well as its design, roll-out and operation.

The function blocks, EF or EFB, can be used in Unity Pro languages i.e. LD, ST, IL and FBD. FBD is particularly suitable for accessing control processing operations in Unity Pro through its assistant for entering and viewing parameters and function block variables.

### CONT\_CTL library functions

The library consists of five function families:

- Input data conditioning
- Controllers
- Math functions
- Measurement processing
- Output value processing

#### Input data conditioning

DTIME	Pure delay
INTEGRATOR	Integrator with limiting
LAG_FILTER	First order time lag device
LDLG	PD device with smoothing
LEAD	Differentiator with smoothing
MFLOW	Mass flow calculation based on the measurement of differential pressure or flow speed with pressure and temperature compensation
QDTIME	Deadtime device
SCALING	Scaling
TOTALIZER	Integrator (typically of flow) until a limit (typically a volume) is reached, with automatic reset
VEL_LIM	Velocity limiter, with manipulated variable limiting

#### Controllers

PI_B	Simple PI controller: PI algorithm with a mixed structure (series/parallel)
PIDFF	Complete PID controller: PID algorithm with a parallel or mixed structure (series/parallel)
AUTOTUNE	Automatic tuner setting for the PIDFF (complete PID) controller or the PI_B (simple PI) controller <ul style="list-style-type: none"> <li>□ Identification using Ziegler Nichols type method</li> <li>□ Modeling based on 1<sup>st</sup> order process</li> <li>□ Building of control parameters with criterion for prioritizing either the reaction time to disturbance (dynamic) or the stability of the process</li> </ul>
IMC	Model corrector. The model is a first order model with delay. This corrector is useful: <ul style="list-style-type: none"> <li>□ When there are serious delays compared with the main time constant of the process; this scenario cannot be satisfactorily resolved by standard PID process control</li> <li>□ For regulating a non-linear process</li> </ul> IMC can handle any stable and aperiodic process of any order.
SAMPLETM	Control of controller startup and sampling
STEP2	Two-point controller
STEP3	Three-point controller for temperature regulation

#### Math functions

COMP_DB	Comparison of two values, with dead zone and hysteresis
K_SQRT	Square root, with weighting and threshold, useful for linearization of flow measurements
MULDIV_W	Weighted multiplication/division of 3 numerical values
SUM_W	Weighted summation of 3 numerical values

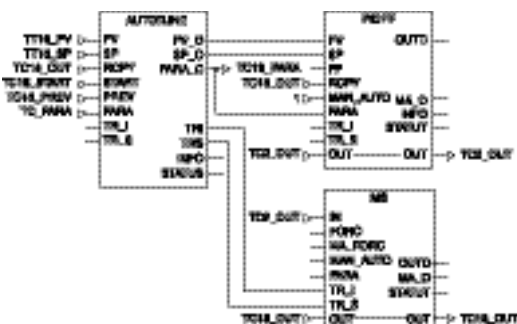

Example: PID controller with MS manual control

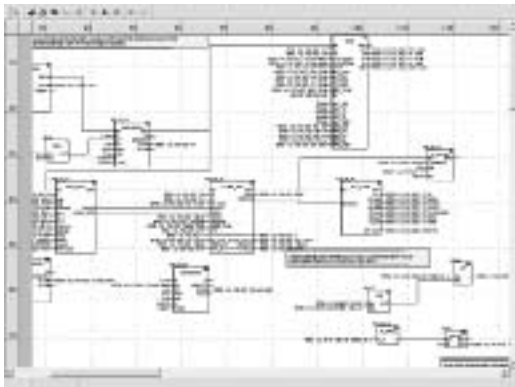

Programming in Unity Pro in offline mode

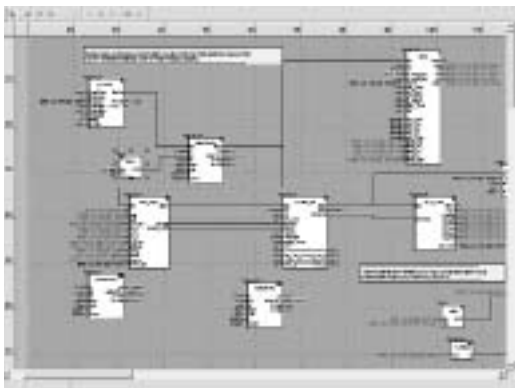

Programming in online mode

### CONT\_CTL library functions (continued)

#### Measurement processing

AVGMV	Moving average with fixed number of samples (50 max.)
AVGMV_K	Moving average with constant correction factor, 10,000 samples max.
DEAD_ZONE	Dead zone
LOOKUP_TABLE1	Linearization of characteristic curves using first-order interpolation
SAH	Detection of a rising edge
HYST_XXX	Detection of high threshold with hysteresis (1)
INDLIM_XXX	Detection of high and low thresholds with hysteresis (1)

#### Output value processing

MS	Manual control of an output
MS_DB	Manual control of an output with dead zone
PWM1	Control via pulse width modulation
SERVO	Control for servo motors
SPLRG	Control of two <i>Split Range</i> actuators

#### Setpoint management

RAMP	Ramp generator, with separate ascending and descending ramps
RATIO	Ratio controller
SP_SEL	Selection of setpoint value: local (operator) or <i>remote</i> (processing)

### Setup

#### Setting up process control function blocks

Based on the sequencing of function blocks, the FBD language integrated into Unity™ Pro is a programming language particularly suitable for building control loops. Designers can use FBD to easily associate blocks from the CONT\_CTL library with their own DFB blocks written in Unity Pro's ST, IL or LD language, or in C language.

#### Debugging, operation

Unity Pro's standard debugging services (see page 6/23) are available. In particular, the Modicon M340 processor simulator can be used to check correct execution of processing offline.

#### Compatibility

The CONT\_CTL control function block library is available in each version of Unity Pro. It is compatible with processors in the Modicon® Premium™, M340™ and Quantum™ ranges.

#### Resources

The technical documentation provides many examples of how to set up programmable process control function blocks in FBD, LD, IL and ST languages.

The techniques for adjusting process control loops are described in the document "Process control, Unity V3.0" available on the [www.schneider-electric.com](http://www.schneider-electric.com) website.

(1) XXX depending on the type of variable: DINT, INT, UINT, UDINT, REAL

PL7™ programming software for Modicon® Premium™ CPUs P and TSX Micro™ PLCs M



6

<b>Languages</b>	Instruction List (IL) Ladder (LD) Structured Text (ST) Grafcet™ (SFC)™ Grafcet with macro-steps (SFC)
<b>Programming services</b>	Multi-task programming (master, fast and event-triggered) Functional view and function modules DFB editor Use of DFB instances EF function libraries Configurable control loops User-definable control loops Warm Standby PLC redundancy system System diagnostics Application diagnostics
<b>Debugging and display services</b>	Step by step execution, breakpoint Runtime screens Diagnostic viewers
<b>Other services</b>	PL7™ 2 application converters PL7™ 3 and Orphee application converters Utilities for updating PLC operating systems Communication drivers for Windows 2000/XP®

M	P - M	M
M	P - M	P - M
M	P - M	P - M
M	P - M	P - M
	P	P
M	P - M	P - M
		P
		P
	P	P
M	P - M	P - M
M	P - M	P - M
	P (TSX P57 2●/3●/4●)	P (TSX P57 2●/3●/4●)
		P (TSX P57 353/453M)
M	P - M	P - M
		P - M
M	P - M	P - M
		P - M
		P - M
M	P - M	P - M
	P - M	P - M
M	P - M	P - M
M	P - M	P - M

<b>Compatible Modicon® platforms</b>	Premium™ CPUs P  TSX Micro™ PLCs M
--------------------------------------	--

–	TSX™ P57 1● TSX P57 2● TSX P57 3● TSX P57 4●	TSX P57 1● TSX P57 2● TSX P57 3● TSX P57 4●
TSX™ 37 05/08/10/21/22	TSX 37 05/08/10/21/22	TSX 37 05/08/10/21/22

<b>Software name</b>	
<b>Unity™ Pro software type</b>	
<b>Pages</b>	

<b>PL7™ Micro</b>	<b>PL7™ Junior</b>	<b>PL7™ Pro</b>
TLX CD● PL7M ●44M	TLX CD● PL7J ●44M	TLX CD● PL7J ●44P
6/76 and 6/77		

EF function development software in C language	Development of applications in C language	Comparison of PL7™ applications	Availability of control systems based on Premium™ platforms
--	---	---------------------------------	---

<p>Enhancement of EF function block libraries:</p> <ul style="list-style-type: none"> <li><input type="checkbox"/> Creation of families</li> <li><input type="checkbox"/> Development of functions in C language</li> <li><input type="checkbox"/> Access to math calculation functions in floating point format</li> <li><input type="checkbox"/> Debugging functions (step by step, breakpoint)</li> <li><input type="checkbox"/> Use of functions created in each language</li> </ul> <p>Supplied with Microsoft Visual C++®</p>	<p>Development for processing process applications using fuzzy logic:</p> <ul style="list-style-type: none"> <li><input type="checkbox"/> 25 linguistic rules for redefining expert knowledge using conditions/conclusions (If...Then)</li> <li><input type="checkbox"/> Description of membership functions</li> </ul> <p>Screens for simulation in offline mode and debugging in online mode.</p>	<p>Automatic comparison of 2 Premium applications with identification of differences.</p> <p>Requires PL7™ Pro software</p>	<p>Continuity of operation in a Premium redundant PLC architecture. Provides access to shared I/O on the Fipio bus or redundant I/O. Typical "Normal/Standby" switching time: 1 to 2 s</p>
---	---	---	--

<p>Compatible with:</p> <ul style="list-style-type: none"> <li><input type="checkbox"/> PL7™ Pro</li> <li><input type="checkbox"/> TSX Micro™/Premium™ CPUs</li> </ul>	<p>Compatible with:</p> <ul style="list-style-type: none"> <li><input type="checkbox"/> PL7 Pro</li> <li><input type="checkbox"/> TSX Micro/Premium CPUs</li> </ul>	<p>Compatible with:</p> <ul style="list-style-type: none"> <li><input type="checkbox"/> PL7 Pro</li> <li><input type="checkbox"/> TSX Micro/Premium CPUs</li> </ul>	<p>Compatible with:</p> <ul style="list-style-type: none"> <li><input type="checkbox"/> PL7 Pro</li> <li><input type="checkbox"/> TSX P57 353/453M CPUs</li> </ul>
--	---	---	--

<b>SDK C</b>	<b>PL7™ FUZ</b>	<b>PL7™ DIF</b>	<b>Warm Standby</b>
<b>TLX SDKC PL7 41M</b>	<b>TLX L PL7 FUZ 34M</b>	<b>TLX CD● PL7 DIF 42</b>	<b>TLX CD WSBY P40F</b>
6/79	6/81	6/83	4/74

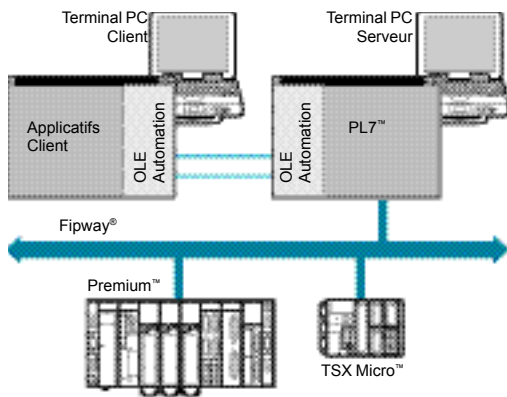

## Presentation

PL7™ Micro/Junior/Pro software packages are designed for Windows 2000® Professional and Windows XP® (1) operating systems, providing advanced functionality to a wide range of facilities.

PL7™ version 4.4 enables new Modicon® Premium™ TSX Micro™ modules to take advantage of additional functionalities:

- PL7 software registrations by the Internet, electronic mail, fax or phone (obligatory registration before 22nd day).
- Change in the Fipio® catalog for Momentum™ distributed I/O.
- Transfer of PL7 user rights between PCs via floppy disk or network.
- Enriched export files of the data application (FEF) for better compatibility with Unity™ software after migration.

PL7 Micro Junior/Pro software packages are offered according to two alternatives depending on the type of PLCs/PC cable: connection on the RS 232C port, or the USB port of a PC.

## Ergonomics of the software

PL7™ offers more user-friendly and productive ergonomics thanks to:

- Access to contextual menus by right-clicking with the mouse for fast access to the services available for the selected object.
- Contextual help: direct access to help corresponding to the selected object.
- Tool tips: explanatory messages appear when skimming over the toolbar buttons.

## Multi-instance

The multi-instance function enables several applications to be worked on simultaneously.

This function enables:

- Several different applications present on the PC to be opened in offline mode in order to check or copy data.
- Debugging of two (or more) applications on two PLCs present on the same network in on-line mode. This is particularly useful when debugging inter-PLC communication functions.

## Management of access rights

Use of the various PL7 software functions can be limited and controlled by managing the access rights.

There are 5 user profiles (differentiated by passwords) which characterize the functions available to users on the programming terminal. The profiles range from read-only access to an application (lowest profile) to full programming (profile with the most rights).

## Application server

PL7™ Pro software can be launched in OLE Automation server mode from a third-party client application. In this case, certain PL7 program functions can be executed following commands sent by an OLE client application. This instance of the program then no longer reacts to commands from the operator keyboard. Server mode can be launched in offline mode (COM) if both programs are on the same machine, or in remote mode (DCOM), if the programs are installed on different machines.

The commands available are as follows:

- Manage an execution context (open/close an application, modification of the address and driver of the connected PLC; PLC status).
- Control the PLC (connection/disconnection, send a RUN/STOP/INIT command, program uploading/downloading).
- Read data (application or symbol export only in source format, read symbol/comment associated with an address, read application identity).

(1) However, compatibility with the Windows 95 operating system is no longer provided and USB port is not compatible with Windows 95 and Windows NT 4.0.



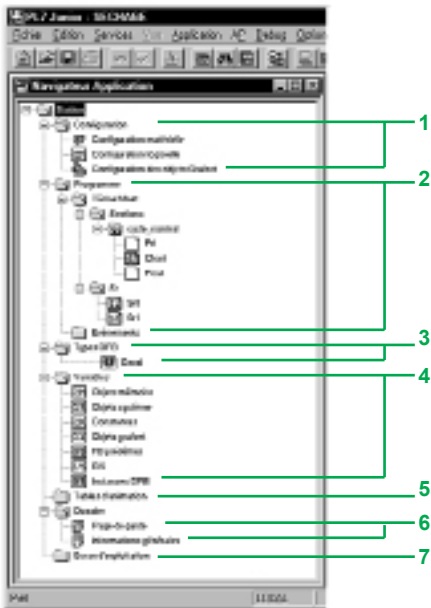

### Application creation and debug tools

#### Application browser (conventional view)

Access to programming and debug tools is gained via the application browser. This gives a global view of the program and enables the application components to be accessed quickly via contextual menus.

- 1 Configuration editor.
- 2 Program editor.
- 3 DFB user function block editor.
- 4 Variable editor.
- 5 Animation table editor.
- 6 Documentation editor.
- 7 Operating screen editor.

#### Concept of sections and Grafcet™ enhancement

In order to make programs more comprehensible, the FAST and MAST tasks are split into sections.

Each section **1** has a name, a comment and is programmed in one of the four languages available in PL7.

A section programmed in Grafcet™ language can contain a main chart **2** and macro-steps **3**. Version ≥ V4.0 of PL7™ allows comments to be added to each macro-step.

To protect intellectual property or avoid any unwarranted modification, each section can be write-protected or read/write-protected.

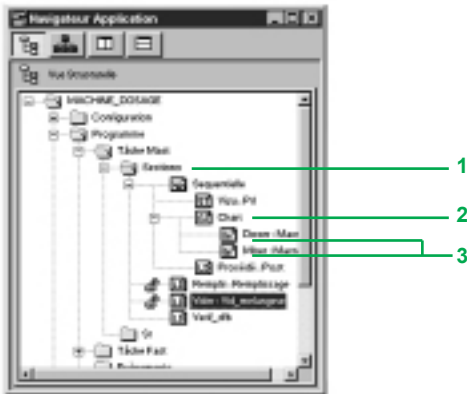

#### Function views of an application

PL7™ Pro software can be used to structure an application for a Premium platform into functional modules that are broken down into sections (program code), animation tables and operating screens. Independently of the multi-task structure of the PLC, the designer can define a multilevel tree structure of the automation application.

At each level, it is possible to attach program sections written in Ladder language (LD), Structured Text (ST), Instruction List (IL), Grafcet (SFC)™, and animation tables.

Two types of view are always available:

- A representation showing a tree structure of modules can provide a breakdown according to consistent functions in relation to the process to control.
- The classic representation of the application browser provides a view of the execution order of the program sections for each PLC.



The operation services associated with the functional view are available in one or the other view. In particular, a single command can be used to force whether or not a functional module is executed.

In this case, every section attached to the functional module is automatically forced.

#### Exporting/importing functional modules

Up to 100% of the tree structure can be exported into functional modules.

In this case, program sections of the different module levels are exported.

During an import, an assistant can be used to reassign the data associated with the module in stages.

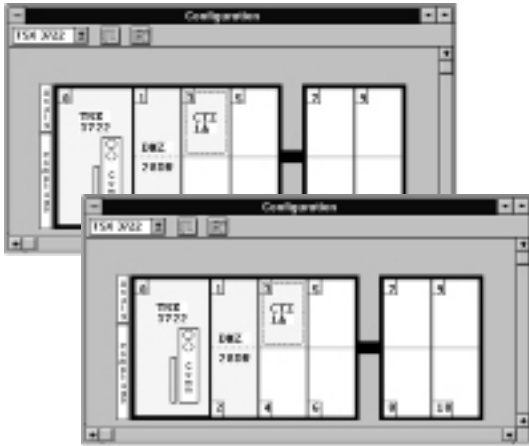

### Configuration editor

#### Hardware configuration

The configuration editor intuitively and graphically enables the declaration and configuration of the various components of the Modicon® Premium™/TSX Micro™ application:

- Processor, coprocessor
- Tasks
- Application-specific I/O modules
- Memory

By clicking on an unconfigured position, the display of a dialog box shows the available I/O modules, classed according to family.

Once the various modules are positioned, selecting them accesses parameter entry for each module.

#### Software configuration

The configuration editor can also be used to set the software parameters of the application: choice of the number of constants, number of internal words and the number of each type of function block.

The configuration editor provides access to parameter entry for the function blocks. The copy/paste function for these parameters is available from version ≥ V4.0 of the PL7™ software onwards.

#### Configuration of Grafcet objects

When programming in Grafcet™ language, the configuration editor can define Grafcet objects (steps, macro-steps, etc.) and execution parameters (number of steps and active transitions).

#### Setup of application-specific functions

A number of tools are provided as standard for setting up the various applications: discrete I/O, analog I/O, counting, motion control (1), man-machine interface (MMI), communication, weighing (1), Warm Standby redundancy (2).

The parameter screens for the application-specific functions are accessed from the I/O configuration screen by clicking on the position in which the module has been defined.

The screens enable the main operating characteristics of the chosen application to be defined, for example:

- Filter values for discrete I/O.
- Voltage or current range for analog I/O.
- Threshold values for counting.
- Path of axes for position control.
- Calibration change during weighing.
- Transmission speed for communication.



(1) PL7 Junior/Pro function available on a Premium platform.

(2) PL7 Junior/Pro function available on a Premium platform based on a TSX P57 353/453M processor (version with integrated Fipio link).

### Software structure

PL7™ Micro/Junior/Pro software offers two types of structure:

- **Single task:** this is the simplified structure offered by default, where a single master task consisting of a main program, comprising several sections and subroutines, is executed.
- **Multi-task:** this structure, which is better suited to high-performance real-time applications, consists of a master task, a fast task and event-triggered tasks, which have the highest priority. Master and fast tasks are divided into sections.

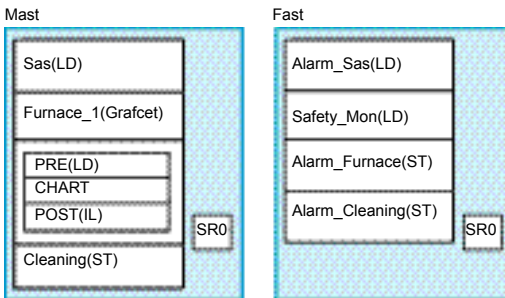

### Structured and modular programming

PL7 program tasks are comprised of several parts called sections and subroutines. Each section can be programmed in the appropriate language for the processing to be carried out.

Such division into sections enables a structured program to be created and program modules can easily be generated or added.

Subroutines can be called from any section of the task to which they belong or from other subroutines in the same task.

### Simple task software structure

There are two types of cyclic execution:

- **Normal cyclic execution.** This is the default option.
- **Periodic execution.** This type of execution, as well as the period, are selected by the user during configuration.

#### Normal execution (cyclic)

At the end of each scan, the PLC system launches the execution of a new scan. The execution time of each scan is monitored by a software watchdog whose value is defined by the user.

In the event of overrun, a detected fault will cause:

- The scan to stop immediately (STOP).
- A display on the front panel of the PLC.
- The alarm relay of the main rack power supply to be set to 0.

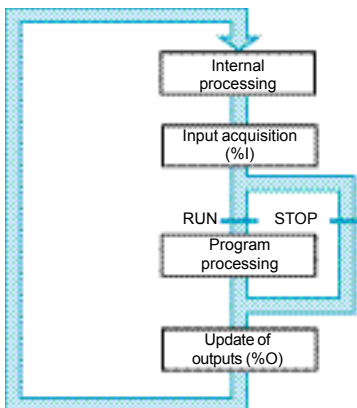

#### Periodic execution

A new scan is executed at the end of each period. The execution time of the scan must be less than the time of the period defined (1 to 255 ms). In the event of overrun, the latter is stored in a system bit (%S19), which can be set to 0 by the user (by program or by the terminal).

A software watchdog which can be configured by the user monitors the scan time. In the event of overrun, a detected execution fault is signaled (see normal execution).

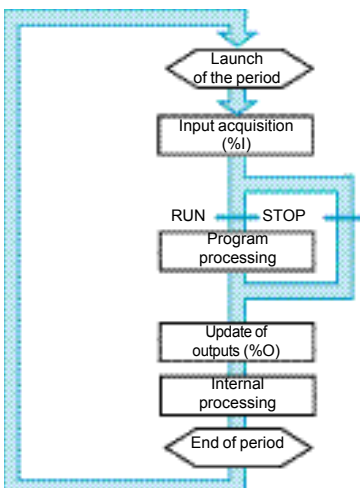

#### Multi-task software structure

PL7™ Micro/Junior/Pro software offers a Multi-task software structure, consisting of:

- A master task (divided into sections, one of which may contain Grafcet™).
- A fast task (divided into sections).
- One or more event-triggered tasks (only one section per task).

These tasks are independent and are executed in “parallel”, with the PLC processor managing the execution priority. When an event occurs, or at the start of the fast task cycle:

- The current execution of lower priority tasks is stopped.
- The event-triggered task or the fast task is executed.
- The interrupted task takes over again when processing of the priority task is completed.

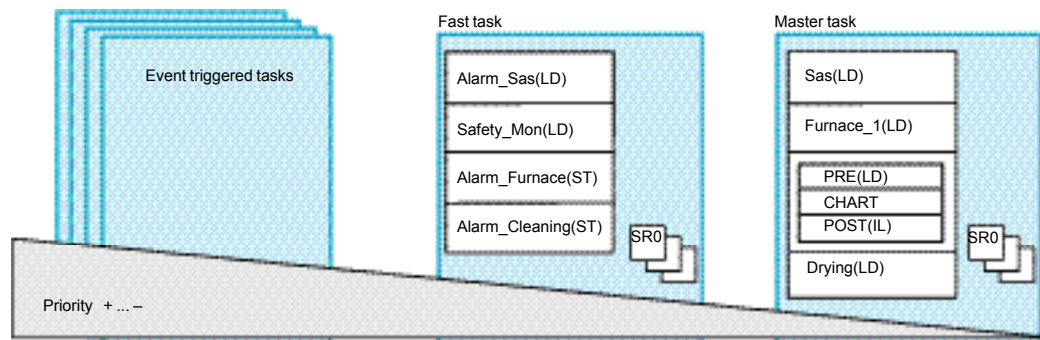

This structure can optimize use of the processing power, and can be used to structure the application and simplify design and debugging, as it is possible to write and debug each task independently of the others.

#### Master task

This compulsory task, which executes the main program, is periodic or cyclic (see single task structures). It is activated systematically. It is intended for sequential processing. Each section can be programmed in Ladder, Structured Text or Instruction List language. One section is dedicated to Grafcet language; when this language is chosen, 3 processing operations are proposed:

- Preliminary processing (PRE) is programmed in Ladder, Structured Text or Instruction List language and processes initializations on power return, operating mode modifications, input logic.
- Sequential processing (CHART) includes the graphic transcription and management of Grafcet charts. It provides access to processing of the actions and transition conditions.
- Post-processing (POST). This is programmed in Ladder, Structured Text or Instruction List language and is used to process the instructions from the 2 preceding processing operations and the indirect safety functions specific to the outputs.

#### Fast task

This task, which is higher priority than the master task, is periodic in order to leave time for execution of the lower priority task. Processing operations in this task must be as short as possible so as not to adversely affect the master task. It is useful when fast periodic changes in discrete inputs need to be monitored.

Each section of this task can be programmed in Ladder, Structured Text or Instruction List language.

#### Event triggered tasks

Unlike the tasks described above, these tasks are not linked to a period. Their execution is triggered by an event occurring in an application-specific module (eg.: overrun of a counter threshold, change in state of a discrete input). These tasks have higher priority than other tasks, and they are therefore suitable for processing operations requiring very short response times to the occurrence of an event. They can be programmed in Ladder, Structured Text or Instruction List language.

#### Number of EVTi control events:

- TSX Micro™ PLCs: 8 events with TSX™ 37 10 and 16 events with TSX 37 21/22.
- Premium™ PLCs: 32 events with TSX™ 57 10 and 64 events with TSX 57 20/30/40 and PCX 57 20/30.

TSX Micro TSX 37 21/22 and Premium PLCs have 2 priority levels (EVT0 event has priority over other EVTi events).

## Ladder language (LD)

### Program structure (section, SR or event-triggered task)

Programs written in Ladder language consist of a series of rungs executed sequentially by the PLC. Each rung may be:

- Identified by a label.
  - Completed by a comment of up to 222 characters.
- A rung consists of 7 lines on TSX Micro™ and 16 lines on Premium™, with 11 columns, allowing a maximum of 10 contacts and one coil per line.

### Program editor: Ladder language

The Ladder language editor offers several tools for constructing rungs in a user-friendly way:

- A palette of graphic elements for direct access to the various graphic symbols of the language via the mouse or the keyboard: contacts, Boolean logic, coils, operation blocks, predefined function blocks...

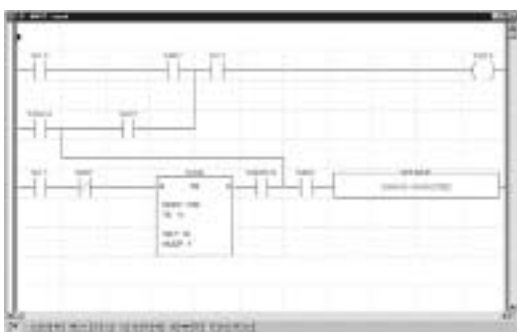

- A rung can be drawn without having to fill in each element.
  - The language objects can be entered and displayed in either symbol or address format.
  - The symbol and address of each object can be displayed simultaneously.
  - A rung is constructed simply by selecting the symbol from the graphic palette and placing it in the correct position in the grid on-screen.
  - An automatic link line function optimizes the number of user actions.
- The Ladder language editor is used to call up the functions which assist data entry:
- Access to function libraries.
  - Access to the variables editor.
  - Cut, copy, paste.

## Structured Text language (ST)

Structured Text language is a sophisticated algorithmic type language which is particularly suitable for programming complex arithmetic functions, table operations, message handling, etc.

### Program structure (section, SR or event-triggered task)

Structured Text language enables direct transcription of a flowchart analysis and is organized into statements. Each statement consists of a label (1000 labels max), comments (256 characters max) and instructions.

There are four methods for controlling statements:

- Conditional action IF.
- Conditional iterative action WHILE (action repeated while a condition is true).
- Conditional iterative action REPEAT (action repeated until a condition is true).
- Repetitive action FOR (action repeated a certain number of times).

### Program editor: Structured Text language

The editor enables statements to be entered one after another.

The editor provides help with entering:

- Modifications, insertion, etc.
- Cut, copy, paste.

Objects can be entered and displayed in either symbol or address format.

Different colors are used for the objects, language key words and program comments to make it easier to read.



# Modicon® Premium™ automation platform

## PL7™ software

Grafcet™ language (SFC)™ and Instruction List language (IL)

Premium™ PLC	TSX Micro™ PLC
<ul style="list-style-type: none"> <li>■ maximum of 250 steps (2) on 8 pages</li> <li>■ 64 macro-steps of 250 steps.</li> <li>■ A "generic" comment can be associated with each macro-step</li> <li>■ 1024 transitions maximum (2)</li> <li>■ 11 elements maximum per divergence/convergence</li> <li>■ 1024 steps maximum in the application</li> </ul>	<ul style="list-style-type: none"> <li>■ 96 steps maximum (2) on 8 pages for TSX 37-10 and 128 steps for TSX 37-21/22</li> <li>■ 1024 transitions maximum (2)</li> <li>■ 11 elements maximum per divergence/convergence</li> </ul>

### Grafcet™ language (SFC)™

Grafcet language is used to describe, in a simple and graphic manner, the sequential part of control systems. It corresponds to the SFC "sequential function chart" language described in standard IEC 61131-3.

#### Structure of the section in the master task

Grafcet™ SFC™ language is only used in one section of the master task. This is structured in three processing operations, see page 6/13 of this catalog. Programs written in Grafcet SFC language consist of:

- Macro-steps (1) which are the only representation of a set of steps and a transition.
  - Steps, with which the actions to be executed are associated.
  - Transitions, with which the conditions are associated (transition conditions).
  - Directed links, connecting the steps and transitions.
- The actions (continual, pulsed on activation or deactivation) and transition conditions can be programmed in the desired language: Ladder, Structured Text or Instruction List.

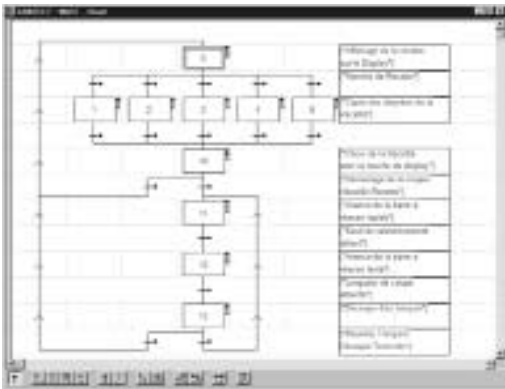

#### Program editor: Grafcet SFC language

The editor offers 8 pages, each consisting of 11 columns and 14 lines, giving 154 cells per page.

A palette of graphic objects is used for direct access to each graphic symbol (macro-steps, steps, transitions, sequence selection, simultaneous activation/deactivation and connectors).

Programming of the transition conditions and actions is performed simply by clicking on the required chart element.

On a Grafcet page, comments of up to 64 characters can be entered in any cell. Functions which assist entry: cut, copy, paste, etc. are available to the user.

### Instruction List language (IL)

Instruction List language is a language representing, in the form of text, the equivalent of a Ladder diagram. It is used for writing Boolean equations and making use of the functions available in the language.

#### Program structure (section, SR or event-triggered tasks)

A program in Instruction List language is comprised of a sequence of instructions from the following different families:

- Bit instructions, for example read input n° 3: LD %I1.3.
  - Instructions on function blocks, for example start timer n° 0: IN %TMO.
  - Numerical instructions on single, double and floating point integers, for example, perform an addition: [%MW10:= %MW50 + 100].
  - Instructions on word tables, character strings, for example, perform an assignment: [%MW10:10:=%KW50:10].
  - Program instructions, for example, call subroutine n° 10: SR10.
- Each instruction is composed of an instruction code and a bit or word type operand.

#### Program editor: Instruction List language

As in Ladder language, instructions are organized into sequences of instructions (equivalent to a rung). Each sequence of instructions can be identified by a label %Li, with i being from 0 to 999 and accompanied by a comment of 222 characters maximum.

Each sequence of instructions is composed of one or more test instructions. The result of these instructions is applied to one or more action instructions.

Objects can be entered and displayed in either symbol or address format. The editor provides help with entering data.



(1) With Premium PLCs only.



## Functions

### User DFB function blocks

Utilizing PL7™ software - running on Modicon® Premium™ PLCs - the user can create their own function blocks which meet the particular needs of their applications. Once they have been created and saved to the library, these function blocks can be used repeatedly with PL7™ Junior/Pro software.

These user function blocks enable an application to be structured. They are used as soon as a program sequence is repeated several times in the application or to freeze a standard type of programming. They can be exported to all other PL7 applications. Using a DFB function block in one or more applications enables:

- Simplification of program entry and design.
- Improved program readability.
- Easier debugging (variables handled by the DFB function block are identified on its interface).
- Use of DFB-specific internal variables (independent of the application).

A DFB derived function block is set up in three phases:

- Design of the DFB which has a name, parameters (I/O), variables and code in Structured Text or ladder language.
- Creation of a DFB instance in the variables editor or when calling the function in the program editor.
- Using this instance in the program in the same way as a standard function block.

### Main characteristics

<b>Inputs</b>	16 max. (1)
<b>Outputs</b>	16 max. (2)
<b>Inputs/outputs</b>	16 max. (1) (2)
<b>Public internal variables</b>	1000 (can be accessed via the application program)
<b>Private internal variables</b>	1000 (cannot be accessed via the application program)
<b>Comment</b>	322 characters max.
<b>Program sections</b>	One section in one of the 2 languages (ST, LD).

(1) The maximum cumulative total of inputs and inputs/outputs is 16.

(2) The maximum cumulative total of outputs and inputs/outputs is 16.



### Variables editor

The variables editor is used to:

- Symbolize the various application objects (bits, words, function blocks, I/O, ...).
- Define the parameters of the predefined function blocks (timers, counters, registers etc.).
- Enter the values of the constants and select the display base (decimal, binary, hexadecimal, floating point, message).
- Define the DFB user function block parameters.

Each symbol (32 characters max, accented characters are permitted) can be accompanied by a comment (508 characters max).

Editing services are available in the editor:

- Find/replace an object in a part of the program or in a set of function modules (PL7 Pro).
- Find a character string in a list of symbols or comments.

Version ≥ V4.0 of PL7 offers enhanced functions due to:

- Copy/paste function for one or more symbol(s) and comments.
- Display in plain language of the overlap of different types of variable on a single memory address (for example, single and double format internal words, %MW0/%MD0).
- Highlighting of objects used by the application program.
- Opening the application variable database to third-party tools by importing/exporting text files (.txt). This new function makes it possible to create/modify application databases using a third-party software (for example TSX Microsoft Excel) that has extended edit functions.

For each numerical variable, it is possible to select the display base (decimal, binary, hexadecimal, floating point, ASCII message).

Version ≥ V4.0 of PL7 offers new options for animation tables:

- Display of the comment associated with variables.
- Assignment of a single value to a number of variables.
- Change of display format for a number of variables.
- Display of the list of forced bits.



## Functions (continued)

### Animation table

Tables containing the application variables to be monitored or modified can be created by entering them or automatically initialized from the selected phrase or rung.

Variables can then be:

- Modified.
  - Forced to 0 or 1 for bit objects.
- For each numerical variable, it is possible to select the display base (decimal, binary, hexadecimal, floating point, ASCII message).

Version ≥ V4.0 of PL7™ offers new options for animation tables:

- Display of the comment associated with variables.
- Assignment of a single value to a number of variables.
- Change of display format for a number of variables.
- Display of the list of forced bits.



### Documentation editor

The documentation editor is built around the Documentation Browser which displays the contents of the documentation file in a tree structure.

It can be used to print up to 100% of the application documentation file on any graphic printer which can be accessed in Windows and uses True Type technology, in A4 or US letter print formats.

The documentation editor is used to define:

- A title page, including the name of the designer and project.
- General information pages.
- A footer.

The documentation editor automatically generates:

- The contents.
- The application documentation file: hardware and software configuration, program with its comments (including those relating to the macro-steps and subroutines).
- The list of variables sorted by address or symbol.
- The cross-references, sorted by address or symbol.

6

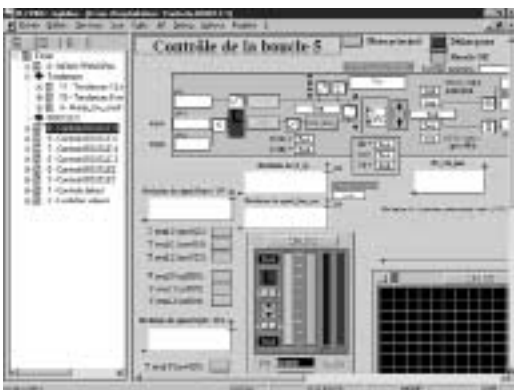

### Runtime screens

The runtime screen tool is integrated in PL7™ Pro software (creation and use of screens). It is intended in particular, for debugging when starting up installations and for diagnostics on detected faults or malfunctions.

It is comprised of data (explanatory texts, dynamic values, synoptics, etc.) and enables a simple and fast action (modification and dynamic monitoring of PLC variables).

The editor enables the design of these screens using the following tools:

- Screen: creation of runtime screens, which can be classed according to family.
- Message: creation of messages used.
- Objects: creation of a graphic objects library.

When the station is connected to the PLC, the user can display screens dynamically depending on the state of the process.

Screen sequencing is possible, depending on the attributed priority, via either the keyboard or PLC request.

In online mode, runtime screens enable direct access to the PL7 program from synoptics by simply clicking on the selected object.

It is also possible to activate the animation table functions or cross references once one or more variables have been selected on the screen. Version ≥ V4.0 of PL7 software also enables character string type objects to be displayed.

Synoptics can be displayed on the full screen for ease of viewing.

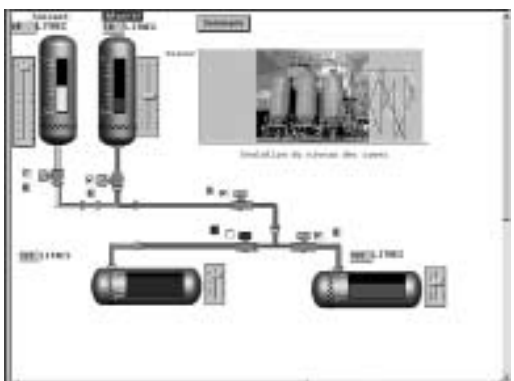



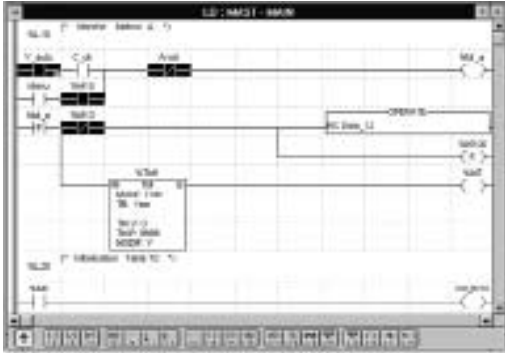

#### Debugging tools

PL7™ Micro/Junior/Pro software offers a complete set of tools for debugging applications. A tool palette provides direct access to the main functions:

- Setting stop points.
- Step by step program execution.
- Independent execution of the master (MAST), fast (FAST) and event-triggered (EVTI) tasks.



#### Animation of program elements

Parts of the program are animated directly when the Modicon® Premium™/TSX Micro™ PLC is in the RUN rung, (Structured Text statement or sequence of instructions in Instruction List language) by activating the PL7 animation function. Animation is used to display the status of program variables, whatever the language used.

The animation can be frozen. Several windows can be displayed and animated simultaneously.



#### Animation tables

Tables containing the application variables to be monitored or modified can be created by entering them or automatically initialized from the selected program part. Variables can then be modified, forced to 0 or to 1 for bit objects.

These tables can be stored in the application and therefore retrieved at a later date.

#### Debugging the DFBs

■ Animation table: public parameters and variables are displayed and animated in real time. It is possible to modify and force the desired objects.

■ As for the rest of the program, it is possible to use the following functions: breakpoint, step-by-step and program diagnostics.

#### Grafcet™ debugging

In online mode, the browser gives a hierarchical view of the chart with CHART module and macro-step nesting. Animation is characterized by the presence or absence of indicator colors.

The Grafcet debug bar:

- Displays the state of the chart.
- Modifies the state of the chart.
- Gives information on the state of the Master task.

#### Debugging the application-specific functions

The debug screens for the application-specific functions are accessed from the I/O configuration screen by clicking on the position in which the module has been defined, when the terminal is in online mode.

These screens are used for:

- Displaying and modifying the state of the I/O.
- Forcing the I/O.
- Displaying and modifying the current values.

#### Diagnostics

The debug screens provide access to the general module or channel diagnostics.

These screens identify:

Detected internal module faults.

- Detected external faults from the application.
- E.g.: range detected overrun fault for an analog module.

With version ≥ V4.0 of PL7™ software, the Modicon® Premium™ platform system diagnostics are extended. It is possible to monitor system bits and words as well as to display associated time-stamped messages automatically, without the need for additional programming. This monitoring applies to the system elements (processor, memory, tasks), in-rack I/O and remote I/O on the Fipio® bus.



## Presentation

### Integrated diagnostics in Modicon® Premium™ automation platforms

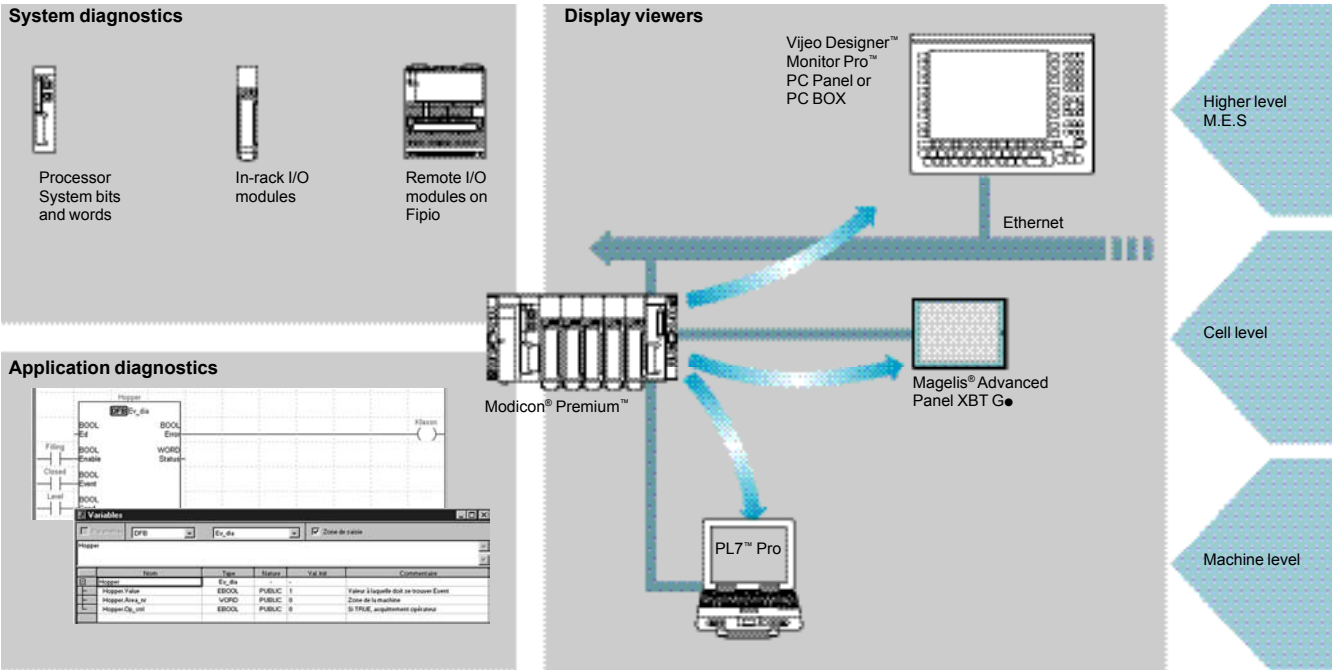

The diagnostic offer of Premium platform is built on three elements:

- System diagnostic.
- Diagnostic DFBs function blocks (system and application).
- Error message display system or viewers supplied as standard with Magelis® XBT G● and Magelis® iPC PC Panel/PC BOX, Vijeo Designer™, Monitor Pro™ supervisory and PL7™ Pro™ setup software

# 6

## Functions

### System diagnostics

With version V4 of PL7 software, the Premium platform system diagnostics has been enhanced by the monitoring of system bits/words and I/O (in-rack and remote via the Fipio® bus). Events automatically display time and date-stamped messages, without any additional programming, using one of the display units (1).

The diagnostic functions integrated in PL7 Junior/Pro software can be used for 1st level diagnostics of the configuration elements, and are effective for every module up to channel level.

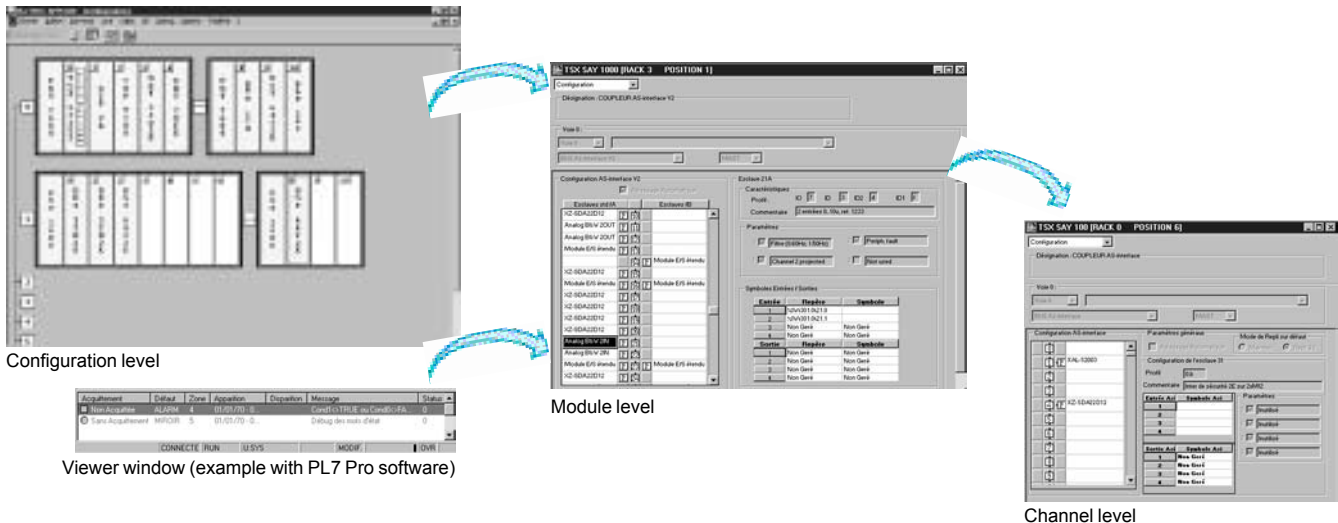

(1) Diagnostic viewers are tools used to display and acknowledge detected error messages relating to diagnostics. They are supplied as standard with PL7 Pro, Vijeo Designer and Monitor Pro software, with Magelis terminals, and with the PLC web server which is accessible through a thin client Magelis PC Panel or PC BOX.

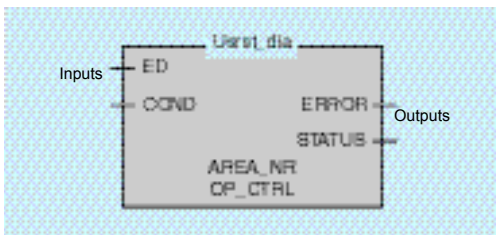
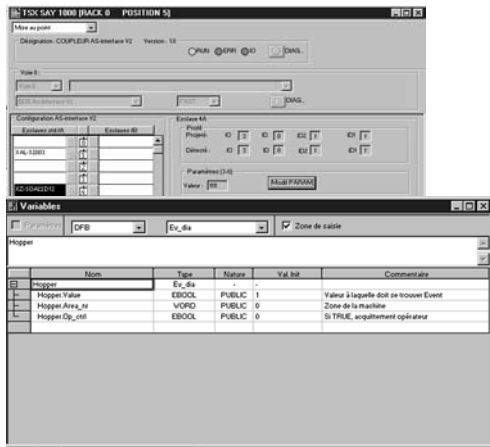

## Functions (continued)

### Application diagnostics

PL7™ Pro software has an integrated function block library containing monitoring function blocks known as Diagnostic DFBs. The Diagnostic DFB library is comprised of:

System diagnostic manufacturer blocks:

- IO\_DIA detected input/output fault. It can be used to monitor the state of the inputs/outputs.
- ASI\_DIA checks for the appearance of any detected errors on the AS-Interface® bus (module or detected bus fault, slave missing, slave not configured or detected errors).

Application diagnostic manufacturer blocks:

- EV\_DIA checks that an event (state of a bit) takes the correct value at the expected time (no notion of time).
- MV\_DIA checks the requested movement (change in the state of a bit) due to occur in a preset time period.
- ALRM\_DIA monitors the state of a bit (at 1 or 0).
- NEPO\_DIA and TEPO\_DIA can be used to monitor, control and diagnose the elements of the operating part created by wiring 2 preactuators and 2 sensors in conjunction.

Open diagnostic blocks:

These offer users the option of creating their own diagnostic function blocks to meet the specific requirements of their applications, thus complementing the manufacturer DFBs described above. They are created using 2 model blocks written in Ladder or Structured Text language.

The following can be created simultaneously in one application:

- a maximum of 26 types of system diagnostic DFBs
- a maximum of 26 types of application diagnostic DFBs.

### Viewers

The diagnostic events processed by the Modicon® Premium™ PLC using the diagnostic DFBs are stored in a buffer (memory space for data specific to the Premium PLC). The information contained in this PLC buffer is sent transparently for the user to the viewers and can be displayed automatically and used to handle errors and alarms. The viewer function is included as standard in:

- PL7™ Pro programming software
- CCX 17 version > V 2.5 operator panels
- Magelis® XBT-F graphic terminals
- Monitor Pro™ supervisor version V7.0.

The Premium platform has a multi-viewer option (link to a maximum of 15 viewers). A PC compatible station with the viewer function can be connected to several PLCs (link via X-Way™ communication to a maximum of 15 Premium platforms).

This buffer/viewer structure offers:

- A single point for managing detected faults per application
- Time and date-stamping at source of the appearance of detected faults
- Memorization of detected transient faults
- Independence from the viewer functions. The frame transmitted from the PLC buffer is identical for each viewer.

Composition of messages:

Each line displayed by the viewer represents a detected fault with, depending on the display capacity: state, type of DFB, geographical zone, dates and times of appearance/disappearance, associated message and status.

- 1 Viewer window on PL7™ Pro screen.

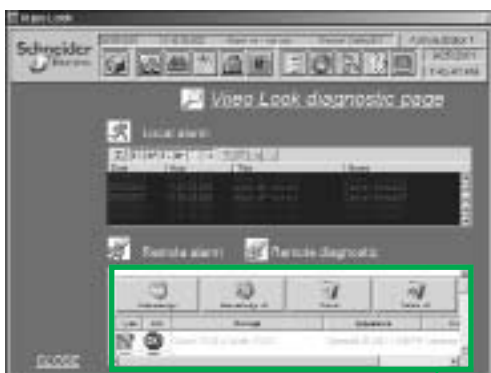

1

# Modicon® Premium™ automation platform PL7™ software

## Variable cross-references and Application converters



### Variable cross-references

For every variable, this function can be used to:

- Search for program modules where this variable is used.
- Obtain the list of statements, rungs or expressions.
- Display and check activation conditions.

A log is used to keep track of this navigation.

Options relating to the variable, can be associated with the search (extract bit, table object, function block elements, network object, etc.).

This function can be initialized from the program or runtime screens.

### Application converters

PL7™ Micro/Junior/Pro software includes application converters which make it possible to reuse in full or in part, applications already written in:

- PL7 2, applications for TSX™ 17, TSX 27 or TSX 47 10/20/25 PLCs.
- PL7 3 (1), applications for TSX™/PMX 47...TSX/PMX 107 PLCs.
- ORPHEE (1), applications for April Series 1000 PLCs.

The converters offer the following utilities:

- Translation of language objects into the new PL7 syntax with retrieval of associated symbols and comments.
- Possibility of manually reassigning objects.
- Configuration check: the tool checks whether the configuration resources required by the program to be converted are compatible with the configuration of the destination application.
- Conversion (1) with generation of source files (Ladder, Structured Text or Grafset™) in PL7 Junior/Pro format.
- Conversion helps to ensure that instructions which are translated are functionally identical to the original program.
- A translation report gives a summary:
  - result of the conversion with the cause of non-translation where possible,
  - correspondence of variables in PL7 with original variables.

(1) Function or functionality requiring PL7 Junior/Pro software.

## X-Way™ communication drivers

The communication drivers (Uni-Telway™ COM port and USB port, PC side) are available in the PL7™ software CD-ROM.

Depending on needs, another drivers can be installed from TLX CD DRV20M CD-ROM (to order separately). See following table.

Type of drivers	Windows XP Windows 2000	Windows NT	Windows 98 Millenium	Windows 95
Uni-Telway™ COM port	V1.8 IE19	V1.9 IE17	V1.7 IE18	V7.8 IE18
Uni-Telway™ TSX SCP 114	V1.1 IE04			
Modbus® COM port	V1.5 IE25			
Fip® ISA TSX FPC10 card	V1.4 IE06	V1.3 IE08	V1.4 IE06	V2.4 IE08
Fip® TSX FPP 20 PCMCIA card	V1.2 IE03	V1.1 IE08	V1.2 IE04	
Ethway™	V1.4 IE02	V1.1 IE03	V2.6 IE06	
ISAWay™ PCX 57, ISA card	V1.2 IE04	V1.5 IE06	V1.2 IE04	V1.2 IE09
PClway™, PCI card	V1.1 IE09	-		
XIP X-Way™ on TCP/IP	V1.9 IE20			
USB for mini-DIN terminal port	PL7 included	-		
USB for USB terminal port	V1.0 IE14	-		



## References

Multilingual software packages (English, French, German, Spanish and Italian) for PC compatibles (1) equipped with Windows 98®, Windows NT 4.0®, Windows Millennium®, Windows 2000 Professional® or Windows XP® operating systems.

■ **For one station**, these packages are comprised of:

- A CD-ROM supporting the PL7™ multilingual software, the PL7 demonstration applications and the terminal link Uni-Telway™ driver,
- Two CD-ROMs containing multilingual technical documentation,
- A CD-ROM containing the TSX Micro™/Premium™ platform operating systems.

■ **For packages for 3 stations**, the above quantities are multiplied by three. the cordsets must be ordered separately, according to the required number of users.

The cordsets must be ordered separately, according to the required number of users and the type of connection (USB port or RS 232). See Separate elements page 6/77.

(1) Typical recommended configuration: Pentium processor, 266 MHz, 128 Mb of RAM memory, CD-ROM drive for installation of the PL7 program, VGA screen or above.

# Modicon® Premium™ automation platform

## PL7™ software

### Software packages



#### PL7™ Micro software packages

PL7™ Micro software enables programming in Instruction List, Ladder, Structured Text and Grafset™ language. It can also be used to set up application-specific functions and perform maintenance and diagnostics of the developed applications. It includes the PL7 2 application converter.

Description	For PLC	Type of device and update	Reference	Weight kg
<b>PL7™ Micro software packages</b>	TSX Micro™	Single (1 station)	<b>TLX CD PL7M P45</b>	–
		Group (3 stations)	<b>TLX CD3 PL7M P45</b>	–
<b>PL7 Micro and SyCon® V2.8 software package</b>	TSX Micro	Single (1 station)	<b>TLX CD PL7M PC45</b>	–
<b>Software updates for previous version of PL7 Micro</b>	TSX Micro	Single (1 station)	<b>TLX RCD PL7M P45</b>	–
		Group (3 stations)	<b>TLX RCD3 PL7M P45</b>	–
Software update for previous version of PL7 Micro supplied with SyCon V2.8	TSX Micro	Single (1 station)	<b>TLX RCD PL7M PC45M</b>	–

#### PL7™ Junior software packages

PL7™ Junior software enables programming in Instruction List, Ladder, Structured Text and Grafset™ languages. It can also be used to set up application-specific functions and perform maintenance and diagnostics of the developed applications. It includes the PL7 2, PL7 3 and ORPHEE application converters.

Description	For PLCs	Type	Reference	Weight kg
<b>PL7™ Junior software packages</b>	TSX Micro™, Premium™	Single (1 station)	<b>TLX CD PL7J P45</b>	–
		Group (3 stations)	<b>TLX CD3 PL7J P45</b>	–
<b>Software updates for previous version of PL7 Junior</b>	TSX Micro, Premium,	Single (1 station)	<b>TLX RCD PL7J P45M</b>	–
		Group (3 stations)	<b>TLX RCD3 PL7J P45M</b>	–
<b>Software upgrade packages from previous version of PL7 Micro</b>	TSX Micro, Premium,	Single (1 station)	<b>TLX UCD PL7J P45M</b>	–
		Group (3 stations)	<b>TLX UCD3 PL7J P45M</b>	–

# Modicon® Premium™ automation platform

## PL7™ software

### Software packages



#### PL7™ Pro software packages

Functions on PL7™ Pro software are identical to those on PL7™ Junior software. It also offers the user the possibility of creating his own function blocks (DFBs) and graphic runtime screens.

Description	For PLCs	Type	Reference	Weight kg
PL7™ Pro software package	TSX Micro™, Premium™	Single (1 station)	TLX CD PL7P P45	–
		Group (3 stations)	TLX CD3 PL7P P45	–
Software updates for previous version of PL7 Pro	TSX Micro, Premium	Single (1 station)	TLX RCD PL7P P45M	–
		Group (3 stations)	TLX RCD3 PL7P P45M	–
Software upgrade packages from previous versions of PL7 Junior	TSX Micro, Premium	Single (1 station)	TLX UCD PL7P P45M	–
		Group (3 stations)	TLX UCD3 PL7P P45M	–

#### PL7™ Micro/Pro software packages

Description	For PLCs	Type	Reference	Weight kg
PL7™ TSX Micro™ Open Team software license	TSX Micro	Team (10 stations) (1)	TLX OT PL7M P45M	–
PL7™ Pro Open Team software license	TSX Micro, Premium	Team (10 stations) (1)	TLX OT PL7P P45M	–
PL7 Pro Open Site software license	TSX Micro, Premium	Site > 10 stations (1)	TLX OS PL7P P45M	–

#### Accessories

Description	Use	Reference	Weight kg
X-Way™ drivers package for compatible PC	Includes X-Way drivers (see page 6/75) Includes multilingual user documentation.	TLX CD DRV20M	–



TSX PCX 1031



TSX CUSB 485

Description	Used from processor	to PC port	Length	Reference	Weight kg
Universal terminal port cable	Mini-DIN port TSX Micro/Premium	RS 232D (15-way SUB-D connector)	2.5 m	TSX PCX 1031	0.170
		USB port (USB/RS 485 converter)	0.4 m	TSX CUSB 485 (2)	0.144
		USB Port (mini-DIN/RJ45 cordset)	2.5 m	TSX CRJMD 25 (2)	0.150

(1) Team user stations from the same geographical site.

(2) With TSX CUSB 485 converter, use the TSX CRJMD 25 cordset (equipped with 1 x mini-DIN and 1 x RJ45 connectors).

**Presentation**

C language function development software, also called SDKC, is a PL7™ Micro, PL7™ Junior and PL7™ Pro software option. It enables new functions to be developed (internal code written in C language) and extends and completes the standard set of functions offered by PL7 software.

SDKC software also integrates a creation and management service for families of functions, so they can be integrated in the PL7 library.

Finally, it can be used to generate the function which helps to ensure the protection of PL7 applications by reading a signature in the PCMCIA card inserted in the PLC.

**Setup**

C language development software is a genuine tool for managing the entire function which has been created:

- A user-friendly creation interface, integrated in PL7, with automatic file organisation.
- Powerful debug and test tools.
- Management of compatibility and software version for the functions created.
- Generation of disks for the subsequent installation of functions on other development stations.

**Management of function families**

The software enables different function families to be defined. These functions, also known as EF, are classed according to family, allowing the user to create a sequential library of functions written in C language.

These functions, which will eventually form a part of the PL7 library, can be:

- Used in each language.
- Displayed by the PL7 library tool.
- Classed according to family/function.

The user has the following data at his disposal:

- Date of creation and generation of the function.
- The version number of the function family.



**Editing functions**

The various SDKC software editor tabs enable the user to create the function by:

- Declaring the interface (name, type and comment) for each input, output or I/O parameter.
- Writing the source code file in C language.
- Declaring the constants as separate files.

A function written in C language can access numerous internal PLC services such as real-time clock, PLC variables, system words, mathematical functions. In particular, it is possible to carry out numerical processing in floating point format, if the target PLC allows.



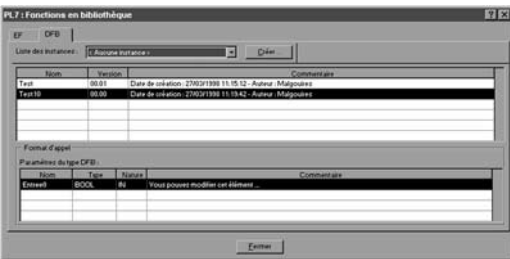

### Setup (continued)

#### Debugging the functions

The function created must be generated under the “debug” format to be tested. Once it has been inserted in an application and loaded to a PLC, the execution of a function can be checked using numerous debug tools.

A specific function debug menu in C language accesses the following services:

- Breakpoint insertion.
- Step by step execution.
- Display of code with breakpoints shown.
- Display of data manipulations.

#### Functions library enhancement

After developing, generating, then debugging the function, the last step consists of generating a function family installation disk.

This enables the function library on the user's programming terminal to be enhanced. Managing the versions allows the level of any functions installed on a station to be known at any time.

These functions can be used in each PL7™ language.

### Reference

This software extension enables standard functions offered by PL7™ Micro, PL7™ Junior and PL7™ Pro version > V4 software to be extended.

This software is supplied with a Microsoft Visual C++ software package registration card.

#### PL7™ SDKC procedure creation software

Description	Function	Target PLC extension	Reference	Weight kg
PL7 SDKC software extension	Procedure written in C language with access to floating point functions Debug in PLC	PL7™ Micro/Junior/Pro TSX Micro™/Premium™	TLX L SDKC PL7 41M	0.230

## Presentation

PL7™ FUZ software is a PL7™ TSX Micro/Junior/Pro software option enabling fuzzy logic processing in order to optimize the control of processes from TSX Micro™ and Premium™ PLCs. This is a software function which can be integrated in any PL7 program. It includes setup and debug tools.

This function is particularly suitable for controlling:

- Systems which are difficult to model or non-linear systems, with wide variation of inputs or an insufficient sensor resolution.
- Systems which are difficult to control and require experience and human intuition.

It enables:

- Boolean logic limits to be exceeded (true or false state).
- The representation of physical measurements by gradual concepts.
- Benefit to be gained from the expertise of operators when controlling a process.

The fuzzy logic function is characterized by:

- 5 physical measurements used as inputs (temperature, pressure, speed...).
- 20 graphic related functions which allow the physical measurement inputs to be represented by predefined associated linguistic terms. A temperature will be represented for example by the terms: low, average, high according to the limits for the various terminals.
- 25 linguistic rules which determine the state to be applied to the outputs (3 conditions and 2 conclusions per rule).
- 4 numerical variables as outputs, results applying to the function input values
- The possibility of debugging its control offline.

Once inserted in a program, the fuzzy function can either operate in continuous mode (function executed on each scan) or on request (a single iteration on each execution). The operating mode enables the function to be used in automatic mode (calculation of the outputs depending on the state of the inputs) or in manual mode (applications with predefined output values).



## Software setup

The fuzzy logic function software is set up in 2 steps:

- Integration of the fuzzy function in the application program, in the same way as any other standard function.
- Setting the fuzzy function parameters using the setup screen.

## Integration in the program

The fuzzy logic function is inserted in the program in each of the available languages. The software checks the various function parameters:

- The 5 input variables.
- The 4 output variables (plus an error bit).
- The internal variables necessary for the function to operate correctly.

The function setup screen is used to access parameters (I/O), membership functions, linguistic rules, as well as debug functions.

## Membership functions

The membership functions are described intuitively using a suitable layout. A membership function is characterized by:

- The selection of one of the parameters (I/O).
- The choice of associated linguistic terms from a library of terms predefined or created by the user.
- The type of function to apply for the inputs (trapeze, triangle, etc) as well as its characteristic values and the functions to apply for the outputs (singleton).

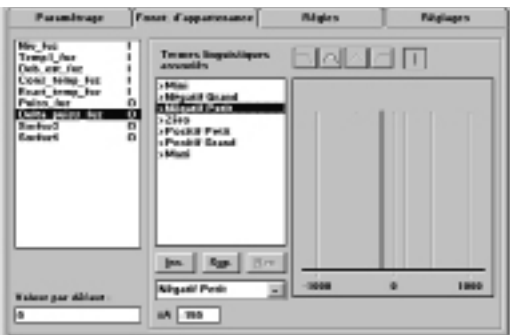



## Software setup (continued)

### Linguistic rules

Linguistic rules (25 maximum) enable experts' know-how to be transcribed using conditions/conclusions such as: If... Then...

- The definition of a rule is made easier by selecting the input parameters (3 per rule).
- By assigning one of the possible linguistic terms to each input.
- By defining the outputs affected by this rule (2 per rule) as well as the associated linguistic terms.

### Simulation and debug

The fuzzy function is easily debugged using the setup and debug screen, especially simplified by the possibility of simulating the operation offline.

#### Offline simulation

Once the parameter entry screens have been completed, it is possible to perform the fuzzy function operation offline. The debug screen offers the possibility of:

- Forcing values for the various input variables.
- Starting the simulation using the "Start" key.

The results achieved are:

The values which will be applied to the outputs in normal operation.  
The percentages obtained under the various rules.

#### Debug in online mode

In online mode the debug screen enables:

- Display of the state of the I/O.
- Access to the involvement percentages obtained under the various rules.

It can also:

- Force the inputs for testing precise operating points.
- Change to manual mode to apply predetermined values on the outputs.
- Change the operating mode: on request, or continuously by defining a period of activation.



## Reference

This software extension enables standard functions offered by PL7™ Micro, PL7™ Junior and PL7™ Pro software to be extended into the domain of fuzzy logic.

### Software for fuzzy logic processing

Description	Function	Target PLC extension	Reference	Weight kg
PL7™ FUZ software extension	Development and debugging of fuzzy logic applications. Defines the membership functions and fuzzy rules for the applications.	PL7™ Micro/Junior/Pro TSX Micro™/Premium™	TLX L PL7 FUZ 34M	0.230

## Presentation

PL7™ DIF application comparison software for Modicon® Premium™ platforms is an optional program which complements the PL7™ Pro programming software. It is used to compare two PL7 applications generated by PL7 Pro and automatically provide an exhaustive list of the differences between them.

The PL7 DIF program increases productivity in the main life phases of a control system based on a Premium platform:

- Application development and debugging.
- Starting up installations and processes.
- Operation and maintenance of installations and processes.

PL7 DIF software is an efficient tool for handling PL7 applications for:

- Control system design offices.
- Operation and maintenance managers.
- Installers and systems integrators.

## Software setup

The PL7™ DIF software can be used in one of two modes:

- Interactive mode, when the comparison is launched by an operator command (double-click on the PL7™ DIF software icon).
- "Batch" mode, when it is launched by a previously established call command.

These comparison commands locate the differences between two applications in terms of:

- The hardware configuration.
- The application access protection.
- The software structure with the section validation conditions.
- The application program regardless of the language(s) used.
- The function modules.
- The code for the DFB user function blocks.
- The variables.

The result of the comparison between the two applications can be:

- Displayed.
- Printed.
- Saved in .txt format in a differences list.

## Comparison

The end of the comparison operation is signalled by the appearance of the application browser with its three tabs.

- 1 Identification tab for accessing the characteristics of the two applications being compared. The differences are marked by the sign #.
- 2 Browser tab for accessing the application multilevel tree structure.
- 3 List tab for accessing:
  - Printing the comparison list,
  - Creating the comparison file.

6



1



2



3

## Setup (continued)

### Display of results

The representation of the application multilevel tree structure, which can be accessed via the browser tab after launching a comparison, is annotated by 4 symbols in which the information associated with application 1 appear in blue and those associated with application 2 appear in red:



This branch, found in this level of the tree structure, contains at least one difference



This block contains at least one difference



This section is only present in application 1



This section is only present in application 2



The programming language of this section differs between application 1 and application 2

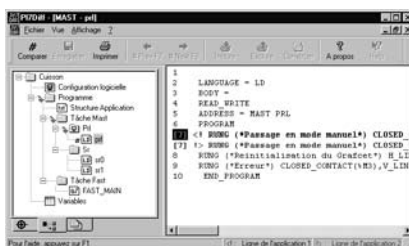

In the example opposite, a difference on the rung causing changeover to manual mode is detected:

- 1 This line [7] displayed in blue belongs to application 1.
- 2 This line [7] displayed in red belongs to application 2.

The source code extracts of both applications can be used to locate the differences precisely.

### Printing a comparison list/creating a comparison file

The list tab is the means of accessing the functions for printing a comparison list or creating a comparison file:



Access to the list form for printing a comparison list (or creating a comparison file)



Include

Used to include the block selected in the tree structure in the comparison list (or the comparison file)



Exclude

Used to exclude the block selected in the tree structure of the comparison list (or the comparison file)



Constituer

Used to create the comparison list (or the comparison file) according to the selections above



Imprimer



Enregistrer

Starts printing the comparison list (or saving the comparison file)

## References

This software extension can be used to compare two PL7™ applications generated by PL7™ Pro and designed for Premium™/TSX Micro™ platforms. It is comprised of one CD-ROM (three disks), containing the PL7™ DIF software with its documentation (English and French). A software subscription is available for this extension (please consult your Regional Sales Office).

### PL7™ DIF application comparison software

Function	Target extension PLC target	Type of device	Reference	Weight kg
Using for comparing applications generated by PL7™ Pro version ≥ V4	PL7™ Pro	1 station	<b>TLX CD PL7 DIF 42</b>	–
	TSX Micro™/ Premium™	Open Site (> 10 stations)	<b>TLX OS PL7 DIF 42</b>	–

# Modicon® Premium™ automation platform

## PL7™ software

### Process control

The process control range integrated as standard in Modicon® Premium™ platforms enables the setup and debugging of process control loops specifically designed for machine control.

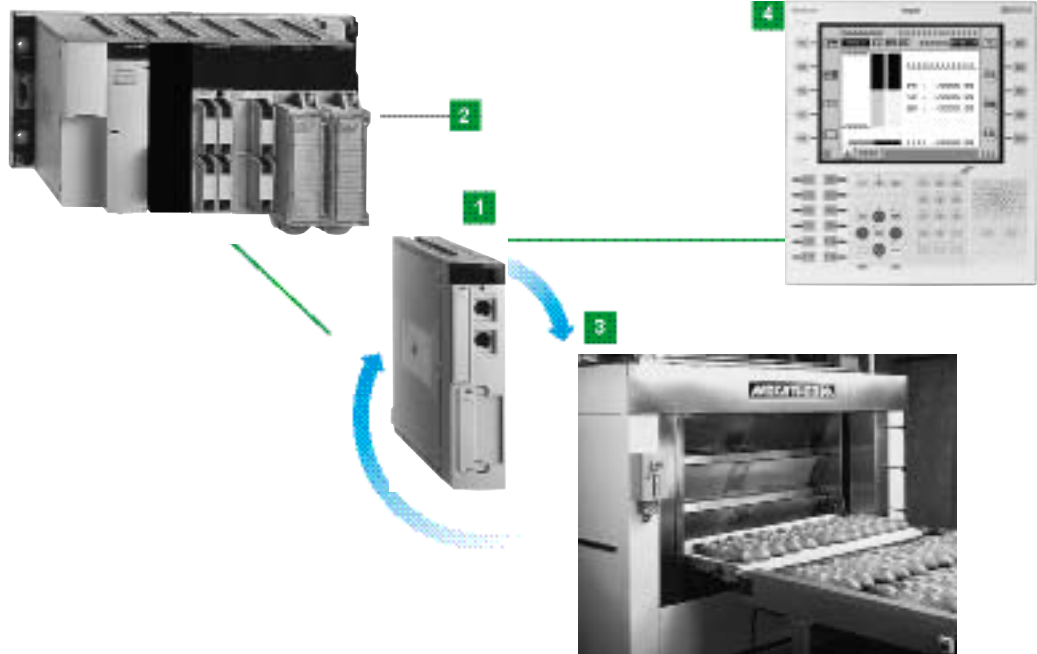

#### User-definable process control functions

TSX™ P57 2●3/2●23/3●3/3623/453/4823M processors can be used, depending on the model, to manage 10 to 20 control channels (of 3 loops each).

These channels can be configured in order to execute algorithms used in industrial processes:

- Cascaded loop.
- Process loop.
- Autoselective loop.
- Setpoint programmer.
- Controller with three simple loops.

#### Inputs/outputs

TSX P57 2●3/2●23/3●3/3623/453/4823M processors manage an entire station consisting of racks connected on Bus X.

The I/O interfaces necessary for process control processing are analog or discrete module channels in:

- In-rack I/O modules.
- Advantys™ STB or Momentum™ distributed I/O modules.

#### Control loops

The software setup of control loops is performed by entering parameters (Plug and Play technology) when configuring the TSX P57 processor.

The user completes predefined loop diagrams which also integrate management of the operating mode and the link with the I/O.

#### Operator dialog and control

Magelis® operator dialog terminals have preconfigured screens dedicated to process control which simplify loop operation and control. These screens show the controller front panels as well as trending views and monitoring views.

### Presentation

TSX™ P57 2●3/2●23/3●3/3623/453/4823M processors can be used to configure 10, 15 or 20 continuous or semi-continuous process control channels.

The control functions of these processors are particularly suitable for:

- Sequential processing requiring auxiliary control functions such as packaging machines, surface treatment machines, presses, etc.
- Simple processes such as metal processing furnaces, ceramic furnaces, refrigeration units, etc.
- Feedback or mechanical control where sampling time is critical, eg torque control, speed control, etc.

Modicon® Premium™ processors have, amongst others, the following characteristics:

- Each configurable control channel can be used to manage 1 to 3 loops depending on the type of loop chosen.
- Process control processors can be inserted in the overall architecture of a site as the PLC can be integrated in various communication networks.
- Calculations related to process control are performed in floating point mode, expressed as physical units.

Description: TSX P57 ●●3/●●23M processors, see page 1/27.

Characteristics and performance, see page 1/28.

### Functions

#### Control loops

Modicon™ Premium™ processors can be used to set up 10 to 20 control channels, each one adopting one of the following 5 loop profiles:

- Process loop: loop with a single controller.
- Controller with 3 simple loops: controller which can increase the capacity of the number of loops.
- Autoselective loop also known as secondary: comprised of 2 loops in parallel with an output selection algorithm.
- Cascaded loop: comprised of 2 dependent loops (the master loop output is the slave loop setpoint).
- Setpoint programmer: comprised of a maximum of 6 compound profiles with a total of 48 segments.

Since the channels are independent, configuration of 10 channels can be used to obtain:

- 30 simple loops.
- 5 setpoint programmers, each one associated with 5 control loops.
- 2 setpoint programmers and 8 process loops.

The various loops are characterized by:

- Their different algorithms.
- 5 processing branches (process value, setpoint, Feed Forward, loop controller and output processing).
- Calculation functions (gain, filtering, square root, etc) defined using parameters.

#### Type of control loops

Predefined algorithms, whose parameters can be defined by the user, are shown below:

Process loop

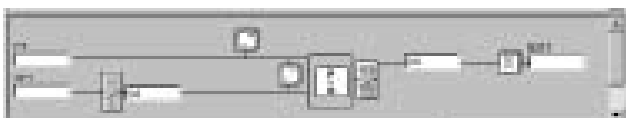

Simple loop



Autoselective loop

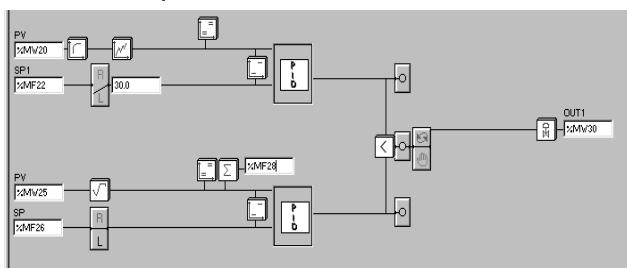

Cascaded loop

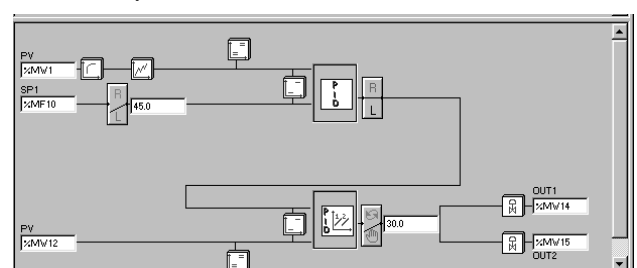

### Processing branches

Parameter definition (choice of functions to be used) of control loop profiles enables the algorithm to be adapted to the process to be controlled.

### Process value processing

Process value processing can be performed either in standard fashion or externally.

- Standard processing, the user has the following functions at his disposal: filtering, process value between limits, function generator with scaling, alarm management on threshold overrun, totalizer and simulation of the measured value.
- External processing is used to obtain, at the loop controller input, a process value, PV, which was processed outside the control loop. This solution is useful if measurement calculation of the process value requires specific or customized functions.

### Setpoint processing

Depending on the type of loop chosen, it is possible to opt for one of the following 4 setpoints: ratio setpoint, selection setpoint, simple setpoint (remote with scaling) or setpoint programmer.

When using the controller with 3 single loops or the secondary loop (in an autoselective loop), only the simple setpoint and the setpoint programmer can be used.

### Feed Forward processing

Feed Forward processing corrects a measurable disturbance as soon as it appears. This open loop processing anticipates the effect of the disturbance. It has the Leading function (phase lead/lag).

### Loop controller and command processing

There are 6 different types of loop controller to choose from: autotuning PID, controller in discrete mode with 2 or 3 states, hot/cool controller (PID or autotuning model) or Split Range controller (PID or autotuning model).

### Output processing

There are 3 types of output processing: analog output, servomotor output or PWM output. Whatever the type of output, the control calculated by the controller crosses a ramp limiter and a limiter where the lower and higher limits can be used to define the output variation range.

### Setpoint programmer

The setpoint programmer offers a maximum of 6 profiles with a total of 48 segments. It is therefore possible to create a 48-segment programmer, six 8-segment programmers or one 24-segment programmer with one 16-segment programmer and one 8-segment programmer, etc.

Each segment is configured as a ramp or dwell time. It is characterized by:

- The setpoint to be reached.
- Duration of the segment or gradient of the segment (if a ramp).

A profile can be executed once, a certain number of times or continually looped back. Moreover, due to the concept of specified dwell time, the time will only need to be downcounted if the process value is actually in the specified range.

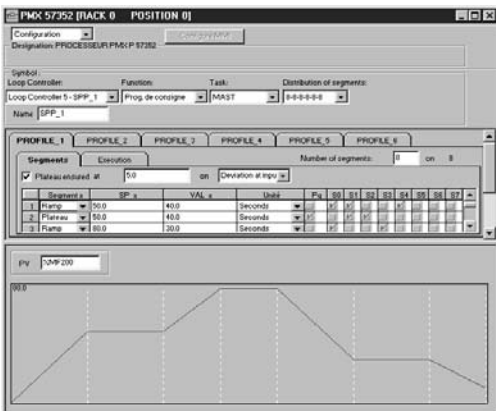



#### Configuration of control channels

Special screens, accessible using PL7™ Junior/Pro software, enable the configuration of control loops.

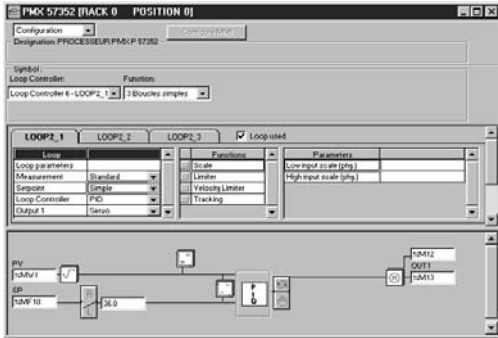

Configuration of control channels

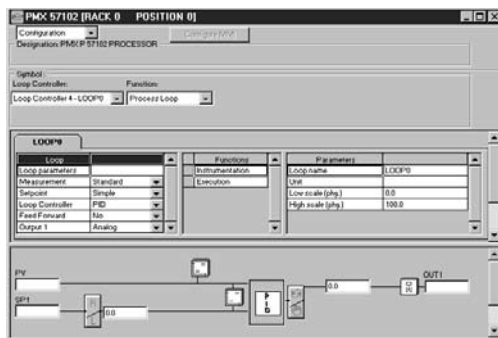

Configuration of a process loop

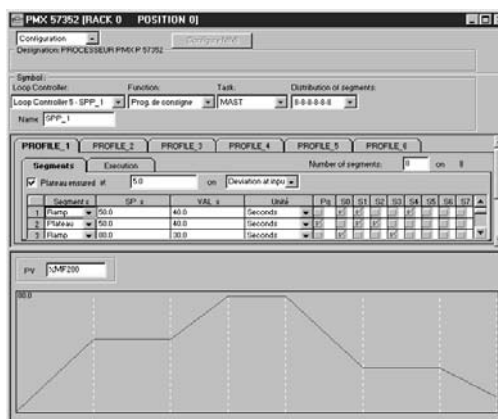

Defining the cycles of profiles

#### Configuration of control channels

By simply selecting from the menus, the “Loops” interface on PMX process control processors enables the following to be configured:

- The type of loop (out of the 5 existing ones).
- The choice of functions used in the 5 processing branches.
- Parameters linked to each function.
- Assignment of PLC variables to different loop branches (memory words, input words or output words depending on the processing branch).
- Automatic presymbolization of variables used in the loops.

Configuration of process, single, autoselective and cascaded loops proposes parameter entry by default. The various functions integrated in the algorithms (square root, function generator, etc) and the initial value of each parameter are predefined.

#### Example: configuration of process loop

Once the type of loop has been chosen, parameter entry is performed by selecting or deselecting options in the processing branches. No programming is therefore necessary, loop diagrams are enhanced or simplified as parameters are validated. The screen opposite shows how selecting the PID controller can display the various parameters valid for this type of controller (KP, TI, TD, etc).

For the setpoint programmer, configuration of the various profiles (6 maximum) is done using a table defining each segment.

Once the type of segment has been chosen (ramp or dwell time), configuration consists of defining the setpoint to be reached (for the ramp) and duration (for the ramp or dwell time).

While making selections, the lower part of the screen shows the profile display with the setpoint limit values.

This screen also allows the cycles of this profile to be defined: execution once, a certain number of times or continually looped back (32,767 times maximum).

#### Execution of control channels

The loop sampling period is predefined at 300 ms. This defines the loop controller processing period in automatic mode. It is possible to modify this period in the loop configuration screen.

The user can access the I/O and parameters for the various configured control channels via the program or by using the various PL7 Junior/Pro software tools (in particular language editors and animation tables).

### Debug functions

Adjustment and debugging of control loops is performed in a simple and user-friendly way using the loop configuration application-specific screen which, when online, can access the following functions:

- Display and animation of the loop algorithm diagram.
- Display of alarms linked to the process and detected channel faults.
- Simulation of input interface values: for example when they are not connected (process value, Feed Forward).
- Addition, removal or replacement of calculation functions in online mode.
- Modification of adjustment parameters for each function.
- Modification of loop controller operating modes and manual control.

With the controllers integrated in control loops, it is possible to use the autotuning function which calculates a set of adjustment parameters ( $K_p$ ,  $T_i$ ,  $T_d$  or  $K_s$ ,  $T_1$ ,  $T$ -delay) upon request.

Once the loop has been debugged, it is possible to save the current test values as the initial loop parameter values. Hence, on restarting the loop, it will contain the correct values.

### Loop debugging

The debugging screen:

- Displays the values of variables linked to the loop dynamically.
- Shows the parameters chosen (or can even modify them).
- Displays alarms.

The menus enable manual control of the loop, autotuning, parameter backup, etc.

### Setpoint programmer debugging

Setpoint programmer channels have their own debugging screen which displays:

- The number of the current segment and the iteration number.
- Execution time of the current segment.
- Overall execution time.

### Runtime screens

The runtime screen tool available in PL7™ Pro software integrates front panel views and trending views in its object library which can be used to adjust and operate control loops.

### Front panel views and trending views

Predefined controller front panel views provide the user with the traditional appearance of controller front panels. The user only enters the variables used by the loop being dealt with in the various fields in this view.

Similarly, trending views display changes in loop parameters in graph form as well as useful operating information: operating mode, alarms, etc.



Loop debugging

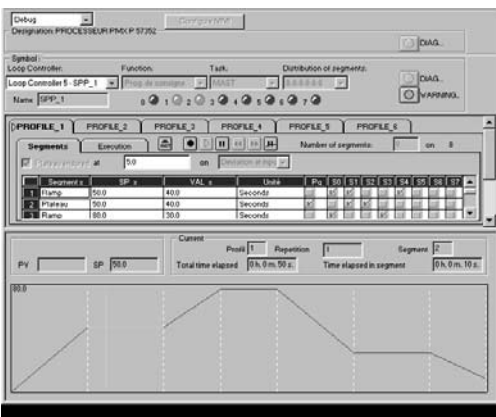

Setpoint programmer debugging

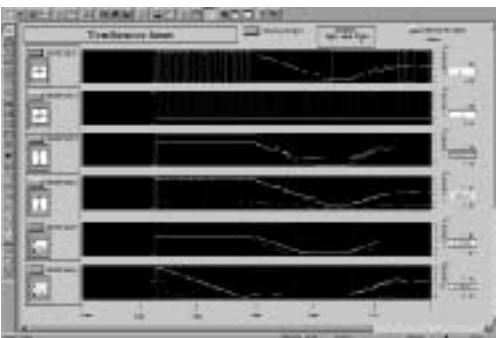

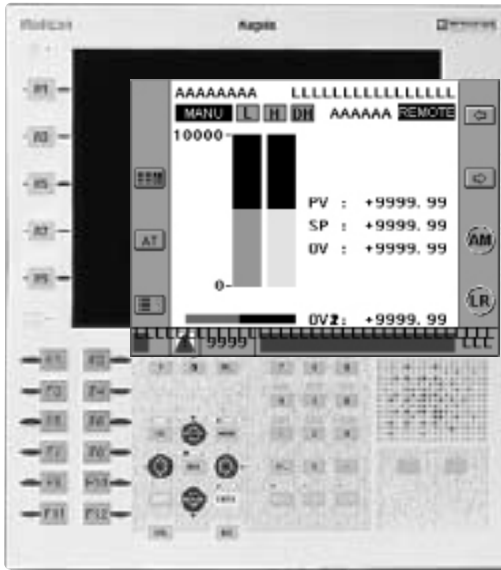

### Control and operation

Tools integrated in PL7™ software (loop debugging screens, runtime screens, etc) which are associated with XBT F Magelis® graphic screen terminals offer screens dedicated to the control and operation of control loops.

### Setup

These predefined screens offer runtime and control views.

Standard PL7™ Junior/Pro software contains the application developed with XBT L1003/L1004 development software, which is comprised of predefined runtime and control views. When using this dialog application, animation of runtime and control views is automatic.

### Presentation of views

Each control loop is associated with a certain number of views depending on the size of the Magelis® terminal screen.

■ With 5" screen terminals, the user has 7 views at his disposal:

- monitoring view,
- front panel (bar chart),
- supervisory control view (trending),
- adjustment view,
- autotuning view,
- setpoint programmer view,
- alarm view.

With this type of terminal, it is possible to operate 8 loops.

■ With 10" screen terminals, the user has 5 views at his disposal:

- monitoring view,
- front panel view integrating the display of the front panel, loop adjustment and autotuning,
- supervisory control view,
- setpoint programmer view,
- alarm view.

With this type of terminal, it is possible to operate 16 loops.

Runtime pages are based on the same presentation module:

■ An alarm zone is positioned at the bottom of the screen. It shows the last active alarm.

■ Dynamic function keys execute one and only one function (access to the adjustment page, starting autotuning, navigation between the various pages, selecting a loop, etc.).

It is of course possible for the user to customize the screens to suit their specific requirements.

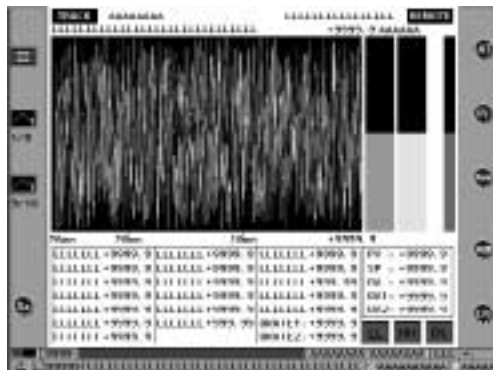

Adjustment view

# Modicon® Premium™ automation platform

## Vijeo® Citect® supervisory software



### Presentation

The flexibility of Vijeo® Citect® supervisory software enables users to achieve the solution that best suits their supervision requirements for installations.

Vijeo Citect offers the functions of a modern supervisor. Its distributed client-server architecture is applicable to a multitude of applications in various industries:

- Oil and Gas,
- MMM - Mining, Metals and Minerals,
- WWW - Water and Wastewater treatment,
- Power,
- Food and Beverage,

Also, Vijeo Citect's flexibility allows it to fit the requirements in many other applications like distribution facilities, airports, etc.

A unique development tool enabling the development of any supervision application, from small stand-alone systems to large distributed redundant systems.

Application designers and users benefit from the expertise of Schneider Electric in system integration. Moreover the offer is continuously updated in order to make the last technologies available to the customers.

### Redundancy

Vijeo Citect offers total redundancy.

The redundancy functions are fully integrated within the system and are intuitive to configure.

### Server license

Vijeo® Citect® exists:

- in a **Client-Server** architecture and ranges from 75 Points to an unlimited number of Points,
- in a **stand-alone** version called **Vijeo® Citect® Lite** that can manage 300, 600 or 1200 Points, see page 6/95.

Vijeo Citect automatically installs OFS™, the OPC server of Schneider Electric. This does not require registration. This component can only be used with Vijeo Citect software.

OFS™ software provides access to any of the PLC variables: Elementary Data type, Derived Data type and Function Blocks. Furthermore OFS periodically checks the consistency between the PLC applications and SCADA application. This is a major benefit provided by Schneider Electric's extensive experience in system integration.

Server licenses **VJC 1011 ●●** are purchased by number of Points that are required for processing, not I/O (1). An upgrade offer **VJC 1011 1●●●** is available for increasing the number of Client and Server Points if required at a later date (2).

(1) Vijeo Citect counts the variables exchanged with external devices, such as PLCs.  
 (2) If the Server or Client is upgraded, the keys must be reprogrammed

Web-enabled Power & Control

Transparent  
Ready™

## Client license

Client licenses are generally purchased using the same Points Count as the Server to which they are connected. Four types of Clients are available:

- **Display Client, VJC 1020 ●●**: used by operators accessing the Vijeo® Citect® Server through a local connection,
- **Manager Client, VJC 1030 ●●**: for users needing to view the Vijeo Citect application via a local connection, but not needing to control the system,
- **Web Display Client, VJC 1022 ●●**: similar to Display Client but through a Web connection,
- **Web Manager Client, VJC 1032 ●●**: similar to Manager Client but via the Web.

## Static, Floating and Redundant Client license

According to requirements, a Client license can either be Static, Floating or Redundant:

- **Static Client license**: for operators that must have immediate access to the system, irrespective of the number of connections already established by other Clients.

A Static Client license helps to ensure permanent access to the control system since it physically resides in the key plugged into the Client PC.

- **Floating Client license**: Users who need to occasionally use a Client for operator tasks can purchase Floating licenses. Connections will be allowed provided that the number of valid licenses is not exceeded. Floating Client licenses are stored on the key plugged into the Server.

- **Redundant Client license**: Redundant Client licenses **VJC 10●● 88** are solely intended for the Standby Server in a Redundant configuration. They are used to help ensure that the number of Client licenses purchased are available.

## Development workshop

Development workshop **VJC 1099 ●2** is comprised of the physical items such as the CD-ROM, hardware keys, installation guide and storage boxes.

Set up:

- each Server requires a hardware key (USB or parallel) in order to operate,
- the Server key is also used to store the Floating Client licenses,
- the key controls the number of Points that can be used,
- the key is programmed to operate up to predetermined version.

## Promotional and Evaluation License

A development workshop Promotional License **VJC 1095 ●●** is available. It is only available for teaching purposes and meets requirements for demonstrations and testing.

With an Evaluation License it is possible to develop an application and test it for 10 minutes in stand-alone mode.

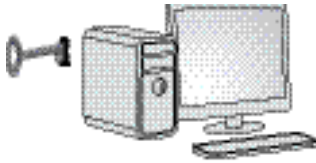

Single station architecture

**Architectures**

**SCADA system stand-alone single station, 5000 Points**

**Development workshop**

- 1 x VJC 1099 22, physical delivery of the CD with USB key.

**Server license**

- 1 x VJC 1011 14, Server license for 5000 Points, including Server Client.

**Client license**

- Not required, included in the Server license.



Single server architecture with Web Manager Client access

**Remote Server system with remote access via the Web**

**Development workshop**

- 1 x VJC 1099 22, physical delivery of the CD with USB key.

**Server license**

- 1 x VJC 1011 15, Server license for 15000 Points, including Server Client.

**Client license**

- 1 x VJC 1032 15, Web Manager Client license for 15000 Points.

6

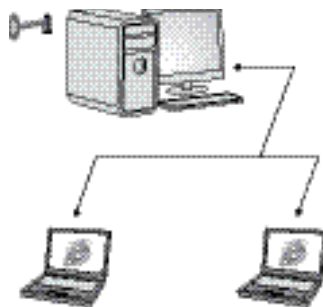

Single server architecture with 1 Web Display Client and 1 Web Manager Client

**Networked Server system with remote Web Clients**

Example: Networked Server system, 500 Points, with 2 remote Clients via the Web: one Web Display and one Web Manager.

**Development workshop**

- 1 x VJC 1099 22, physical delivery of the CD with USB key.

**Server license**

- 1 x VJC 1011 12, Server license for 500 Points, including Server Client.

**Client licenses**

- 1 x VJC 1022 12, Web Display Client license for 500 Points.
- 1 x VJC 1032 12, Web Manager Client license for 500 Points.

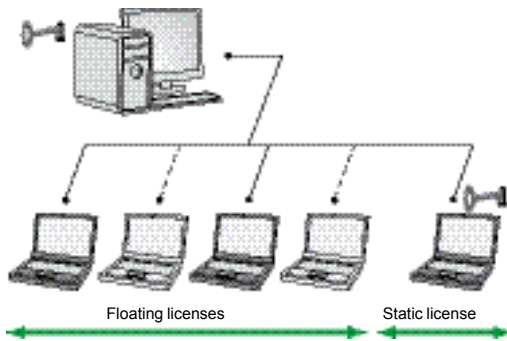

Single server architecture with 2 Floating Display Client licenses and 1 Static license

## Architectures (continued)

### Networked server system with floating and static access

Example: Networked Server system, 5000 Points, with 5 Client PCs and 3 Client licenses, including 2 Floating licenses and 1 Static license.

#### Development workshop

- 1 x VJC 1099 22, physical delivery of the CD with USB key.
- 1 x VJC 1099 21, additional USB key for Static Client.

#### Server license

- 1 x VJC 1011 14, Server license for 5000 Points, including Client Server (local Display Client type on the Server PC).

#### Client licenses

- 3 x VJC 1020 14, Display Client licenses for 5000 Points.

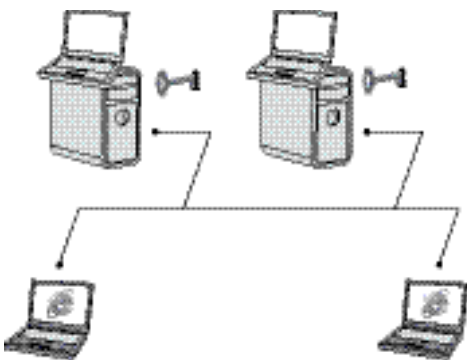

Redundant architecture with 2 Display Clients on servers and 2 Web Manager Clients

### Redundant server with Server Display Clients and Web Manager Clients

Example: Redundant server, 1500 Points, with 2 Display Clients on the Servers and 2 Web Manager Clients.

#### Development workshop

- 1 x VJC 1099 22, physical delivery of the CD with USB key: Primary server key.
- 1 x VJC 1099 21, additional USB key for Standby Server (rule: 1 key per Server).

#### Server licenses

- 2 x VJC 1011 13, Server licenses for 1500 Points, including Server Client.
  - the first Server acts as the Primary Server,
  - the second Server acts as the Standby Server,
  - one license will be placed on each key (Primary and Standby).

#### Client licenses

- 2 x VJC 1032 13, Web Manager Client licenses for 1500 Points.
  - these 2 licenses will be placed on the Primary Server key.

#### Redundant Client license:

- 2 x VJC 1032 88, Redundant Web Manager Client licenses
  - floating Redundant licenses for Web Manager Client licenses,
  - these 2 licenses will be placed on the Standby Server key.

# Modicon® Premium™ automation platform

## Vijeo® Citect® supervisory software



VJC 1099 22/12



VJC 1099 21

VJC 1099 11



### Development workshop - Vijeo® Citect® Box and key(s)

Vijeo® Citect® Box VJC 1099 ●2 includes:

- 1 CD-ROM with Vijeo Citect software,
- Schneider Electric drivers pack,
- an installation guide,
- a hardware key.

Additional keys are also delivered in the Vijeo Citect Box.

### Development workshop - Vijeo Citect Box

Description	Type of key included	Reference	Weight kg
Vijeo Citect Box USB key	USB	VJC 1099 22	0.410
Vijeo Citect Box Parallel key	Parallel	VJC 1099 12	0.420

### Additional Vijeo Citect keys

Description	Target license	Reference	Weight kg
Additional Vijeo Citect USB key Delivered in Vijeo Citect Box	Redundant Server and Static (non-floating) licenses.	VJC 1099 21	–
Additional Vijeo Citect parallel key Delivered in Vijeo Citect Box	Redundant Server, Static (non-floating) and demonstration licenses.	VJC 1099 11	–

### Vijeo® Citect® Lite, stand-alone

The Vijeo Citect Lite stand-alone license, for 300, 600 or 1200 Points, includes:

- 1 CD-ROM with Vijeo Citect software,
- Schneider Electric drivers pack,
- an installation guide,
- a hardware key.

A simple solution for stand-alone applications, a Vijeo Citect Lite license is used for connecting a single client to a single sector. It cannot be made redundant.

A Vijeo Citect Lite license can be upgraded to a full Vijeo Citect license (1).

### Vijeo Citect Lite license

Description	Number of Points	Reference	Weight kg
Vijeo Citect Lite	300	VJC 3011 27	–
Stand-alone: no connectivity	600	VJC 3011 59	–
Key to be ordered separately	1200	VJC 3011 50	–

### Vijeo Citect Lite upgrades

The references indicated below are for upgrading the number of Vijeo Citect Lite Points:

- regarding the number of Points in the Lite version,
- from Vijeo Citect Lite to the full Vijeo Citect Server version (see below).

Description	Number of Points	Reference	Weight kg
Vijeo Citect Lite number of Points upgrade	300 to 600	VJC L27 L59	–
	600 (2) to 1200	VJC L59 L50	–
Vijeo Citect Lite to Vijeo Citect Server upgrade	300 Lite to 600 Server	VJC L27 F12	–
	600 Lite (2) to 1500 Server	VJC L59 F13	–
	1200 Lite to 1500 Server	VJC L50 F13	–

(1) Requires reprogramming of key VJC 1094 00.

(2) Also for existing Lite 500 Point versions installed





### Vijeo® Citect® Server

Vijeo® Citect® Server licenses (complete system), graded by the number of points Points, include:

- 1 CD-ROM with Vijeo Citect including OFS and SpeedLink,
- Schneider Electric drivers pack,
- an installation guide,
- a hardware key.

#### Redundant system

For a redundant system simply order 2 Server licenses.

No other option is required regarding the Servers.

The programmed key (USB or parallel) must be ordered separately.

#### Vijeo Citect Server license

Description	Number of Points	Reference	Weight kg
<b>Vijeo Citect Server</b>	75	<b>VJC 1011 10</b>	–
Full version.	150	<b>VJC 1011 11</b>	–
Key to be ordered separately.	500	<b>VJC 1011 12</b>	–
	1500	<b>VJC 1011 13</b>	–
	5000	<b>VJC 1011 14</b>	–
	15000	<b>VJC 1011 15</b>	–
	Unlimited	<b>VJC 1011 99</b>	–

#### Vijeo Citect Server upgrade

The references indicated below are for upgrading the number of Points on the Server.

Description	Number of Points	Reference	Weight kg
<b>Vijeo Citect Server upgrade</b>	75 to 150	<b>VJC 1011 10 11</b>	–
	150 to 500	<b>VJC 1011 11 12</b>	–
	500 to 1500	<b>VJC 1011 12 13</b>	–
	1500 to 5000	<b>VJC 1011 13 14</b>	–
	5000 to 15000	<b>VJC 1011 14 15</b>	–
	15000 to Unlimited	<b>VJC 1011 15 99</b>	–

# Modicon® Premium™ automation platform

## Vijeo® Citect® supervisory software

### Vijeo® Citect® Display Client

Vijeo® Citect® Display Client licenses are intended for operators. Licenses for these Clients are graded according to the number of Points to be displayed. They can either use:

- a Floating license, residing on the Server key,
- a Static license: requiring a separate key on the Client PC.

#### Redundant system

- the number of Floating Clients ordered is added to the Primary Server key,
- for the Standby Server, the same number of Redundant Display Client licenses **VJC 1020 88** must be ordered.

#### Vijeo Citect Display Client license

Description	Number of Points	Reference	Weight kg
Vijeo Citect	75	<b>VJC 1020 10</b>	–
Display Client licence	150	<b>VJC 1020 11</b>	–
	500	<b>VJC 1020 12</b>	–
	1500	<b>VJC 1020 13</b>	–
	5000	<b>VJC 1020 14</b>	–
	15000	<b>VJC 1020 15</b>	–
	Unlimited	<b>VJC 1020 99</b>	–

Description	Details	Reference	Weight kg
Vijeo Citect Redundant Display Client licence	Floating license only	<b>VJC 1020 88</b>	–

### Vijeo® Citect® Manager Client

Vijeo® Citect® Manager Client licenses are available for users who need to view the application, without controlling it. Licenses for these Clients are graded according to the number of Points to be displayed. They can either use:

- a Floating license, residing on the Server key,
- a Static license, the hardware key being plugged into the Client station.

#### Redundant system

- the number of Floating Clients ordered is added to the Primary Server key,
- for the Standby Server, the same number of Redundant Manager Client licenses **VJC 1030 88** must be ordered.

#### Vijeo Citect Manager Client license

Description	Number of Points	Reference	Weight kg
Vijeo Citect	75	<b>VJC 1030 10</b>	–
Manager Client licence	150...unlimited	<b>VJC 1030 99</b>	–

Description	Details	Reference	Weight kg
Vijeo Citect Redundant Manager Client licence	Floating license only	<b>VJC 1030 88</b>	–

# Modicon® Premium™ automation platform

## Vijeo® Citect® supervisory software



### Vijeo® Citect® Web Display Client

Vijeo® Citect® Web Display Client licenses are intended for users who need full control of the application but prefer the flexibility of access via a Web connection. These Client licenses are graded according to the number of Points displayed and must be of the floating type (residing on the key plugged into the Server).

#### Redundant system

- the number of floating Clients ordered is added to the Primary Server key,
- for the Standby Server, the same number of Redundant Web Display Client licenses **VJC 1030 88** must be ordered.

#### Vijeo Citect Web Display Client license

Description	Number of Points	Reference	Weight kg
Vijeo Citect	75	<b>VJC 1022 10</b>	–
Web Display Client license	150	<b>VJC 1022 11</b>	–
	500	<b>VJC 1022 12</b>	–
	1500	<b>VJC 1022 13</b>	–
	5000	<b>VJC 1022 14</b>	–
	15000	<b>VJC 1022 15</b>	–
	Unlimited	<b>VJC 1022 99</b>	–

Description	Details	Reference	Weight kg
Vijeo Citect Redundant Web Display Client license	Floating license only	<b>VJC 1022 88</b>	–

### Vijeo® Citect® Web Manager Client

Vijeo® Citect® Web Manager Client licenses are intended for users who need to view the application via a Web connection, without controlling the system. These Client licenses are graded according to the number of Points displayed and must be of the floating type (residing on the key plugged into the Server).

#### Redundant system

- the number of Floating Clients ordered is added to the Primary Server key,
- for the associated Standby server, the same number of Manager Client Redundant licenses **VJC 1032 88** must be ordered.

#### Vijeo Citect Web Manager Client license

Description	Number of Points	Reference	Weight kg
Vijeo Citect	75	<b>VJC 1032 10</b>	–
Web Manager Client license	150...unlimited	<b>VJC 1032 99</b>	–

Description	Details	Reference	Weight kg
Vijeo Citect Redundant Web Manager Client license	Floating license only	<b>VJC 1032 88</b>	–

### Display Client upgrade

The references indicated below are for upgrading the number of Points on:

- the Server in which the hardware key is plugged, for floating licenses,
- the Client in which the hardware key is plugged, for static licenses.

#### Vijeo® Citect® Display Client upgrade (1)

Description	Number of Points	Reference	Weight kg
Vijeo Citect	75 to 150	VJC 1020 10 11	–
Display Client upgrade	150 to 500	VJC 1020 11 12	–
	500 to 1500	VJC 1020 12 13	–
	1500 to 5000	VJC 1020 13 14	–
	5000 to 15000	VJC 1020 14 15	–
	15000 to Unlimited	VJC 1020 15 99	–

### Manager Client upgrade

The references indicated below are for upgrading the number of Points on:

- the Server in which the hardware key is plugged, for floating licenses,
- the Client in which the hardware key is plugged, for static licenses.

#### Vijeo Citect Manager Client upgrade (1)

Description	Number of Points	Reference	Weight kg
Citect	75 to 150	VJC 1030 10 11	–
Manager Client upgrade	150 to 500	VJC 1030 11 12	–
	500 to 1500	VJC 1030 12 13	–
	1500 to 5000	VJC 1030 13 14	–
	5000 to 15000	VJC 1030 14 15	–
	15000 to Unlimited	VJC 1030 15 99	–

### Web Display Client upgrade

The references indicated below are for upgrading the number of Points on:  
the Server in which the hardware key is plugged.

#### Vijeo Citect Web Display Client upgrade (1)

Description	Number of Points	Reference	Weight kg
Vijeo Citect	75 to 150	VJC 1022 10 11	–
Web Display Client upgrade	150 to 500	VJC 1022 11 12	–
	500 to 1500	VJC 1022 12 13	–
	1500 to 5000	VJC 1022 13 14	–
	5000 to 15000	VJC 1022 14 15	–
	15000 to Unlimited	VJC 1022 15 99	–

### Web Manager Client upgrade

The references indicated below are for upgrading the number of Points on:  
the Server in which the hardware key is plugged.

#### Vijeo Citect Web Manager Client upgrade (1)

Description	Number of Points	Reference	Weight kg
Vijeo Citect	75 to 150	VJC 1032 10 11	–
Web Manager Client upgrade	150 to 500	VJC 1032 11 12	–
	500 to 1500	VJC 1032 12 13	–
	1500 to 5000	VJC 1032 13 14	–
	5000 to 15000	VJC 1032 14 15	–
	15000 to Unlimited	VJC 1032 15 99	–

(1) The reprogramming fee VJC 1094 00 is applicable for any key upgrade.

# Modicon® Premium™ automation platform

## Vijeo® Citect® supervisory software

### Vijeo® Citect® - Specific drivers

The Vijeo Citect offer includes an extensive number of drivers as standard. However, for copyright reasons, some drivers have a specific reference and they must be ordered separately. Purchasing a specific driver includes access to the appropriate technical support for the driver for one year.

Description	Protocol	Reference	Weight kg
Vijeo Citect specific driver	IEC 60870-5-104	<b>VJC 3051 41</b>	–
	PSDirect ETH	<b>VJC 3051 40</b>	–
	PSDirect MPI	<b>VJC 3051 42</b>	–
	Bailey	<b>VJC 3051 44</b>	–
	SEMAPI	<b>VJC 3051 48</b>	–
	MOSCAD	<b>VJC 3051 49</b>	–

**Note:** Before ordering a Vijeo Citect specific driver, please consult your Schneider Electric Regional Sales Office.

### Vijeo Citect - Key reprogramming

Any reprogramming of the Vijeo Citect key is subject to order reference

#### VJC 1094 00:

- upgrading the number of Points,
- adding Clients,
- upgrading a Vijeo Citect Lite license to a full Vijeo Citect license,
- exchanging a parallel key for a USB key.

**Note:** If a new key is required, purchase an additional Vijeo Citect key, see page 36375/6.

Description	Reference	Weight kg
Vijeo Citect Key reprogramming	<b>VJC 1094 00</b>	–

### Vijeo Citect Support

From the second year of ownership of one or more Vijeo Citect licenses, Vijeo Citect Support enables the user to continue receiving the benefits of full support for the installed base. One of the services included in this offer is the supply of the latest version updates.

Description	Details	Reference	Weight kg
Support	For Vijeo Citect software and licenses	<b>VJC 1091 01</b>	–
	For Vijeo Citect specific drivers	<b>VJC 1091 01D3</b>	–

### Third-party applications converter

Switch 2 Vijeo Citect™ is a conversion tool that helps to convert legacy SCADA to Vijeo Citect. Its allows the tag database and graphic information to be reproduced inside Vijeo Citect. The conversion rate depends upon the complexity of the application and can vary from 15 % to 80 %.

Description	Details	Reference	Weight kg
Switch 2 Vijeo Citect™	Third-party applications converter	<b>VJC 1090 88</b>	–

### Vijeo Citect Loan key

Description	Details	Reference	Weight kg
Vijeo Citect Loan key USB key only (1)	Provides temporary access to a key (2). 8 days continuous usage. The hardware key must be returned at the end of the loan period.	<b>VJC 1095 03</b>	–

(1) Also requires an "additional USB key" **VJC 1099 21**.

(2) The quantity to be ordered equals the number of months of the required loan period.

# Modicon® Premium™ automation platform

## OPC® Standard OPC Factory Server (OFS)™ software

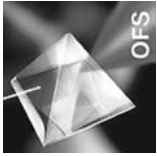

Web-enabled Power & Control  
**Transparent**  
**Ready™**

### Presentation

Schneider Electric's OPC Factory Server (OFS)™ software is based on the OLE for Process Control (OPC™) standard. It allows "client" software applications, such as supervisors/SCADA and customized interfaces - to access the data of Schneider Electric's automation systems and electrical distribution devices - by connecting to networks or field bus in real time.

It also allows communication with third party devices supporting Modbus® and Modbus®/TCP protocols.

At the heart of the Schneider Electric Transparent Ready® offer, OFS™ enables simpler, more open and transparent communication between your software applications and your devices. These are just some of the advantages that help to ensure a complete, interoperable solution that is central to your process.

In version V3.3, the OFS™ data server integrates the most recent specifications of the OPC® Foundation:

- **OPC-DA** (OPC Data Access)
- **.NET API interface**
- **OPC XML-DA V1.0** (OPC XML Data Access)

The OFS™ V3.3 offer is available in two levels:

- **OFS Small:** data server for 1000 items (1) that does not support the OPC XML-DA protocol
- **OFS Large:** complete server data

### Devices and protocols supported

OFS™ software is a multi-device data server: it allows simultaneous use of several communication protocols, and it provides client applications with a set of services for accessing automation system items that may be local or remote, via physical address or via symbol.

#### Devices supported:

- Modicon® Premium™, Quantum™, TSX Micro™, Compact™, and Momentum™ PLCs
- TSX™ Series 7 and April Series 1000 Schneider Electric PLCs
- Serial Modbus® devices connected via Schneider Electric gateways: TSX™ ETG 10●●, EGX ●●● ranges, etc.
- Serial Uni-Telway™ devices connected via Schneider Electric gateways (TSX ETG 1010)

#### Networks and protocols supported:

- Modbus®: Modbus serial, Modbus Plus™, Modbus/TCP
- X-Way™, UNI-TE™, Uni-Telway™, Fipway®, Ethway™, ISAWay™, PCIway™

### Openness

The development of specialized interfaces is simpler with OFS™ V3.3 software, aimed at two types of user in particular:

■ **End users** who either want to interface their supervision or human/machine interface applications with Schneider Electric equipment or to develop applications on a PC (supervisory control screens, Excel tables, etc.) requiring access to automation system data.

■ **Suppliers of automation system or industrial data processing software** (supervision, human/machine interfaces, etc.) seeking to develop, within their standard products, an OPC Client interface capable of accessing data in Schneider Electric equipment via the OFS server.

(1) item: variable, structure, table, etc. of the Unity Pro application.

# Modicon® Premium™ automation platform

## OPC® Standard

### OPC Factory Server (OFS)™ software



OPC Factory Server™: home page

#### Architectures supported

The OFS™ server allows four access modes:

- a purely local mode
- remote access from an OPC-DA client
- remote access from an OPC .NET client
- remote access from an OPC XML-DA client

#### Local access

The client application and the OFS server are on the same PC.

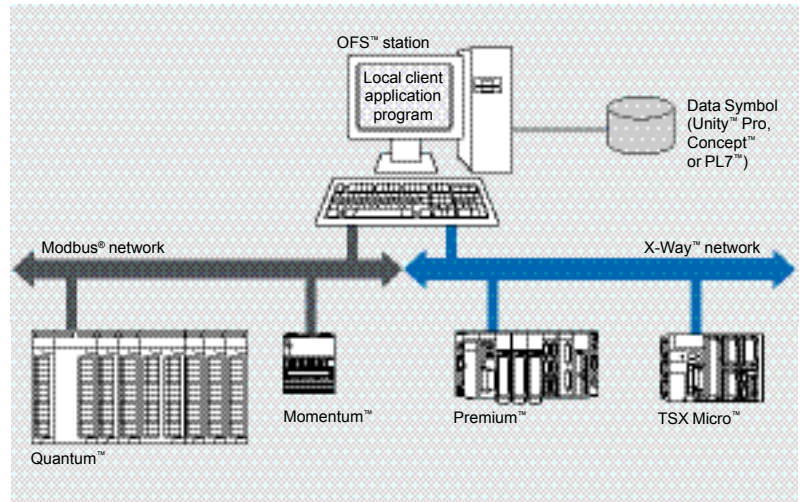

#### Remote access from an OPC-DA client

The client application and the OFS™ data server are on remote stations.

Communication between the client station and the OFS server is conducted through the DCOM layer (Microsoft) via the OPC-DA protocol.

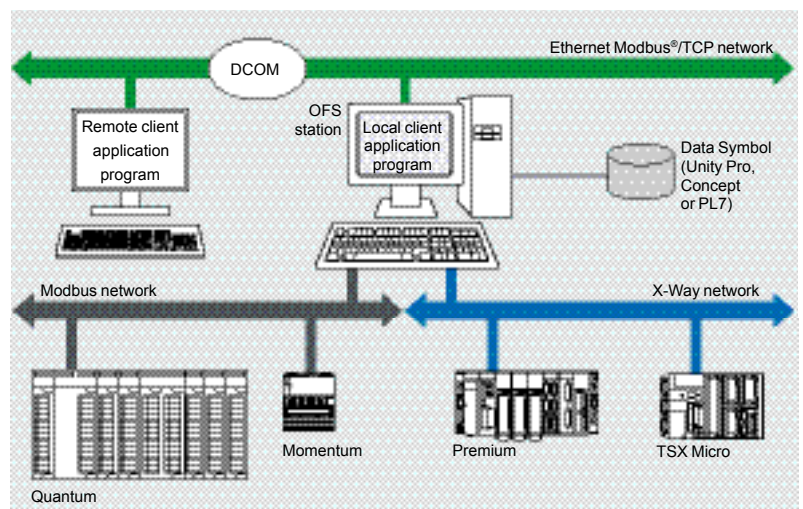

# Modicon® Premium™ automation platform

OPC® Standard  
OPC Factory Server (OFS)™ software

## Supported architectures (continued)

### Remote access from an OPC .NET client

The .NET® client application program and the OFS™ data server are on remote stations. Communication between the client station and the OFS server is conducted through the DCOM layer (Microsoft) via the OPC-DA protocol.

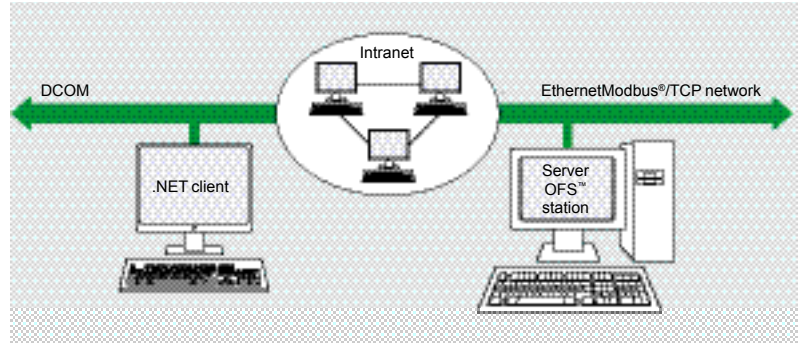

The .NET Microsoft compatibility of the OFS server has been developed to allow an OPC .NET client to access OFS server items on an Intranet network via the OPC .NET API interface.

This interface helps to ensure interoperability between existing OPC applications and applications developed in the native .NET environment

### Remote access from an OPC XML-DA client via HTTP

The client application program and the OFS server are on remote stations, using the SOAP protocol to communicate via the Internet in conformity with the OPC XML-DA V1.01 specification of the OPC Foundation. The OFS data server is based on an HTTP server installed on the same station.

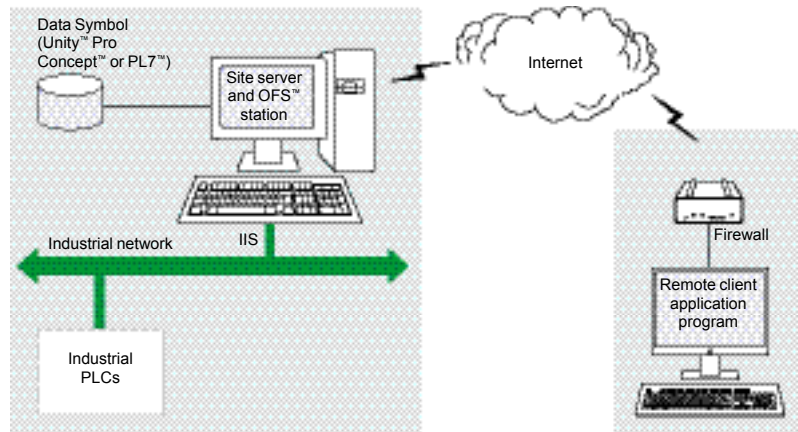

The OPC XML-DA V1.0 specifications are designed to overcome the limitations of COM/DCOM by providing:

- an OPC interface for Windows and non Windows client applications
- beyond the Intranet perimeter, remote access via the Internet through firewalls.

The OPC XML-DA specification is based on “Web Services” standards such as SOAP, XML, WSDL (1). A SOAP client can access data on the OFS server via Intranet or Internet using the SOAP protocol in conformity with the OPC XML DA V1.01 specification of the OPC foundation.

(1) SOAP: Simple Object Access Protocol  
XML: Extended Markup Language  
WSDL: Web Services Description Language



Set up

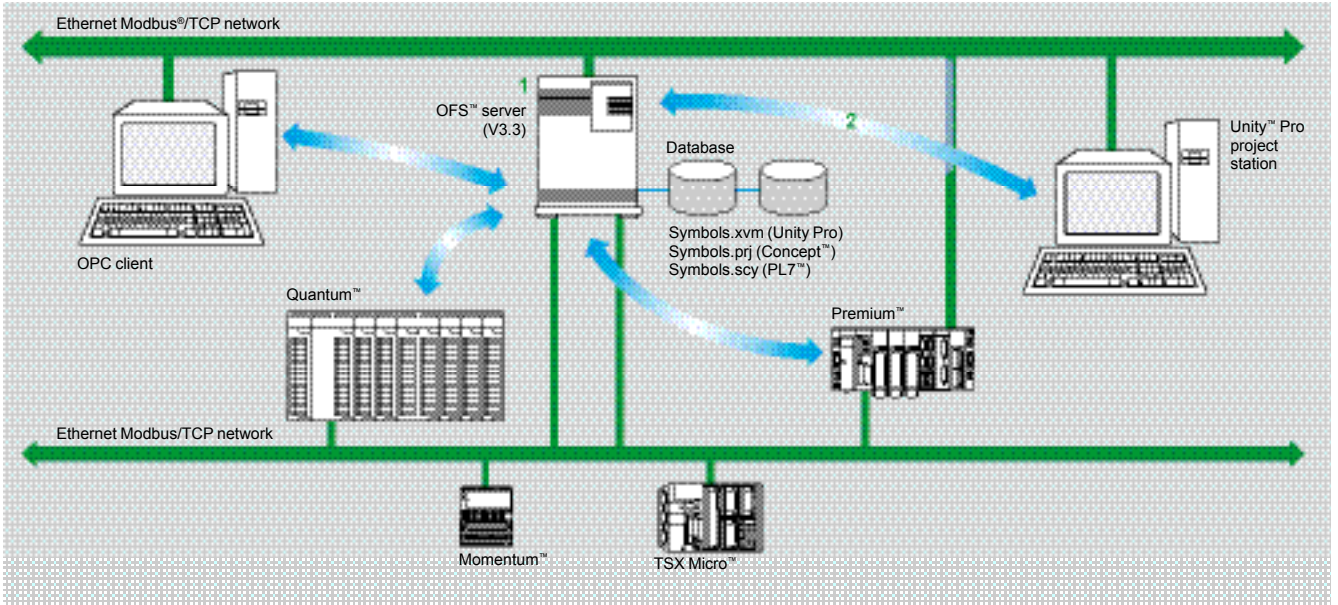

The OFS™ server **1** is the center of the data exchanges. The direct and dynamic link **2** between the OFS server and the Unity™ Pro project station results in productivity gains for designers and users of the devices. Effectively, OFS has direct access to the items in the Unity Pro project. In addition, it performs a consistency check between these items and those of the Modicon® Premium™ and Quantum™ PLCs.

**Note:** Depending on the software used for setting-up Modicon PLCs:

- PL7 software generates PLC variable symbol export files. These export files (symbols.scy) must be integrated in the OPC server.
- Concept: the variables can be accessed directly in the project (file.prj) of the Concept application. This direct link requires Concept (version > 2.0) to be installed on the OFS station **1**
- If the Unity Pro project development station is not accessible via the OFS station, the PLC variable symbol export files (symbols.xvm) generated by Unity Pro must be integrated in the OPC server.

## Functions

### Development of client applications

OFS™ software has 4 types of interface:

#### ■ OLE Automation interface (OPC-DA)

Particularly suitable for end users, it enables the development of OPC client applications in Visual Basic®, in Visual Basic for Excel, and in C++.

#### ■ OLE Custom interface (OPC-DA)

Used primarily by suppliers of automation system or industrial IT products, it enables the development of applications in C++ in order to access the OFS™ software OPC server. This interface is particularly aimed at software development experts, so that they can integrate the client application in their standard products. This is the interface with the highest performance, in terms of access time to data stored in the OPC server. It requires extensive knowledge of C++ programming to set up.

#### ■ OPC .NET API wrapper interface

The .NET Microsoft compatibility of the OFS data server gives an OPC .NET client native access to items of the OFS server via an Intranet network, helping to ensure greater interoperability with native .NET environments.

*Note: In this case, communication between the OPC .NET client and the OFS server is conducted through the DCOM layer (or COM layer in a local configuration) via the OPC-DA protocol.*

#### ■ OPC XML-DA interface (1)

The OPC XML-DA V1.0 specifications are designed to overcome the limitations of the OPC-DA specification and COM/DCOM by providing:

- an interface for Windows and non Windows client applications
- remote access via the Internet through firewalls (beyond the Intranet perimeter).

The OPC XML-DA specification is based on Web Services standards such as SOAP, XML, WSDL. A SOAP client can access data on the OFS server via Intranet or Internet using the SOAP protocol in conformity with the OPC XML-DA V1.01 specification of the OPC Foundation.

(1) Only available with the Large version of OPC Factory Server V3.3

# Modicon® Premium™ automation platform OPC® Standard OPC Factory Server (OFS)™ software



## References

OFS™ V3.3 software for PC compatible stations (minimum configuration: Pentium® 566 MHz processor, 128 MB RAM) running Windows 2000® Professional (1) or Windows XP® Professional.

The OFS V3.3 offer includes:

- OPC server software
- OPC server simulator (for debugging the application when no PLC is present)
- OFS server configuration software
- An example of OPC client for setting-up applications
- The set up documentation on CD-ROM

Supplied on CD-ROM, the software operates independently on a PC. It interfaces with the variables export files generated by PL7™, ProWORX™, Concept™ and Unity™ Pro software.

It also provides a direct and dynamic link to the Unity Pro and Concept applications (2).

OFS V3.3 software is available in two versions:

- **Small version TLX CD S●OFS 33**
  - Maximum of 1000 items
  - Only the OPC XML-DA protocol is not supported.
  - Single station and 10-station site licenses
- **Large version TLX CD L●OFS 33**
  - Full version
  - Single station, 10-station and 200-station site licenses

OPC Factory Server™ V3.3 Small			
Description	Type of license	Reference	Weight kg
OPC Factory Server V3.3 Small software	Single station	TLX CD SUOFS 33	–
	10 stations	TLX CD STOFS 33	–

OPC Factory Server™ V3.3 Large			
Description	Type of license	Reference	Weight kg
OPC Factory Server V3.3 Large Full version	Single station	TLX CD LUOFS 33	–
	10 stations	TLX CD LTOFS 33	–
	200 stations	TLX CD LFOFS 33	–

(1) Must be updated with Service Pack 1 or higher.

(2) Requires Concept version > 2.0 software to be installed on the same station.



---

## 7.1 - Human/Machine Interfaces

Selection guides:

Magelis® Small Panel display units and terminals .....	page 7/2
Magelis® Advanced Panel graphic terminals .....	page 7/4
HMI software .....	page 7/6

# Modicon® Premium™ automation platform

Operator dialog terminals  
Magelis® XBT N, XBT R, XBT RT  
Small panels

**Applications**

**Display of text messages**

**Terminal type**

**Small panels with keypad - XBT N**



<b>Display</b>	Type
	Capacity

Green backlit LCD, height 5.5 mm or Green, orange or red backlit LCD, height 4.34...17.36 mm
2 lines of 20 characters or 1 to 4 lines of 5 to 20 characters

**Data entry**

Via keypad with 8 keys (4 customizable)

<b>Memory capacity</b>	Application
	Expansion by PCMCIA type II

512 KB Flash
–

<b>Functions</b>	Maximum number of pages
	Variables per page
	Representation of variables
	Recipes
	Curves
	Alarm logs
	Real-time clock
	Alarm relay
	Buzzer

128/200 application pages 256 alarm pages
40...50
Alphanumeric
–
–
Depending on model
Access to the PLC real-time clock
–
–

<b>Communication</b>	Asynchronous serial link
	Downloadable protocols
	Printer link

RS 232C/RS 485
Uni-TE™, Modbus®, and for PLC brands: Allen-Bradley, Omron, Mitsubishi, Siemens
RS 232C serial link (2)

<b>Programming software</b>
<b>Operating system</b>

Vijeo Designer™ Lite (on Windows 2000®, XP® and Vista®)
Magelis®

**Terminal model**

**XBT N**

**Pages**

Consult our catalog "Human/Machine Interfaces"

(1) XBT RT511 only.  
(2) Depending on model

<b>Display of text messages Control and configuration of data</b>	<b>Display of text messages and/or semi-graphics Control and configuration of data</b>
---	--

<b>Small panels with keypad - XBT R</b>	<b>Small panels with touch screen and keypad - XBT RT</b>
---	---



Green, orange or red backlit LCD, height 4.34...17.36 mm	Green, orange or red backlit matrix LCD (198 x 80 pixels) height 4...16 mm
1 to 4 lines of 5 to 20 characters	2 to 10 lines of 5 to 33 characters

Via keypad with 12 function keys or numeric entry (depending on context) + 8 service keys	Via keypad with 4 function keys 8 service keys	Via touch screen and keypad with 10 function keys 2 service keys
---	--	--

512 KB Flash	512 KB Flash EPROM
-	-

128/200 application pages 256 alarm pages	200 application pages 256 alarm pages
40...50	50
Alphanumeric	Alphanumeric, bargraph, buttons, lamps
-	-
-	Yes
Yes	Yes
Access to the PLC real-time clock	
-	
-	Yes (1)

RS 232C/RS 485
Uni-TE™, Modbus®, and for PLC brands: Allen-Bradley, Omron, Mitsubishi, Siemens
RS 232C serial link (2)

Vijeo Designer™ Lite (on Windows 2000®, XP® and Vista®)
Magelis®

<b>XBT R</b>	<b>XBT RT</b>
--------------	---------------



Consult our catalog "Human/Machine Interfaces"	Consult our catalog "Human/Machine Interfaces"
--	--

# Modicon® Premium™ automation platform

## Operator dialog terminals

### Magelis® XBT GT, XBT GK, XBT GTW

#### Advanced panels

<b>Applications</b>		Display of text messages, graphic objects and synoptic views Control and configuration of data		
<b>Type of terminal</b>		Touch screen Advanced panels - XBT GT		
<b>Display</b>	Type			
	Capacity	3.8" (monochrome or color)	5.7" (monochrome or color)	7.5" (color)
<b>Data entry</b>		Via touch screen		
Static function keys		–		
Dynamic function keys		–		
Service keys		–		
Alphanumeric keys		–		
<b>Memory capacity</b>	Application	32 MB Flash EPROM	16 MB Flash EPROM	32 MB Flash EPROM
	Expansion	–	By 128, 256, 512 MB or 1 GB CF card (except XBT GT2110)	
<b>Functions</b>	Maximum number of pages	Limited by internal Flash EPROM memory capacity	Limited by the internal Flash EPROM memory capacity or CF card memory capacity	
	Variables per page	Unlimited (8000 variables max.)		
	Representation of variables	Alphanumeric, bitmap, bargraph, gauge, tank, tank level indicator, curves, polygon, button, light		
	Recipes	32 groups of 64 recipes comprising 1024 ingredients max.		
	Curves	Yes, with log		
	Alarm logs	Yes		
	Real-time clock	Built-in		
	Discrete I/O	–	1 input (reset) and 3 outputs (alarm, buzzer, run)	
Multimedia I/O	–	1 audio input (microphone), 1 composite video input (digital or analog video camera), 1 audio output (loudspeaker) (1)		
<b>Communication</b>	Downloadable protocols	Uni-TE™ (2), Modbus®, Modbus® TCP/IP (1) and for PLC brands: Mitsubishi, Omron, Allen-Bradley and Siemens		
	Asynchronous serial link	RS 232C/485 (COM1)	RS 232C/RS 422/485 (COM1) and RS 485 (COM2)	
	USB ports	1	1	2
	Bus and networks	–	Modbus Plus™ and Fipway® with USB gateway, Profibus DP™ and Device Net with optional card	
		Ethernet TCP/IP (10BASE-T/100BASE-TX) (1)		
	Printer link	USB port for parallel printer	RS 232C (COM1) serial link, USB port for parallel printer	
<b>Design software</b>		Vijeo Designer™ (36349/11) (on Windows 2000®, Windows XP® and Vista®)		
<b>Operating system</b>		Magelis® (100 MHz RISC CPU) or (200 MHz RISC CPU)	Magelis (133 MHz RISC CPU)	Magelis (266 MHz RISC CPU)
<b>Terminal model</b>		<b>XBT GT11/13</b>	<b>XBT GT21/22/23</b>	<b>XBT GT42/43</b>
<b>Pages</b>		Consult our catalog "Human/Machine Interfaces" (1) Depending on model (2) Uni-TE™ version V2 for Twido controller and TSX Micro/Premium platform.		





Touch screen Advanced panels - XBT GT			Advanced panels with keypad/ touch screen - XBT GK		Touch screen/open Advanced panels - XBT GTW	
---------------------------------------	--	--	---	--	--	--



Backlit color STN LCD or color TFT LCD (640 x 480 pixels)	Backlit color TFT LCD (800 x 600 pixels)	Backlit color TFT LCD (1024 x 768 pixels)	Color TFT LCD (320 x 240 pixels) or monochrome STN	Color TFT LCD (640 x 480 pixels)	Color TFT LCD (800 x 600 pixels)	Color TFT LCD (1024 x 768 pixels)
10.4" (color)	12.1" (color)	15" (color)	5.7" (monochrome or color)	10.4" (color)	8.4" (color)	15" (color)

Via touch screen	Via keypad and/or touch screen (configurable) and/or by industrial pointer		Via touch screen
-	10	12	-
-	14	18	-
-	8	-	-
-	12	-	-

32 MB Flash EPROM	16 MB Flash EPROM	32 MB Flash EPROM	Limited by 1 GB CF system
By 128, 256, 512 MB or 1 GB CF card			

Limited by the internal Flash EPROM memory capacity or CF card memory capacity

Unlimited (8000 variables max.)

Alphanumeric, bitmap, bargraph, gauge, tank, tank level indicator, curves, polygon, button, light

32 groups of 64 recipes comprising 1024 ingredients max.

Yes, with log

Yes

Built-in

1 input (reset) and 3 outputs (alarm, buzzer, run)	-	1 input - 3 outputs	-
--	---	---------------------	---

1 audio input (microphone), 1 composite video input (digital or analog video camera), 1 audio output (loudspeaker) (1)	-	1 audio output
--	---	----------------

Uni-TE™ (2), Modbus®, Modbus® TCP/IP (1) and for PLC brands: Mitsubishi, Omron, Allen-Bradley and Siemens

RS 232C/RS 422/485 (COM1) and RS 485 (COM2)	RS 232C/RS 422/485 (COM1) RS 485 (COM2)	RS 232C (COM1) RS 232C (COM2)
2	1	4

Modbus Plus™ and Fipway® with USB gateway, Profibus DP™ and Device Net with optional card	4 + 1 on front
---	----------------

Ethernet TCP/IP (10BASE-T/100BASE-TX)	Modbus Plus with USB gateway
---------------------------------------	------------------------------

1 Ethernet TCP/IP port (10BASE-T/100BASE-TX) and 1 Ethernet port (10BASE-T/100BASE-TX/1 GB)
---

RS 232C (COM1) serial link, USB port for parallel printer

Vijeo Designer™ (36349/11) (on Windows 2000 and Windows XP)	Vijeo Designer™ (36349/11) (Windows 2000®, Windows XP® and Vista®)
---	--

Magelis® (266 MHz RISC CPU)	Windows XP embedded
-----------------------------	---------------------

<b>XBT GT52/53</b>	<b>XBT GT63</b>	<b>XBT GT73</b>	<b>XBT GK 21/23</b>	<b>XBT GK 53</b>	<b>XBT GTW 450</b>	<b>XBT GTW 750</b>
--------------------	-----------------	-----------------	---------------------	------------------	--------------------	--------------------

Consult our catalog "Human/Machine Interfaces"	Consult our catalog "Human/Machine Interfaces"
--	--



**Applications**

Traditional architecture, HMI executed on PC platform or dedicated terminal  
Configuration software for operator dialog applications



<b>Target products</b>	Type
	Operating system on terminals

Magelis® XBT N (1)  
Magelis® XBT R/RT (1)

Proprietary Magelis®

<b>Functions</b>	Reading/writing of PLC variables
	Display of variables
	Data processing
	Sharing of variables between HMI applications
	Saving of variables to external database

Yes

Yes

–

–

–

<b>Development of graphics applications</b>	Native library of graphic objects	
	Container	Active X
		Java® Beans
	Curves and alarms	
	Scripts	

Yes

–

–

Yes (2)

–

**Online modification of applications**

–

**Communication between PLCs and HMI application**

Via I/O drivers

**Uploading of applications**

Yes

**Simulation of HMI applications**

Yes

**Redundancy**

–

**Recipe management**

–

**Report printing**

–

**Access security**

Linked to user profiles

**Software compatible with OS**

Windows 2000®, Windows XP® or Windows Vista®

**Type of software**

**Vijeo Designer™ Lite**



**Pages**

Consult our catalog "Human/Machine Interfaces"

(1) Magelis XBT terminals behave transparently on restoration of power.

(2) Depending on model

**Traditional architecture, HMI executed on PC platform or dedicated terminal  
Configuration software for operator dialog applications**



Magelis® XBT G (1)  
Magelis XBT GT (1)  
Magelis XBT GK (1)  
Magelis XBT GTW (1)

Except Magelis XBT GTW: Windows XP® embedded

Yes

Yes

Yes, using expression editor or Java programming

–

–

Yes

–

Yes

Yes, with log

Java®

–

Via I/O drivers

Yes

Yes

–

Yes

Real-time alarms, log data

Linked to user profiles

Windows XP or Windows Vista

**Vijeo Designer™**



Consult our catalog "Human/Machine Interfaces"



# Connection interfaces and power supplies

## 8.1 - Advantys™ Telefast® ABE 7 pre-wired system

<b>Selection guide</b> .....	<b>8/2</b>
■ Presentation .....	8/8
■ References	
□ Passive connection sub-bases for discrete signals .....	8/10
□ Sub-bases with soldered solid state .....	8/12
□ Sub-bases equipped with plug-in relays .....	8/13
□ Sub-bases for analog channels .....	8/16
■ Dimensions .....	8/18

## 8.2 - Power supplies for d.c. control circuits

<b>Selection guide: Phaseo® power supplies</b> .....	<b>8/20</b>
■ Phaseo® Universal range regulated switch mode power supplies	
□ Presentation,description .....	8/24
□ Characteristics .....	8/26
□ References .....	8/31
□ Dimensions and schemes .....	8/32
■ Phaseo® AS-Interface® range power supplies	
□ Presentation .....	8/34
□ Characteristics .....	8/35
□ Functions .....	8/36
□ References .....	8/37
□ Dimensions and schemes .....	8/37

# Modicon® Premium™ automation platform

Advantys™ Telefast® ABE 7 pre-wired system  
Discrete input / output sub-bases

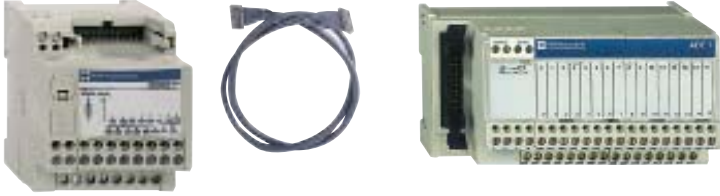
<b>Applications</b>	<b>Discrete inputs or outputs</b>				
	<b>Optimum "Low cost"</b>		<b>Optimum "Miniature"</b>		<b>Universal</b>
					
<b>Relay amplification</b>	-				
<b>Equipped with relay</b>	-				
<b>Control voltage</b>	~ 24V				
<b>Output voltage</b>	~ 24V				
<b>Output current per channel</b>	0.5 A				
<b>Modularity</b>	16		8 -12 -16		
<b>No. of terminals per channel</b>	1	1 to 3		1	2
<b>Type of connection terminals</b>	Signal	Signal, common (configurable ~ 24 V or 0 V)		Signal	Signal, common (configurable ~ 24 V or 0 V)
<b>Connectors</b>	20-way HE10 connector				
<b>Terminal block</b>	<b>Removable</b>	No		No	
	<b>Terminal type</b>	Screw		Screw or spring	
<b>Additional or optional ★ function</b>	Low cost version fitted with cable	Miniature sub-bases	Compact size ★	Type 2 input ★ (2)	Isolator ★
<b>Device type</b>	<b>ABE 7H20E●00</b> <b>ABE 7H34E●00 (1)</b>		<b>ABE 7H16C●●</b>	<b>ABE 7H●●R1●</b> <b>ABE 7H●●R50</b>	<b>ABE 7H●●R2●</b> <b>ABE 7H●●S21</b>
<b>Pages</b>	8/10		8/11		
	(1) <b>ABE 7H34E●00</b> sub-bases for Modicon® M340™ PLCs. (2) For Modicon® TSX Micro™ and Modicon® Premium™ PLCs				

**Discrete inputs and outputs**

**Optimum "Miniature"**

**Optimum**



-		Plug-in electromechanical or solid state	
-		No	Yes
≡ 24V			
≡ 24V		≡ 24V (solid state) ≡ 5... 24V, ~ 230 V (electromechanical)	
0.5 A	0.5 A	5 A (E.M.), 2 A (solid state)	5 A (th)
16		16 8 passive inputs 8 relay outputs	
1	2	1	
Signal, 2 common connections between the inputs and the outputs.	Signal, common, 2 common connections between the inputs and the outputs.	1 N/O contact and common, 4 output channels 2 input connection points	
20-way HE10 connectors			
No			
Screw			
Miniature sub-base Synergy with Tego® Power and Micro™ PLC		Miniature sub-base - Common per 4 channels Synergy with Tego Power and Micro PLC	
<b>ABE 7H16CM11</b>	<b>ABE 7H16CM21</b>	<b>ABE 7P16M111</b>	<b>ABE 7R16M111</b>
8/10		8/14	8/13

# Modicon® Premium™ automation platform

Advantys™ Telefast® ABE 7 pre-wired system  
Discrete input / output sub-bases

Applications	Discrete output				
	“Optimum”		“Universal”		“Optimum”
					
Relay amplification	Electromechanical, fixed			Electromechanical or solid state	
Equipped with relay	Yes			Yes	No
Control voltage	~ 24 V				
Output voltage	~ 5 V... 30 V ~ 230 V		~ 5 V... 150 V ~ 230 V		~ 24 V (solid state) ~ 5 V... 24 V, ~ 230 V (E.M.)
Output current per channel	2 A (th)	3 A (th)	5 A (th)	2 A (solid state), 6 A (electromechanical)	Depends on relay mounted 0.5 to 10 A
Modularity	8	8 - 16		16	8 or 16
No. of terminals per channel	2	1	2	1	2 to 3
Type of connection terminals	1 N/O contact and common Volt-free	1 N/O contact	1 N/O contact and common	1 N/O contact	Signal, Polarities
Connectors	20-way HE 10 connector				
Terminal block	Removable				
	Terminal type	Yes	Yes	Yes	No
		Screw or spring			Screw
Additional or optional* function	Miniature sub-base Latching relay	Volt-free or common per 8 channels		Miniature sub-bases Common per 4 channels	Isolator and fuse
Device type	ABE 7R08S216●	ABE 7R●●S1●●	ABE 7R●●S2●●	ABE 7R16T111	ABE 7P16T111
					ABE 7P16T2●●● ABE 7P08T3●●●
Pages	8/12			8/13	8/14



Discrete outputs				Discrete inputs			
“Universal”				“Universal”			



Electromechanical, plug-in		Solid state, fixed		–	–	Solid state, fixed		Solid state, plug-in	
Yes		Yes		–	–	Yes		No	
⎓ 24 V						From ⎓ 24 V to ~ 230 V		From 5 V TTL to ~ 230 V	
⎓ 5 V... 150 V ~ 230 V		⎓ 24 V							
5A (th)	8 A (th)	from 0.5 to 2 A	125 mA	0.5 A	125 mA	12 mA			
16									
2 to 3	2 to 6	2		3	2				
1 C/O contact or 1 N/O contact and common	1 C/O contact or 2 C/O contacts and common	Signal and 0 V		Signal ⎓ 24 V and 0 V	Signal can be isolated, Protected common		Signal	Signal and common	
20-way HE 10 connector									
No		Yes	No	No		Yes	No		
Screw		Screw or spring		Screw		Screw or spring			
Volt-free or common per:		Detected fault signal	Isolator and fuse (indicator)	3-wire proximity sensor	Isolator and fuse (indicator)	–			
8 channels	4 channels								
<b>ABE 7R16T2●●</b>	<b>ABE 7R16T3●●</b>	<b>ABE 7S●●S2B●</b>	<b>ABE 7H16F43</b>	<b>ABE 7H16R3●</b>	<b>ABE 7H16S43</b>	<b>ABE 7S16E2●●</b>	<b>ABE 7P16F31●</b>		
8/13		8/12	8/11		8/12		8/15		

# Modicon® Premium™ automation platform

Advantys™ Telefast® ABE 7 pre-wired system  
Analog / Application-specific sub-bases

**Applications**

**Analog signals and special functions**



**Compatibility**

Modicon® TSX Micro™	Modicon® Premium™		Standard	Modicon® M340™ BMX ART 0414 / 0814 BMX AMI 0410
---------------------	-------------------	--	----------	---

**Type of signal**

Counter inputs and analog I/O	Counter inputs Axis control Position control	Analog inputs Current Voltage Pt 100	Analog outputs Current Voltage	Analog inputs
-------------------------------	--	---	--------------------------------------	---------------

**Functions**

Passive connection, point-to-point with shield continuity	Direct connection Cold-junction compensation or distributed 4 protected isolated power supplies
---	--

**Modularity**

1 counter channel or 8 analog inputs + 2 analog outputs	8 channels	4 channels	4 channels
---	------------	------------	------------

**Control voltage**

≡ 24 V	–
--------	---

**Output voltage**

≡ 24 V	–
--------	---

**Output current per channel**

25 mA	–
-------	---

**No. of terminals per channel**

2	2 or 4	2 or 4	2 or 4
---	--------	--------	--------

**Connector type**

15-way SUB-D + 9-way SUB-D	25-way SUB-D	25-way SUB-D
----------------------------	--------------	--------------

<b>Terminal block</b>	Removable	No	No	No
	Terminal type	Screw	Screw	Screw

**Device type**

<b>ABE 7CPA01</b>	<b>ABE 7CPA02</b>	<b>ABE 7CPA21</b>	<b>ABE 7CPA412/410</b>
-------------------	-------------------	-------------------	------------------------

**Pages**

8/16
------

**Analog signals and special functions**



Standard	Modicon® Premium™ TSXAEY810	Premium™ TSX CAY●1 TSX CTY2C	Premium™ TSXAEY1614	Premium™ TSX PAY2●2
Analog inputs Current Voltage Pt 100	Isolated analog inputs	Inputs Counter	Inputs for thermocouples	Inputs/outputs
Distribution of sensor power supplies per limiter (25 mA)	Distribution of isolated sensor power supplies per converter	Acquisition of value from an absolute encoder	Connection of 16 thermocouples with cold junction compensation	Safety module (BG)
8 channels	8 channels	1 channel	16 channels	12 Emergency stops
⎓ 24 V				
⎓ 24 V				
25 mA				–
2 or 4		–	2 or 4	1
25-way SUB-D	25-way SUB-D	15-way SUB-D	25-way SUB-D	50-way SUB-D
No	No	No	No	No
Screw	Screw or spring	Screw	Screw	Screw

<b>ABE 7CPA03</b>	<b>ABE 7CPA31●</b>	<b>ABE 7CPA11</b>	<b>ABE 7CPA12</b>	<b>ABE 7CPA13</b>
-------------------	--------------------	-------------------	-------------------	-------------------

8/16

# Modicon® Premium™ automation platform

## Connection interfaces

### Advantys™ Telefast® ABE 7 pre-wired system

#### Premium connection cables

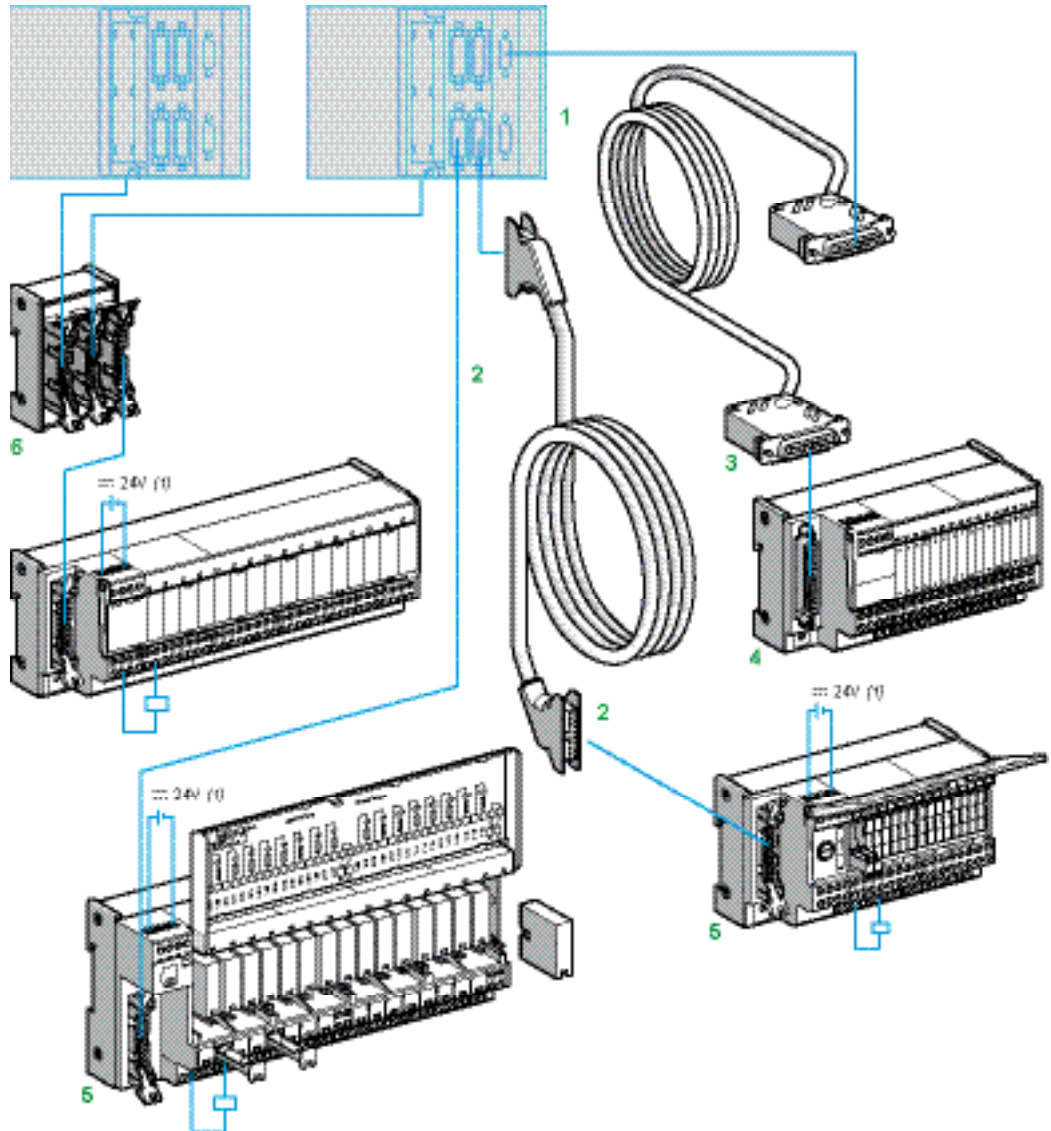

- 1 I/O modules equipped with HE 10 connectors. The modular sizes available are 16, 32 and 64 I/O.
- 2 A single type of cable equipped with 20-way HE 10 connectors, irrespective of the 8, 12 or 16-channel modularity. The HE 10 connectors may be moulded, **TSX™ CDP●●●** (AWG 22) or insulation piercing, **ABF H20H●●●** (AWG 28).  
These cables are available in 0.5, 1, 2, 3 and 5 meter lengths. AWG 28 gauge (0.08 mm<sup>2</sup>) enables 100 mA input and output sub-bases to be connected directly, as well as sub-bases equipped with relays.  
The **ABE 7ACC02** splitter sub-base is used to connect 8-channel sub-bases.
- 3 Analog signal connections are made using a **TSX™ CAP030** pre-wired cable fitted with 25-way SUB-D connectors help to ensure the continuity of the shielding.
- 4 There are several types of sub-bases for counter and analog channels:
  - **ABE 7CPA02** for connecting current, voltage or PT100 inputs to screw terminal blocks,
  - **ABE 7CPA03** with 4-20 mA sensor loop supply and 25 mA limiter for each channel,
  - **ABE 7CPA21** for connecting 4-channel analog output modules to screw terminal blocks,
  - **ABE 7CPA31** with isolated 4-20 mA sensor loop supply for 8 individually isolated input channels,
  - **ABE 7CPA11** for connecting an absolute encoder with parallel outputs,
  - **ABE 7CPA12** for connecting 16 thermocouple probes.
- 5 16-channel Advantys™ Telefast® ABE 7 sub-bases.
- 6 Splitter sub-bases for the parallel connection of discrete I/O from a Advantys Telefast ABE 7 sub-base to 2 different PLCs:
  - **ABE 7ACC10** for output redundancy,
  - **ABE 7ACC11** for input redundancy.

(1) The  $\approx 24\text{ V}$  power supply is connected using Telefast 2 sub-bases only. The  $\approx 0\text{ V}$  connections must be equipotential.

I/O modules for Modicon® Premium™ PLCs																		
--- 24 V discrete																		
Analog																		
Axis control																		
Counter																		
Fast counter																		
Safety																		
Inputs																		
Outputs																		
Thermo-coup. inputs																		
Speed reference																		
Aux. inputs																		
Aux. inputs																		
Counter																		
Aux. inputs																		
Counter																		
4 x 16I	2 x 16I	1 x 16I	4 x 16O	1 x 16I	1 x 12O	2 x 8I	8 I	4 I	4 O	8 O	2 x 8I							
<b>With modules</b>	<b>TSX</b>	DEY 64 D2K 32 D2K	DEY 32 DK	DEY 16 FK	DSY 64 TK 32 TK	DMY 28 FK 28 RFK	AEY 1600	AEY 800	AEY 810	AEY 420	ASY 410	ASY 800	AEY 1614	CAY●1/ CFY●A	CTY●A	CTY2C	PAY 2●2	
<b>Cables with connectors</b>	<b>TSX ABF</b>	CDP●●3 H20H●●0				CAP030				–	CAP030 3			CDP●●3	CAP 030	CDP ●●3	CAP 030	CPP ●●2
<b>Cabled connector with terminal block supplied</b>		–								(5)	–							

Connection sub-bases																		
8 channels	ABE 7H08R●●	(1)		(1)	(1)	(1)										H08 R10 (2)		
	ABE 7H08S21	(1)		(1)	(1)	(1)												
12 channels	ABE 7H12R●●																	
	ABE 7H12S21																	
16 channels	ABE 7H16R●●		H16 R20													H16 R20 (4)	H16 R20 (4)	H16 R20 (4)
	ABE 7H16C●●/ H20E●● (3)																	
	ABE 7H16S21																	
	ABE 7H16R23																	
	ABE 7H16F43																	
	ABE 7H16S43																	
Input adapter sub-bases																		
16 channels	ABE 7S16E2●●																	
	ABE 7P16F3●●																	
Output adapter sub-base																		
8 channels	ABE 7S08S2●●/ ABE 7R08S●●●				(1)													
	ABE 7P08T330				(1)													
16 channels	ABE 7S16S●●●																	
	ABE 7R16S●●●																	
	ABE 7R16T●●●																	
	ABE 7P16T●●●																	
Sub-bases for analog/counter modules																		
	ABE 7CPA01																	
	ABE 7CPA11												(6)					
	ABE 7CPA02																	
	ABE 7CPA21																	
	ABE 7CPA03																	
	ABE 7CPA31																	
	ABE 7CPA12																	
	ABE 7CPA13																	

(1) Using splitter sub-base **ABE 7ACC02** allows 16 channels to be split into 2 x 8 channels.  
 (2) 1-channel connection.  
 (3) **ABE 7H20E●●●** low cost sub-base supplied with cordset  
 (4) 2-channel connection.  
 (5) **ABF Y25S200** cabled connector fitted with a **TSX™ BLY 01** terminal block.  
 (6) Can only be used with module **TSX™ CAY●1**.  
 (7) Only the first 4 channels are used.

 Pre-wired cables

# Modicon® Premium™ automation platform

## Connection interfaces

Advantys™ Telefast® ABE 7 pre-wired system

Passive connection sub-bases

### Passive connection sub-base for discrete inputs/outputs

#### Optimum "Low cost" sub-bases

Function	No. of channels	No. of terminals per channel	For PLCs on row number		Length of PLC connection cable	Type of connection	Reference	Weight kg
Input or output	16	1	2	Modicon® TSX Micro™	1 m	Screw	<b>ABE 7H20E100</b>	0.330
				Modicon® Premium™	2 m	Screw	<b>ABE 7H20E200</b>	0.410
					3 m	Screw	<b>ABE 7H20E300</b>	0.480
				Modicon® M340™	1 m	Screw	<b>ABE 7H34E100</b>	0.330
					2 m	Screw	<b>ABE 7H34E200</b>	0.410
					3 m	Screw	<b>ABE 7H34E300</b>	0.480
				Siemens S7	1.5 m	Screw	<b>ABE 7H32E150</b>	0.360
					3 m	Screw	<b>ABE 7H32E300</b>	0.460



ABE 7H20E●●●

#### Optimum "Miniature" sub-bases

Function	No. of channels	No. of terminals per channel	LED per channel	Polarity distribution	Type of connection	Reference	Weight kg		
Input or output	16	1	1	No	No	Screw	<b>ABE 7H16C10</b>	0.160	
				Yes	No	Screw	<b>ABE 7H16C11</b>	0.160	
		2	2	Yes	0 or 24 V	Screw	<b>ABE 7H16C21</b>	0.205	
		3	3	Yes	0 or 24 V	Screw	<b>ABE 7H16C31</b>	0.260	
	Input and output (1)	16	1	1	Yes	No	Screw	<b>ABE 7H16CM11</b>	0.160
					Yes	0 or 24 V	Screw	<b>ABE 7H16CM21</b>	0.200



ABE 7H16C21



ABE 7H16CM21

(1) 8 I + 8 O: these products have 2 commons connections which help to enable inputs and outputs to be connected to the same sub-base at the same time.

# Modicon® Premium™ automation platform

## Connection interfaces

### Advantys™ Telefast® ABE 7 pre-wired system

#### Passive connection sub-bases



ABE 7H16R50



ABE 7H16R31

Passive connection sub-base for discrete signals (continued)											
Universal sub-bases											
Function	No. of channels	No. of terminals per channel	No. of terminals on row	LED per channel	Polarity distribution	Isolator (I) Fuse (F) per channel	Type of connection	Reference	Weight		
									kg		
Input or output	8	1	1	No	No	–	Screw	ABE 7H08R10	0.187		
				Yes	No	–	Screw	ABE 7H08R11	0.187		
		2	2	2	Yes	0 or 24 V	–	Screw	ABE 7H08R21	0.218	
							I	Screw	ABE 7H08S21	0.245	
		12	1	1	1	No	No	–	Screw	ABE 7H12R10	0.274
						Yes	No	–	Screw	ABE 7H12R11	0.274
	2		2	2	No	No	–	Screw	ABE 7H12R50	0.196	
							I	Screw	ABE 7H12S21	0.375	
	2		2	2	No	0 or 24 V	–	Screw	ABE 7H12R20	0.300	
							Yes	0 or 24 V	–	Screw	ABE 7H12R21
	16	1	1	1	No	No	–	Screw	ABE 7H16R10	0.274	
					Yes	No	–	Screw	ABE 7H16R11	0.274	
2			2	2	No	No	–	Screw	ABE 7H16R50	0.196	
							I	Screw	ABE 7H16S21	0.375	
2			2	2	No	0 or 24 V	–	Screw	ABE 7H16R20	0.300	
							Yes	0 or 24 V	–	Screw	ABE 7H16R21
3		2	2	2	Yes	0 or 24 V	–	Screw	ABE 7H16R23	0.320	
							I, F (2)	Screw	ABE 7H16S43	0.640	
		2	2	2	Yes	0 V	I, F (2)	Screw	ABE 7H16F43	0.640	

(1) For Modicon® Premium™.

(2) With LED to indicate blown fuse.

# Modicon® Premium™ automation platform

## Connection interfaces

Advantys™ Telefast® ABE 7 pre-wired system

Discrete I/O sub-bases: relays / terminal blocks

### Adaptation sub-bases with soldered relays, removable terminal blocks

#### Input Universal sub-bases with solid state relays

No. of channels	No. of terminals per channel	Isolation PLC/Operative part	Voltage	Type of connection	Reference	Weight kg
16	2	Yes	≡ 24 V	Screw	ABE 7S16E2B1	0.370
				Spring	ABE 7S16E2B1E	0.370
			≡ 48 V	Screw	ABE 7S16E2E1	0.370
				Spring	ABE 7S16E2E1E	0.370
			~ 48 V	Screw	ABE 7S16E2E0	0.386
				Spring	ABE 7S16E2E0E	0.386
			~ 110 V	Screw	ABE 7S16E2F0	0.397
				Spring	ABE 7S16E2F0E	0.397
			~ 230 V	Screw	ABE 7S16E2M0	0.407
				Spring	ABE 7S16E2M0E	0.407

#### Output Universal sub-bases with solid state relays

No. of channels	Isolation PLC/Operative part	Output voltage	Output current	Fault detection signal (1)	Type of connection	Reference	Weight kg
8	No	≡ 24 V	0.5 A	Yes (2)	Screw	ABE 7S08S2B0	0.252
					Spring	ABE 7S08S2B0E	0.252
			2 A	Yes (2)	Screw	ABE 7S08S2B1	0.448
					Spring	ABE 7S08S2B1E	0.448
16	No	≡ 24 V	0.5 A	Yes (2)	Screw	ABE 7S16S2B0	0.405
					Spring	ABE 7S16S2B0E	0.405
			Non		Screw	ABE 7S16S1B2	0.400
					Spring	ABE 7S16S1B2E	0.400

#### Output Optimum & Universal sub-bases with electromechanical relays

No. of channels	Relay width	Number of contacts	Output current	Polarity distribution/operative part	Type of connection	Reference	Weight kg
8	5 mm	1 N/O	2 A	Contact common per group of 4 channels	Screw	ABE 7R08S111	0.252
					Spring	ABE 7R08S111E	0.252
		Latching	2 A	Volt-free	Screw	ABE 7R08S216	0.448
	Spring				ABE 7R08S216E	0.448	
	10 mm	1 N/O	5 A	Volt-free	Screw	ABE 7R08S210	0.448
					Spring	ABE 7R08S210E	0.448
16	5 mm	1 N/O	2 A	Contact common per group of 8 channels	Screw	ABE 7R16S111	0.405
					Spring	ABE 7R16S111E	0.405
		10 mm	1 N/O	5 A	Volt-free	Screw	ABE 7R16S210
	Spring					ABE 7R16S210E	0.405
	Common per group of 8 channels on both poles				Screw	ABE 7R16S212	0.400
					Spring	ABE 7R16S212E	0.400

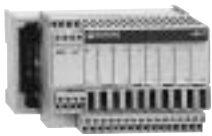

ABE 7R08S216

(1) A detected fault on a sub-base output Qn will set PLC output Qn to safety mode, which will be detected by the PLC.

(2) Can only be used with modules with protected outputs.



# Modicon® Premium™ automation platform

## Connection interfaces

Advantys™ Telefast® ABE 7 pre-wired system

Discrete I/O adaptation sub-bases for / with plug-in relays

### Adaptation sub-bases, for plug-in relays

#### Input Universal sub-bases for solid state relays (1)

No. of channels	No. of terminals per channel	For relay type	Isolation PLC/Operative part	Input connection	Type of connection	Reference	Weight kg
16	2	ABS 7E	Yes	Volt-free	Screw	<b>ABE 7P16F310</b>	0.850
		ABR 7			Spring	<b>ABE 7P16F310E</b>	0.850
		ABS 7S33E			Polarity distribution	Screw	<b>ABE 7P16F312</b>



ABE 7R16M111

#### Output Optimum & Universal sub-bases with electromechanical relays (2)

No. of channels	Relay width	For relay type	No. and type of contacts	Polarity distribution/operative part	Reference	Weight kg
16	5 mm	ABR 7S11	1 N/O	Contact common per group of 4 channels	<b>ABE 7R16T111</b>	0.600
				Contact common per group of 4 output channels + 2 input common terminals	<b>ABE 7R16M111</b> (3)	0.600
				Volt-free	<b>ABE 7R16T210</b>	0.735
	10 mm	ABR 7S21	1 N/O	Common on both poles (4)	<b>ABE 7R16T212</b>	0.730
				Volt-free	<b>ABE 7R16T230</b>	0.775
	12 mm	ABR 7S33	1 C/O	Contact common (4)	<b>ABE 7R16T231</b>	0.730
Common on both poles (5)				<b>ABE 7R16T330</b>	1.300	
		ABR 7S37	2 C/O	Volt-free	<b>ABE 7R16T370</b>	1.300



ABE 7R16T210

(1) Not equipped with relays.

(2) Both technologies (electromechanical and solid state) may be combined on the same sub-base.

(3) 2 connection methods are available, enabling inputs and outputs to be connected to the same sub-base at the same time.

(4) Per group of 8 channels.

(5) Per group of 4 channels.

# Modicon® Premium™ automation platform

## Connection interfaces

Advantys™ Telefast® ABE 7 pre-wired system

Discrete output adaptation sub-bases for plug-in relays

Adaptation sub-bases for plug-in relays (1)										
Output Optimum & Universal sub-bases for solid state and/or with electromechanical relays (2)										
No. of Relay channels	Relay width	For relay type	Isolator per channel	Fuse per channel	Polarity distribution/operative part	Type of connection	Reference	Weight kg		
16	5 mm	ABR 7S11 ABS 7SC1B	No	No	Contact common per group of 4 channels		ABE 7P16T111	0.550		
							ABE 7P16M111 (2)	0.550		
	10 mm	ABR 7S2● ABS 7SA2● ABS 7SC2● ABE 7ACC20	No	No	Volt-free	Screw	ABE 7P16T210 (3)	0.615		
							ABE 7P16T230 (3)	0.655		
						Spring	ABE 7P16T230E (3)	0.655		
						Yes	Volt-free	Screw	ABE 7P16T214	0.675
						No	Common on both poles (4)	Screw	ABE 7P16T212	0.615
	Yes	Common on both poles (4)	Screw	ABE 7P16T215	0.670					
	8	12 mm	ABR 7S33 ABS 7A3● ABS 7SC3●● ABE 7ACC21	No	No	Volt-free	Screw	ABE 7P08T330	0.450	
Spring							ABE 7P08T330E	0.450		
16	12 mm	ABR 7S33 ABS 7A3● ABS 7SC3●● ABE 7ACC21	No	No	Volt-free	Screw	ABE 7P16T330	0.900		
						Spring	ABE 7P16T330E	0.900		
							Common on both poles (5)	Screw	ABE 7P16T332	0.900
							ABR 7S33 ABS 7A3M ABS 7SC3E ABE 7ACC21	Screw	ABE 7P16T334	0.900
						Yes	Yes	Common on both poles (5)	Screw	ABE 7P16T318
		Spring	ABE 7P16T318E	1.000						



ABE 7P16T210●●

(1) Not equipped with relays.  
 (2) 2 connection methods are available, enabling inputs and outputs to be connected to the same sub-base at the same time.  
 (3) With relay ABR 7S21 for sub-base ABE 7P16T210, with relay ABR 7S23 for sub-base ABE 7P16T230●.  
 (4) Per group of 8 channels.  
 (5) Per group of 4 channels.

# Modicon® Premium™ automation platform

## Connection interfaces

### Advantys™ Telefast® ABE 7 pre-wired system

#### Plug-in relays

#### Plug-in solid state relays

Relay width	Functions	Input circuit		Output circuit		Unit reference	Weight							
		Current	Nominal voltage	Current (1)	Nominal voltage									
5 mm	Output	---	24 V	2 A	---	24 V	ABS 7SC1B	0.010						
								Sold in lots of 4						
10 mm	Output	---	24 V	0.5 A	---	5...48 V	ABS 7SC2E	0.016						
								~ 24...240 V	ABS 7SA2M	0.016				
12 mm	Input	---	5 V TTL	-	---	24 V	ABS 7EC3AL	0.014						
								24 V	-	---	24 V	ABS 7EC3B2	0.014	
														Type 2
								48 V	-	---	24 V	ABS 7EC3E2	0.014	
														Type 2
								~ 50 Hz	48 V	-	---	24 V	ABS 7EA3E5	0.014
								~ 60 Hz	110...130 V	-	---	24 V	ABS 7EA3F5	0.014
~ 50 Hz	230...240 V	-	---	24 V	ABS 7EA3M5	0.014								
Output	---	24 V	2 A	Self-protected	---	24 V	ABS 7SC3BA	0.016						
								1.5 A	---	5...48 V	ABS 7SC3E	0.016		
													~ 24...240 V	ABS 7SA3MA



ABS 7SC1B

#### Plug-in electromechanical relays

Relay width	Control voltage	Output current (1)	Number of contacts	Sold in lots of	Unit reference	Weight	
5 mm	---	24 V	5 A (lth)	1 N/O	4	ABR 7S11	0.005
10 mm	---	24 V	5 A (lth)	1 N/O	4	ABR 7S21	0.008
				1 C/O	4	ABR 7S23	0.008
12 mm	---	24 V	10 A (lth)	1 C/O	4	ABR 7S33	0.017
			8 A (lth)	2 C/O	4	ABR 7S37	0.017
			8 A (lth)	1 C/O	4	ABR 7S33E	0.017
	---	48 V	8 A (lth)	1 C/O	4	ABR 7S33E	0.017



ABR 7S21



ABR 7S33

#### Accessory

Description	Reference	Weight
Extractor for 5 mm miniature relays	ABE 7ACC12	0.010

(1) See characteristics table for specifications of relays in the sub-bases.

# Modicon® Premium™ automation platform

## Connection interfaces

Advantys™ Telefast® ABE 7 pre-wired system

Connection sub-bases for counter and analog channels



ABE 7CPA01



ABE 7CPA412/410/21



ABE 7CPA02

Connection sub-bases for counter and analog channels						
Functions	For Modicon® PLCs	Compatible modules	Type of connection Telefast® 2 side	Type of connection	Reference	Weight kg
Counting and analog	TSX Micro™	Integrated analog and counter TSX™ 37 22 TSX™ CTZ●A	15-way SUB-D	Screw	<b>ABE 7CPA01</b>	0.300
Counting, Axis control, Position control	Premium™	TSX™ CTY●A TSX™ CAY●1	15-way SUB-D	Screw	<b>ABE 7CPA01</b>	0.300
Parallel output absolute encoder connection	Premium	TSX CTY●A TSX CAY●1	15-way SUB-D	Screw	<b>ABE 7CPA11</b>	0.330
Distribution of 4 thermocouples	Modicon® M340™	BMX ART 0414 BMX ART 0814	25-way SUB-D	Screw	<b>ABE 7CPA412</b>	0.180
Distribution of 16 thermocouples	Premium	TSX™ AEY1614	25-way SUB-D	Screw	<b>ABE 7CPA12</b>	0.300
Passive distribution of 8 channels on screw terminal block with shielding continuity	Premium	TSX™ ASY810 TSX™ AEY1600 TSX™ A●Y800	25-way SUB-D	Screw	<b>ABE 7CPA02</b>	0.290
Distribution and supply of 4 analog channels protected isolated	Modicon M340	BMX AMI 0410	25-way SUB-D	Screw	<b>ABE 7CPA410</b>	0.180
Distribution of 4 analog output channels	Premium	TSX ASY410 TSX AEY420	25-way SUB-D	Screw	<b>ABE 7CPA21</b>	0.180
Distribution and supply of 8 analog input channels with limitation of each current loop	Premium	TSX AEY800 TSX AEY1600	25-way SUB-D	Screw	<b>ABE 7CPA03</b>	0.330
Distribution and supply of 8 analog input channels isolated from each other with 25 mA/ channel limiter	Premium	TSX AEY810	25-way SUB-D	Screw	<b>ABE 7CPA31</b>	0.410
Safety	Premium	TSX™ PAY2●2	25-way SUB-D	Screw	<b>ABE 7CPA13</b>	0.290

# Modicon® Premium™ automation platform

## Connection interfaces

Advantys™ Telefast® ABE 7 pre-wired system

Accessories for connection sub-bases



ABE 7ACC02

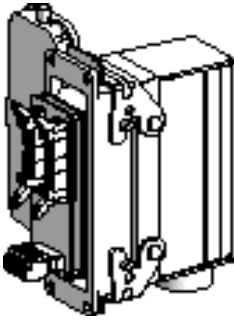

ABE 7ACC80 + ABE 7ACC81



ABE 7BV20

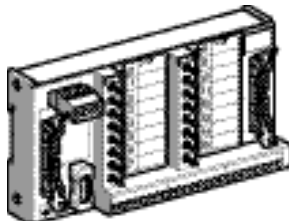

ABE 7TES160

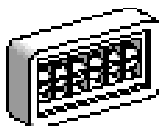

AR1 SB3

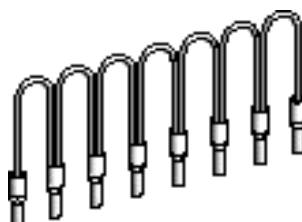

ABE C08R...

### Software

Description	Operating system	Reference	Weight kg
Software for marking customer labels	Under Windows® version 3.1 or 95	ABE 7LOGV10	0.350
Pack of 25 pre-cut label sheets (160 labels)	–	ABE 7LOGF25	0.200

### Accessories

Description	No. of channels	Characteristics	Sold in lots of	Unit reference	Weight kg
Kit for mounting on solid plate	–	–	10	ABE 7ACC01	0.008
Splitter sub-base	–	16 as 2 x 8 channels	1	ABE 7ACC02	0.075
Redundant output sub-base	–	16 as 2 x 16 channels	1	ABE 7ACC10	0.075
Redundant input sub-base	–	16 as 2 x 16 channels	1	ABE 7ACC11	0.075
Plug-in continuity blocks	–	Width 10 mm	4	ABE 7ACC20	0.007
		Width 12 mm	4	ABE 7ACC21	0.010
Locating device for removable terminal block	–	–	100	ABE 7ACC30	0.100
Enclosure feedthrough with industrial connector	32	40-way	1	ABE 7ACC80	0.300
Plug-in 40-way male connector	32	For mounting on ABE 7ACC80	1	ABE 7ACC81	0.370
Enclosure feedthrough with CNOMO M23 connector (1 x 20-way HE 10 connector, PLC end)	16	19-way	1	ABE 7ACC82	0.150
		8 and 12	19-way	1	ABE 7ACC83
Impedance adapter for Type 2 compatibility	–	Used with ABE 7ACC82 and ABE 7ACC83	1	ABE 7ACC85	0.012
IP 65 cable gland	–	For 3 cables	5	ABE 7ACC84	0.300
		10 screw terminals	5	ABE 7BV10	0.030
		10 spring terminals	5	ABE 7BV10E	0.030
		20 screw terminals	5	ABE 7BV20	0.060
Additional snap-on terminal blocks (shunted terminals)	8	10 screw terminals	5	ABE 7BV10	0.030
		10 spring terminals	5	ABE 7BV10E	0.030
	16	20 screw terminals	5	ABE 7BV20	0.060
		20 spring terminals	5	ABE 7BV20E	0.060
I/O simulator sub-base	16	Display, forcing inhibition, continuity	1	ABE 7TES160	0.350
Self-adhesive marker tag holder	–	For 6 characters	50	AR1 SB3	0.001
Quick-blow fuses 5 x 20, 250 V, UL	–	0.125 A	10	ABE 7FU012	0.010
		0.5 A	10	ABE 7FU050	0.010
		1 A	10	ABE 7FU100	0.010
		2 A	10	ABE 7FU200	0.010
		4 A	10	ABE 7FU400	0.010
		6.3 A	10	ABE 7FU630	0.010

### Commoning link accessories

Description	For common	Color	Distance between cable ends	Reference	Weight kg
Commoning links Modularity 8 x 1 mm <sup>2</sup>	Coil	White	12 cm	ABF C08R12W	0.020
			2 cm	ABF C08R02W	0.010
	~	Red	12 cm	ABF C08R12R	0.020
			2 cm	ABF C08R02R	0.010
	---	Blue	12 cm	ABF C08R12B	0.020
			2 cm	ABF C08R02B	0.010

Common side view

ABE 7H20E●●●/34E●●●  
ABE 7H32E●●●

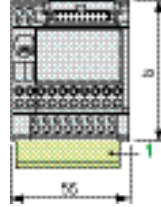
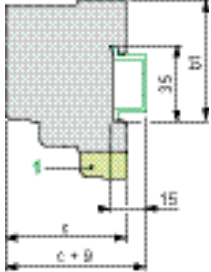

ABE 7H16C●●/ABE 7H16CM●●,  
ABE 7●16M111/ABE 7●16T111

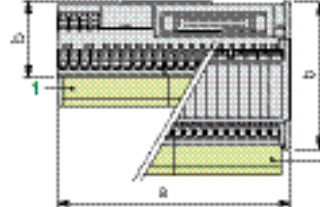

ABE 7H16R50, ABE 7H12R50,  
ABE 7H08R1●, ABE 7H08R21,  
ABE 7R08S111/S111E,  
ABE 7H08S21, ABE 7CPA21/410/412

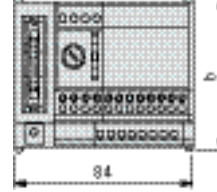

ABE 7H20E/7H32E●●●

b	67
b1	56
c	59

ABE 7H16C●●, 7●16M111,  
7H16CM●● 7●16T111

a	106	110
b	49	89
b1	41.5	58
c	60	54

ABE 7H16/12/08●●● 7R08S111●  
7CPA21/410/412

b	70	77
b1	58	58
c	58	58

1 Additional shunt terminal block ABE 7BV10/7BV20

Common side view

ABE 7H16R2●, ABE 7H12R2●, ABE 7H16R3●,  
ABE 7H16R1●, ABE 7H12R1●, ABE 7H12S21,  
ABE 7H16S2●, ABE 7R16S11●, ABE 7R08S210,  
ABE 7S08S2B0, ABE 7CPA02, ABE 7CPA03  
ABE 7S16S1B2, ABE 7R08S216

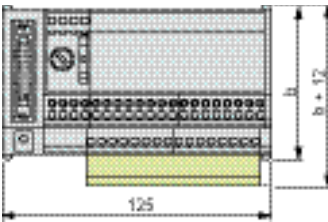
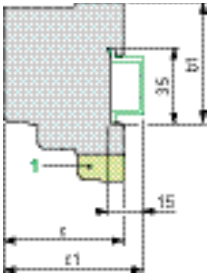

ABE 7R16S21●, ABE 7S16S2B0/S2B02E,  
ABE 7S16E2●●/S16E2●●E,  
ABE 7S08S2B1/S08S2B1E  
ABE 7CPA31

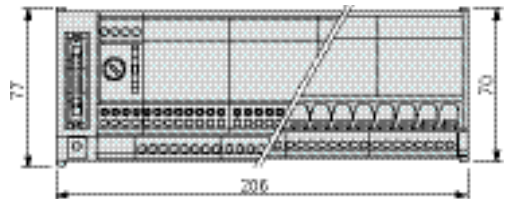

ABE 7●●●●● 7●R08S210●, 7S16S1B2●, 7R08S216

b	70	77
b1	58	58
c	58	58

Sub-bases

b1	58
c	58

1 Additional shunt terminal block ABE 7BV10/7BV20

ABE 7R16T2●●, ABE 7P16T2●●

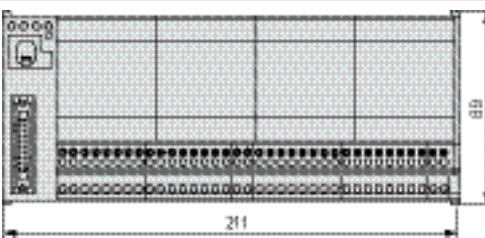
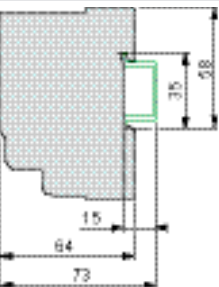

ABE 7CPA01, ABE 7CPA11/CPA12/CPA13

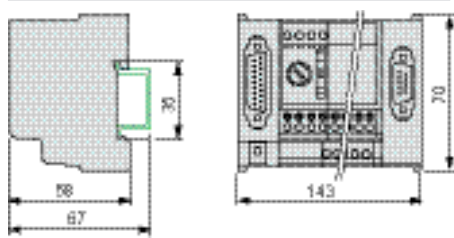

Note : details of the front view are the same as for the ABE 7CPA01.

ABE 7R16T3●●, ABE 7P16T3●●, ABE 7P16F31●

Common side view

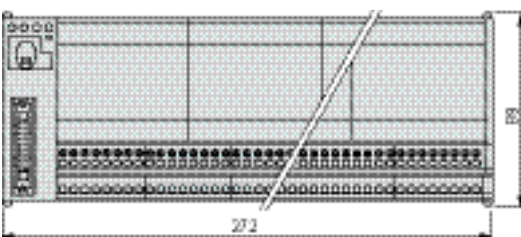
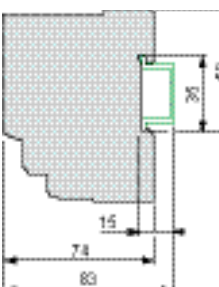

ABE 7P08T330

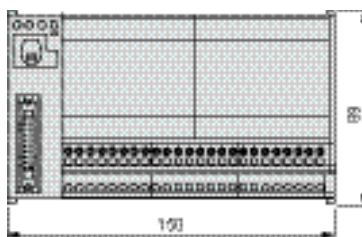

# Modicon® Premium™ automation platform

Connection interfaces

Modicon® Telefast® ABE 7 pre-wired system

ABE 7ACC02

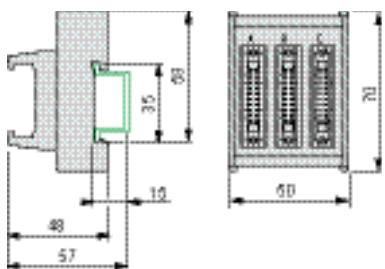

ABE 7ACC03

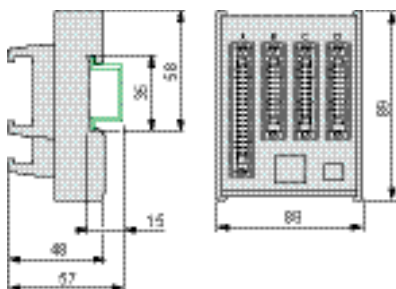

ABE 7ACC04, ABE 7ACC05  
ABE 7ACC10, ABE 7ACC11

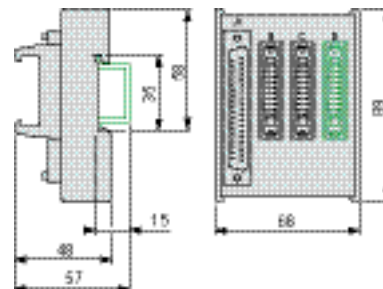

Note : Drawing representing ABE 7ACC04/05

ABE 7ACC80

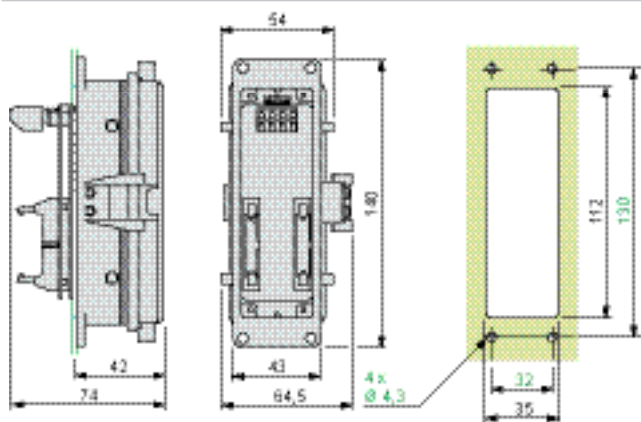

ABE 7ACC82, ABE 7ACC83

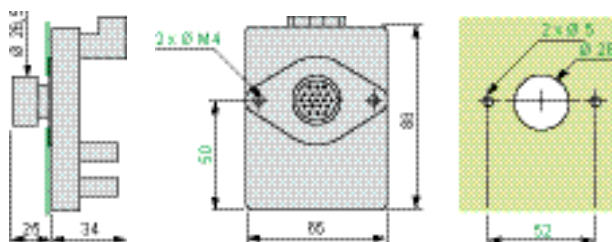

ABE 7ACC84

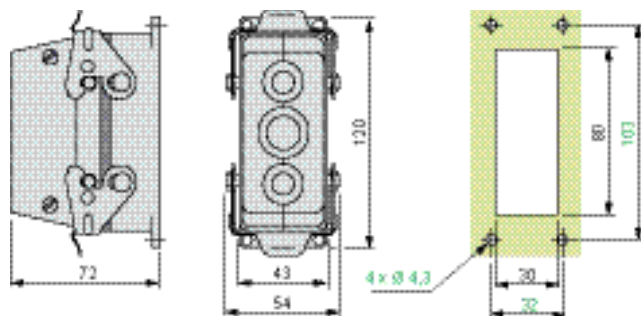

ABE 7TES160

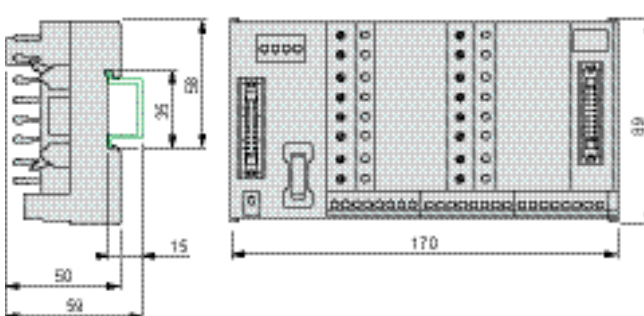

Fixing centers for sub-bases using mounting kit ABE 7ACC01

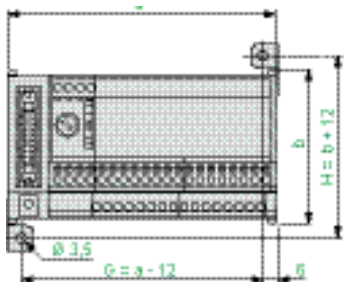

ABE 7	G	H	ABE 7	G	H	ABE 7	G	H
ACC02	38	82	H12R1●	113	82	H16F43	194	82
ACC03	53	101	H12R2●	113	82	H16S43	194	82
ACC04	53	101	H16R1●	113	82	S16E2●●	194	82
ACC05	53	101	H16R2●	113	82	S16S1B2	113	82
ACC10/11	53	101	H16R3●	113	82	S16S2●●	194	82
H08R●●	72	82	H12S21	113	82	R16T2●●	199	101
H08S21	72	82	H16S21	113	82	P16T2●●	199	101
H12R50	72	82	R08S210	113	82	R16T3●●	260	101
H16R50	72	82	R16S111	113	82	P08T330	150	101
R08S111	72	82	R16S21●	194	82	P16T3●●	260	101
CPA01	131	82	S08S2B0	113	82	P16F3●●	260	101
CPA02	113	82	S08S2B1	194	82			
CPA1●	131	82						
CPA03	113	82						

# Modicon® Premium™ automation platform

Power supplies and transformers  
Phaseo® power supplies for DC control circuits

**Power supplies**

**Regulated switch mode**  
Phaseo® Modular range and Optimum range industrial power supplies



<b>Input voltage</b>	
<b>Connection to world-wide line supplies</b>	United States - 120 V (in phase-to-neutral) - 240 V (in phase-to-phase) Europe - 230 V (in phase-to-neutral) - 400 V (in phase-to-phase) United States - 277 V (in phase-to-neutral) - 480 V (in phase-to-phase)

100...240 V ~ 120...250 V ---
Single-phase (N-L1) or 2-phase (L1-L2) connection
Single-phase (N-L1) connection
-

<b>IEC/EN 61000-3-2 conformity</b>	
<b>Protection against undervoltage</b>	
<b>Protection against overloads and short-circuits</b>	
<b>Diagnostic relay</b>	
<b>Compatibility with function modules</b>	
<b>Power reserve (Boost)</b>	

Yes for ABL 7RP, not for ABL 8REM and not applicable for ABL 8MEM and ABL 7RM	
Yes	
Yes, voltage detection. Automatic restart on elimination on the fault	
-	
-	
1,25 to 1,4 In during 1 minute, depending on model (with ABL 8MEM)	No

<b>Output voltage</b>	
<b>Output current</b>	0.3 A 0.6 A 1.2 A 2 A 2.5 A 3 A 4 A 5 A 6 A 10 A 20 A 40 A

5 V ---	12 V ---	24 V ---	48 V ---
		<b>ABL 8MEM24003</b> <i>(Modular)</i>	
		<b>ABL 8MEM24006</b> <i>(Modular)</i>	
		<b>ABL 8MEM24012</b> <i>(Modular)</i>	
	<b>ABL 8MEM12020</b> <i>(Modular)</i>		
		<b>ABL 7RM24025</b> <i>(Modular)</i>	<b>ABL 7RP4803</b> <i>(Optimum)</i>
		<b>ABL 8REM24030</b> <i>(Optimum)</i>	
<b>ABL 8MEM05040</b> <i>(Modular)</i>			
	<b>ABL 7RP1205</b> <i>(Optimum)</i>	<b>ABL 8REM24050</b> <i>(Optimum)</i>	

**Pages**

Consult our catalog "Phaseo Power supplies & transformers"



**Regulated switch mode**  
**Phaseo® Universal range industrial power supplies**



100...120 V ~ and 200...500 V ~ (1)	380...500 V ~	24 V ---	
Single-phase (N-L1) or 2-phase (L1-L2) connection	–	–	
	3-phase (L1-L2-L3) connection	–	
	3-phase (L1-L2-L3) connection	–	
Yes		–	
Yes		–	
Yes, current limitation or undervoltage detection		Yes, current limitation	
Yes, depending on model			
Yes with buffer module, battery and battery control modules, redundancy module and discriminating downstream protection module			
1,5 In during 4 secondes		No	
24 V ---		5 V ---	7...12 V ---
			ABL 8DCC12020 (2)
ABL 8RPS24030			
ABL 8RPS24050			
		ABL 8DCC05060 (2)	
ABL 8RPS24100			
ABL 8RPM24200	ABL 8WPS24200		
	ABL 8WPS24400		

8/31

Consult our catalog "Phaseo Power supplies & transformers"

(1) Except **ABL 8RPM24200**. ~ 100...120 V and ~ 200...240 V.

(2) ---/--- converter module, requires to be associated with the Phaseo Universal range power supply.

# Modicon® Premium™ automation platform

## Power supplies and transformers

### Phaseo® power supplies for DC control circuits

**Power supplies**

**Regulated switch mode**

Phaseo® Dedicated range power supplies for repetitive machines



**Input voltage**

100...240 V ~  
120...370 V ☰

**Connection to world-wide line supplies**

- United States
  - 120 V (in phase-to-neutral)
  - 240 V (in phase-to-phase)
- Europe
  - 230 V (in phase-to-neutral)
  - 400 V (in phase-to-phase)
- United States
  - 277 V (in phase-to-neutral)
  - 480 V (in phase-to-phase)

Single-phase (N-L1) or 2-phase (L1-L2) connection

Single-phase (N-L1)

Single-phase (N-L1)

**IEC/EN 61000-3-2 conformity**

Yes for ABL 1RP, not applicable for ABL1REM24025/12050

**Protection against undervoltage**

-

**Protection against overloads and short-circuits**

Yes, voltage detection. Automatic restart on elimination on the fault

**Diagnostic relay**

-

**Compatibility with function modules**

-

**Power reserve (Boost)**

No

**Output voltage**

12 V ☰

24 V ☰

**Output current** 0.5 A

1 A

2 A

2.5 A

3 A

4 A

4.2 A

4.8 A

5 A

6 A

6.2 A

8.3 A

10 A

15 A

20 A

30 A

40 A

60 A

ABL 1REM24025

ABL 1R•M24042

ABL 1REM12050

ABL 1RPM12083

ABL 1R•M24062

ABL 1R•M24100

**Pages**

Consult our catalog "Phaseo Power supplies & transformers"

**Rectified and filtered**

Phaseo® Rectified range for harsh environment



230 V ~ and 400 V ~

400 V ~

–

Single-phase (N-L1) or 2-phase (L1-L2) connection

3-phase (L1-L2-L3) connection

–

Yes

No

Yes depending on model, by fuse

Yes, by external protection

No

No

No

24 V ---

ABL 8FEQ24005

ABL 8FEQ24010

ABL 8FEQ24020

ABL 8FEQ24040

ABL 8FEQ24060

ABL 8FEQ24100

ABL 8TEQ24100

ABL 8FEQ24150

ABL 8FEQ24200

ABL 8TEQ24200

ABL 8TEQ24300

ABL 8TEQ24400

ABL 8TEQ24600

**Regulated switch mode**

Phaseo® range AS-Interface® for AS-Interface cabling system



100...240 V ~

Single-phase (N-L1) connection

Single-phase (N-L1) connection

–

No

Yes

–

Yes

Yes

–

–

No

30 V ---

24 V ---

ASI ABLB3002  
ASI ABLD3002 (1)  
ASI ABLM3024 (2)

ASI ABLM3024 (2)

ASI ABLB3004  
ASI ABLD3004 (1)

Consult our catalog "Phaseo Power supplies & transformers"

8/37

(1) With ground fault detection.

(2) One output 30 V --- and one output 24 V --- ± 5 %.

# Modicon® Premium™ automation platform

## Power supplies and transformers

### Phaseo® Universal range switch mode power supplies for DC control circuits

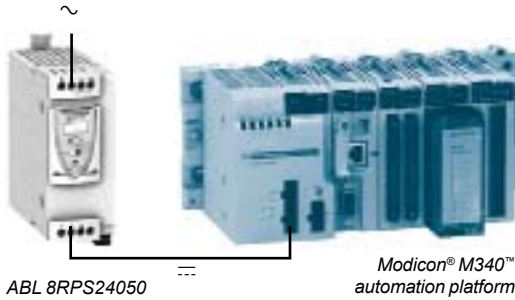

#### Switch mode power supplies: Universal range

The ABL 8RPS/RPM/WPS power supply offer is designed to provide the DC voltage necessary for the control circuits of automation system equipment. Comprising six products, this range meets the needs encountered in industrial and commercial applications. These compact electronic switch mode power supplies provide a quality of output current that is suitable for the loads supplied and compatible with Modicon® Premium™, Quantum™ and M340™ PLCs. When used with additional function modules, they help to ensure continuity of service in the event of network power outages or application malfunctions. Clear guidelines are given on selecting the function modules and upstream protection devices which are often used with them, and thus a comprehensive solution is provided.

The Universal range of Phaseo® power supplies must be connected in phase-to-neutral or phase-to-phase for ABL 8RPS/RPM, and in three-phase for ABL 8WPS. They deliver a voltage that is precise to 3%, whatever the load and whatever the type of line supply, within the ranges:

- 85 to 132 V ~ and 170 to 550 V ~ for ABL 8RPS
- 85 to 132 V ~ and 170 to 264 V ~ for ABL 8RPM
- 340 to 550 V ~ for ABL 8WPS

Their very wide input voltage range allows a considerable reduction of parts held in stock and offers a distinct advantage in terms of machine design.

Conforming to IEC standards and UL and CSA certified, they are suitable for universal use.

ABL 8RPS/RPM and ABL 8WPS power supplies are equipped with a harmonic filter, helping to ensure compliance with standard IEC/EN 61000-3-2 concerning harmonic pollution.

The Universal range of Phaseo® power supplies have protection devices to help ensure optimum performance of the automation system. Their operating mode can be configured as required by the user:

**Manual reset protection mode:** Priority is given to the voltage so as to help maintain the PLC logic states and nominal operation of the supplied actuators.

**Automatic reset protection mode:** Priority is given to the current to allow troubleshooting for example, or to help ensure continuity of service until the arrival of the maintenance team.

The Universal range of Phaseo® power supplies also has a power reserve, allowing them to deliver a current of 1.5 I<sub>n</sub> at regular intervals. This avoids the need to oversize the power supply if the device has a high inrush current, while helping to ensure optimum performance of the automation system.

The diagnostics for the Universal range of Phaseo power supplies are available on the front of the device via LEDs (U<sub>out</sub> and I<sub>out</sub>) and via a volt-free relay contact.

Products are equipped with an output voltage adjustment potentiometer in order to be able to compensate for any line voltage drops in installations with long connection cable runs.

These power supplies are designed for direct mounting on a 35 mm DIN rail.

# Modicon® Premium™ automation platform

Power supplies and transformers

Phaseo® Universal range switch mode power supplies  
for DC control circuits



Modicon® Premium™  
automation platform

## Switch mode power supplies: Universal range (continued)

There are four references available in the Universal range of Phaseo® power supplies for phase-to-neutral or phase-to-phase connection:

ABL 8RPS24030	72 W	3 A	24 V $\overline{\text{---}}$
ABL 8RPS24050	120 W	5 A	24 V $\overline{\text{---}}$
ABL 8RPS24100	240 W	10 A	24 V $\overline{\text{---}}$
ABL 8RPM24200	480 W	20 A	24 V $\overline{\text{---}}$

The Universal range of Phaseo® power supplies also features two references for three-phase connection:

ABL 8WPS24200	480 W	20 A	24 V $\overline{\text{---}}$
ABL 8WPS24400	960 W	40 A	24 V $\overline{\text{---}}$

A range of function modules also allows functions to be added to the Universal range of Phaseo power supplies so as to help ensure continuity of service:

- A Buffer module or Battery control modules combined with their batteries to help ensure continuity of service in the event of a network power outage
- A Redundancy module to meet the most demanding requirements for continuity of service even if the power supply becomes inoperative
- Downstream electronic Protection modules to help ensure that the protection in the application is discriminating
- Converter modules delivering nominal voltages of 5 and 12 V  $\overline{\text{---}}$  from the 24 V  $\overline{\text{---}}$  output of the Universal range of Phaseo power supplies

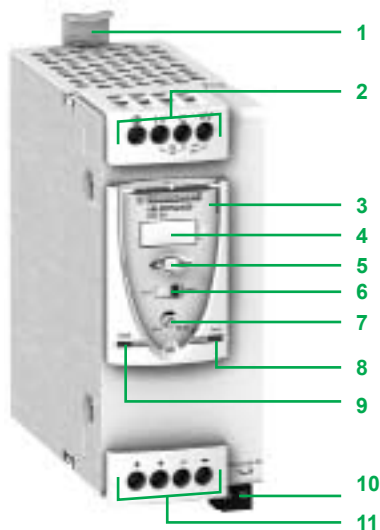

## Description

### Universal range of power supplies

The Universal range of Phaseo® regulated switch mode power supplies, **ABL 8RPS24●●0/RPM24200/WPS24●00**, is comprised of:

- 1 Spring clip for 35 mm DIN rail
- 2 4 mm<sup>2</sup> enclosed screw terminals for connection of the AC voltage (single-phase, phase-to-phase or three-phase connection)
- 3 Protective glass flap
- 4 Clip-on marker label
- 5 Locking catch for the glass flap (sealable)
- 6 Protection mode selector
- 7 Output voltage adjustment potentiometer
- 8 Output voltage status LED (green and red)
- 9 Output current status LED (green, red and orange)
- 10 Screw terminals for connection of the diagnostic relay contact, except **ABL 8RPS24030**
- 11 4 mm<sup>2</sup> (10 mm<sup>2</sup> on **ABL 8WPS24●00** and **ABL 8RPM24200**) enclosed screw terminals for connection of the DC output voltage

Technical characteristics						
Type of power supply		ABL 8RPS24030	ABL 8RPS24050	ABL 8RPS24100	ABL 8RPM24200	
<b>Certifications</b>		CB scheme EN 60950-1, UL, cCSAus, C-Tick, CE				
<b>Conformity to standards</b>	Safety	IEC/EN 60950-1, EN 61204, SELV				
	EMC	EN 61000-6-1, IEC/EN 61000-6-2, EN 61000-6-3, IEC/EN 61000-6-4, IEC/EN 61204-3				
<b>Input circuit</b>						
<b>Input values</b> phase-to-neutral (N-L1) or phase-to-phase (L1-L2)	Nominal voltage	V	100...120 V ~ / 200...500 V ~		100...120 V ~ / 200...240 V ~	
	Limit voltage	V	85...132 V ~ / 170...550 V ~		85...132 V ~ / 170...264 V ~	
	Permissible frequencies	Hz	47...63			
	Maximum inrush current	A	30 for 2 ms max.			
	Power factor		0.59 at 120 V ~ / 0.51 at 240 V ~		0.69 at 120 V ~ / 0.68 at 240 V ~	
	Efficiency at nominal load		> 87 %		> 88 %	
	Dissipated power at nominal load	W	7.8	15.5	31	57.6
<b>Anti-harmonic filtering</b>	According to IEC/EN 61000-3-2	Yes, via integrated PFC ( <i>Power Factor Correction</i> ) passive filter				
<b>Output circuit</b>						
<b>Compatibility with function modules</b>		Buffer, battery and battery check unit, redundancy, discriminating protection				
<b>Diagnostics</b>	LEDs on front panel	Current (green, orange and red), voltage (green, red and off)				
	Relay	-		Relay closed $U_{out} > 21.6$ V contact 230 V ~, 0.5 A max; 24 V ---, 5 mA min		
<b>Nominal output values</b>	Nominal output voltage ( $U_{out}$ )	V	24 ---			
	Current	A	3	5	10	20
	Power	W	72	120	240	480
<b>Permissible temporary inrush current (boost)</b>		A	1.5 $I_n$ for 4 s maximum, see curves on page 8/29			
<b>Precision</b>	Nominal output voltage ( $U_{out}$ )	V	Adjustable 24...28.8			
	Line and load regulation		1 %...3 %			
	Residual ripple - noise	mV	< 200 (peak-peak)			
<b>Holding time for I max.</b>	$U_{in} = 100$ V ~	ms	$\geq 20$			
	$U_{in} = 240$ V ~	ms	$\geq 40$			
	$U_{in} = 400$ V ~	ms	$\geq 120$			
<b>Protection</b>	Against short-circuits		Permanent, automatic or manual restart			
	Against overloads		Permanent, automatic or manual restart			
	Against overvoltages	V	30...32 ---, manual restart only			
	Against undervoltages	V	Tripping if $U_{out} < 21.6$ (in manual mode)			
	Thermal		Yes, automatic restart only			
<b>Operating and environmental characteristics</b>						
<b>Connections</b>	Input	mm <sup>2</sup>	2 x 0.5...4 screw terminals (22...12 AWG) + ground terminal			
	Output	mm <sup>2</sup>	4 x 0.5...4 screw terminals (22...12 AWG) + ground terminal (1)			
	Diagnostic relay	mm <sup>2</sup>	-	2 x 2.5 removable screw terminal block		
<b>Mounting</b>	On DIN rail		35 x 7.5 mm and 35 x 15 mm			
<b>Operating position</b>			Vertical			
<b>Connections</b>	Series		Possible, see page 8/30 of this catalog			
	Parallel		Possible, see page 8/30 of this catalog			
<b>Degree of protection</b>	Conforming to IEC/EN 60529		IP 20		IP 20, except output terminals (+,-) IP 10	
<b>Environment</b>	Operating temperature	°C	- 25...+ 60 (derating from 50°C, see page 8/28)			
	Storage temperature	°C	- 40...+ 70			
	Maximum relative humidity		90% during operation, 95% in storage			
	Vibration acc. to IEC/EN 61131-2		3...11.9 Hz amplitude 3.5 mm & 11.9 -150 Hz acceleration 2 g			
<b>Protection class</b>	According to VDE 0106 1		Class I			
<b>Dielectric strength</b> 50 Hz for 1 min	Input/output	V rms	4000 ~		3000 ~	
	Input/ground	V rms	3500 ~		2500 ~	
	Output/ground	V rms	500 ~			
<b>Input fuse incorporated</b>			No			
<b>Emissions</b> according to EN 61000-6-3	Radiation		EN 55022 Class B and GL levels			
	Conducted on the power line		EN 55022 Class B and GL levels			
	Harmonic currents		IEC/EN 61000-3-2			
<b>Immunity</b> according to IEC/EN 61000-6-2	Electrostatic discharge		IEC/EN 61000-4-2 (8 kV contact/15 kV air)			
	Radiated electromagnetic fields		IEC/EN 61000-4-3 level 3 (10 V/m)			
	Induced electromagnetic fields		IEC/EN 61000-4-6 level 3 (30 V/m)			
	Rapid transients		IEC 61000-4-4 (4 kV)			
	Surges, IEC/EN 61000-4-5		Input: 4 kV in common mode, 2 kV in differential mode Output: 2 kV in common mode, 1 kV in differential mode			
	Primary outages		IEC 61000-4-11 (voltage dips and interruptions)			

(1) No ground screw on ABL 8RPM 24200 power supply

Technical characteristics				
Type of power supply		ABL 8WPS24200	ABL 8WPS24400	
<b>Certifications</b>		CB scheme EN 60950-1, UL, cCSAus, C-Tick, CE		
<b>Conformity to standards</b>	Safety	IEC/EN 60950-1, EN 61204, SELV		
	EMC	EN 61000-6-1, IEC/EN 61000-6-2, EN 61000-6-3, IEC/EN 61000-6-4, IEC/EN 61204-3		
<b>Input circuit</b>				
<b>LED indication</b>		-		
<b>Input values</b> 3 phases (L1-L2-L3)	Nominal values	V	380-500 V ~	
	Permissible values	V	320-550 V ~	
	Permissible frequencies	Hz	47...63	
	Maximum inrush current	A	25 for 2 ms max.	
	Power factor		0.65	0.85
	Efficiency at nominal load		> 92%	
	Dissipated power at nominal load	<b>W</b>	38.4	76.8
<b>Anti-harmonic filtering</b>	According to IEC/EN 61000-3-2	Yes, via integrated PFC ( <i>Power Factor Correction</i> ) passive filter		
<b>Output circuit</b>				
<b>Compatibility with function modules</b>		Buffer, battery and battery check unit, redundancy, discriminating protection		
<b>Diagnostics</b>	LEDs on front panel	Current (green, orange and red), voltage (green, red and off)		
	Relay	Closed relay $U_{out} > 21.6$ V, contact 230 V ~, 0.5 A max; 24 V ---, 5 mA min		
<b>Nominal output values</b>	Output voltage ( $U_{out}$ )	V	24 ---	
	Current	A	0...20	0...40
	Power	<b>W</b>	480	960
<b>Permissible temporary inrush current (boost)</b>		<b>A</b>	1.5 $I_n$ for 4 s maximum, see curves on page 8/29	
<b>Precision</b>	Output voltage ( $U_{out}$ )	V	Adjustable 24...28.8	
	Line and load regulation		1 %...3 %	
	Residual ripple - noise	mV	< 200 (peak-peak)	
<b>Holding time</b> for $I_{max}$	$U_{in} = 400$ V ~	ms	≥ 18	≥ 14
	<b>Protection</b>	Against short-circuits	Permanent, automatic or manual restart	
	Against overloads	Permanent, automatic or manual restart		
	Against overvoltages	V	30...32 ---, manual restart only	
	Against undervoltages	V	Tripping if $U_{out} < 21.6$ (in manual mode)	
	Thermal	Yes, automatic restart only		
<b>Operating and environmental characteristics</b>				
<b>Connections</b>	Input	mm <sup>2</sup>	3 x 0.5...4 screw terminals (22...12 AWG) + ground	
	Output	mm <sup>2</sup>	4 x 0.5...10 screw terminals (22...8 AWG)	
	Diagnostic relay	mm <sup>2</sup>	2 x 2.5 removable screw terminal block	
<b>Mounting</b>	On DIN rail	35 x 7.5 mm and 35 x 15 mm		
<b>Operating position</b>		Vertical		
<b>Connections</b>	Series	Possible, see page 8/30 of this catalog		
	Parallel	Possible, see page 8/30 of this catalog		
<b>Degree of protection</b>	Conforming to IEC/EN 60529	IP 20 except output terminals (+, -) IP 10		
<b>Environment</b>	Operating temperature	°C	- 25...+ 60 (derating from 50°C, see page 8/28)	
	Storage temperature	°C	- 40...+ 70	
	Maximum relative humidity		90% during operation, 95% in storage	
	Vibration acc. to IEC/EN 61131-2		3...11.9 Hz amplitude 3.5 mm & 11.9 -150 Hz acceleration 2 g	
<b>Protection class</b> according to VDE 0106 1		Class I		
<b>Dielectric strength</b> 50 Hz for 1 min	Input/output	<b>V rms</b>	4000 ~	
	Input/ground	<b>V rms</b>	3500 ~	
	Output/ground	<b>V rms</b>	500 ~	
<b>Input fuse incorporated</b>		No		
<b>Emissions</b> according to EN 61000-6-3	Radiation	EN 55022 Class B and GL levels		
	Conducted on the power line	EN 55022 Class B and GL levels		
	Harmonic currents	IEC/EN 61000-3-2		
<b>Immunity</b> according to IEC/EN 61000-6-2	Electrostatic discharge	IEC/EN 61000-4-2 (8 kV contact/15 kV air)		
	Radiated electromagnetic fields	IEC/EN 61000-4-3 level 3 (10 V/m)		
	Induced electromagnetic fields	IEC/EN 61000-4-6 level 3 (30 V/m)		
	Rapid transients	IEC 61000-4-4 (4 kV)		
	Surges, IEC/EN 61000-4-5	Input: 4 kV in common mode, 2 kV in differential mode Output: 2 kV in common mode, 1 kV in differential mode		
	Primary outages	IEC 61000-4-11 (voltage dips and interruptions)		

# Modicon® Premium™ automation platform

## Power supplies and transformers

### Phaseo® Universal range switch mode power supplies for DC control circuits

#### Output characteristics

##### Derating

The ambient temperature is a determining factor that limits the power an electronic power supply can deliver continuously. If the temperature around the electronic components is too high, their life will be significantly reduced.

The nominal ambient temperature for the Universal range of Phaseo® power supplies is 50°C. Above this temperature, derating is necessary up to a maximum temperature of 60°C.

The graph below shows the power (in relation to the nominal power) that the power supply can deliver continuously, depending on the ambient temperature.

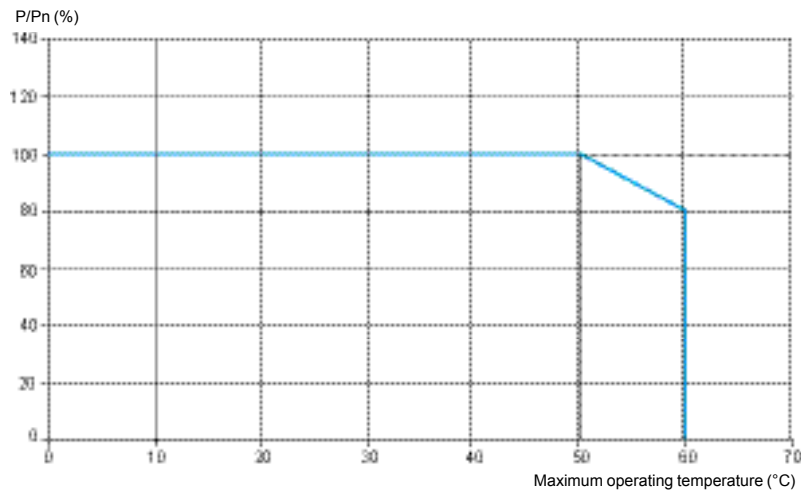

ABL 8RPM, ABL 8RPS, ABL 8WPS mounted vertically

Derating should be considered in extreme operating conditions:

- Intensive operation (output current permanently close to the nominal current, combined with a high ambient temperature)
- Output voltage set above 24V (to compensate for line voltage drops, for example)
- Parallel connection to increase the total power

#### General rules to be complied with

<b>Intensive operation</b>	See derating on above graph. Example for ABL 8RPS: - Without derating, from 0°C to 50°C - Derating of nominal current by 2%, per additional °C, up to 60°C
<b>Rise in output voltage</b>	The nominal power is fixed. Increasing the output voltage means that the current delivered must be reduced.
<b>Mounting</b>	To allow heat dissipation, the power supplies must not be in contact with each other.

There must be adequate convection around the products to assist cooling. There must be sufficient clearance around the Universal range of Phaseo® power supplies:

- 50 mm above and below
- 10 mm on the sides



#### Output characteristics (continued)

##### Behavior in the event of overloads

Behavior in the event of overloads:

**Automatic reset protection mode (current limiting):** If the output current exceeds approximately  $1.2 I_n$ , the output current is limited to this value. The value of the output voltage can then be less than 21 V but the diagnostic relay opens, allowing the anomaly to be fed back to the automation system and thus prevent feedback of any undefined logic state. On elimination of the overload, the output voltage reverts to its preset value.

**Manual reset protection mode (undervoltage detection):** If the output current exceeds approximately  $1.2 I_n$ , the power supply stops completely before the output voltage drops below 21 V and no longer delivers any current. The detected fault is memorized as long as voltage is present at the power supply primary. The power supply will become operational again, if the detected fault has disappeared, after de-energizing the primary for a few seconds.

*Note: In both these modes, any overload of less than  $1.5 I_n$  and lasting less than 4 s will be absorbed by the "boost" circuit and the voltage delivered will stay within the specified limits (adjustment voltage +/- 3%).*

##### Load limit

###### Manual reset protection mode

ABL 8RPM24200/ABL 8RPS24●●●/ABL 8WPS24●●●

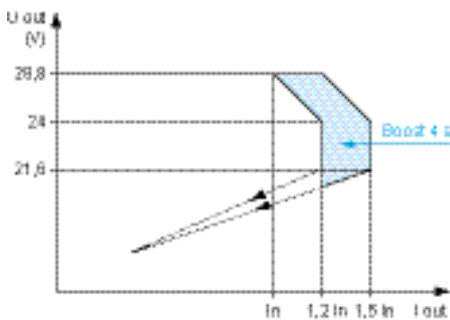

###### Automatic reset protection mode

ABL 8RPM24200/ABL 8RPS24●●●/ABL 8WPS24●●●

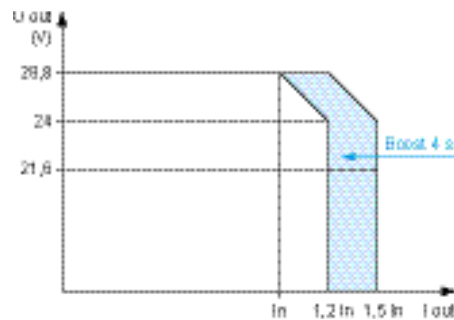

##### "Boost" repeat accuracy

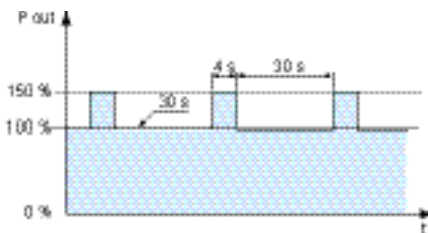

The **ABL 8RPS/RPM/WPS** Universal range of Phaseo® power supplies has a power reserve, allowing them to supply the application with energy up to 1.5 times the nominal current at the intervals illustrated by the graph opposite.

The "boost" amplitude and repeat accuracy depend on:

- The overload duration
- The overload intensity
- The period between each consumption peak

When the power supply can no longer cope (repeated overloads, overload duration > 4 seconds, power rating > 150% of nominal power) the integrated protection trips.

This type of operation is described in detail in the user manual, which can be downloaded from our website, [www.schneider-electric.com](http://www.schneider-electric.com).

##### Behavior in the event of phase failure on three-phase power supplies

The **ABL 8WPS24●00** Universal range of Phaseo® power supplies is capable of starting and delivering a nominal current and voltage for a few minutes in the event of failure of one phase. Their protection (thermal) then trips and they are reset automatically.

Output characteristics (continued)

Series or parallel connection

Series connection

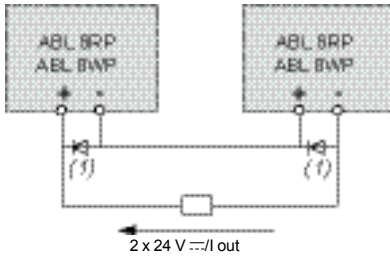

Parallel connection

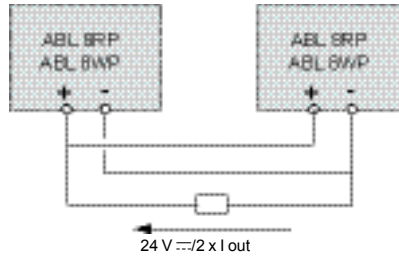

Family	Series	Parallel
ABL 8RPS/8RPM/8WPS	2 products max. (1)	2 products max.

Note: Series or parallel connection is only recommended for products with identical references.

For better availability, the power supplies can also be connected in parallel using the **ABL8 RED24400** Redundancy module.

Selection of protection on the power supply primaries

Type of line supply	115 V ~ phase-to-neutral			230 V ~ phase-to-phase			400 V ~ phase-to-phase	
	Thermal-magnetic circuit-breaker		gG/gL fuse	Thermal-magnetic circuit-breaker		gG/gL fuse	Thermal-magnetic circuit-breaker	gG/gL fuse
	(2) GB2 (IEC) (4)	(3) C60N (IEC/UL)	–	(2) GB2 (IEC) (4)	(3) C60N (IEC/UL)	–	(2) GV2 (IEC/UL)	–
ABL 8RPS24030	GB2 CD07	MG24443	2 A (8 x 32)	GB2 CD07	MG24443	2 A (8 x 32)	GV2 RT06 GV2 ME06 (5)	2 A (14 x 51)
ABL 8RPS24050	GB2 CD08	MG24444	4 A (8 x 32)	GB2 CD07	MG24443	2 A (8 x 32)	GV2 RT06 GV2 ME06 (5)	2 A (14 x 51)
ABL 8RPS24100	GB2 CD12	MG24447	6 A (8 x 32)	GB2 CD08	MG24444	4 A (8 x 32)	GV2 RT07 GV2 ME07 (5)	4 A (14 x 51)
ABL 8RPM24200	GB2 CD16	MG24449	10 A (8 x 32)	GB2 CD12	MG24447	6 A (8 x 32)	–	–
ABL 8WPS24200	–	–	–	–	–	–	GV2 ME06 (6)	2 A (14 x 51)
ABL 8WPS24400	–	–	–	–	–	–	GV2 ME07 (6)	4 A (14 x 51)

Schemes

GB2 CD●●



GV2 RT●●

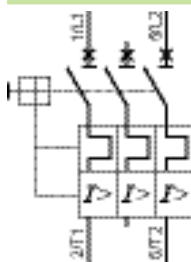

GV2 ME●●

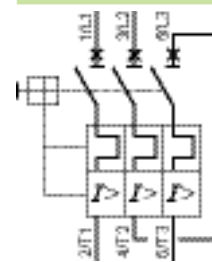

(5) Connection in single-phase (L-N) or phase-to-phase (L1-L2)

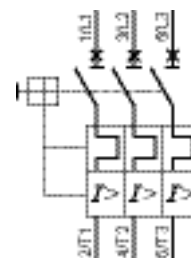

(6) Connection in 3 phase (L1-L2-L3)

(1) Two Schottky diodes  $I_{min}$  = power supply  $I_n$  and  $V_{min}$  = 50 V.

(2) Automation and Control offer.

(3) Electrical Distribution offer.

(4) UL certification pending.

# Modicon® Premium™ automation platform

Power supplies and transformers

Phaseo® Universal range switch mode power supplies  
for DC control circuits



ABL 8RPS24050



ABL 8RPM24200



ABL 8WPS24200



ABL 8BUF24400



ABL 8BBU24200



ABL 8RED24400

## Regulated switch mode power supplies: Phaseo® Universal range

Input voltage	Secondary		Reset	Conforming to standard IEC/EN 61000-3-2	Reference	Weight kg
	Output voltage	Nominal power				
<b>Single-phase (N-L1) or 2-phase (L1-L2) connection</b>						
100...120 V - 200...500 V ~ - 15%, + 10% 50/60 Hz	24...28.8 V	72 W	3 A	Auto/man	Yes	ABL 8RPS24030 0.300
	---	120 W	5 A	Auto/man	Yes	ABL 8RPS24050 0.700
	---	240 W	10 A	Auto/man	Yes	ABL 8RPS24100 1.000
100...120 V/200...240 V ~ - 15%, + 10% 50/60 Hz	24...28.8 V	480 W	20 A	Auto/man	Yes	ABL 8RPM24200 1.600
	---	---	---	---	---	---
<b>Three-phase connection (L1-L2-L3)</b>						
380...500 V ~ ± 10 % 50/60 Hz	24...28.8 V	480 W	20 A	Auto/man	Yes	ABL 8WPS24200 1.600
	---	960 W	40 A	Auto/man	Yes	ABL 8WPS24400 2.700

## Function modules for continuity of service (1)

Function	Use	Designation	Reference	Weight kg
<b>Continuity after a power outage</b>	Holding time 100 ms at 40 A and 2 s at 1 A	Buffer module	ABL 8BUF24400	1.200
	Holding time 9 min at 40 A...2 hrs at 1 A (depending on use with a Battery control module-battery unit and load) (2)	Battery control module 20 A output current	ABL 8BBU24200	0.500
		Battery control module 40 A output current	ABL 8BBU24200	0.700
		3.2 Ah battery module (3)	ABL 8BPK24A03	3.500
		7 Ah battery module (3)	ABL 8BPK24A03	6.500
	12 Ah battery module (3)	ABL 8BPK24A12	12.000	
<b>Continuity after a malfunction</b>	Paralleling and redundancy of the power supply to help ensure uninterrupted operation of the application excluding AC line failures and application overloads	Redundancy module	ABL 8RED24400	0.700
<b>Discriminating downstream protection</b>	Electronic protection (1...10 A overload or short-circuit) with 4 output terminals from a Universal range Phaseo power supply	Protection module with 2-pole breaking (4) (5)	ABL 8PRP24100	0.270

## --- / --- converters (1)

Primary (6)	Secondary		Reference	Weight kg
	Universal range power supply module output current	Output voltage		
24 V --- - 9%, + 24%	2.2 A	5...6.5 V ---	6 A	ABL 8DCC05060 0.300
	1.7 A	7...15 V ---	2 A	ABL 8DCC12020 0.300

## Separate and replacement parts

Designation	Use	Composition	Unit reference	Weight kg
<b>Fuse assemblies</b>	For ABL 8PRP24100 discriminating Protection modules	4 x 5 A, 4 x 7.5 A and 4 x 10 A	ABL 8FUS01	—
	For ABL 8BKP24A●● Battery	4 x 20 A and 6 x 30 A	ABL 8FUS02	—
<b>Clip-on marker labels</b>	All products except ABL 8PRP24100	Order in multiples of 100	LAD 90	0.030
	ABL 8PRP24100 selective Protection Module	Order in multiples of 22	ASI20 MACC5	—
<b>DIN rail mounting kit</b>	ABL 8BPK2403 Battery Module	—	ABL 1A02	—
<b>EEPROM memory</b>	Backup and duplication of ABL8 BBU24●00 battery control module parameters	—	SR2 MEM02	0.010

(1) For use with Universal range of Phaseo® power supplies.

(2) For table of compatibility of Battery control module-battery unit with holding time depending on the load.

(3) Supplied with 20 or 30 A fuse depending on the model.

(4) Supplied with four 15 A fuses.

(5) Local reset via pushbutton or automatic reset on elimination of the detected fault.

(6) Voltage from a 24 V --- Universal range Phaseo power supply.

## Dimensions

ABL 8RPS24.../ABL 8RPM24200/ABL 8WPS24...  
Common side view

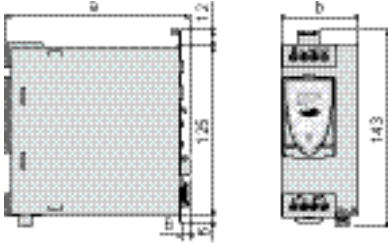

ABL 8	a	b
RPS24030	120	44
RPS24050	120	56
RPS24100	140	85
RPM24200	140	145
WPS24200	155	95
WPS24400	155	165

## Internal schemes

ABL 8RPS24030

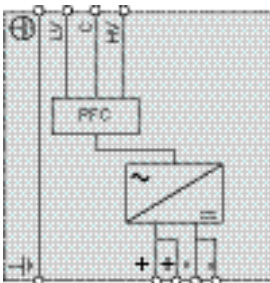

ABL 8RPS24050

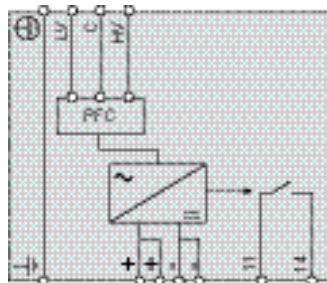

ABL 8RPS24100

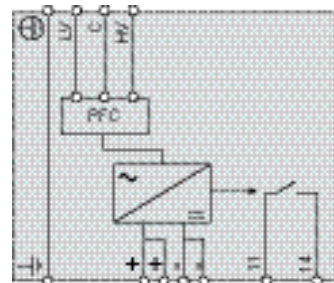

ABL 8RPM24200

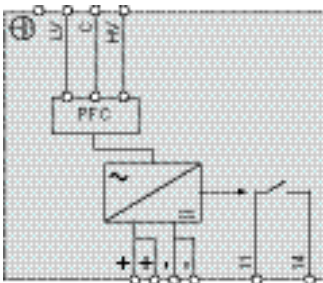

ABL 8WPS24200

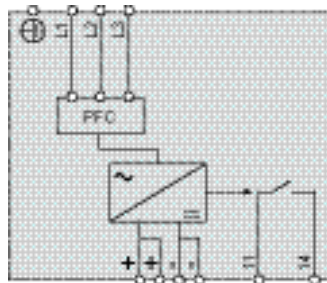

ABL 8WPS24400

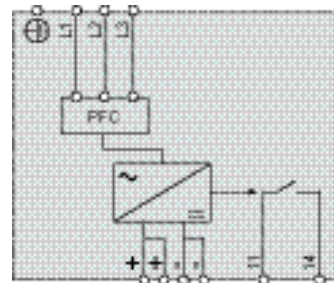

## Line supply connection schemes

Single-phase (L-N) 100 to 120 V

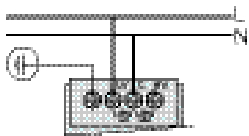

Phase-to-phase (L1-L2) 200 to 500 V

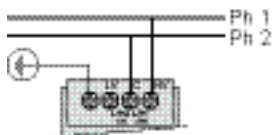

Three-phase (L1-L2-L3) 3 x 380 to 500 V

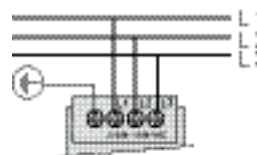

Single-phase (L-N) 200 to 500 V

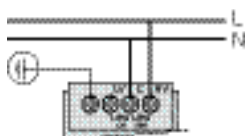

# Modicon® Premium™ automation platform

Power supplies and transformers

Phaseo® AS-Interface® range switch mode power supplies

## Power supplies for AS-Interface® cabling system

Consistent with the standard Phaseo® line, the range of **ASI ABL** power supplies is designed to deliver a  $\sim$  voltage, as required by AS-Interface® cabling systems. Three versions are available to meet the needs encountered in industrial applications, in enclosures, cells or floor-standing enclosures. These single-phase, electronic, switch mode power supplies help to ensure the quality of the output current, in accordance with the electrical characteristics and conforming to standard EN 50295.

### ASI ABLB300●

Operating on a 100 to 240 V  $\sim$  supply, this power supply delivers a voltage of 30 V  $\sim$ . Available in 2.4 and 4.8 A ratings, the outgoing terminal block allows the cable to be connected separately to the AS-Interface interface modules and to the AS-Interface master. Input and output LEDs allow fast and continuous diagnostics.



ASI ABLB3002

### ASI ABLD300●

Operating on a 100 to 240 V  $\sim$  supply, this power supply delivers a voltage of 30 V  $\sim$ . Available in 2.4 and 4.8 A ratings, it allows diagnosis and management of detected ground faults on AS-Interface interface modules. In the event of a detected ground fault, the Phaseo® power supply stops dialog on the AS-Interface® cabling system and puts the installation in a fallback condition. Restarting is only possible after deliberate acknowledgement of the detected fault. Two inputs/outputs enable dialog with a processing unit. The outgoing terminal block is used to connect the AS-Interface® cable separately to the interface modules and master modules. Input, output and detected ground fault LED's allow fast and continuous diagnostics.



ASI ABLD3004

### ASI ABLM3024

Operating on a 100 to 240 V  $\sim$  supply, this product provides two separate power supplies, which are totally independent in the way they operate. Two output voltages - 30 V/2.4 A (AS-Interface® line supply) and 24 V/3 A - are available, so making it possible to supply the control equipment without an additional power supply. Input and output LEDs allow fast and continuous diagnostics.



ASI ABLM3024

Technical characteristics								
<b>Type of power supply</b>			<b>ASIABLB3002</b>	<b>ASIABLB3004</b>	<b>ASIABLD3002</b>	<b>ASIABLD3004</b>	<b>ASIABLM3024</b>	
<b>Functions</b>			Supply to the AS-Interface® line (30 V $\bar{\bar{c}}$ )				30 V $\bar{\bar{c}}$ supply	24 V $\bar{\bar{c}}$ supply
<b>Product certifications</b>			UL 508, CSA 22-2 n°950, TÜV 60950-1					
<b>Conforming to standards</b>	Safety		IEC/EN 60950-1					
	EMC		EN 50081-1, IEC/EN 61000-6-2, EN 55022 class B					
	Low frequency harmonic currents		No					
<b>Input circuit</b>								
<b>LED indication</b>			Orange LED					
<b>Input voltage</b>	Rated values	<b>V</b>	~ 100...240					
	Permissible values	<b>V</b>	~ 85...264					
	Current consumption	<b>A</b>	0.5	1	0.5	1		
	Permissible frequencies	<b>Hz</b>	47...63					
	Current at switch-on	<b>A</b>	< 30					
	Power factor		0.65					
	Efficiency at nominal load	<b>%</b>	> 83				> 83	> 80
	Dissipated power at nominal load	<b>W</b>	14.7	29.5	14.7	29.5	14.7	36
	<b>Output circuit</b>							
<b>LED indication</b>			Green LED					
<b>Nominal output values</b>	Voltage ( $U_{out}$ )	<b>V</b>	30 (AS-Interface)				$\bar{\bar{c}}$ 30	$\bar{\bar{c}}$ 24
	Current	<b>A</b>	2.4	4.8	2.4	4.8	2.4	3
	Power	<b>W</b>	72	144	72	144	72	72
<b>Precision</b>	Adjustable output voltage	<b>V</b>	-				-	100 to 120 %
	Line and load regulation		3 %					
	Residual ripple - noise	<b>mV</b>	300 - 50					
<b>Holding time for <math>I_{max}</math></b>	$U_{in, min}$	<b>ms</b>	$\geq 10$					
	<b>Protection</b>		Against short-circuit				Permanent. Automatic restart after elimination of the detected fault	
		Against overload				1.1 $I_n$		
		Against overvoltage				Tripping if $U > 1.2 U_n$		
						$U > 1.2 U_n$	$U > 1.5 U_n$	
		Against undervoltage				Tripping if $U < 0.95 U_n$		
						$U < 0.95 U_n$	$U < 0.8 U_n$	
<b>Operating characteristics</b>								
<b>Connections</b>	Input	<b>mm<sup>2</sup></b>	2 x 2.5 screw terminals + ground					
	Output	<b>mm<sup>2</sup></b>	2 x 2.5 screw terminals + ground, multiple output					
<b>Environment</b>	Operating temperature	<b>°C</b>	0 to + 60 (derating from 50, see page 8/36 of this catalog)					
	Storage temperature	<b>°C</b>	- 25 to + 70					
	Maximum relative humidity		95 % (without condensation or dripping water)					
	Degree of protection		IP 20 (conforming to IEC/EN 60529)					
	Vibrations		IEC/EN 61131-2					
<b>Operating position</b>			Vertical					
<b>MTBF</b>		<b>h</b>	> 100000 (conforming to Bell core, at 40 °C)					
<b>Dielectric strength 50 Hz during 1 min</b>	Input/output	<b>V rms</b>	3000					
	Input/ground	<b>V rms</b>	3000					
	Output/ground (and output/output)	<b>V rms</b>	500					
<b>Input fuse incorporated</b>			Yes (not interchangeable)					
<b>Emission according to EN 61000-6-3</b>	Conducted/radiated		Class B (conforming to EN 55022)					
<b>Immunity according to IEC/EN 61000-6-2</b>	Electrostatic discharge		IEC/EN 61000-4-2 (4 kV contact/8 kV air)					
	Radiated electromagnetic field		IEC/EN 61000-4-3 level 3 (10 V/m)					
	Induced electromagnetic field		IEC/EN 61000-4-6 (10 V/m)					
	Rapid transients		IEC 61000-4-4 level 3 (2 kV),					
	Primary outages		IEC 61000-4-11 (voltage dips and interruptions)					

**Output characteristics**

**Derating**

The ambient temperature is a determining factor which limits the power that an electronic power supply can deliver continuously. If the temperature around the electronic components is too high, their life will be significantly reduced. The graph below shows the power (in relation to the nominal power) which the power supply can deliver continuously, according to the ambient temperature.

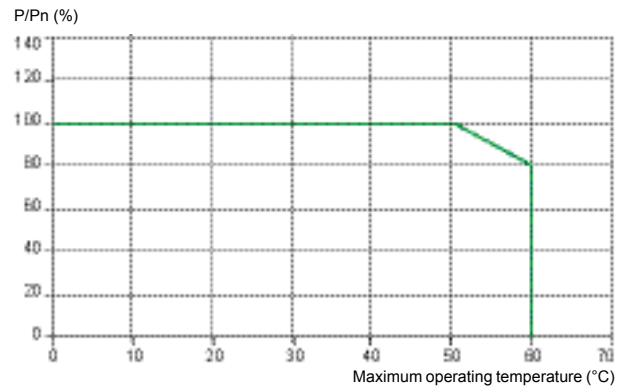

**Function diagram**

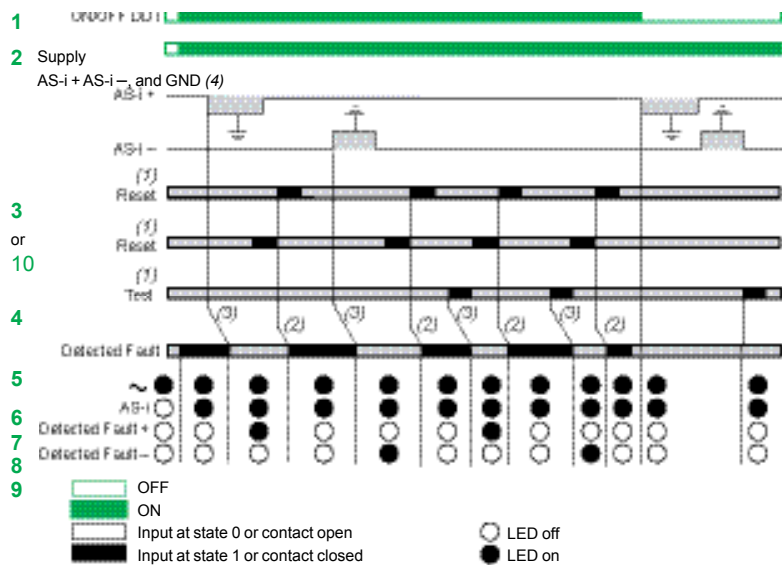
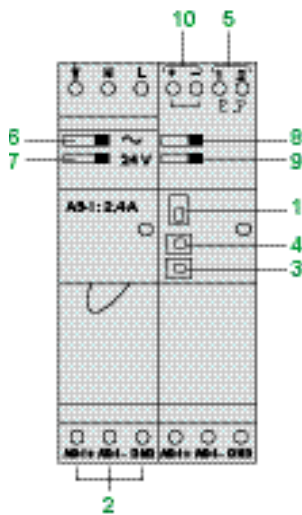

(1) 30 ms min. (2) 15 ms. (2) 20 ms.  
(4) Warning: the ground fault detector will only operate if the ground (GND) terminal is connected.

**Warning**

- The ground (GND) (4) connection must be made. In the event of disconnection, the built-in detector becomes inoperative. To obtain ground connection diagnostics, it is recommended that an ASI ABLD300 power supply be used with built-in insulation control.
- The appearance of a ground fault will trigger, in the following cases, the activation of built-in protection:
  - case 1: detected fault between AS-i "+" and ground,
  - case 2: detected fault between AS-i "-" and ground,
  - case 3: detected fault between sensors/actuators (supplied by ASI ABLD300) and ground.

In cases 1 and 2 with switch 1 ON -> OFF: maintain of fault, any exchange between master and slaves.

In case 3 with switch 1 ON -> OFF: restart of exchanges between master and slaves but the states of inputs/outputs of affected module may not be correct.



## Selection of protection on the power supply primaries

Type of mains supply	~ 115 V single-phase			~ 230 V single-phase		
	Power supply		Gg fuse	Power supply		Gg fuse
ASI ABLB3002	GB2 ●B07	MG24517 (2)	2 A	GB2 DB06	MG24516 (2)	2 A
ASI ABLB3004	GB2 ●B08	MG24518 (2)	4 A	GB2 DB07	MG17453 (2)	2 A
ASI ABLD3002	GB2 ●B07	MG24517 (2)	2 A	GB2 DB06	MG24516 (2)	2 A
ASI ABLD3004	GB2 ●B08	MG24518 (2)	4 A	GB2 DB07	MG17453 (2)	2 A
ASI ABLM3024	GB2 ●B07	MG24517 (2)	2 A	GB2 DB06	MG17453 (2)	2 A

(1) Single-phase protection, replace ● by C; 2-pole protection, replace ● by D.  
(2) UL certified circuit breaker.

## References



ASI ABL●3002

Input voltage	Secondary			Auto-protect	Ground fault	Reference	Weight
	Output voltage	Nominal power	Nominal current	reset	detection		kg
<b>Single phase (N-L1) or 2-phase (L1-L2)</b>							
~ 100...240 V - 15 %, + 10 % 50/60 Hz	≡ 30 V	72 W	2,4 A	Auto	No	ASI ABLB3002	0.800
		144 W	4,8 A	Auto	No	ASI ABLB3004	1.300
	≡ 30 V	72 W	2,4 A	Auto	Yes	ASI ABLD3002	0.800
		144 W	4,8 A	Auto	Yes	ASI ABLD3004	1.300
≡ 24 V	72 W	2,4 A	Auto	No	ASI ABLM3024	1.300	
	72 W	3 A					

## Dimensions

Common side view  
Mounting on DIN 35 and 75 mm rail

ASI ABLB3002  
ASI ABLD3002

ASI ABLB3004 / ABLD3004  
ASI ABLM3024

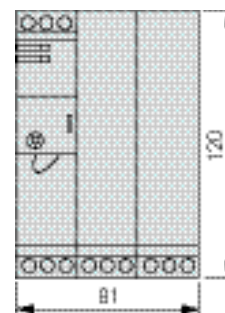
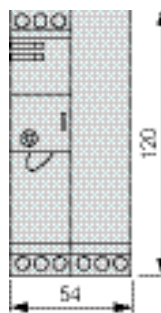
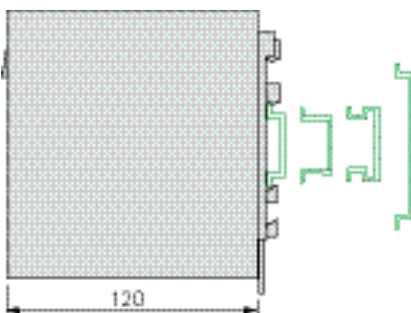

## Schemes

ASI ABLB300●

ASI ABLD300●

ASI ABLM3024

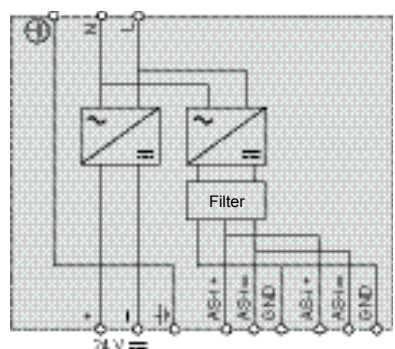
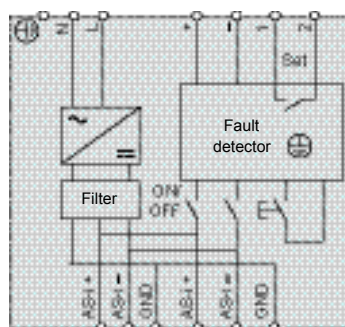
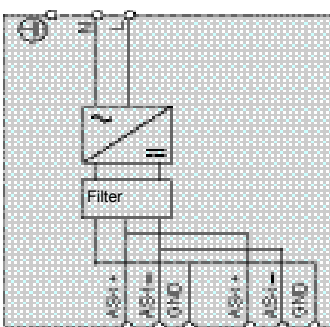



---

## 9.1 - Treatment for severe environments

- Conformal Coating Premium™ modules ..... 9/2

## 9.2 - TSX™ PSY power supply modules

- Module selector ..... 9/6

## 9.3 - Technical information

- Standards and certifications. .... 9/8
- Protective treatment of Modicon® Premium™ PLCs ..... 9/8
- Environment tests ..... 9/9
- Ethernet network, infrastructure. .... 9/12
- EC Regulations ..... 9/18
- MFB (Motion Function Blocks) Library
  - Motion Control ..... 9/20

## 9.4 - Index

- Product reference index. .... 9/22

# Modicon® Premium™ automation platform

Treatment for severe environments  
Conformal coating modules

## Presentation

### Protective treatment of Modicon® Premium™ platforms

The Modicon® Premium™ automation platform meets the requirements of “**TC**” treatment (Treatment for all Climates).

For installations in industrial production workshops or environments corresponding to “**TH**” treatment (Treatment for hot and Humid environments), Modicon Premium PLCs must be embedded in envelopes with a minimum IP 54 protection, in compliance with IEC/EN 60529 or equivalent level according to NEMA 250.

Modicon Premium PLCs themselves offer **protection to IP 20 level and protection against pins** (enclosed equipment) (1). They can therefore be installed without an envelope in reserved-access areas which do not exceed **pollution level 2** (control room with no dust-producing machine or activity). The pollution level 2 does not take account of more severe environmental conditions: air pollution by dust, smoke, corrosive or radioactive particles, vapours or salts, attack by fungi, insects, ...

### Treatment for environments more severe

If the Modicon® Premium™ PLC needs to be used in an environment more severe than the specified characteristics, it's possible to get processor and power supply modules, I/O modules on bus X and racks with a Conformal Coated protection: **Humiseal 1A33** type coated on electronic cards.

The Conformal Coated protection increases the isolation capability of the treated circuit board like their resistance to:

- condensation
- dusty atmosphere (conducting foreign particles)
- corrosion more particularly at the time of a use in sulfur atmosphere (oil refinery, purification plant,...) or halogens atmosphere (chlorine, ...).

These protection, associated with the appropriate installation and maintenance allows to use the Modicon Premium products in the hard chemical environment like **3C2** and **3C3 types** according to IEC/EN 60721-3-3.

The functional and electrical characteristics of these modules are the same as the characteristics of their standard equivalent modules. Please, consult the characteristics pages in chapter 1 to chapter 5.

To order a Conformal Coating modules and racks, see pages 9/3 to 9/5 (“**C**” added at the end of the standard reference).

(1) In the case where a position is not occupied by a Premium™ module, a **TSX™ RKA 02** protective cover must be installed (sold in lots of 5).

# Modicon® Premium™ automation platform

Treatment for severe environments  
Conformal coating modules

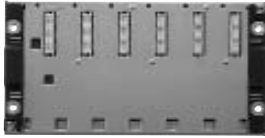

TSX RKY 6C

Racks				
Description	Capacity	Reference	Weight	kg
Non-extendable racks	6 positions	TSX™ RKY 6C	1.470	
	8 positions	TSX RKY 8C	1.760	
	12 positions	TSX RKY 12C	2.310	
Extendable racks	4 positions	TSX RKY 4EXC	1.160	
	6 positions	TSX RKY 6EXC	1.500	
	8 positions	TSX RKY 8EXC	1.780	
	12 positions	TSX RKY 12EXC	2.340	
	Requires on the en racks 1 line terminator TSX TLY EX Sold in lots of 2			

Connection accessories, see page 2/5.



TSX P57 1634MC

Premium™ TSX™ 57 Unity™ processors					
I/O capacity	Capacity	Network	Integrated port	Reference	Weight
	Memory				kg
TSX™ 57 1● 512 discrete I/O, 24 analog I/O and 8 application-specific channels	96 Kb integrated, 224 Kb on PCMCIA	1	–	(1) TSX™ P57 104MC	0.380
		0	Ethernet	TSX P57 1634MC	–
		1	Fipio®	(1) TSX P57 154MC	0.420
TSX 57 2● 1024 discrete I/O, 80 E/S analog I/O and 24 application-specific channels	160 Kb integrated 768 Kb on PCMCIA	1	–	TSX P57 204MC	0.520
		–	Ethernet	TSX P57 2634MC	–
		2	Hot Standby dedicated	TSX H57 24MC	0.560
TSX 57 3● 1024 discrete I/O, 128 E/S analog I/O and 32 application-specific channels	192 Kb integrated 1792 Kb on PCMCIA	1	Fipio	TSX P57 254MC	–
		3	–	TSX P57 304MC	0.520
		2	Ethernet	TSX P57 3634MC	–
TSX 57 4● 2040 discrete I/O, 256 E/S analog I/O and 64 application-specific channels	208 Kb integrated 1792 Kb on PCMCIA	3	Fipio	TSX P57 354MC	0.560
		3	Ethernet	TSX P57 4634MC	0.610
		4	Hot Standby dedicated	TSX H57 44MC	0.610
TSX 57 5● 2040 discrete I/O, 512 E/S analog I/O and 64 application-specific channels	440 Kb integrated 2048 Kb on PCMCIA	4	Fipio	TSX P57 454MC	0.560
		3	Ethernet	TSX P57 5634MC	0.610
		4	Fipio	TSX P57 554MC	0.560
TSX 57 6● 2040 discrete I/O, 512 E/S analog I/O and 64 application-specific channels	1 Mb integrated 7168 Kb on PCMCIA	3	Ethernet	TSX P57 6634MC	0.610
		4	Fipio	TSX P57 6634MC	0.610



TSX P57 25●MC/35●MC/4534MC

Connection cables, see page 1/13.



TSX P57 4634MC/5634MC/6634MC

Premium TSX 57 PL7™ processors					
I/O capacity	Capacity	Network	Integrated port	Reference	Weight
	Memory				kg
TSX™ 57 1● 512 discrete I/O, 24 analog I/O and 8 application-specific channels	32 K words integrated, 644 K words on PCMCIA	1	–	(1) TSX P57 103MC	0.380
		0	Fipio®	(1) TSX P57 153MC	0.420
TSX 57 2● 1024 discrete I/O, 80 E/S analog I/O and 24 application-specific channels	48 K words integrated 160 K words on PCMCIA	1	–	TSX P57 203MC	0.520
		–	Ethernet	TSX P57 2623MC	–
		1	Fipio	TSX P57 253MC	0.560
TSX 57 3● 1024 discrete I/O, 128 E/S analog I/O and 32 application-specific channels	64 K words integrated 160 K words on PCMCIA	–	Ethernet and Fipio	TSX P57 2823MC	–
		3	–	TSX P57 3034MC	0.520
		2	Ethernet	TSX P57 36234MC	–
TSX 57 4● 2040 discrete I/O, 256 E/S analog I/O and 64 application-specific channels	80/96 K words integrated (2) 384 K words on PCMCIA	3	–	(1) TSX P57 3534L4MC	0.420
		–	Fipio	TSX P57 3534MC	0.560
		4	Fipio	TSX P57 4534MC	0.560
TSX 57 5● 2040 discrete I/O, 256 E/S analog I/O and 64 application-specific channels	96/176 K words integrated (2) 992 K words on PCMCIA	4	Ethernet and Fipio	TSX P57 48234MC	–
		4	Ethernet and Fipio	TSX P57 48234MC	–



TSX MRP C00●MC

PCMCIA SRAM memory extensions cards				
Description	Memory size		Reference	Weight
	Application	Additional data		
Configurable SRAM application/file memory extensions (slot 0 of processors)	192 Kb...1024 Kb	832 Kb...0 Kb	TSX™ MRP C001MC	0.076
	192 Kb...3072 Kb	2880 Kb...0 Kb	TSX MRP C003MC	0.076
	192 Kb...7168 Kb	6976 Kb...0 Kb	TSX MRP C007MC	0.076

Replacement parts, see page 1/33.

(1) Single-format module, the other processors module are in double-format.

(2) The second value corresponds to the integrated RAM when the application program is supported by the PCMCIA card.

# Modicon® Premium™ automation platform

Treatment for severe environments  
Conformal coating modules



TSX PSY double-format

Power supply modules						
Power supply	Available power				Reference	Weight kg
	5 V	24 VR	24 VC	Total		
24 non isolated	15 W	15 W	–	30 W	(1) TSX™ PSY 1610MC	0.540
	35 W	19 W	–	50 W	TSX PSY 3610MC	0.780
24...48 V isolated	35 W	19 W	–	50 W	TSX PSY 5520MC	0.980
~ 110...240 V	25 W	15 W	12 W	26 W	(1) TSX PSY 2600MC	0.510
~ 110...120 V and ~ 200...240 V	35 W	19 W	19 W	50 W	TSX PSY 5500MC	0.620
	75 W	–	38 W TBTS	77 W	TSX PSY 8500MC	0.740

Accessories and fan modules, see page 2/5.

(1) Single-format module, the other power supply modules are in double-format.



TSX DEY/DSY/AEY/ASY with screw terminal block

Discrete I/O modules						
Type	Voltage, logic	Connection by	Description	Reference	Weight kg	
24 inputs	24 V, positive logic	Screw terminal block	8 isolated inputs, type 2	TSX™ DEY 08D2C	0.300	
			16 isolated inputs, type 2	TSX DEY 16D2C	0.300	
	48 V, positive logic	Screw terminal block	16 isolated inputs, type 2	TSX DEY 16D3C	0.300	
			24 V, positive logic	HE 10 connector	16 isolated fast inputs type 1	TSX DEY 16FKC
	24 V, négative logic	Screw terminal block	2 x HE 10 connectors	32 isolated inputs, type 1	TSX DEY 32D2KC	0.300
			4 x HE 10 connectors	64 isolated inputs, type 1	TSX DEY 64D2KC	0.370
24 V, négative logic	Screw terminal block	16 isolated inputs, type 2	TSX DEY 16A2C	0.310		
~ 50/60 Hz inputs	48 V, logique positive	2 x HE 10 connectors	32 isolated inputs, type 2	TSX DEY 32D3KC	0.310	
	24 V	Screw terminal block	16 isolated inputs, type 2	TSX DEY 16A2C	0.310	
	48 V	Screw terminal block	16 isolated inputs, type 2	TSX DEY 16A3C	0.320	
	100...120 V	Screw terminal block	16 isolated inputs, type 2	TSX DEY 16A4C	0.320	
200...240 V	Screw terminal block	16 isolated inputs, type 2	TSX DEY 16A5C	0.360		
24 solid state outputs	24 V/0,5 A, posit. log.	Screw terminal block	8 protected outputs	TSX™ DSY 08T2C	0.320	
			24 V/2 A, posit. logic	Screw terminal block	8 protected outputs	TSX DSY 08T22C
	24 V/0,5 A, posit. log.	Screw terminal block	16 protected outputs	TSX DSY 16T2C	0.340	
			48 V/1 A, posit. logic	Screw terminal block	8 protected outputs	TSX DSY 08T31C
	48 V/0,25 A, posit. log.	Screw terminal block	16 protected outputs	TSX DSY 16T3C	0.340	
			24 V 0,1 A, posit. logic	2 x HE 10 connectors	32 protected outputs	TSX DSY 32T2KC
4 x HE 10 connectors	64 protected outputs	TSX DSY 64T2KC	0.360			
24 or ~ relay outputs	24 V/3 A, ~ 24 to 240 V/3 A	Screw terminal block	8 sorties non protégées	TSX DSY 08R5C	0.330	
			16 not protected outputs	TSX DSY 16R5C	0.380	
	24 to 48 V/5 A, ~ 24 to 240 V/5 A	Screw terminal block	8 protected outputs	TSX DSY 08R5AC	0.420	
24 relay outputs	24...120 V 5 A	Screw terminal block	8 protected outputs	TSX DSY 08R4DC	0.370	
~ triac outputs	4...120 V 1 A	Screw terminal block	16 not protected outputs	TSX DSY 16S4C	0.380	
24 inputs/outputs	E: 24 V, positive logic S: 24 V/0,5 A	2 x HE 10 connectors	16 isolated fast inputs, type 1 12 protected outputs	TSX™ DMY 28FKC	0.320	
			16 isolated fast inputs, type 1 12 protected outputs reflex or time-delayed	TSX DMY 28RFKC	0.355	

Screw terminal block, connecting accessories and separate parts, see page 3/16.



TSX DEY/DMY 32/24 voies with HE 10 connectors



TSX DEY/DSY 64 voies with HE 10 connectors

Analog I/O modules				
Type	Description	Connection by	Reference	Weight kg
Analog inputs	4 channels, high level voltage/current 16 bits	SUB-D 25 connector	TSX™ AEY 420C	0.330
	4 isolated channels, low level voltage/current, temperature probe/thermocouple 16 bits	Screw terminal block	TSX AEY 414C	0.320
	8 channels, high level voltage/current 12 bits	SUB-D 25 connector	TSX AEY 800C	0.310
	16 channels, high level voltage/current 12 bits	2 SUB-D 25 connectors	TSX AEY 1600C	0.340
	8 isol.channels, high level voltage/current 16 bits	SUB-D 25 connector	TSX AEY 810C	0.330
Analog outputs	16 channels, thermocouple 16 bits	2 SUB-D 25 connectors	TSX AEY 1614C	0.350
	4 isolated channels, voltage/current 11 bits + sign	Screw terminal block	TSX™ ASY 410C	0.350
	8 channels, voltage/current 13 bits + sign	SUB-D 25 connector	TSX ASY 800C	–



TSX CTY 2AC/2CC

### Counter modules

Type of input	Function	Nb of channels	Reference	Weight kg
2/3 fils sensors 24 V	Counting 40 kHz	2	TSX™ CTY 2AC	0.320
Incremental encoder 5 V RS 232 and 10...30 V Totem Pôle		4	TSX CTY 4AC	0.430
SSI serial or parallel absolute encoders (1)	Counting and measuring 40 kHz	2	TSX CTY 2CC	0.340
	Electronic cam	1	TSX™ CCY 1128C	0.480

Accessories and connecting cables, see page 4/23, 4/27 and 4/30.

(1) With TSX CTY 2CC and TSX CCY 1128C modules.



TSX CAY 41C/42C

### Motion control modules

Type of input	Function	Nb of channels	Reference	Weight kg
Amplifier with RS422 I/O, I 5 V TTL and O 5 V with open collector	Modules for stepper motors	1	TSX™ CFY 11C	0.440
		2	TSX CFY 21C	0.480
Incremental encoder 5 V RS 232 and 10...30 V Totem Pôle SSI serial or parallel absolute encoders	Modules for servomotors	2	TSX™ CAY 21C	0.480
		4	(2) TSX CAY 41C	0.610
		2	TSX CAY 22C	0.480
		4	(2) TSX CAY 42C	0.610
	200 kHz acquisition with serial absolute encoder (1)	3	(2) TSX CAY 33C	0.610

Accessories and connecting cables, see page 4/37 and 4/41.

(1) With servo control on linear or infinite axis function, follower axes and flying shear for TSX CAY ●2C modules.

(2) Double-format module, the other motion control modules are in single-format.



TSX ISP Y101C

### Weighing module

Description	Function	Reference	Weight kg
ISP Plus weighing module	1 weigher/module, 1...8 load cells	TSX™ ISP Y101C	0.420

Remote weight indicator and accessories, see pages 4/58 and 4/59.



TSX ETY ●103C/WMY 100C

### Communication

Description	Function	Reference	Weight kg	
Ethernet TCP/IP network modules	10 Mbit/s, Transparent Ready® class C10	TSX™ ETY 110WSC	0.370	
	10/100 Mbit/s, Transparent Ready class B30	TSX ETY 4103C	0.370	
	10/100 Mbit/s, Transparent Ready class C30	TSX ETY 5103C	0.370	
	10/100 Mbit/s, Transparent Ready class D10	TSX™ WMY 100C	0.370	
PCMCIA cards	CANopen Master V4.02	TSX™ CPP 110C	0.230	
	Modbus Plus™ Network 1 Mbit/s, max.64 stations	TSX™ MBP 100C	0.110	
	Serial links Modbus®, Uni-Telway™, Character mode	RS 232	TSX™ SCP 111C	0.105
		RS 485	TSX SCP 114C	0.105
	BC 20 mA	TSX SCP 112C	0.105	
Communication modules	Modbus® RS 485	TSX™ SCY 11601C	0.340	
	RS 485, 1 emplacement PCMCIA	TSX SCY 21601C	0.360	
Fieldbus modules	AS-Interface® M2E, V2 master profile	TSX™ SAY 1000C	0.340	
	INTERBUS® Master/slave 0,5 Mbit/s, generation 4	TSX™ IBY 100C	0.280	

Accessories and connecting cables, see pages 5/50...5/61 (Ethernet), 5/66...5/67 (CANopen), 5/90 and 5/91 (Modbus Plus™), 5/102 and 5/103 (Modbus®), 5/106 and 5/107 (Uni-Telway™), 5/109 (serial link), 5/69 (AS-Interface®), 5/95 (Profibus DP™) and 5/99 (INTERBUS®).



TSX MBP/SCP 1●●C

The power required to supply each TSX™ RKY rack depends on the type and number of modules installed. It is therefore necessary to create a power consumption table for each rack in order to define the most suitable TSX™ PSY power supply module for each rack. The table below can be used to calculate the consumption on the three different voltages to be supplied (≡ 5 V, ≡ 24 V, ≡ 24 VR).

**Procedure :**

- Check and choose a power supply module corresponding to the power supplies available for the 3 voltages.
- Check that the total power absorbed on these three voltages does not exceed the overall power of the power supply module.
- Values to be entered according to the type of Modicon® Premium™ PLC configuration.

Rack n°	Reference	Format S : standard D : double	Number	Consumption in mA (1)								
				Voltage ≡ 5 V		Voltage ≡ 24 VR		Voltage ≡ 24 V				
				Module	Total	Module	Total	Module	Total			
Unity™ processors with memory extension card	TSX™ P57 0244M	S	<input type="text"/>	850	<input type="text"/>							
	TSX P57 104M	S	<input type="text"/>	850	<input type="text"/>							
	TSX P57 1634M	D	<input type="text"/>	1650	<input type="text"/>							
	TSX P57 154M	S	<input type="text"/>	930	<input type="text"/>							
	TSX P57 204M	D	<input type="text"/>	850	<input type="text"/>							
	TSX P57 2634M	D	<input type="text"/>	1650	<input type="text"/>							
	TSX P57 254M	D	<input type="text"/>	930	<input type="text"/>							
	TSX™ H5724M	D	<input type="text"/>	1880	<input type="text"/>							
	TSX P57 304M	D	<input type="text"/>	1100	<input type="text"/>							
	TSX P57 3634M	D	<input type="text"/>	1900	<input type="text"/>							
	TSX P57 354M	D	<input type="text"/>	1180	<input type="text"/>							
	TSX P57 454M	D	<input type="text"/>	1680	<input type="text"/>							
	TSX P57 4634M	D	<input type="text"/>	1880	<input type="text"/>							
	TSX H5744M			<input type="text"/>	1880	<input type="text"/>						
TSX P57 554M	D	<input type="text"/>	1680	<input type="text"/>								
TSX P57 5634M	D	<input type="text"/>	1680	<input type="text"/>								
TSX P57 6634M	D	<input type="text"/>	1880	<input type="text"/>								
PL7™ processors with memory extension card	TSX P57 103M	S	<input type="text"/>	440	<input type="text"/>							
	TSX P57 153M	S	<input type="text"/>	8530	<input type="text"/>							
	TSX P57 203M	D	<input type="text"/>	750	<input type="text"/>							
	TSX P57 2623M	D	<input type="text"/>	1110	<input type="text"/>							
	TSX P57 253M	D	<input type="text"/>	820	<input type="text"/>							
	TSX P57 2823M	D	<input type="text"/>	1180	<input type="text"/>							
	TSX P57 303AM	D	<input type="text"/>	1000	<input type="text"/>							
	TSX P57 3623AM	D	<input type="text"/>	1360	<input type="text"/>							
	TSX P57 353AM	D	<input type="text"/>	1060	<input type="text"/>							
	TSX P57 353LAM	S	<input type="text"/>	1650	<input type="text"/>							
	TSX P57 453AM	D	<input type="text"/>	1080	<input type="text"/>							
	TSX P57 4823AM	D	<input type="text"/>	1440	<input type="text"/>							
	Discrete I/O	TSX™ DEY 08D2	S	<input type="text"/>	55	<input type="text"/>					80	<input type="text"/>
TSX DEY 16A2		S	<input type="text"/>	80	<input type="text"/>							
TSX DEY 16A3		S	<input type="text"/>	80	<input type="text"/>							
TSX DEY 16A4		S	<input type="text"/>	80	<input type="text"/>							
TSX DEY 16A5		S	<input type="text"/>	80	<input type="text"/>							
TSX DEY 16D2		S	<input type="text"/>	80	<input type="text"/>					135	<input type="text"/>	
TSX DEY 16D3		S	<input type="text"/>	80	<input type="text"/>					135	<input type="text"/>	
TSX DEY 16FK		S	<input type="text"/>	250	<input type="text"/>					75	<input type="text"/>	
TSX DEY 32D2K		S	<input type="text"/>	135	<input type="text"/>					160	<input type="text"/>	
TSX DEY 32D3K		S	<input type="text"/>	140	<input type="text"/>					275	<input type="text"/>	
TSX DEY 64D2K		S	<input type="text"/>	155	<input type="text"/>					315	<input type="text"/>	
TSX™ DSY 08R4D		S	<input type="text"/>	55	<input type="text"/>	80	<input type="text"/>					
TSX DSY 08R5		S	<input type="text"/>	55	<input type="text"/>	70	<input type="text"/>					
TSX DSY 08R5A		S	<input type="text"/>	55	<input type="text"/>	80	<input type="text"/>					
TSX DSY 08S5		S	<input type="text"/>	125	<input type="text"/>							
TSX DSY 08T2		S	<input type="text"/>	55	<input type="text"/>							
TSY DSY 08T22		S	<input type="text"/>	55	<input type="text"/>							
TSX DSY 08T31		S	<input type="text"/>	55	<input type="text"/>							
TSX DSY 16R5		S	<input type="text"/>	80	<input type="text"/>	135	<input type="text"/>					
TSX DSY 16S4		S	<input type="text"/>	220	<input type="text"/>							
TSX DSY 16S5		S	<input type="text"/>	220	<input type="text"/>							
TSX DSY 16T2		S	<input type="text"/>	80	<input type="text"/>							
TSX DSY 16T3		S	<input type="text"/>	80	<input type="text"/>							
TSX DSY 32T2K		S	<input type="text"/>	140	<input type="text"/>							
TSX DSY 64T2K		S	<input type="text"/>	155	<input type="text"/>							
TSX™ DMY 28FK		S	<input type="text"/>	300	<input type="text"/>					75	<input type="text"/>	
TSX DMY 28RFK		S	<input type="text"/>	300	<input type="text"/>					75	<input type="text"/>	
Bus X remote		TSX™ REY 200	S	<input type="text"/>	500	<input type="text"/>						
<b>Total</b> (carry over to page 9/7)				Current (mA)		<input type="text"/>	<input type="text"/>	<input type="text"/>	<input type="text"/>	<input type="text"/>	<input type="text"/>	



Rack n°	Reference	Format S : standard D : double	Number	Consumption (mA) (1)						
				Voltage --- 5 V		Voltage --- 24 VR		Voltage --- 24 V		
				Module	Total	Module	Total	Module	Total	
<b>Carried forward</b>		Current (mA)								
<b>Analog I/O</b>	TSX™ AEY 414	S		660						
	TSX AEY 420	S		500						
	TSX AEY 800	S		270						
	TSX AEY 810	S		475						
	TSX AEY 1600	S		270						
	TSX AEY 1614	S		300						
	TSX™ ASY 410	S		900						
	TSX ASY 800 (2)	S		200		300				
<b>Safety</b>	TSX™ PAY 262	S		150				200		
	TSX PAY 282	S		150				200		
<b>Counting, motion control and weighing</b>	TSX™ CTY 2A	S		280				30		
	TSX CTY 4A	S		330				36		
	TSX CTY 2C	S		850				15		
	TSX™ CCY 1128	S		660				15		
	TSX™ CAY 21	S		1100				15		
	TSX CAY 41	D		1500				30		
	TSX CAY 22	S		1100				15		
	TSX CAY 42	D		1500				30		
	TSX CAY 33	D		1500				30		
	TSX™ CFY 11	S		510				50		
	TSX CFY 21	S		650				100		
	TSX™ CSY 84/164	D		1800						
	TSX™ ISP Y101	S		150		145				
	<b>Communication</b>	TSX™ ETY 110 WS (3)	S		800					
		TSX ETY 110 WS (4)	S		1200					
TSX ETY 4103/5103		S		360						
TSX™ IBY 100		S		500						
TSX™ PBY 100		S		400						
TSX™ SAY 1000		S		100						
TSX™ SCY 11601		S		350						
TSX SCY 21601		S		350						
TSX™ SCP 111		-		140						
TSX SCP 112		-		120						
TSX SCP 114		-		150						
TSX™ FPP 10		-		330						
TSX FPP 20		-		330						
TSX™ MBP 100		-		220						
TSX™ CPP 110		-		60						
TSX™ P ACC 01		-		150						
<b>Terminal</b>		T FTX 117 ADJ 02	-		310					

Consumption per voltage	Total current (mA)			Total of the 3 powers
	x 5 V	x 24 VR	x 24 V	
Power (mW)		+	+	=

				Power available in mW			Overall
<b>Choice of power supply</b>	TSX™ PSY 1610	S	--- 24 V non isolated	15 000	15 000	-	30 000
	TSX PSY 2600	S	~ 100...240 V	25 000	15 000	12 000	26 000
	TSX PSY 3610	D	--- 24 V non isolated	35 000	19 000	-	50 000
	TSX PSY 5520	D	--- 24...48 V isolated	35 000	19 000	-	50 000
	TSX PSY 5500	D	~ 100...120 V ~ 200...240 V	35 000	19 000	19 000	50 000
	TSX PSY 8500	D	~ 100...120 V ~ 200...240 V	75 000	-	38 000	77 000 (5)

(1) Typical value given for 100% of inputs or outputs at state 1.  
(2) If using an external --- 24 V sensor power supply, the consumption on the --- 24 V voltage should not be included.  
(3) Without remote power supply (RJ 45).  
(4) With remote power supply (AUI).  
(5) 77,000 mW at 60 °C, 85,000 mW at 55 °C or 100,000 mW at 55 °C when using TSX™ FAN ●●P fan modules.

### Standards and certifications

Modicon® Premium™ PLCs have been developed to conform to the principal national and international standards concerning electronic equipment for industrial automation systems.

- Requirements specific to programmable controllers: functional characteristics, immunity, resistance, safety, etc.: IEC/EN 61131-2, CSA 22.2 N° 142, UL 508.
- Merchant navy requirements of the main international bodies: ABS, BV, DNV, GL, LR, RINA, RMRS, etc.
- Compliance with European Directives:
  - Low Voltage: 73/23/EEC amendment 93/68/EEC,
  - Electromagnetic Compatibility: 89/336/EEC amendments 92/31/EEC and 93/68/EEC.
- Electrical qualities and self-extinguishing capacity of insulating materials: UL 746C, UL 94.
- Hazardous areas classification: CSA 22.2 No. 213, Class I, Division 2, Groups A, B, C and D.

### Characteristics

Service conditions and recommendations relating to environment						
Temperature	Operation	° C	0...+ 60 (to IEC/EN 61131-2, + 5...+ 55) (1) 0...+ 70 with TSX FAN fan modules (1)			
	Storage	° C	-25...+ 70 (according to IEC/EN 61131-2)			
Relative humidity	Operation	%	10...95 without condensation			
	Storage	%	5...95 without condensation (according to IEC/EN 61131-2)			
Altitude		m	0...2000			
Supply voltage	Nominal voltage	V	TSX™ PSY ●610	TSX PSY 5520	TSX PSY 2600	TSX PSY ●500
			--- 24	--- 48	~ 100...240	~ 100...120 ~ 200...240
	Limit voltages		--- 19...30	--- 19...60	~ 90...264	~ 140/190...264
	Nominal frequencies	Hz	–	–	50/60	50/60
	Limit frequencies	Hz	–	–	47/63	47/63

### Protective treatment of Modicon® Premium® PLCs

Modicon® Premium™ PLCs meet the requirements of “TC” treatment (*Treatment for all Climates*).

For installations in industrial production workshops or environments corresponding to “TH” treatment (*treatment for hot and humid environments*), Premium PLCs must be embedded in envelopes with a minimum IP 54 protection, in compliance with IEC/EN 60664 and NF C20-040.

Premium™ PLCs themselves offer **protection to IP 20 level (1)**. They can therefore be installed without an envelope in reserved-access areas which do not exceed **pollution level 2** (control room with no dust-producing machine or activity). The pollution level 2 does not take account of more severe environmental conditions: air pollution by dust, smoke, corrosive or radioactive particles, vapours or salts, attack by fungi, insects, ...

If the control system needs to operate in a corrosive environment, some of them Premium modules and racks can be ordered with a conformal applied to the cover and bezel. See page 9/2.

(1) TSX P57 0244/104/154M and TSX P57 454/4634/554/5634/6634M: 0...+ 57 °C or 0...67 °C with TSX™ FAN●●P fan modules when some of them I/O modules are insert adjacent to above processors.

(2) In the case where a position is not occupied by a module, a TSX™ RKA 02 protection cover must be installed.

Environment tests		
Name of test	Standards	Levels
<b>Immunity to LF interference (CE) (1)</b>		
Voltage and frequency variation	IEC/EN 61131-2	0.85 Un/0.95 Fn for 30 minutes; 1.15 Un/1.05 Fn for 30 minutes; 0.8 Un/0.9 Fn for 5 seconds; 1.2 Un/1.1 Fn for 5 seconds
Direct voltage variation	IEC/EN 61131-2	0.85 Un...1.2 Un for 30 minutes with 5% ripple (peak values)
Harmonic 3	IEC/EN 61131-2	10 % Un; 0°/5 min...180°/5 min
Short momentary interrupt	IEC/EN 61131-2	10 ms with ~ supply; 1 ms with --- supply
Voltage shut-down/start-up	IEC/EN 61131-2	Un-0-Un; Un for 60 s; 3 cycles separated by 10 s Un-0-Un; Un for 5 s; 3 cycles separated by 1 to 5 s Un-0.9-Udl; Un for 60 s; 3 cycles separated by 1 to 5 s

Where:  
Un: nominal voltage  
Fn: nominal frequency  
Udl: detection level when powered

Name of test	Standards	Levels
<b>Immunity to HF interference. (CE) (1)</b>		
Damped oscillatory wave	IEC/EN 61000-4-12	~ / --- supply: 1kV in serial mode Discrete I/O ≥ 24V: 1 kV in serial mode
Electrical fast transient bursts	IEC/EN 61000-4-4	~ / --- supply: 2 kV in wire/common mode Discrete I/O > 48V: 2 kV in common mode; other ports: 1 kV in common mode
Surge	IEC/EN 61000-4-5	~ / --- supply: 2 kV in wire mode/1 kV in serial mode; Discrete I/O ~: 2 kV in wire mode/1 kV in serial mode; Discrete I/O ---: 2 kV in wire mode/0.5 kV in serial mode; shielded cable: 1 kV in common mode
Electrostatic discharges	IEC/EN 61000-4-2	6 kV contact, 8 kV air
Radiated electromagnetic field	IEC/EN 61000-4-3	10 V/m; 80 MHz...2 GHz Sinusoidal modulation amplitude 80 %/1 kHz
Conducted interference induced by radiated field	IEC/EN 61000-4-6	10 V/0,15 MHz...80 MHz Sinusoidal modulation amplitude 80%/1 kHz
<b>Electromagnetic emissions (CE) (1) (2)</b>		
Interference voltage	IEC/EN 61000-6-4	Class A 150 kHz...500 kHz quasi-peak 79 dB (µV); average 66 dB (µV) 500 kHz...30 MHz quasi-peak 73 dB (µV); average 60 dB (µV)
Interference field (3)	IEC/EN 61000-6-4	Class A, 10 m measurement 30 MHz...230 MHz quasi-peak 40 dB (µV); 230 MHz...1 GHz quasi-peak 47 dB (µV)

(CE): tests required by European directives CE. and based on IEC/EN 61131-2 standards.

- (1) Devices must be installed and wired in compliance with the instructions provided in the manual "Grounding and Electromagnetic Compatibility of PLC systems".pdf format on CD-ROM support included in Unity™ Pro/PL7™ software or on DVD UNY USE 909 CD M.
- (2) These tests are performed without a cabinet, with devices fixed on a metal grid and wired as per the recommendations in the manual "Grounding and Electromagnetic Compatibility of PLC systems".
- (3) In the case where the limits of electromagnetic emissions between 30 MHz and 1 GHz must be supervised, it is recommended to use the TSX™ RKY 6EX/8EX racks instead of the TSX RKY 6/8 racks.

Environment tests		
Name of test	Standards	Levels
<b>Immunity to climatic variations</b>		
Dry heat	IEC/EN 60068-2-2 Bd	60 ° C for 16 hours (D.O); 40 ° C for 16 hours (D.C)
Cold	IEC/EN 60068-2-1 Ad	0 ° C for 16 hours
Continuous humid heat	IEC/EN 60068-2-3 Ca	60 ° C with 93 % relative humidity/96 hours (D.O); 40 ° C with 93...95 % relative humidity/96 hours (D.C);
Cyclical humid heat	IEC/EN 60068-2-3 Db	[55 ° C (D.O)/40 ° C (D.O)] - 25 ° C with 93...95 % relative humidity; 2 cycles: 12 hours/12 hours
Cyclical temperature variations	IEC/EN 60068-2-14 Nb	0 ° C...60 ° C/5 cycles: 6 hours/6 hours (D.O) (1) 0 ° C...40 ° C/5 cycles: 6 hours/6 hours (D.C)
Temperature Rise	IEC/EN 61131-2/UL 508 CSA 22-2 No.142	Ambient temperature: 60 ° C
<b>Withstand to climatic variations</b>		
Dry heat (power off)	IEC/EN 60068-2-2 Bb	70 ° C for 96 hours
Cold (power off)	IEC/EN 60068-2-1 Ab	-25 ° C for 96 hours
Humid heat (power off)	IEC/EN 60068-2-30 dB	60 ° C-25 ° C with 93...95 % relative humidity; 2 cycles: 12 hours/12 hours
Heat shocks when not operational	IEC/EN 60068-2-14 Na	- 25 ° C...70 ° C; 2 cycles: 3 hours/3 hours

D.O: Device Open (device to be embedded in an envelope)  
 D.C: Device Closed (device can be installed without envelope)

(1) **TSX P57 0244/104/154M and TSX P57 454/4634/554/5634/6634M**: 0...+ 57 °C or 0...67 °C with **TSX FAN●●P** fan modules when some of then I/O modules are insert adjacent to above processors.

Environment tests		
Name of test	Standards	Levels
<b>Immunity to mechanical constraints</b>		
Sinusoidal vibrations	IEC/EN 60068-2-6 Fc	3 Hz...100 Hz/1 mm amplitude/0.7 g; endurance: fr/90 min/axis (application coefficient < 10)
	IEC/EN 60068-2-6 Fc	10...150 Hz/75 μm amplitude/1 g; endurance: 10 cycles of 1 octave/min
Shocks	IEC/EN 60068-2-27 Ea	15 g-11 ms; 3 shocks/direction/axis
<b>Withstanding mechanical constraints</b>		
Flat freefall	IEC/EN 60068-2-32 Ed	10 cm/2 falls
Controlled position freefall	IEC/EN 60068-2-31 Ec	30 ° or 10 cm/2 falls
Random freefall, equipment in packaging	IEC/EN 60068-2-32 method 1	1 m/5 falls
<b>Equipment and personnel protection (1)</b>		
Dielectric strength and insulation resistance (CE)	UL 508/CSA 22-2 No.14 IEC/EN 60950	— 24/48V supply: 1,500 V rms; ~ 100/220V supply: 2,000 V rms Discrete I/O ≥ 48 V: 500 V rms; Discrete I/O > 48 V: 2,000 V rms; > 10 MΩ
Continuity of ground(CE)	UL 508 CSA 22-2 No.142	< 0,1 Ω/30 A/2 min
Leakage current (CE)	CSA 22-2 No.142 IEC/EN 60950	< 3.5 mA fixed device
Protection offered by enclosures (CE)	CSA 22-2 No.142 IEC/EN 60950	IP 20
Withstand to impacts	CSA 22-2 No.142 IEC/EN 60950	500 g sphere: fall from 1.3 m

(CE): tests required by European directives CE. and based on IEC/EN 61131-2 standards.

(1) Devices must be installed, wired and maintained in compliance with the instructions provided in the manual "Grounding and cabling system intallation guide".

# Modicon® Premium™ automation platform

## Ethernet network infrastructure

### Presentation

The ConneXium™ Industrial Ethernet Offer is comprised of a complete family of products and tools required to build the infrastructure of an Industrial Ethernet network. The following pages provide valuable information on the proper design of a network, and identifies the components necessary to build this infrastructure.

### Office Ethernet versus Industrial Ethernet

There are three main areas of differentiation between Ethernet applications in an office environment and Ethernet applications in an Industrial environment, they are:

- Environment
- Layout (not physical layer specification)
- Performance

Contrary to the office environment and even though ISO/IEC is working on it, there are not yet clearly defined specifications for Ethernet devices targeted to Industrial applications. The specifications of what it is called Industrial Ethernet are defined by different agencies or entities based upon its nature and based upon what the automation market has traditionally used.

The environmental specifications of Industrial Ethernet devices are today defined by the traditional agencies that define the environmental specifications for standard industrial devices (UL, CSA, CE, ...).

The IEEE 802.3 defines the physical layer specifications of the Ethernet network (types of connectors, distance between devices, number of devices, ...) while the 11801 (similarly to the TIA/EIA 568B, and GENELEC EN 50173) provide installers the layout guidelines; therefore when designing and Industrial Ethernet network and selecting its infrastructure components the IEEE 802.3 rules for quantities of devices and lengths.

The performance specifications are actually being worked on by ISO/IEC.

### Ethernet 802.3 principles

The Ethernet 802.3 Link Layer is based on a collision detection mechanism (CSMA CD): every node whose information has collided on the network realizes the collision and re-sends the information.

The process of re-sending information causes delays in its propagation and could affect the application.

A collision domain is a group of Ethernet end devices interconnected by hubs or repeaters (devices that receive information and send it out to their other ports, no matter where the destination device is connected): it means that devices will be affected by collisions.

With the availability of full duplex switches (devices that receive information and send it out just through the port to which the destination device is connected) the collision domains have disappeared.

Therefore, for industrial automation applications it is strongly recommended to use in every case full duplex switches to interconnect devices. In this way the collision domains will be eliminated completely.

### Different network topologies

Next there is a description of some of the available network topologies.

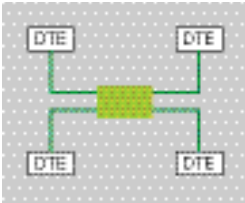

#### Star topology

In a star topology, devices are connected through an intermediate device.

#### Ethernet Star

In an Ethernet star the intermediate device may be a **hub** or a **switch**. Star is the commonly used topology in corporate networks and as of today is adopted in almost every automation application. As mentioned previously, for industrial Ethernet applications the use of full duplex switches as central device rather than hubs is strongly recommended.

#### Deploying Star topologies with ConneXium™

With any of the hubs and switches offered by the ConneXium offer, star topologies can be implemented.

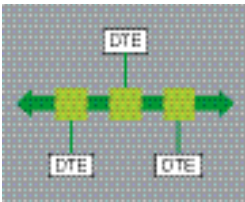

#### Bus topology

The bus is one of the most adopted topologies in traditional industrial automation networks. A single trunk cable connects the devices on the network usually via passive or active T-connectors, or directly chained (daisy chain). Devices usually can be installed anywhere along the bus.

#### Ethernet Bus

An Ethernet bus can be deployed by interconnecting **hubs** and/or **switches** in line and considering every one of them as the connection for a drop device. A limited number of hubs and an unlimited number of switches can be interconnected to achieve this purpose.

#### Deploying Bus topologies with ConneXium™

With any of the hubs and switches offered by the ConneXium offer bus topologies can be implemented. Specially suitable for this purpose are the switches with 1 or 2 fiber-optic ports. The 2 fiber-optic ports switches could be for connection of inline devices while the single fiber-optic port switches could be used for the connection of end line devices.



#### Daisy chain topology

Daisy chain -along bus- is the other most adopted topology in traditional industrial automation networks. Cable segments interconnect multiple devices, being the devices "part" of the network cable.

#### Ethernet daisy chain

Daisy chain is not today a very common Ethernet topology, but it will soon become one of the most popular ones when enough quantity of devices is made available. In Ethernet daisy chain the devices have **2 Ethernet ports** and an **embedded switch**. Schneider Electric continues to release innovative Ethernet products to the Industrial market, especially designed to connect to daisy chain architectures.

#### Deploying daisy chain topologies

To deploy daisy chain topologies, no hubs or switches are required. Devices have an embedded switch.

Dual port Ethernet at the device level is an absolute integral component for daisy chain topologies. Each device in the network has at least two Ethernet ports. One port of the device connects to one port of the neighboring device on either side of the device. These neighboring connections make up the daisy chain.

Ethernet switches can be employed in a daisy chain topology when multiple scan chains are in use by the controlling device. It is expected that the Ethernet switch will be located near the controlling device with the different scan chains emanating from the switch.

### Different network topologies (continued)

#### Daisy chain topology (continued)

##### Limitations of daisy chain:

The limitations of daisy chain technology in maintaining the operational integrity of the network and meeting performance metrics, are:

- Dual port Ethernet devices only support 10 Mbit/s and/or 100 Mbit/s operational speeds and must use one or the other.
- The network will operate only as fast as the slowest device that is connected to the network
- In order to improve network traffic latency the numbers of devices in a single scan chain, has been limited to 32 devices.
- Limiting a single scan chain to 32 devices the time for a round trip of a packet through the daisy chain is expected less than 5 milliseconds (with 32 devices plugged on a scan daisy chain).

The maximum packet latency of a packet passing through any device in a scan chain is no more than 10  $\mu$ s.

The first Schneider Electric device to be designed with Ethernet daisy chain capabilities is the Lexium® 15/17D servodrive.

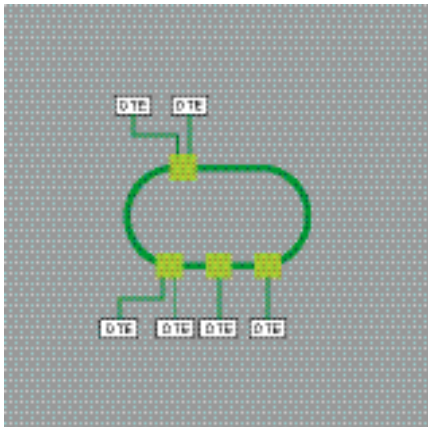

#### Ring topology

In a ring topology, devices or network infrastructure components are connected in a loop with no beginning or end. Through these types of topologies a type of network redundancy is achieved.

##### Ethernet Ring

Ethernet rings are usually the backbones of applications in which high availability is required. If ring topology is required then switches that support this feature should be ordered.

##### Deploying Ring topologies using ConneXium™

The ConneXium line offers hubs and switches that allow the deployment of single and coupled self-healing rings. There is additional information about this topic in the redundancy segment.



## Distance limitations and number of devices per segment

Based upon the 802.3, the distance limits and the numbers of devices in cascade are the following:

Type	Maximum segment length (1)	Maximum segment length (offered by ConneXium™ devices)	Maximum number of hubs in cascade	Maximum number of switches in cascade
10BASE-T	100 m	100 m	4	Unlimited
100BASE-TX	100 m	100 m	2	Unlimited
1000BASE-T	100 m	100 m	–	Unlimited
10BASE-FL	2000 m	3100 m (2)	11 (fiber ring)	–
100BASE-FX	412 m/2000 m	4000 m with multimode, 32.500 m with monomode (3)	–	Unlimited
1000BASE-SX	275 m	–	–	Unlimited

(1) Based on 802.3, full duplex/half duplex.

(2) Depends on the optical budget and fiber attenuation.

(3) Depends on the optical fiber budget and fiber attenuation, typical specification is 2 km for multimode and 15 km from monomode.

## Physical Media

The Ethernet 802.3 defines the Physical Layer. A summary of the most common media is shown below

Type	Data rate	Cable type		Connector type	
		Defined by 802.3	Recommended by Schneider Electric	Defined by 802.3	Recommended by Schneider Electric
10BASE-T	10 Mbit/s	CAT 3 - UTP	CAT 5E - STP	RJ45	RJ45
100BASE-TX	100 Mbit/s	CAT 5 - UTP	CAT 5E - STP	RJ45	RJ45
1000BASE-T	1 Gbit/s	CAT 5 - UTP	CAT 5E - STP	RJ45	RJ45
10BASE-FL	10 Mbit/s	Two multimode fiber-optic cables typically 62.5/125 µm fiber, 850 nm light wavelength	Two multimode fiber-optic cables typically 62.5/125 µm fiber, 850 nm light wavelength	ST	ST
100BASE-FX	100 Mbit/s	Two multimode optical fibers typically 62.5/125 µm multimode fiber, 1300 nm light wavelength	Two multimode optical fibers typically 62.5/125 µm multimode fiber, 1300 nm light wavelength	ST	SC
		–	Two monomode optical fibers typically 9/125 µm multimode fiber, 1300 nm light wavelength	–	SC
1000BASE-SX	1 Gbit/s	Two 62.5/125 or 50/125 multimode optical fibers, 770 to 860 nm light wavelength	Two 62.5/125 µm or 50/125 m multimode optical fibers , 1300 nm light wavelength	SC	LC
1000BASE-LX	1 Gbit/s	–	Two 9/125 µm monomode optical fibers, 1300 nm light wavelength	–	LC

**Note :** The above are the specifications defined by IEEE 802.3. However some of the cables are no longer being developed. For instance, for 10BASE-T and 100BASE-TX, a CAT-5e cable is used.

### Management

The Ethernet devices in general (end devices and the cabling devices) devices may be divided in two categories: unmanaged and managed devices:

- **The unmanaged** devices are those with no possibility to configure or control any of the parameters of the device.
- **The managed** devices are those with possibility to configure or control the parameters of the device (manage them) and to access its internal information.

The ConneXium™ product line offers both types of devices.

There is also a third category of devices not specifically defined but is important to understand the difference. These devices only allow access to its information but can not be controlled and/or configured. Usually these devices are considered in the category of managed devices.

### Managed devices

**The managed devices offer the following features:**

- **Traffic optimization and filtering**, goal is to increase the bandwidth, or the traffic capacity in a network (some of the features in this area are message and port priority, flow control, multicast filtering, broadcast limiting, IGMP snooping, Vlan, etc.).

- **VLAN**, a virtual LAN (VLAN) consists of a group of network participants in one or more network segments who can communicate with each other as if they belonged to the same LAN.

VLANs are based on logical (instead of physical) links. The biggest advantage of VLANs is their possibility of forming user groups based on the participant function and not on their physical location or medium.

Since broad/multicast data packets are transmitted exclusively within a virtual LAN, the remaining data network is unaffected. VLAN can also serve as a security mechanism to block unwanted Unicast messages.

- **Security**, feature that helps the user protect the switch from unauthorized access that could result in changes in its configuration and impact the traffic going through the switch (some of the features in this area are port security, read/write community name, etc.).

User can also set up the switch so that it blocks messages coming from unauthorized "devices" source addresses connected to the switch.

- **Time Synchronization**, feature that allows all the devices in the network to be synchronized on time.

- **Network Redundancy**, to develop high availability applications.

## Redundancy

To develop high availability applications, “redundancy” in the networking infrastructure is the answer. By implementing a single ring architecture, or a coupled ring one, can protect themselves against losses of network segments.

### Single Ring

The first level of redundancy is achieved by implementing a single ring. The ConneXium™ switches allow the set up of backbone ring configurations.

The ring is constructed using the HIPER-Ring ports. If a section of the ring network becomes inoperative, a ring **structure of up to 50 Switches** transforms back to a line-type configuration within 0.5 seconds.

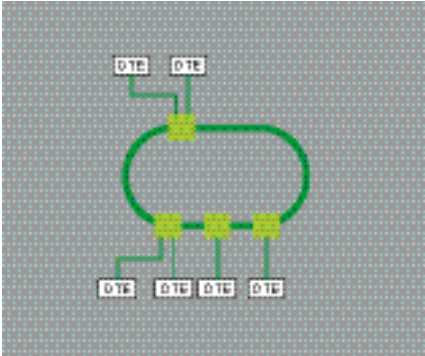

### Dual Ring

The second level of redundancy is achieved by implementing a dual ring. The control intelligence built into the ConneXium switches allows the redundant coupling of HIPER-Rings and network segments.

These configurations would double the redundancy obtained by using a single ring.

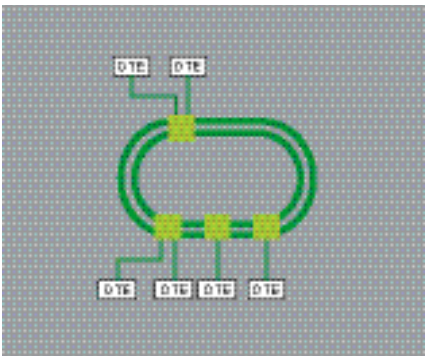

### Mesh topology using the Rapid Spanning Tree protocol

**A third level of redundancy can be achieved by implementing a mesh topology.** In simple terms spanning tree is a protocol that helps to ensure a single path for the signal, when multiple paths exist, and if the active path is broken, the spanning tree protocol enables one of the alternatives paths. ConneXium™ switches provide this needed flexibility.

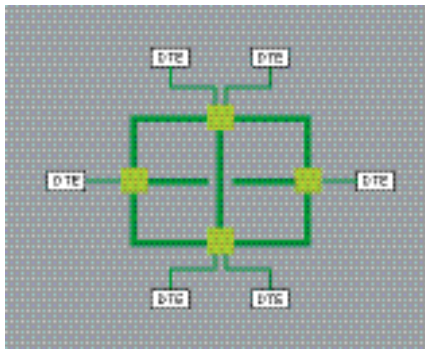

# Technical appendices

## Certifications for automation products







### EC regulations

Some countries require certain electrical components to undergo certification by law. This certification takes the form of a certificate of conformity to the relevant standards and is issued by the official body in question. Where applicable, certified devices must be labelled accordingly. Use of electrical equipment on board merchant vessels generally implies that it has gained prior approval (i.e. certification) by certain shipping classification societies.

Abbreviated name	Certification body	Country
CSA	Canadian Standards Association	Canada
C-Tick	Australian Communication Authority	Australia, New Zealand
GOST	Scientific research institute for GOST standards	CIS, Russia
UL	Underwriters Laboratories	USA
Abbreviated name	Classification society	Country
IACS	International Association of Classification Societies	International
ABS	American Bureau of Shipping	USA
BV	Bureau Veritas	France
DNV	Det Norske Veritas	Norway
GL	Germanischer Lloyd	Germany
LR	Lloyd's Register	UK
RINA	Registro Italiano Navale	Italy
RMRS	Russian Maritime Register of Shipping	CIS, Russia
RRR	Russian River Register	

The tables below provide an overview of the situation as at **01/02/2009** in terms of which certifications (listed next to their respective bodies) have been granted or are pending for our automation products. Up-to-date information on which certifications have been obtained by products bearing the Schneider Electric brand can be viewed on our website: [www.schneider-electric.com](http://www.schneider-electric.com)

### Product certifications

	Certifications						
	 UL USA	 CSA Canada	 C-Tick ACA Australia	 GOST CIS, Russia	 Hazardous locations Class I, div 2 (1) USA, Canada	 ATEX Europe	 TÜV Rheinland
Advantys™ OTB							
Advantys™ STB					FM	Cat. 3 G	
Advantys™ Telefast® ABE 7							
ConneXium™					(2)		
Magelis® iPC, Magelis® XBT GTW	(3)			(2)	UL	(2)	
Magelis® XBT GT				(2)	CSA/UL	Cat. 3 G-D	
Magelis® XBT GK					CSA		
Magelis® XBT N/R					CSA/UL	Cat. 3 G-D	
Magelis® XBT RT					CSA/UL	Cat. 3 G-D	
Modicon® M340™					CSA		
Modicon® Momentum™							
Modicon® Premium™				(2)	CSA		
Modicon® Quantum™				(2)	FM (2)		
Modicon Quantum Safety™				(2)	CSA		SIL 2 (4)
Modicon® TSX Micro™							
Phaseo®	(3) (5)						
Twido®	(6)	(6)			CSA/UL (6)		

(1) **Hazardous locations:** According to UL 1604, CSA 22.2 N° 213 and FM 3611, certified products are only approved for use in hazardous locations categorized as Class I, division 2, groups A, B, C and D, or in non-classified locations.

(2) Depends on product; please visit our website: [www.schneider-electric.com](http://www.schneider-electric.com)

(3) North American certification cULus (Canada and USA)

(4) According to IEC 61508. Certified by TÜV Rheinland for integration into a safety function of up to SIL2 level.

(5) Except for power supplies and function modules in the Universal range: UL certification pending

(6) Except for AS-Interface module TWD NOI 10M3; C€ only.

#### Specific certifications









BG	Germany	Safety module <b>TSX™ DPZ 10D2A</b> (Modicon TSX Micro) Safety modules <b>TSX™ PAY 262/282</b> (Modicon Premium)
<b>SIMTARS</b>	Australia	Modicon® TSX Micro™ automation platform Modicon® Premium™ (PL7™) automation platform
AS-Interface	Europe	Master module <b>TWD™ NOI 10M3</b> (Twido) Master module <b>TSX™ SAZ 10</b> (Modicon TSX Micro) Master modules <b>TSX™ SAY 1000</b> (Modicon Premium)

# Technical appendices

## Certifications for automation products

### EC regulations

#### Merchant navy certifications

Certified Certification pending	Shipping classification societies							
								
	ABS USA	BV France	DNV Norway	GL Germany	LR UK	RINA Italy	RMRS CIS	RRR CIS
Advantys™ OTB								
Advantys™ STB	(1)							
Advantys™ Telefast® ABE 7								
ConneXium™				(2)				
Magelis® iPC, Magelis® XBT GTW								
Magelis® XBT GT								
Magelis® XBT GK								
Magelis® XBT N/R								
Magelis® XBT RT								
Modicon® M340™	(2)	(2)	(2)	(2)	(2)	(2)		
Modicon® Momentum™								
Modicon® Premium™ (3)								
Modicon® Quantum™	(2)	(2)	(2)	(2)	(2)	(2)	(2)	
Modicon® TSX Micro™								
Phaseo®								
Twido®			(4)	(4)	(4)			

(1) Also covers US Navy requirements ABS-NRV part 4.

(2) Depends on product; please visit our website: [www.schneider-electric.com](http://www.schneider-electric.com).

(3) Modicon Premium, also certified by KRS (Korean Register of Shipping).

(4) Except for: Compact bases **TWD LC●●40DRF**. Extreme base **TWD LEDCK1**, communication modules **499 TWD 01100**, **TWD NCO1M** and **TWD NOI 10M3** and tap junctions **TWD XCA ISO/T3RJ**.

Certifications pending for I/O extension modules (discrete **TM2 D** and analog **TM2 A**).

#### EC regulations

##### European Directives

The open nature of the European markets assumes harmonization between the regulations set by different European Union member states.

European Directives are texts whose aim is to remove restrictions on free circulation of goods and which must be applied within all European Union states.

Member states are obligated to incorporate each Directive into their national legislation, while at the same time withdrawing any regulation that contradicts it. Directives - and particularly those of a technical nature with which we are concerned - merely set out the objectives to be fulfilled (referred to as "essential requirements").

The manufacturer is obligated to implement any and all measures to help ensure that its products meet the requirements of each Directive that applies to its equipment.

As a general rule, the manufacturer certifies compliance with essential requirements of the Directive(s) that apply to its product by applying a CE mark. The CE mark has been applied to our products where applicable.

##### Significance of the CE mark

- The appearance of a CE mark on a product indicates the manufacturer's certification that the product conforms to the relevant European Directives; this is a prerequisite for placing a product which is subject to the requirements of one or more Directives on the market and for allowing its free circulation within European Union states.
- The CE mark is intended for use by those responsible for regulating national markets.

Where electrical equipment is concerned, conformity to standards indicates that the product is fit for use. Only a warranty by a well-known manufacturer can provide assurance of a high level of quality.

As far as our products are concerned, one or more Directives are likely to apply in each case; in particular:

- The Low Voltage Directive (2006/95/EC)
- The Electromagnetic Compatibility Directive (2004/108/EC)
- The ATEX CE Directive (94/9/EC)

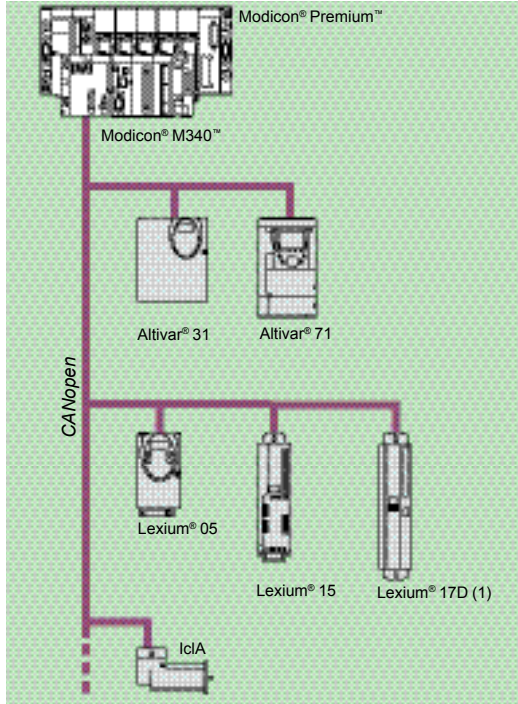

MFB: Motion control distributed over CANopen

### Presentation

MFB (Motion Function Blocks) is a library of function blocks integrated in Unity™ Pro software used to set up motion control in the architectures of drives and servo drives on machine buses and CANopen installations:

- Altivar® 31: For asynchronous motors from 0.18 to 15 kW
- Altivar® 71: For asynchronous motors from 0.37 to 500 kW
- Lexium® 05: For servo motors from 0.4 to 6 kW
- Lexium® 15LP/MP/HP: For BSH and BDH servo motors from 0.9 to 42.5 kW
- Lexium® 17D: For BPH, BPL and SER servo motors from 1.5 to 70 Arms (1)
- IclA IFA/IFE/IFS: For integrated motor drives from 0.05 to 0.25 kW

In compliance with PLCopen specifications, the MFB library allows both easy and flexible motion programming with Unity Pro™, as well as axis diagnosis. In maintenance operations, drives can be replaced quickly, thanks to drive parameter download blocks.

Setting up drives on the CANopen network is facilitated through Motion Tree Manager organization in the Unity™ Pro browser, making it easy for users to access the application drives.

### Applications

The features of the Motion Function Blocks library are particularly suitable for machines with independent axes. In the case of these modular/special machines, MFB function blocks are the perfect solution for controlling single axes. The following are typical applications for this type of architecture:

- Automatic storage/removal
- Handling
- Palletizers/depalletizers
- Conveyors
- Packaging, simple label application
- Grouping/ungrouping
- Adjustment axes in flexible machines, etc.

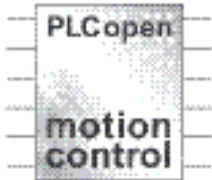

### Functions

The table below lists the function blocks of the MFB library and the drives compatible with them. The prefix indicates the block family:

- MC: Function block defined by the Motion Function Blocks PLCopen standard
- TE: Function block specific to Telemecanique products
- Lxm: Function block specific to Lexium servo drives

Type	Function	Function block	Altivar 31	Altivar 71	Lexium 05	Lexium 15 HP/MP/LP	Lexium 17D (1)	IclA IFA/IFE/IFS
Management and motion	Read an internal parameter	MC_ReadParameter						
	Write an internal parameter	MC_WriteParameter						
	Read the current position	MC_ReadActualPosition						
	Read the instantaneous speed	MC_ReadActualVelocity						
	Acknowledge error messages	MC_Reset						
	Stop active movement	MC_Stop						
	Axis coming to standstill	MC_Power						
	Movement to absolute position	MC_MoveAbsolute						
	Relative movement	MC_MoveRelative						
	Additional movement	MC_MoveAdditive						
	Homing	MC_Home						
	Movement at given speed	MC_MoveVelocity						
	Read diagnostic data	MC_ReadAxisError						
	Read servo drive status	MC_ReadStatus						
	Torque Control command	MC_TorqueControl						
Reading of actual torque value command	MC_ReadActualTorque							
Manual move command	MC_Jog				Except LP			
Save and restore parameters (FDR)	Read parameters and store in PLC memory	TE_UploadDriveParam						
	Write parameters from the PLC memory	TE_DownloadDriveParam						
Advanced Lexium® functions	Set the reduction ratio	Lxm_GearPos						
	Read a motion task	Lxm_UploadMTask						
	Write a motion task	Lxm_DownloadMTask						
	Start a motion task	Lxm_StartMTask						
System	Communication with the servo drive	TE_CAN_Handler						

Compatible

(1) Lexium® 17D supported by MFB with Modicon® Premium™ platform only.

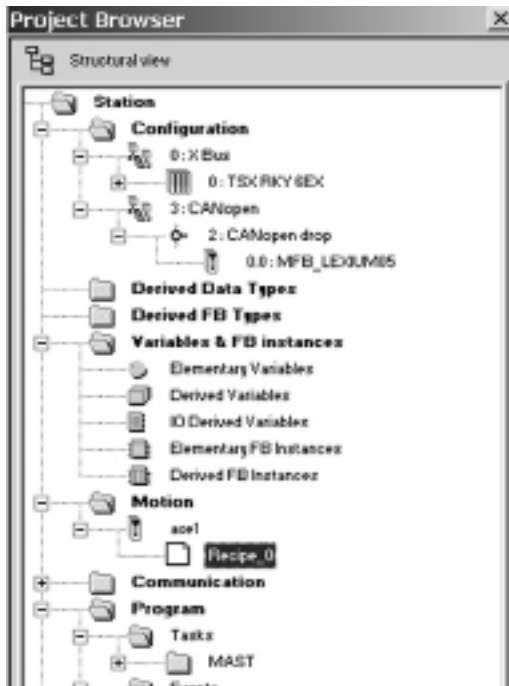

Motion Tree Manager integrated in the Unity Pro browser

### Motion Tree Manager

Motion Tree Manager is associated with the Unity™ Pro MFB library, and integrated in its browser. It provides specific assistance for:

- Axis object management
- Axis variable definition
- Drive parameter management

Motion Tree Manager automatically creates links between the CANopen bus configuration and the MFB function block data using a limited amount of configuration data.

### General axis parameters

In this tab, the designer is prompted to define:

- The name of the axis that will identify it in the browser for the entire application
- The address of the drive on the CANopen bus

### Axis parameters

The dropdown lists in this tab are used to determine the exact type of drive: including both family and version.

### Variable names

This last tab is used to identify data structures:

- **Axis\_Reference**, used by the instances of function blocks for the axis in question
- **CAN\_Handler**, used to manage communication with the drive via the CANopen network

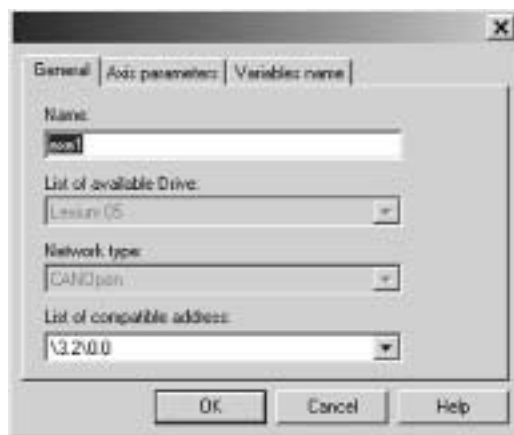

General parameters: Axis name and address

### Recipe definition

The "recipes" attached to the axis are the data structures containing the adjustment parameters of a given drive. This data is used when:

- Changing the drive with restoration of the context during "Faulty Device Replacement" maintenance
- Changing the manufacturing program of the machine, and calling up an appropriate set of parameters, such as servo control gains, limitations etc. adapted to the weight and size of the moving parts.
- Save of recipe parameters initial values in the PLC application.

### Programming, diagnostics and maintenance

Communication between the PLC and drive is automatically set up by the system as soon as a TE\_CAN\_Handler instance is declared in the Unity Pro task with which the axis is associated.

Movements are then programmed by sequencing function blocks from the library in the Unity™ Pro editor as selected by the user (LD, ST, FBD).

The two function blocks, MC\_ReadStatus, and in some cases MC\_ReadAxisError, are useful for determining the overall status of the axis, and the code of active warnings or detected errors.

The function blocks TE\_UploadDriveParam and TE\_DownloadDriveParam allow the application to save the parameters of a drive (recipe) and to then quickly reload them into another drive if the first one becomes inoperative.

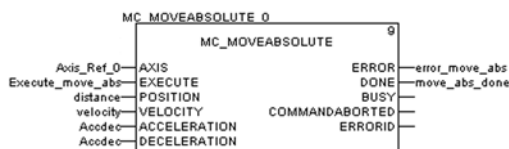

MFB: Programming a movement in absolute mode

043 509 383	5/93	ABE 7FU012	8/17	ABF Y25S200	3/27	FTX CN 3210	5/66	SYS SPU LUTCD29M	5/65
110 XCA 282 0●	6/39	ABE 7H08R●●	8/11	ABF Y25S300	3/27	FTX CN 32●0	5/66	<b>T</b>	
170 DTN 110 00	5/95	ABE 7H08S21	8/11	ABF Y25S500	3/27	FTX CNCT1	5/67	TCS AAR011M	5/73
170 INT 110 00	5/99	ABE 7H12R●●	8/11	ABL 1A02	8/31	FTX CNTL12	5/67	TCS ATN011F	5/73
170 MCI ●●●●●	5/99	ABE 7H12S21	8/11	ABL 8BBU24200	8/31	FTX CY1208	5/67	TCS ATN011F1	5/73
170 PNT 110 20	5/93	ABE 7H16CM11	8/10	ABL 8BPK24A03	8/31	FTX CY1212	5/67	TCS ATN011F2	5/73
170 XTS 0●●●00	3/41	ABE 7H16CM21	8/10	ABL 8BPK24A12	8/31	FTX DG12	5/67	TCS ATN01N2	5/73
	5/99	ABE 7H16C●●	8/10	ABL 8BUF24400	8/31	FTX DP2115	5/67	TCS ATN02V	5/73
	5/93	ABE 7H16F43	8/11	ABL 8DCC05060	8/31	FTX DP2130	5/67	TCS ATV011F1	5/73
467 NHP 811 00	5/95	ABE 7H16R●●	8/11	ABL 8DCC12020	8/31	FTX DP2150	5/67	TCS ATV011F2	5/73
490 NAA 271 0●	5/93			ABL 8FUS0●	8/31	FTX DP2206	5/67	TCS ATV01N2	5/73
490 NAD 911 0●	5/95			ABL 8PRP24100	8/31	FTX DP2210	5/67	TCS CCN 4F3M05T	5/66
490 NOC 000 05	5/51			ABL 8RED24400	8/31	FTX DP2220	5/67	TCS CCN 4F3M1T	5/66
490 NOR 000 ●●	5/51			ABL 8RPM24200	8/31	FTX DP2250	5/67	TCS CCN 4F3M3T	5/66
490 NOT 000 05	5/51			ABL 8RPS24030	8/31	FTX MLA10	5/67	TCS CTN011M11F	5/67
490 NTC 000 05	4/69	ABE 7H16S21	8/11	ABL 8RPS24050	8/31			TCS EAA F11F13F00	5/51
	5/50	ABE 7H16S21E	8/11	ABL 8RPS24100	8/31	<b>L</b>		TCS EAA F1LFH00	5/51
490 NTC 000 40●	4/69	ABE 7H16S43	8/11	ABL 8WPS24200	8/31	LAD 90	8/31	TCS EAA F1LFS00	5/51
	5/50	ABE 7H20E●00	8/10	ABL 8WPS24400	8/31			TCS EAA F1LFU00	5/51
490 NTC 000 80●	4/69	ABE 7H32E●●0	8/10	ABR 7S11	8/15	<b>O</b>		TCS EAM 0100	5/51
	5/50	ABE 7H34E●00	8/10	ABR 7S21	8/15	OZD FIP G3	5/85	TCS ECL 1M1M 1S2	5/51
490 NTW 000 02●	4/17	ABE 7LOGF25	8/17	ABR 7S23	8/15			TCS ECL 1M1M 3S2	5/51
	4/69	ABE 7LOGV10	8/17	ABR 7S33	8/15	<b>S</b>		TCS ECL 1M1M 10S2	5/51
	5/50	ABE 7P08T330●	8/14	ABR 7S33E	8/15	SF2 PY3504	4/58	TCS ECL 1M1M 25S2	5/51
490 NTW 000 05●	4/17	ABE 7P16F310●	8/13	ABR 7S37	8/15	SF3 CPY005	4/58	TCS ECL 1M1M 40S2	5/51
	5/50	ABE 7P16F312	8/13	ABS 7EA3E5	8/15	SF3 CPY010	4/58	TCS ECL 1M3M 1S2	5/51
490 NTW 000 12●	4/69	ABE 7P16●111	8/14	ABS 7EA3F5	8/15	SF3 CPY015	4/58	TCS ECL 1M3M 3S2	5/51
	5/50	ABE 7P16T21●	8/14	ABS 7EA3M5	8/15	SF3 CPY020	4/58	TCS ECL 1M3M 10S2	5/51
490 NTW 000 40●	4/69	ABE 7P16T230●	8/14	ABS 7EC3AL	8/15	SF3 CPY025	4/58	TCS ECL 1M3M 25S2	5/51
	5/50	ABE 7P16T318●	8/14	ABS 7EC3B2	8/15	SF3 CPY030	4/58	TCS ECL 1M3M 40S2	5/51
490 NTW 000 80●	4/69	ABE 7P16T330●	8/14	ABS 7EC3E2	8/15	SF3 PY32003	4/59	TCS EKN 300R2	5/50
	5/50	ABE 7P16T33●	8/14	ABS 7SA2M	8/15	SF3 PY32010	4/59	TCS EK1 MDRS	5/50
499 NEH 104 10	5/52	ABE 7R08S111●	8/12	ABS 7SA3MA	8/15	SF3 PY32020	4/59	TCS EK3 MDS	5/50
499 NES 181 00	5/54	ABE 7R08S210●	8/12	ABS 7SC1B	8/15	SF3 PY32030	4/59	TCS ESM 043F1CS0	5/57
499 NMS 251 01	5/56	ABE 7R08S216●	8/12	ABS 7SC2E	8/15	SF3 PY32040	4/59	TCS ESM 043F1CU0	5/57
499 NMS 251 02	5/56	ABE 7R16M111	8/13	ABS 7SC3BA	8/15	SF3 PY32050	4/59	TCS ESM 043F23F0	5/58
499 NSS 251 01	5/56	ABE 7R16S111●	8/12	ABS 7SC3E	8/15	SF3 PY32060	4/59	TCS ESM 043F2CS0	5/57
499 NSS 251 02	5/56	ABE 7R16S210●	8/12	AM0 2CA 001V000	5/67	SF3 PY32080	4/59	TCS ESM 043F2CU0	5/57
499 NTR 101 00	5/53	ABE 7R16S212●	8/12	AR1 SB3	8/17	SF3 PY32120	4/59	TCS ESM 083F23F0	5/58
990 MCO 000 ●●	4/53	ABE 7R16T111	8/13	AS MBKT 185	5/93	SF3 PY32200	4/59	TCS ESM 103F23G0	5/61
990 MCO 001 25	4/53	ABE 7R16T210	8/13	ASI 20MACC5	8/31	SF3 PY32300	4/59	TCS ESM 103F2LG0	5/61
990 NAA 263 ●●	5/99	ABE 7R16T212	8/13	ASI 67FACC2	5/73	SM1 PS371	4/58	TCS ESU 033FN0	5/55
	5/99	ABE 7R16T230	8/13	ASI ABLB3002	8/37	SM1 PS381	4/58	TCS ESU 043F1N0	5/55
990 NAD 211 ●●	5/93	ABE 7R16T231	8/13	ASI ABLB3004	8/37	SM1 PY52	4/58	TCS ESU 051F0	5/54
990 NAD 230 ●●	5/93	ABE 7R16T330	8/13	ASI ABLD3002	8/37	SR2 MEM02	8/31	TCS ESU 053FN0	5/55
		ABE 7R16T332	8/13	ASI ABLD3004	8/37	SSVXPSMCWINUP	4/16	TCSESM 083F1CS0	5/59
		ABE 7R16T370	8/13	ASI ABLM3024	8/37	STB NDP 2112	5/95	TCSESM 083F1CU0	5/59
<b>A</b>		ABE 7S08S2B0●	8/12	ASI RPT01	5/73	STB NIB 2212	5/99	TCSESM 083F2CS0	5/59
ABE 7ACC●●	4/69	ABE 7S08S2B1●	8/12			STB NMP 2212	5/93	TCSESM 083F2CU0	5/59
	8/17	ABE 7S16E2B1●	8/12	<b>B</b>		SYC SPU LFFCD28M	5/95	TCSESM 163F23F0	5/60
ABE 7BV10	8/17	ABE 7S16E2E0●	8/12	BMX XCA USB H0●●	6/39	SYC SPU LFGCD28M	5/95	TCSESM 163F2CU0	5/60
ABE 7BV10E	8/17	ABE 7S16E2E1●	8/12			SYC SPU LFTCD28M	5/95	TCSESM 243F2CU0	5/60
ABE 7BV20	4/23	ABE 7S16E2F0●	8/12	<b>F</b>		SYC SPU LFUCD28M	5/95	T FTX CB1 020	5/110
	4/27	ABE 7S16E2M0●	8/12	FTX BLA10	5/67	SYC SPU LRUCD28M	5/95	T FTX CB1 050	5/110
	4/31	ABE 7S16S1B2●	8/12	FTX C78B	5/67	SYC SPU LUGCD28M	5/95	TLA CD CBA 005	5/66
	4/37	ABE 7S16S2B0●	8/12	FTX C78F5	5/67	SYC SPU LUTCD28M	5/95	TLA CD CBA 015	5/66
	4/42	ABE 7TES160	3/16	FTX C78M5	5/67	SYS SPU LFFCD29M	5/65	TLA CD CBA 030	5/66
	8/17		8/17	FTX CM08B	5/67	SYS SPU LFGCD29M	5/65	TLA CD CBA 050	5/66
ABE 7BV20E	8/17	ABF C08R02B	8/17	FTX CM12B	5/67	SYS SPU LFTCD29M	5/65	TLX CD DRV20M	6/77
ABE 7CPA41●	8/16	ABF C08R12B	8/17	FTX CN 12F5	5/66	SYS SPU LFUCD29M	5/65	TLX CD FCHMI V1M	5/45
ABE 7CPA●●	3/27	ABF C08R12R	8/17	FTX CN 12M5	5/66	SYS SPU LRUCD29M	5/65	TLX CD GTW 10M	1/21
	4/8	ABF C08R12W	8/17	FTX CN 3203	5/66	SYS SPU LFFCD29M	5/65	TLX CD LFOFS 33	6/105
	4/23	ABF Y25S150	3/27	FTX CN 3206	5/66	SYS SPU LUGCD29M	5/65	TLX CD LTOFS 33	6/105
	4/27							TLX CD LUOFS 33	6/105
	4/27								
	4/31								
	4/42								
	8/16								



TLX CD PL7 DIF 42	6/83	TSX CAN CADD3	4/17	TSX CDP 053	3/16	TSX CPP 302	4/8	TSX DSY 08R4DC	9/4
TLX CD PL7J P45	6/76		5/66		4/23	TSX CRJDB 25	5/107	TSX DSY 08R5	3/15
TLX CD PL7M P45	6/76	TSX CAN CADD5	5/66		4/27	TSX CRJMD 25	1/13	TSX DSY 08R5A	3/15
TLX CD PL7M PC45	6/76		4/17		4/31		6/39	TSX DSY 08R5AC	9/4
TLX CD PL7P P45	6/77	TSX CAN CB50	5/66		4/37		6/77	TSX DSY 08R5C	9/4
TLX CD3 PL7M P45	6/76	TSX CAN CB100	5/66	TSX CDP 102	3/16		5/110	TSX DSY 08S5	3/15
TLX CD3 PL7J P45	6/76	TSX CAN CB300	5/66		4/23		5/109	TSX DSY 08T2	3/15
TLX CD3 PL7P P45	6/77	TSX CAN CBDD1	5/66		4/27	TSX CSA 100	5/103	TSX DSY 08T2C	9/4
TLX CD STOFS 33	6/105	TSX CAN CBDD3	5/66		4/31		5/107	TSX DSY 08T22	3/15
TLX CD SUOFS 33	6/105	TSX CAN CBDD5	5/66	TSX CDP 103	3/16	TSX CSA 200	5/103	TSX DSY 08T22C	9/4
TLX CD TCP50M	5/45	TSX CAN CD50	5/66		4/23	TSX CSA 500	5/103	TSX DSY 08T31	3/15
TLX CD WSBY P40E	4/74	TSX CAN CD100	5/66		4/27		5/107	TSX DSY 08T31C	9/4
TLX LIBS CNVE	5/99	TSX CAN CD300	5/66		4/31	TSX CSY 164	4/53	TSX DSY 16R5	3/15
TLX L PL7 FUZ 34M	6/81	TSX CAN KCDF 90T	5/66		4/37	TSX CSY 84	4/53	TSX DSY 16R5C	9/4
TLX L SDKC PL 741M	6/79	TSX CAN KCDF 90TP	5/66	TSX CDP 202	3/16	TSX CSY 85	4/53	TSX DSY 16S4	3/15
TLX LSDKC PL 741M	5/45	TSX CAN KCDF 180T	5/66		4/23	TSX CTC 07	5/111	TSX DSY 16S4C	9/4
TLX OS PL7 DIF 42	6/83	TSX CAN TDM4	5/66		4/27	TSX CTC 10	5/111	TSX DSY 16S5	3/15
TLX OS PL7P P45M	6/77	TSX CAP 030	3/27	TSX CDP 203	3/16	TSX CTY 2A	4/23	TSX DSY 16T2	3/15
TLX OT PL7M P45M	6/77	TSX CAP 100	3/27		4/23	TSX CTY 2AC	9/5	TSX DSY 16T2C	9/4
TLX OT PL7P P45M	6/77	TSX CAP S9	4/42		4/27	TSX CTY 2C	4/27	TSX DSY 16T3	3/15
TLX RCD3 PL7J P45M	6/76	TSX CAP S15	4/23		4/31	TSX CTY 2CC	9/5	TSX DSY 16T3C	9/4
TLX RCD3 PL7M P45	6/76		4/27		4/37	TSX CTY 2K	4/23	TSX DSY 32T2K	3/15
TLX RCD3 PL7P P45M	6/77		4/31	TSX CDP 301	3/16	TSX CTY 4A	4/23	TSX DSY 32T2KC	9/4
TLX RCD PL7J P45M	6/76		4/37		4/23	TSX CTY 4AC	9/5	TSX DSY 64T2K	3/15
TLX RCD PL7M P45	6/76		4/42		4/27	TSX CUSB 485	1/13	TSX DSY 64T2KC	9/4
TLX RCD PL7M PC45M	6/76	TSX CAY 21	4/42		4/31		4/17	TSX EEF 08D2	3/40
TLX RCD PL7P P45M	6/77	TSX CAY 21C	9/5		4/37		5/107	TSX EEF 16D2	3/40
TLX UCD3 PL7J P45M	6/76	TSX CAY 22	4/42	TSX CDP 302	3/16		5/109	TSX EF ACC 7	3/40
TLX UCD3 PL7P P45M	6/77	TSX CAY 22C	9/5		4/23		5/110	TSX EF ACC 99	3/40
TLX UCD PL7J P45M	6/76	TSX CAY 33	4/42		4/27		6/39	TSX EF ACC 2002	5/88
TLX UCD PL7P P45M	6/77	TSX CAY 33C	9/5	TSX CDP 303	3/16	TSX C USBFIP	5/88	TSX EF ACC 2010	3/41
TSC CANTDM4	4/17	TSX CAY 41	4/42		4/23	TSX CXP 213	4/43	TSX EF ACC 2030	3/41
TSX AAK2	3/27	TSX CAY 41C	9/5		4/27	TSX CXP 235	4/43	TSX EF ACC 2070	3/41
TSX ACC VA625	2/6	TSX CAY 42	4/42		4/31	TSX CXP 245	4/43	TSX EF ACC 20120	3/41
	2/10	TSX CAY 42C	9/5		4/37	TSX CXP 613	4/43	TSX EF ACC 20250	3/41
TSX AEY 414	3/26	TSX CBRY 2500	2/13	TSX CDP 501	3/16	TSX CXP 635	4/43	TSX EF CF 01	3/40
TSX AEY 414C	9/4	TSX CBRY 2500F	2/13		4/23	TSX CXP 645	4/43	TSX EF CF 02	3/40
TSX AEY 420	3/26	TSX CBRY K5	2/13		4/27	TSX DEY 08D2	3/14	TSX EF CF 03	3/40
TSX AEY 420C	9/4	TSX CBY 010K	2/10		4/31	TSX DEY 08D2C	9/4	TSX EF CM 01	3/40
TSX AEY 800	3/26	TSX CBY 030K	2/10	TSX CDP 503	3/16	TSX DEY 16A2	3/14	TSX EF CM 03	3/40
TSX AEY 800C	9/4	TSX CBY 050K	2/10		4/23	TSX DEY 16A2C	9/4	TSX EF CT 03	3/40
TSX AEY 810	3/26	TSX CBY 120K	2/10		4/27	TSX DEY 16A3	3/14	TSX EMF 16DT2	3/40
TSX AEY 810C	9/4	TSX CBY 180K	2/10		4/31	TSX DEY 16A3C	9/4	TSX ESF 08T22	3/40
TSX AEY 1600	3/26	TSX CBY 280K	2/10		4/37	TSX DEY 16A4	3/14	TSX ETC 100	5/47
TSX AEY 1600C	9/4	TSX CBY 380K	2/10	TSX CDP 611	4/43	TSX DEY 16A4C	9/4	TSX ETY 110 WS	5/45
TSX AEY 1614	3/26	TSX CBY 500K	2/10	TSX CDP 1001	3/16	TSX DEY 16A5	3/14	TSX ETY 110WSC	9/5
TSX AEY 1614C	9/4	TSX CBY 720K	2/10		4/23	TSX DEY 16A5C	9/4	TSX ETY 210	4/74
TSX ASY 410	3/26	TSX CBY 1000	2/10		4/27	TSX DEY 16D2	3/14	TSX ETY 4103	4/69
TSX ASY 410C	9/4	TSX CBY 1000K	2/10		4/31	TSX DEY 16D2C	9/4	TSX ETY 4103C	9/5
TSX ASY 800	3/26	TSX CBY ACC 10	2/10		4/37	TSX DEY 16D3	3/14	TSX ETY 5103	4/69
TSX ASY 800C	9/4	TSX CBY K9	2/10	TSX CDP 1003	3/16	TSX DEY 16D3C	9/4	TSX ETY 5103C	9/5
TSX BAT M0	1/23	TSX CCP S15	4/23		4/23	TSX DEY 16D3K	3/14	TSX FAN A4P	2/5
	1/33		4/27		4/27	TSX DEY 16FK	3/14	TSX FAN A5P	2/5
TSX BLY 01	3/16		4/31		4/31	TSX DEY 16FKC	9/4	TSX FP ACC3	5/88
	3/27		4/43		4/37	TSX DEY 32D2K	3/14	TSX FP ACC4	5/88
TSX CAN CA50	5/66	TSX CCP S15 050	4/23		4/43	TSX DEY 32D2KC	9/4	TSX FP ACC6	5/88
	4/17		4/27	TSX CFY 11	4/37	TSX DEY 32D3K	3/14	TSX FP ACC7	3/40
TSX CAN CA100	5/66		4/31	TSX CFY 11C	9/5	TSX DEY 32D3KC	9/4	TSX FP ACC8M	5/88
	4/17		4/43	TSX CFY 21	4/37	TSX DEY 64D2K	3/14	TSX FP ACC9	5/88
TSX CAN CA300	5/66	TSX CCP S15 100	4/23	TSX CPP 102	4/8	TSX DEY 64D2KC	9/4		
	4/17		4/27	TSX CPP 110	5/65	TSX DMY 28FK	3/15		
TSX CAN CADD1	5/66		4/31	TSX CPP 110C	9/5	TSX DMY 28FKC	9/4		
	4/17		4/43	TSX CPP 202	4/8	TSX DMY 28R5	3/15		
TSX CAN CADD3	4/17	TSX CCY 1128	4/31	TSX CPP 301	4/8	TSX DMY 28R5C	3/15		
	5/66	TSX CCY 1128C	9/5			TSX DSY 08R4D	3/15		
TSX CAN CADD03	4/17	TSX CD DRV 20M	5/107						

TSX FP ACC 12	3/40 5/79 5/88	TSX MFP 232P	1/32 1/33	TSX MRP P128K	1/23 1/32 1/33	TSX P57 5634M	1/13 5/44	TSX SCA 50	5/102 5/107
TSX FP ACC14	5/88	TSX MFP 264P	1/32	TSX MRP P224K	1/23 1/32 1/33	TSX P57 5634MC	9/3	TSX SCA 62	5/102 5/107
TSX FP CA 100	3/41 5/89	TSX MFP B096K	1/23 1/33	TSX MRP P384K	1/23 1/32 1/33	TSX P57 6634M	1/13 5/44	TSX SCA 72	5/102 5/107
TSX FP CA 200	3/41 5/89	TSX MFP BAK 032P	1/33			TSX P57 6634MC	9/3	TSX SCP 111	5/102 5/107 5/109
TSX FP CA 500	5/89	TSX MFP P001M	1/23 1/32 1/33	TSX P57 0244M	1/12	TSX P ACC 01	5/102 5/107 5/109	TSX SCP 111C	9/5
TSX FP CC 100	3/41 5/89	TSX MFP P002M	1/23	TSX P57 103M	1/31	TSX PAY 262	4/8	TSX SCP 112	5/102 5/107 5/109
TSX FP CC 200	3/41 5/89	TSX MFP P004M	1/23	TSX P57 103MC	9/3	TSX PAY 282	4/8	TSX SCP 112C	9/5
TSX FP CC 500	3/41 5/89	TSX MFP P128K	1/23 1/32 1/33	TSX P57 104M	1/12	TSX PBS CA 100	5/95 4/17	TSX SCP 114	5/102 5/107 5/109
TSX FP CG 010	5/81 5/83 5/89	TSX MFP P224K	1/23 1/32 1/33	TSX P57 104MC	9/3	TSX PBS CA 400	5/95 4/17	TSX SCP 114C	9/5
TSX FP CG 030	5/81 5/83 5/89	TSX MFP P384K	1/23 1/32 1/33	TSX P57 153M	1/31	TSX PBY 100	5/95	TSX SCP 114C	9/5
TSX FP CP 100	3/41 5/89	TSX MFP P384K	1/23 1/32 1/33	TSX P57 153MC	9/3	TSX P CAP	1/23 1/33	TSX SCP 114C	9/5
TSX FP CP 500	3/41 5/89	TSX MFP P512K	1/23	TSX P57 154M	1/12	TSX PCI 57 204M	1/21	TSX SCP CC 1030	5/103 5/109 5/110
TSX FP CR 100	3/41 5/89	TSX MRP 032P	1/32	TSX P57 1634M	1/12 5/44	TSX PCI 57 354M	1/21		
TSX FP CR 200	3/41 5/89	TSX MRP 064P	1/32	TSX P57 1634MC	9/3	TSX PCI ACC1	1/21	TSX SCP CD 1100	5/103 5/109 5/110
TSX FP CR 500	3/41 5/89	TSX MRP 0128P	1/32	TSX P57 203M	1/31	TSX PCX 1031	1/13 4/17 5/107 5/109 5/110	TSX SCP CM 4030	5/103 5/110
TSX FP JF020	5/89	TSX MRP 0128P	1/32	TSX P57 203MC	9/3			TSX SCP CM 4530	5/103 5/110
TSX FPP 10	5/81 5/85	TSX MRP 0256P	1/32	TSX P57 204M	1/12	TSX PCX 1130	5/111	TSX SCP CU 4030	5/107 5/110
TSX FPP 20	5/83	TSX MRP 0256P	1/32	TSX P57 204MC	9/3	TSX PLP 01	1/21 2/5	TSX SCP CU 4530	5/107 5/110
TSX FPP OZD200	5/85	TSX MRP 264P	1/32	TSX P57 253M	1/31	TSX PLP 101	1/21 2/5	TSX SCP CU 6030	5/107
TSX H57 24M	1/12 4/69	TSX MRP 0512P	1/32	TSX P57 253MC	9/3	TSX PSI 2010	1/21	TSX SCP CX 2030	5/103 5/109 5/110
TSX H57 24MC	9/3	TSX MRP 0512P	1/32	TSX P57 254M	1/12	TSX PSY 1610M	2/5	TSX SCP CX 4030	5/103 5/109 5/110
TSX H57 44M	1/13 4/69	TSX MRP 2128P	1/32	TSX P57 254MC	9/3	TSX PSY 1610MC	9/4	TSX SCY 11601	4/69 5/102
TSX IBS CA 100	5/99	TSX MRP 3256P	1/32	TSX P57 2623M	1/31 5/44	TSX PSY 2600M	2/5	TSX SCY 11601C	9/5
TSX IBS CA 400	5/99	TSX MRP 3256P	1/32	TSX P57 2623MC	9/3	TSX PSY 2600MC	9/4	TSX SCY 21601	4/69 5/83 5/102 5/107 5/109
TSX IBX 100	5/99	TSX MRP 3384P	1/32	TSX P57 2634M	1/12 5/44	TSX PSY 3610M	2/5	TSX SCY 21601C	9/5
TSX IBY 100C	9/5	TSX MRP 3384P	1/32	TSX P57 2634MC	9/3	TSX PSY 3610MC	9/4	TSX SCY CM 6030	5/103 5/109 5/111
TSX ISP Y101	4/58	TSX MRP C001M	1/23	TSX P57 2823M	1/31 5/44	TSX PSY 5500M	2/5	TSX TAP MAS	4/42
TSX ISP Y101C	9/5	TSX MRP C001M	1/23	TSX P57 2823MC	9/3	TSX PSY 5500MC	9/4	TSX TAP S15 05	4/23 4/27 4/31 4/42
TSX ISP Y121	4/58	TSX MRP C01M7	1/23	TSX P57 303AM	1/31	TSX PSY 5520M	2/5	TSX TAP S15 24	4/23 4/27 4/31
TSX MBP 100	5/93	TSX MRP C01M7	1/23	TSX P57 303AMC	1/12	TSX PSY 5520MC	9/4	TSX TLY EX	2/10 2/13
TSX MBP 100C	9/5	TSX MRP C001MC	9/3	TSX P57 304M	9/3	TSX PSY 8500M	2/5	TSX WMY 100	5/45
TSX MBP CE 002	5/93	TSX MRP C001MC	9/3	TSX P57 304MC	9/3	TSX PSY 8500MC	9/4	TSX WMY 100C	9/5
TSX MBP CE 030	5/93	TSX MRP C002M	1/23	TSX P57 353AM	1/31	TSX REY 200	2/13	TSX XBT N410	4/58
TSX MBP CE 060	5/93	TSX MRP C002M	1/23	TSX P57 353AMC	9/3	TSX RKA 02	2/6 2/10	TWD XCA ISO	5/102
TSX MCP C002M	1/23	TSX MRP C003M	1/23	TSX P57 354M	1/12	TSX RKY 4EX	2/10	TWD XCA RJ003	5/103
TSX MCP C224K	1/23 1/32 1/33	TSX MRP C003M	1/23	TSX P57 354MC	9/3	TSX RKY 4EXC	9/3	TWD XCA RJ010	5/103
TSX MCP C512K	1/23	TSX MRP C007M	1/23	TSX P57 3623AM	1/31 5/44	TSX RKY 6	2/6	TWD XCA RJ030	5/103
TSX MFP 032P	1/32 1/33	TSX MRP C007M	1/23	TSX P57 3623AMC	9/3	TSX RKY 6C	9/3		
TSX MFP 064P	1/32 1/33	TSX MRP C007MC	9/3	TSX P57 3634M	1/12 5/44	TSX RKY 6EX	2/10		
TSX MFP 064P2	1/32 1/33	TSX MRP C007MC	9/3	TSX P57 3634MC	9/3	TSX RKY 6EXC	9/3		
TSX MFP 0128P	1/32 1/33	TSX MRP C448K	1/23	TSX P57 453AM	1/31	TSX RKY 8	2/6		
TSX MFP 0128P2	1/32 1/33	TSX MRP C448K	1/23	TSX P57 453AMC	9/3	TSX RKY 8C	9/3		
		TSX MRP C768K	1/23	TSX P57 454M	1/13	TSX RKY 8EX	2/10		
		TSX MRP C768K	1/23	TSX P57 454MC	9/3	TSX RKY 8EXC	9/3		
		TSX MRP DS 2048P	1/32 1/33	TSX P57 4634M	1/13 5/44	TSX RKY 12	2/6		
		TSX MRP F004M	1/32	TSX P57 4634MC	9/3	TSX RKY 12C	9/3		
		TSX MRP F008M	1/23	TSX P57 4823AM	1/31 5/44	TSX RKY 12EX	2/10		
				TSX P57 4823AMC	9/3	TSX RKY 12EXC	9/3		
				TSX P57 554M	1/13	TSX SAY 1000	5/69		
				TSX P57 554MC	9/3	TSX SAY 1000C	9/5		
						TSX SCA 10	5/102		

## U

UAG SBT XFT CD10	6/51
UAG SEW LFF CD30	6/51
UAG SEW LFU CD30	6/51
UNY SDU DFU CD20	6/47
UNY SDU MFF CD20	6/45
UNY SDU MFT CD20	6/45
UNY SDU MFU CD20	6/45
UNY SPU EFF CD 40	6/37
UNY SPU EFG CD 40	6/37
UNY SPU EFT CD 40	6/37
UNY SPU EFU CD 40	6/37
UNY SPU EZF CD 40	6/37
UNY SPU EZG CD 40	6/37
UNY SPU EZGT CD 40	6/37
UNY SPU EZSG CD 40	6/37
UNY SPU EZST CD 40	6/37
UNY SPU EZSU CD 40	6/37
UNY SPU EZT CD 40	6/37
UNY SPU EZU CD 40	6/37
UNY SPU EZUG CD 40	6/37
UNY SPU LFF CD 40	6/37
UNY SPU LFG CD 40	6/37
UNY SPU LFT CD 40	6/37
UNY SPU LFU CD 40	6/37
UNY SPU LZF CD 40	6/37
UNY SPU LZG CD 40	6/37
UNY SPU LZGT CD 40	6/37
UNY SPU LZSG CD 40	6/37
UNY SPU LZST CD 40	6/37
UNY SPU LZSU CD 40	6/37
UNY SPU LZT CD 40	6/37
UNY SPU LZU CD 40	6/37
UNY SPU LZUG CD 40	6/37
UNY SPU MFG CD 40	6/36
UNY SPU MFT CD 40	6/36
UNY SPU MFU CD 40	6/36
UNY SPU MZG CD 40	6/36
UNY SPU MZGT CD 40	6/36
UNY SPU MZSG CD 40	6/36
UNY SPU MZST CD 40	6/36
UNY SPU MZSU CD 40	6/36
UNY SPU MZT CD 40	6/36
UNY SPU MZU CD 40	6/36
UNY SPU MZUG CD 40	6/36
UNY SPU SFG CD 40	6/36
UNY SPU SFT CD 40	6/36
UNY SPU SFU CD 40	6/36
UNY SPU SZG CD 40	6/36
UNY SPU SZGT CD 40	6/36
UNY SPU SZT CD 40	6/36
UNY SPU SZU CD 40	6/36
UNY SPU SZUG CD 40	6/36
UNY SPU XFF CD 31	6/38
UNY SPU XFG CD 31	6/38
UNY SPU XFT CD 31	6/38
UNY SPU XFU CD 31	6/38
UNY SPU XZF CD 31	6/38
UNY SPU XZG CD 31	6/38

UNY SPU XZT CD 31	6/38
UNY SPU XZU CD 31	6/38
UNY SPU ZFU CD 20E	5/45
UNY SPU ZFU CD 30E	6/41
UNY UDE VFU CD 21E	6/38
UNY USE 909 CD M	6/39
UNY XCA USB 033	1/13
	6/39
<b>V</b>	
VJC 1011 10	6/95
VJC 1011 10 11	6/95
VJC 1011 11	6/95
VJC 1011 11 12	6/95
VJC 1011 12	6/95
VJC 1011 12 13	6/95
VJC 1011 13	6/95
VJC 1011 13 14	6/95
VJC 1011 14	6/95
VJC 1011 14 15	6/95
VJC 1011 15	6/95
VJC 1011 15 99	6/95
VJC 1011 99	6/95
VJC 1020 10	6/96
VJC 1020 10 11	6/98
VJC 1020 11	6/96
VJC 1020 11 12	6/98
VJC 1020 12	6/96
VJC 1020 12 13	6/98
VJC 1020 13	6/96
VJC 1020 13 14	6/98
VJC 1020 14	6/96
VJC 1020 14 15	6/98
VJC 1020 15	6/96
VJC 1020 15 99	6/98
VJC 1020 88	6/96
VJC 1020 99	6/96
VJC 1022 10	6/97
VJC 1022 10 11	6/98
VJC 1022 11	6/97
VJC 1022 11 12	6/98
VJC 1022 12	6/97
VJC 1022 12 13	6/98
VJC 1022 13	6/97
VJC 1022 13 14	6/98
VJC 1022 14	6/97
VJC 1022 14 15	6/98
VJC 1022 15	6/97
VJC 1022 15 99	6/98
VJC 1022 88	6/97
VJC 1022 99	6/97
VJC 1030 10	6/96
VJC 1030 10 11	6/98
VJC 1030 11 12	6/98
VJC 1030 12 13	6/98
VJC 1030 13 14	6/98
VJC 1030 14 15	6/98
VJC 1030 15 99	6/98
VJC 1030 88	6/96
VJC 1030 99	6/96
VJC 1032 10	6/97
VJC 1032 10 11	6/98
VJC 1032 11 12	6/98
VJC 1032 12 13	6/98

VJC 1032 13 14	6/98
VJC 1032 14 15	6/98
VJC 1032 15 99	6/98
VJC 1032 88	6/97
VJC 1032 99	6/97
VJC 1090 88	6/99
VJC 1091 01	6/99
VJC 1091 01D3	6/99
VJC 1094 00	6/99
VJC 1095 03	6/99
VJC 1099 11	6/94
VJC 1099 12	6/94
VJC 1099 21	6/94
VJC 1099 22	6/94
VJC 3011 27	6/94
VJC 3011 50	6/94
VJC 3011 59	6/94
VJC 3051 40	6/99
VJC 3051 41	6/99
VJC 3051 42	6/99
VJC 3051 44	6/99
VJC 3051 48	6/99
VJC 3051 49	6/99
VJC L27 F12	6/94
VJC L27 L59	6/94
VJC L50 F13	6/94
VJC L59 F13	6/94
VJC L59 L50	6/94
VW3 A8 306 R30	4/17
VW3 CAN A71	5/67
VW3 CAN CARR1	5/67
VW3 CAN CARR03	5/67
VW3 CAN KCDF 180T	5/67
VW3 CAN TAP2	5/66
VW3 M8 204 R05	4/37
VW3 M38 05 R010	5/66
VW3 M8 204 R15	4/37
VW3 M8 204 R30	4/37
VW3 M8 204 R50	4/37
<b>X</b>	
XBT Z968	5/111
XBT Z9681	5/111
XPS MC16Z	4/16
XPS MC16ZC	4/16
XPS MC16ZP	4/16
XPS MC32Z	4/16
XPS MC32ZC	4/16
XPS MC32ZP	4/16
XPS MCCPC	4/17
XPS MCSCY	4/17
XPS MCTC16	4/16
XPS MCTC32	4/16
XPS MCTS16	4/16
XPS MCTS32	4/16
XPS MCWIN	4/16
XZ CB 10201	5/69
	5/73
XZ CB10201H	5/73
XZ CB10202	5/73
XZ CB10202H	5/73
XZ CB 10501	5/69
	5/73

XZ CB10501H	5/73
XZ CB10502	5/73
XZ CB10502H	5/73
XZ CB 11001	5/69
	5/73
XZ CB11001H	5/73
XZ CB11002	5/73
XZ CB11002H	5/73
XZ CC12FCM50B	5/51
	5/54
	5/67
XZ CC12FDM50B	5/51
	5/54
	5/67
XZ CC12MCM50B	5/67
XZ CC12MDM50B	5/67
XZ LG10●	3/41
XZC P1164L●	5/51
XZC P1164L●	5/51
XZ LG10●	3/41