

# HS7A-DMC Non-contact Interlock Switches

**Compact size and easy positioning.**

**Combination with proprietary relay modules achieves safety category 4 (EN954-1).**

- Compact size (7 × 16 × 51mm)
- Positioning for installation is easy.
- Up to 36 sets can be connected. (safety relay module: HR1S-DME)
- Degree of protection: IP67



- The HS7A-DMC non-contact interlock switches can be used as interlock switches when used in combination with safety relay modules specified by IDEC.

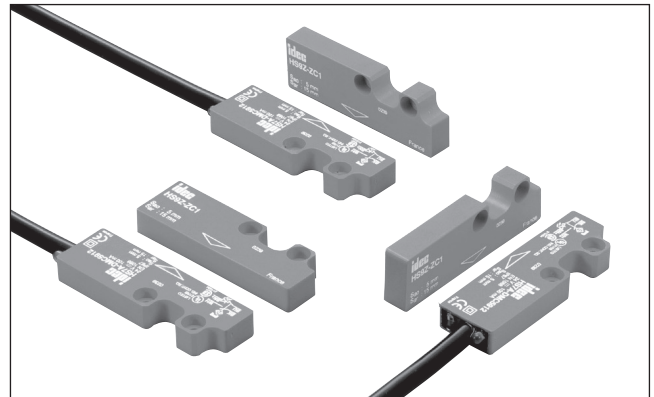

## Types

### • HS7A Non-contact Interlock Switches

Contact Configuration	Cable Length	LED	Ordering Type No.	Applicable Safety Relay Module
1NO+1NC	2m	Without	HS7A-DMC5902	HR1S-DMB1132 HR1S-DMB1132P HR1S-DME1132 HR1S-DME1132P
		With	HS7A-DMC5912	
	5m	Without	HS7A-DMC5905	
		With	HS7A-DMC5915	
	10m	Without	HS7A-DMC59010	
		With	HS7A-DMC59110	
2NO	2m	Without	HS7A-DMC7902	HR1S-AF5130B HR1S-AF5130PB
		With	HS7A-DMC7912	
	5m	Without	HS7A-DMC7905	
		With	HS7A-DMC7915	
	10m	Without	HS7A-DMC79010	
		With	HS7A-DMC79110	

- Package quantity: 1
- The HS7A-DMC non-contact interlock switch is supplied with an HS9Z-ZC1 actuator.
- The contact configuration in the table above shows the contact status when the non-contact interlock switch is not activated.

### • HR1S Safety Relay Modules for Non-contact Interlock Switches

Safety Relay Module	Number of Inputs	Max. Number of Connectable Non-contact Interlock Switches
HR1S-DMB1132	2	12
HR1S-DMB1132P		
HR1S-DME1132	6	36
HR1S-DME1132P		
HR1S-AF5130B	1	6
HR1S-AF5130PB		

- Safety category 3 can be achieved when connecting two or more non-contact interlock switches per one input.
- When connecting multiple non-contact interlock switches (HS7A-DMC790□), use HR1S-AF5130B/AF5130PB. (HS7A-DMC791□ cannot be connected in multiple numbers.)

### • Maximum Number of Connectable Non-contact Interlock Switches per Input of Safety Relay Module

Non-contact Interlock Switch	HS7A-DMC59□□		HS7A-DMC79□□	
	Without LED	With LED	Without LED	With LED
HR1S-DMB/DME	6	3	—	—
HR1S-AF5130B/AF5130PB	—	—	6	1

### • Accessory

Name	Ordering Type No.
Actuator	HS9Z-ZC1

- One HS9Z-ZC1 is supplied with each HS7A-DMC non-contact interlock switch.

## Specifications

Applicable Standards	UL508 (UL listed) CSA C22.2, No. 14 IEC/EN 60947-5-1 IEC/EN 60947-5-2 IEC/EN 60947-5-3	
Operating Temperature	-25 to 85°C (no freezing)	
Relative Humidity	30 to 85% (no condensation)	
Storage Temperature	-40 to +85°C (no freezing)	
Pollution Degree	3	
Electric Shock Protection	Class II (IEC 60536)	
Degree of Protection	IP67 (IEC 60529)	
Shock Resistance	300 m/s <sup>2</sup> (11 ms) (IEC 60068-2-7)	
Vibration Resistance	100 m/s <sup>2</sup> (10 to 150 Hz) (IEC 60068-2-6)	
Rated Voltage (Ue)	24V DC	
Rated Current (Ie)	100 mA	
Repeat Accuracy	10% maximum	
Hysteresis	20% maximum	
Maximum Operating Frequency	150 Hz	
Voltage Drop	I = 10 mA	0.1V (without LED) / 2.4V (with LED)
	I = 100 mA	1V (without LED) / 4.2V (with LED)
Housing Material	PBT	
Housing Color	Red	
Cable	AWG23 (0.25 mm <sup>2</sup> ) × 4 Cable length: 2m, 5m, 10m	
Weight (approx.)	HS7A-DMC: 100g (cable length: 2m) HS9Z-ZC1: 9g	

## Dimensions

### • HS7A-DMC (Non-contact Interlock Switch)

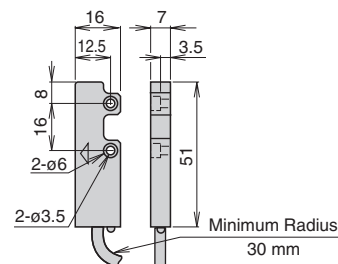

### • HS9Z-ZC1 (Actuator)

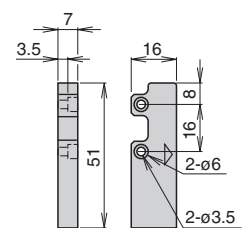

All dimensions in mm.

Flush Silhouette

Control Units

Display Lights

Display Units

Safety Products

Terminal Blocks

Comm Terminals

AS-Interface

Relays & Timers

Sockets

Circuit Protectors

Power Supplies

PLCs & SmartRelay

Operator Interfaces

Sensors

Control Stations

Explosion Protection

References

# HS7A-DMC Non-contact Interlock Switches

## Wiring Diagram

⚠ The following diagrams show the contact statuses when the non-contact interlock switches are activated by the actuators.

### • Safety Category 4 (EN 954-1) Circuit, HR1S-DMB + HS7A-DMC591 (1NO+1NC) + HS9Z-ZC1

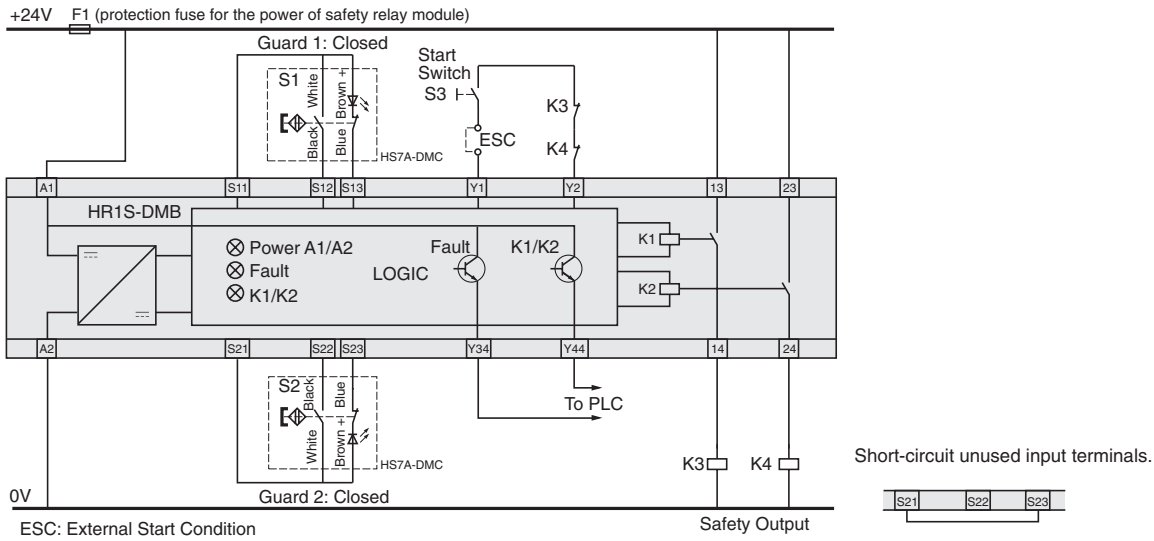

### • Safety Category 4 (EN 954-1) Circuit, HR1S-DME + HS7A-DMC591 (1NO+1NC) + HS9Z-ZC1

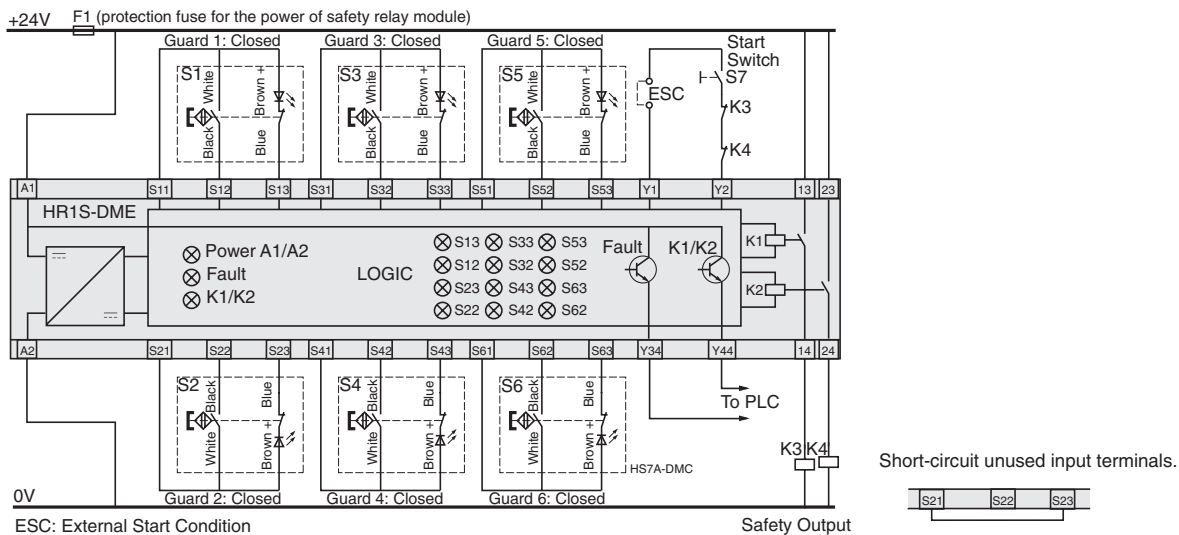

### • Safety Category 4 (EN 954-1) Circuit, HR1S-AF5130B/AF5130PB + HS7A-DMC791 (2NO) + HS9Z-ZC1 (Note)

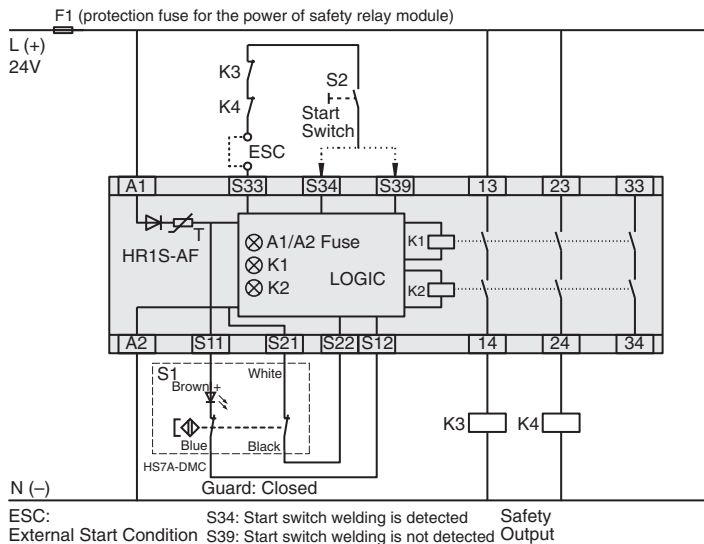

Note: The circuit example shown on the left (HR1S-AF and HS7A-DMC791\*\*) may not conform to safety category 4 depending on the operating conditions, such as the frequency of safety function check. Perform risk assessment of your system before operation.

# HS7A-DMC Non-contact Interlock Switches

• Safety category 3 (EN 954-1)  
HR1S-DMB + HS7A-DMC591 (1NO+1NC) + HS9Z-ZC1

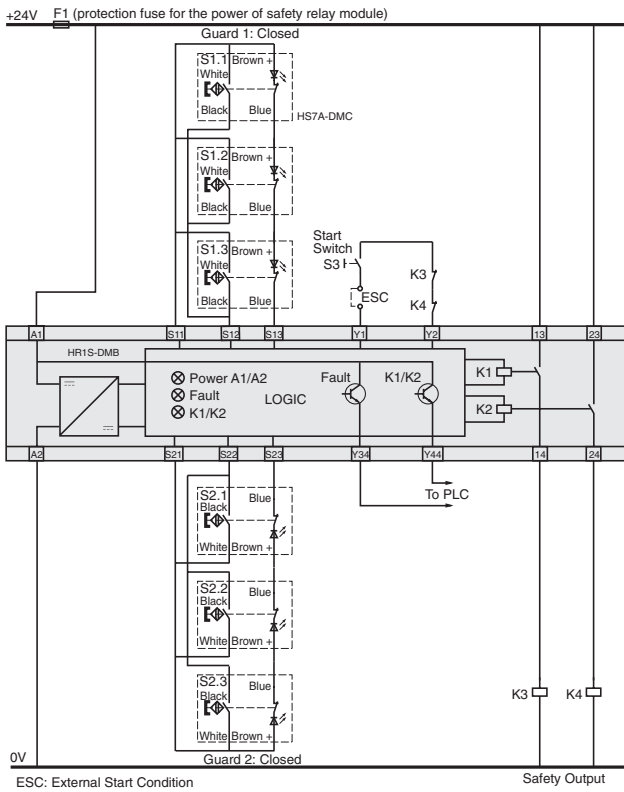

Short-circuit unused input terminals.

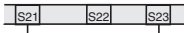

• Safety category 3 (EN 954-1)  
HR1S-DME + HS7A-DMC591 (1NO+1NC) + HS9Z-ZC1

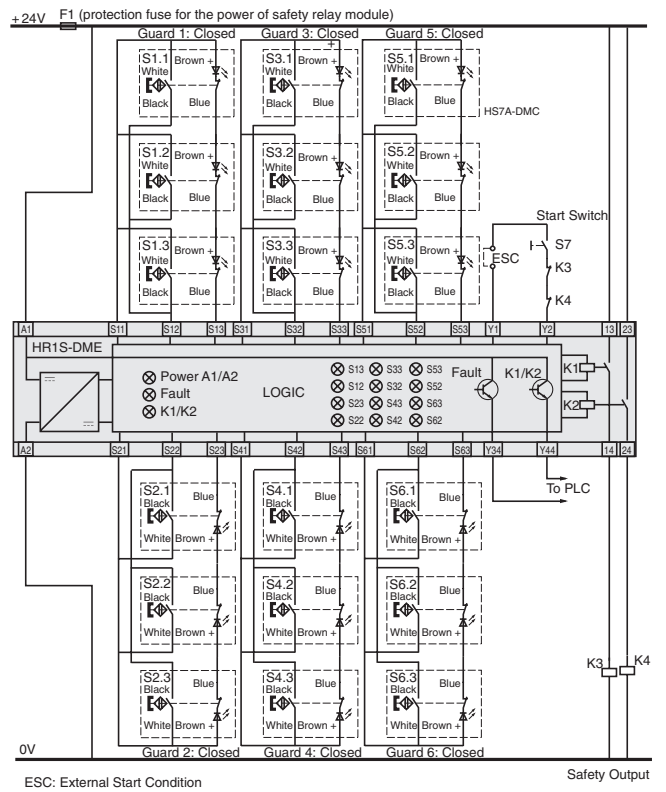

Short-circuit unused input terminals.

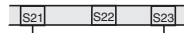

• Safety category 3 (EN 954-1)  
HR1S-AF5130B/AF5130PB + HS7A-DMC790 (2NO) + HS9Z-ZC1

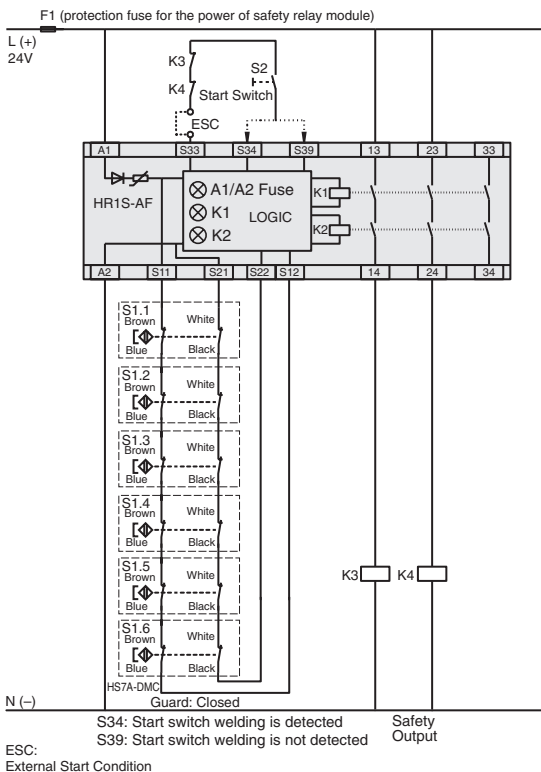

Flush Silhouette
Control Units
Display Lights
Display Units
Safety Products
Terminal Blocks
Comm Terminals
AS-Interface
Relays & Timers
Sockets
Circuit Protectors
Power Supplies
PLCs & SmartRelay
Operator Interfaces
Sensors
Control Stations
Explosion Protection
References

# HS7A-DMC Non-contact Interlock Switches

## Safety Precautions

- In order to avoid electric shock or fire, turn power off before installation, removal, wire connection, maintenance, or inspection of the non-contact interlock switch.
- Do not install the actuator in the location where the human body may come in contact. Otherwise injury may occur.

## Instructions

- Safety category 4 (EN954-1) can be achieved by combining the HS7A non-contact interlock switch and HR1S safety relay module (monitor the dual contacts using the safety relay module).
- When using non-contact interlock switches, combine with a proprietary safety relay module and confirm that the conformable safety category and the safety category (EN954-1) required to the machinery have been achieved.
- Be sure to use the HS7A non-contact interlock switch in combination with the proprietary actuator HS9Z-ZC1. Do not use other actuators.
- Regardless of door types, do not use the non-contact interlock switch as a door stop. Install a mechanical door stop on the edge of the door to protect the interlock switch against excessive force.
- A shock to the door exceeding 300 m/s<sup>2</sup> (approx. 30G) may cause a failure to the switch.
- Do not store the non-contact interlock switches in a dusty, humid, organic-gas atmosphere, or areas subject to direct sunlight.

### Operating Direction

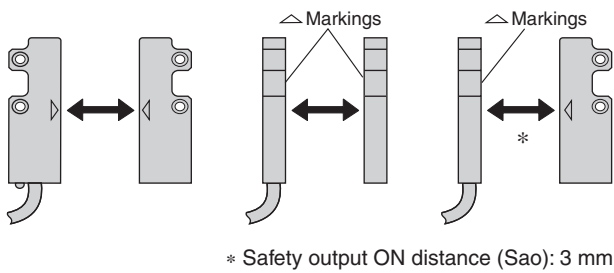

### Precautions for Installation

When installing on a ferromagnet

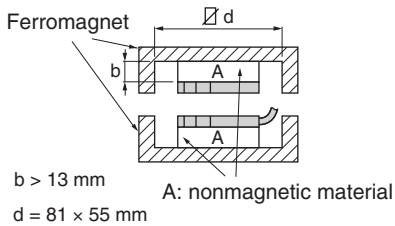

Close mounting

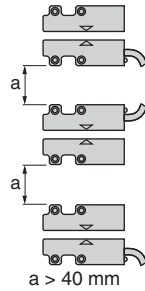

### Tightening Torque

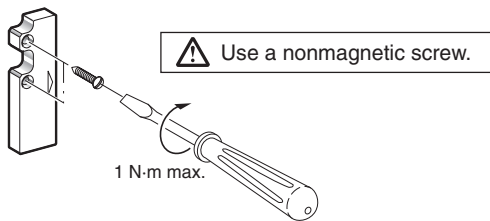

### Precaution for Cable Wiring

- ⚠ Tensile force on the cable may cause disconnection. Be sure to secure the cable near the non-contact interlock switches.

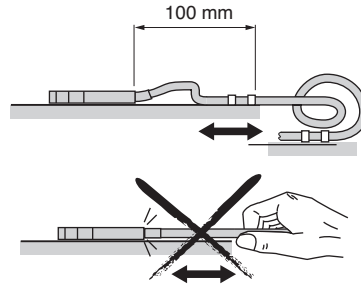

### Precautions for Mounting the Actuator

- ⚠ Do not use the non-contact interlock switch as a mechanical stop for movable guard.
- ⚠ Do not use a hammer to adjust a position of the non-contact interlock switch.

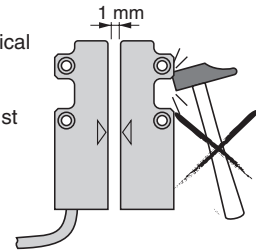

- ⚠ Do not use the non-contact interlock switch in a magnetic field of 0.3 mT or over.

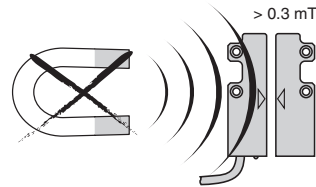

### Operation Chart

HS7A-DMC59□□(1NO+1NC)

HS7A-DMC79□□(2NO)

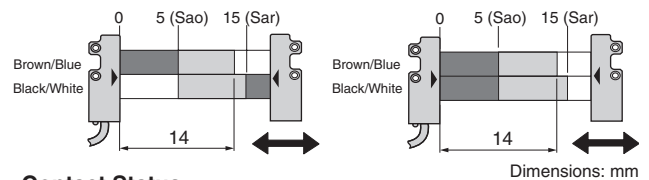

#### • Contact Status

■	Contact Closed (1)
□	Contact Open (0)
▨	Transient State

Sao: Assured operating distance where the safety output is sure to turn on.  
Sar: Assured release distance where the safety output is sure to turn off.

Note: When the transfer time between the actuator's Sao-Sar is 500 ms or longer, the time lag is detected as an error.

#### • Operation Area

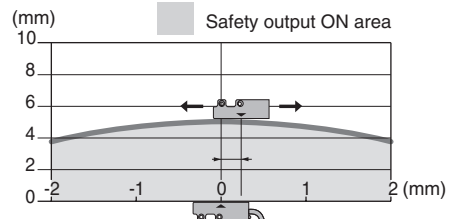

# HS7A-DMP Non-contact Interlock Switches

**Three-contact type newly added.**  
**Auxiliary contacts enable PLCs to monitor the door status.**

- Operation signals from auxiliary contacts can be read directly by controllers such as PLCs, allowing for monitoring HS7A-DMP non-contact interlock switches.
- Ideal for installation on guard doors where positioning is difficult.
- Conformable up to safety category 4 (EN954-1) (Combining with proprietary safety relay module achieves safety category 4.)
- A maximum of 36 sets can be connected (safety relay module: HR1S-DME)
- Degree of protection: IP67



• The HS7A-DMP non-contact interlock switches can be used as interlock switches when used in combination with safety relay modules specified by IDEC.

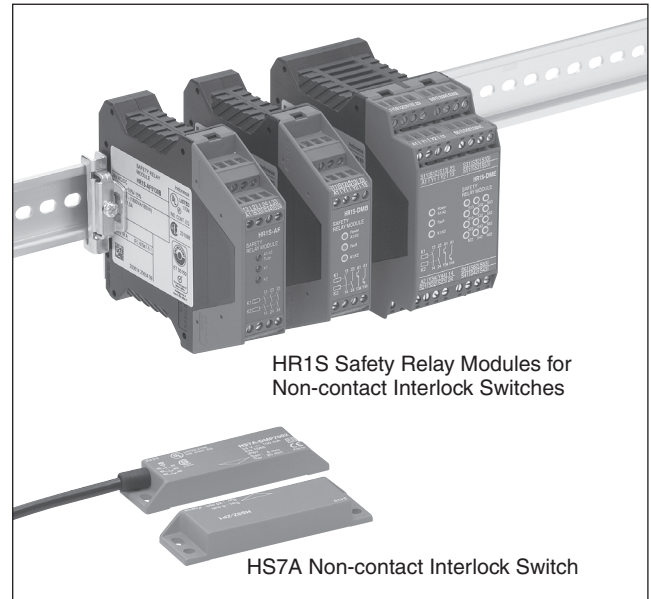

HR1S Safety Relay Modules for Non-contact Interlock Switches

HS7A Non-contact Interlock Switch

## Types

### • HS7A Non-contact Interlock Switches

Contact Configuration	Cable Length	LED	Ordering Type No.	Applicable Safety Relay Module
1NO+2NC	2m	Without	HS7A-DMP5002	HR1S-DMB1132
		With	HS7A-DMP5012	HR1S-DMB1132P
	5m	Without	HS7A-DMP5005	HR1S-DME1132
		With	HS7A-DMP5015	HR1S-DME1132P
2NO+1NC	2m	Without	HS7A-DMP7002	HR1S-AF5130B
		With	HS7A-DMP7012	
	5m	Without	HS7A-DMP7005	HR1S-AF5130PB
		With	HS7A-DMP7015	

- Package quantity: 1
- The HS7A-DMP non-contact interlock switch is supplied with an HS9Z-ZP1 actuator.
- The contact configuration in the table shows the contact status when the non-contact interlock switch is not activated.

### • HR1S Safety Relay Module for Non-contact Interlock Switches

Safety Relay Module	Number of Inputs	Max. Number of Connectable Non-contact Interlock Switches
HR1S-DMB1132	2	12
HR1S-DMB1132P		
HR1S-DME1132	6	36
HR1S-DME1132P		
HR1S-AF5130B	1	6
HR1S-AF5130PB		

- When connecting multiple non-contact interlock switches (HS7A-DMP700□), use HR1S-AF5130B/AF5130PB. (HS7A-DMP701□ cannot be connected in multiple numbers.)

### • Maximum Number of Connectable Non-contact Interlock Switches per Input of Safety Relay Module

Non-contact Interlock Switch	HS7A-DMP50□□		HS7A-DMP70□□	
	Without LED	With LED	Without LED	With LED
HR1S-DMB/DME	6	3	—	—
HR1S-AF5130B/AF5130PB	—	—	6	1

### • Accessory

Name	Ordering Type No.
Actuator	HS9Z-ZP1

- One HS9Z-ZP1 is supplied with the HS7A-DMP non-contact interlock switch.

## Specifications

Applicable Standards	UL508 (UL listed) CSA C22.2, No. 14 IEC/EN 60947-5-1 IEC/EN 60947-5-2 IEC/EN 60947-5-3	
Operating Temperature	-25 to 85°C (no freezing)	
Relative Humidity	35 to 85% (no condensation)	
Storage Temperature	-40 to +85°C (no freezing)	
Pollution Degree	3	
Electric Shock Protection	Class II (IEC 60536)	
Degree of Protection	IP67 (IEC 60529)	
Shock Resistance	300 m/s <sup>2</sup> (11 ms) (IEC 60068-2-7)	
Vibration Resistance	100 m/s <sup>2</sup> (10 to 150 Hz) (IEC 60068-2-6)	
Rated Voltage (Ue)	24V DC	
Rated Current (Ie)	100 mA	
Repeat Accuracy	10% maximum	
Hysteresis	20% maximum	
Maximum Operating Frequency	150 Hz	
Voltage Drop	I = 10 mA	0.1V (without LED), 2.4V (with LED)
	I = 100 mA	1V (without LED), 4.2V (with LED)
Housing Material	PBT	
Housing Color	Red	
Cable	AWG23 (0.25 mm <sup>2</sup> ) × 6 Cable length: 2m, 5m	
Weight (approx.)	HS7A-DMP: 180g (cable length: 2 m) HS9Z-ZP1: 50g	

## Dimensions

### • HS7A-DMP□□□□ (Non-contact Interlock Switch)

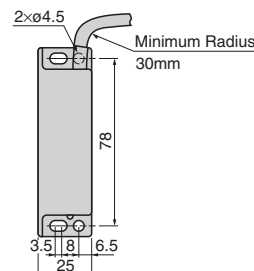

### • HS9Z-ZP1 (Actuator)

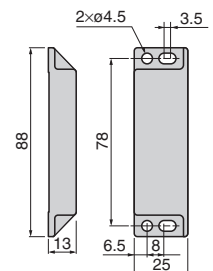

All dimensions in mm.

# HS7A-DMP Non-contact Interlock Switches

## Wiring Diagram

⚠ The following diagrams show the contact statuses when the non-contact interlock switches are activated by the actuators.

### Safety Category 4 (EN 954-1) Circuit

HR1S-DMB + HS7A-DMP50□□ (1NO+2NC) + HS9Z-ZP1

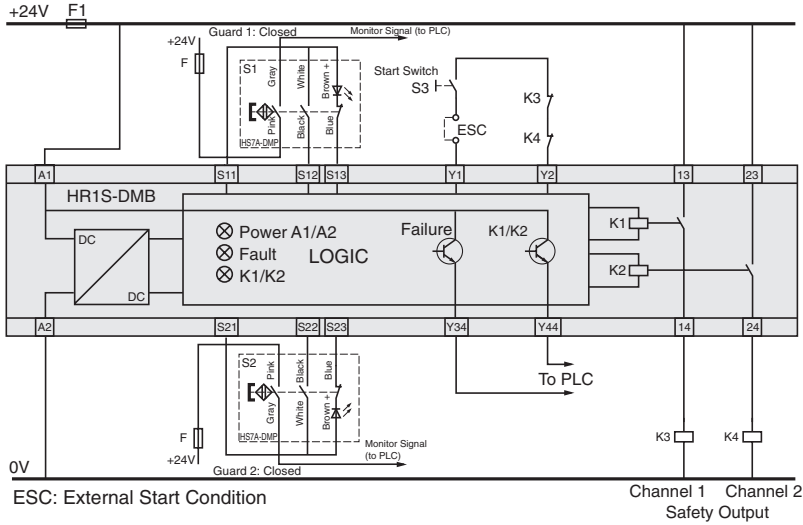

### Safety Category 3 (EN 954-1) Circuit HR1S-DMB

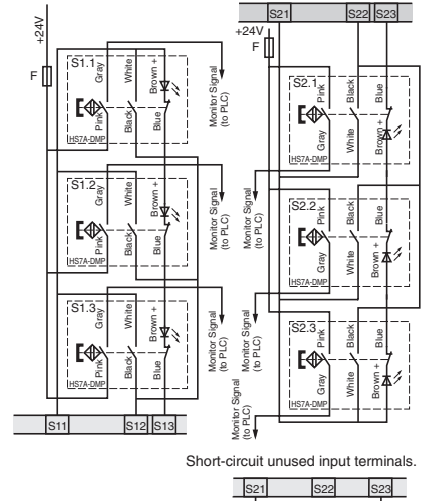

### Safety Category 4 (EN 954-1) Circuit

HR1S-DME + HS7A-DMP50□□ (1NO+2NC) + HS9Z-ZP1

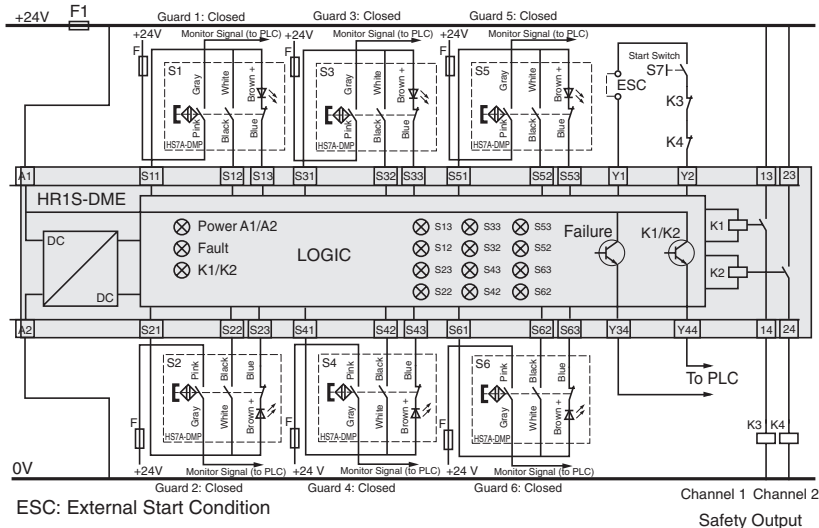

### Safety Category 3 (EN 954-1) Circuit HR1S-DME

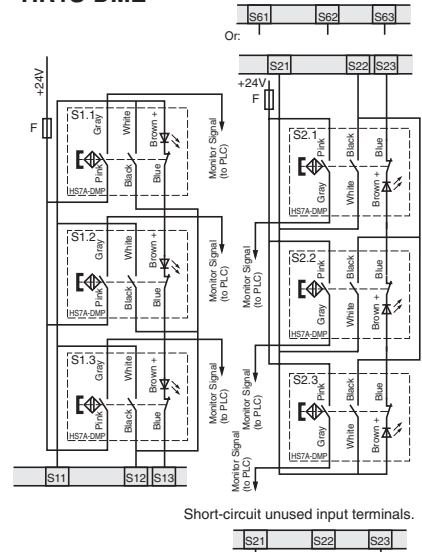

### Safety Category 4 (EN 954-1) Circuit

HR1S-AF + HS7A-DMP70□□ (2NO+1NC) + HS9Z-ZP1

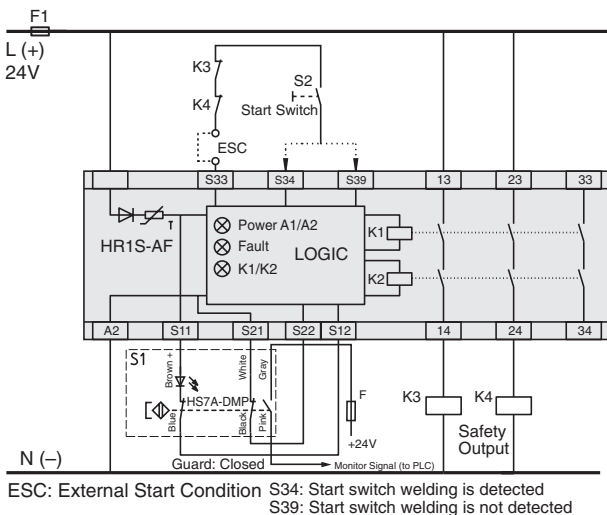

F1: Protection fuse for the power of safety relay module  
F: Protection fuse for monitor signal contacts (max. 500mA gG (gL))

Note: The circuit example shown on the left (HR1S-AF and HS7A-DMP70□□) may not conform to safety category 4 depending on the operating conditions, such as the frequency of safety function check. Perform risk assessment of your system before operation.

## Safety Precautions

- In order to avoid electric shock or fire, turn the power off before installation, removal, wire connection, maintenance, or inspection of the non-contact interlock switch.
- Do not install the actuator in the location where the human body may come in contact. Otherwise injury may occur.

## Instructions

- Safety category 4 (EN954-1) can be achieved by combining the HS7A non-contact interlock switch and HR1S safety relay module (monitor the dual contacts using the safety relay module).
- When using non-contact interlock switches, combine with a proprietary safety relay module and confirm that the conformable safety category and the safety category (EN954-1) required to the machinery have been achieved.
- Be sure to use the HS7A non-contact interlock switch in combination with the proprietary actuator HS9Z-ZP1. Do not use other actuators.
- Regardless of door types, do not use the non-contact interlock switch as a door stop. Install a mechanical door stop on the edge of the door to protect the interlock switch against excessive force.
- A shock to the door exceeding  $300 \text{ m/s}^2$  (approx. 30G) may cause a failure to the non-contact interlock switches.
- Do not store the switches in a dusty, humid, organic-gas atmosphere, or areas subject to direct sunlight.

## Operating Direction

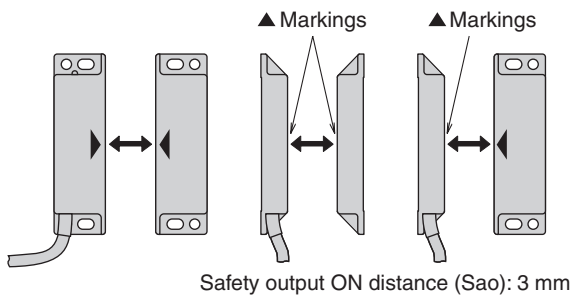

## Precautions for Installation

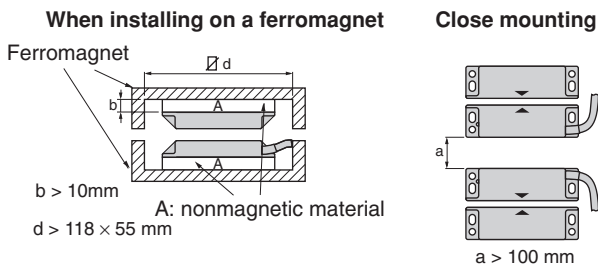

## Tightening Torque

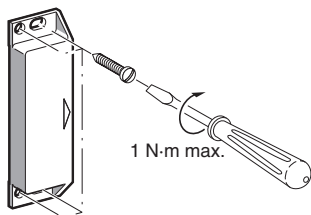

⚠ Use a nonmagnetic screw.

## Precaution for Cable Wiring

- ⚠ Tensile force on the cable may cause disconnection. Be sure to secure the cable near the non-contact interlock switch.

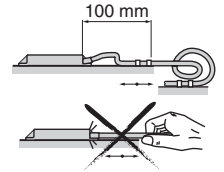

## Precautions for Mounting Actuator

- ⚠ Do not use the non-contact interlock switch as a mechanical stop for the movable guard.
- ⚠ Do not use a hammer to adjust the position of non-contact interlock switch.

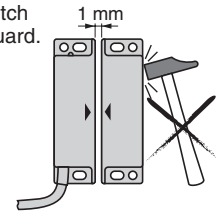

- ⚠ Do not use the non-contact interlock switch in a magnetic field of 0.3 mT or over.

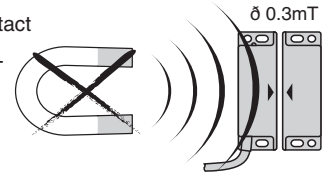

## Operation Chart

HS7A-DMP50 □□  
(1NO+2NC)

HS7A-DMP70 □□  
(2NO+1NC)

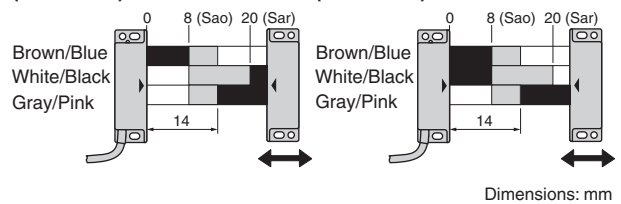

### • Contact Status

■	Contact closed (1)
□	Contact open (0)
▨	Transient area

Sao: Assured operating distance where the safety output is sure to turn on.  
Sar: Assured release distance when the safety output is sure to turn off.

Note: When the transfer time between the actuator's Sao-Sar is 500 ms or longer, the time lag is detected as an error.

### • Operation Area

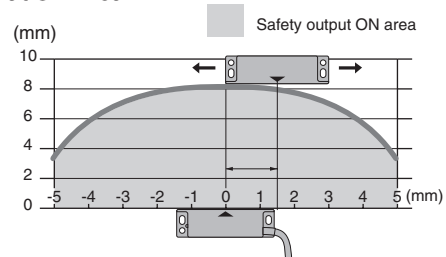

Flush Silhouette

Control Units

Display Lights

Display Units

Safety Products

Terminal Blocks

Comm Terminals

AS-Interface

Relays & Timers

Sockets

Circuit Protectors

Power Supplies

PLCs & SmartRelay

Operator Interfaces

Sensors

Control Stations

Explosion Protection

References