

ZXTN19060CFF

60V, SOT23F, NPN high gain power transistor

Summary

$BV_{CEX} > 160V$

$BV_{CEO} > 60V$

$BV_{ECO} > 6V$

$I_{C(cont)} = 5.5A$

$V_{CE(sat)} < 45mV @ 1A$

$R_{CE(sat)} = 26m\Omega$

$P_D = 1.5W$

Complementary part number ZXTP19060CFF

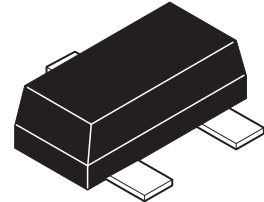

Description

This mid voltage NPN transistor has been designed for applications requiring high gain and low saturation voltage. The SOT23F package is pin compatible with the industry standard SOT23 footprint but offers lower profile and higher dissipation for applications where power density is of utmost importance.

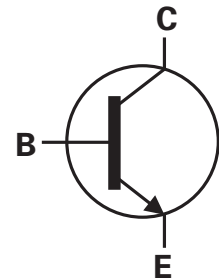

Features

- High gain
- Low saturation voltage
- Low profile small outline package

Applications

- Motor drive
- Siren driver

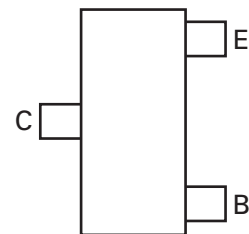

Pinout - top view

Ordering information

Device	Reel size (inches)	Tape width (mm)	Quantity per reel
ZXTN19060CFFTA	7	8	3000

Device marking

1E4

ZXTN19060CFF

Absolute maximum ratings

Parameter	Symbol	Limit	Unit
Collector-base voltage	V_{CBO}	160	V
Collector-emitter voltage (forward blocking)	V_{CEX}	160	V
Collector-emitter voltage	V_{CEO}	60	V
Emitter-collector voltage (reverse blocking)	V_{ECO}	6	V
Emitter-base voltage	V_{EBO}	7	V
Continuous collector current (c)	I_C	5.5	A
Base current	I_B	1	A
Peak pulse current	I_{CM}	12	A
Power dissipation @ $T_{amb} = 25^\circ\text{C}$ (a)	P_D	0.84	W
Linear derating factor		6.72	mW/°C
Power dissipation @ $T_{amb} = 25^\circ\text{C}$ (b)	P_D	1.34	W
Linear derating factor		10.72	mW/°C
Power dissipation @ $T_{amb} = 25^\circ\text{C}$ (c)	P_D	1.50	W
Linear derating factor		12.0	mW/°C
Power dissipation @ $T_{amb} = 25^\circ\text{C}$ (d)	P_D	2.0	W
Linear derating factor		16.0	mW/°C
Operating and storage temperature range	T_j, T_{stg}	- 55 to 150	°C

Thermal resistance

Parameter	Symbol	Limit	Unit
Junction to ambient ^(a)	$R_{\theta JA}$	149.3	°C/W
Junction to ambient ^(b)	$R_{\theta JA}$	93.4	°C/W
Junction to ambient ^(c)	$R_{\theta JA}$	83.3	°C/W
Junction to ambient ^(d)	$R_{\theta JA}$	60	°C/W

NOTES:

- (a) For a device surface mounted on 15mm x 15mm x 1.6mm FR4 PCB with high coverage of single sided 1oz copper, in still air conditions.
- (b) Mounted on 25mm x 25mm x 1.6mm FR4 PCB with a high coverage of single sided 2 oz copper in still air conditions.
- (c) Mounted on 50mm x 50mm x 1.6mm FR4 PCB with a high coverage of single sided 2 oz copper in still air conditions.
- (d) As (c) above measured at $t < 5$ secs.

ZXTN19060CFF

Characteristics

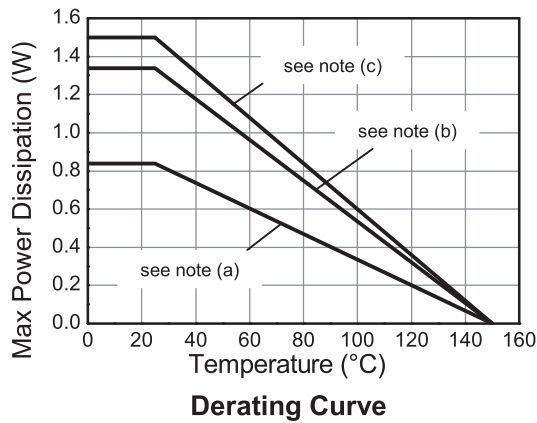
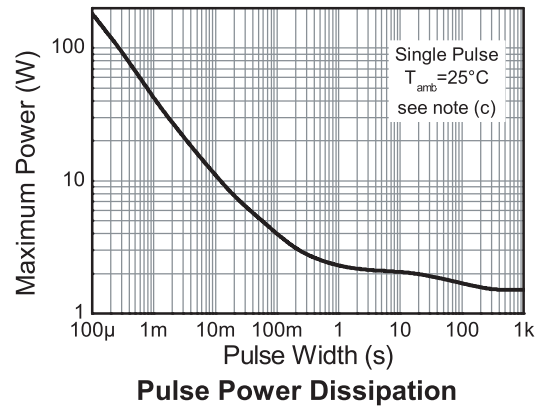
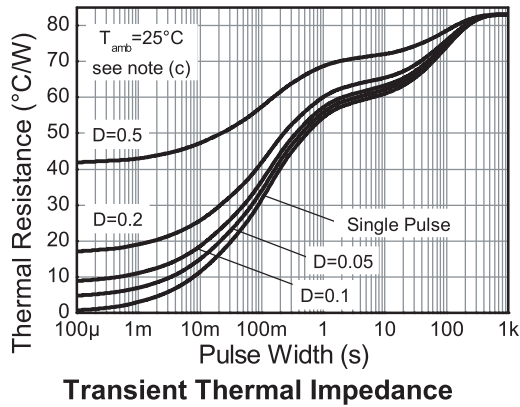
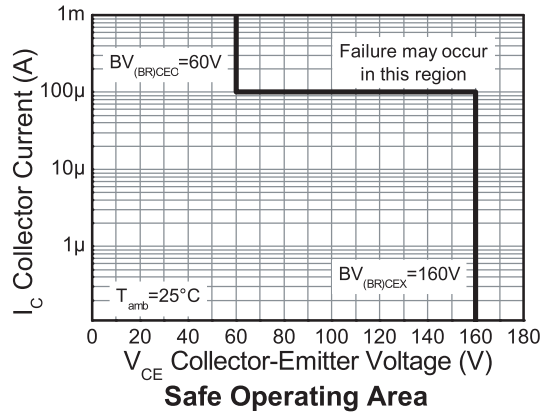
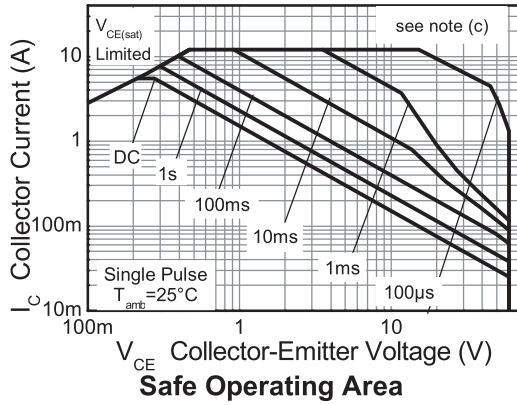

ZXTN19060CFF

Electrical characteristics (at $T_{amb} = 25^{\circ}\text{C}$ unless otherwise stated)

Parameter	Symbol	Min.	Typ.	Max.	Unit	Conditions
Collector-base breakdown voltage	BV_{CBO}	160	200		V	$I_C = 100\mu\text{A}$
Collector-emitter breakdown voltage (forward blocking)	BV_{CEX}	160	200		V	$I_C = 100\mu\text{A}$, $R_{BE} \leq 1\text{k}\Omega$ or $-1\text{V} < V_{BE} < 0.25\text{V}$
Collector-emitter breakdown voltage (base open)	BV_{CEO}	60	75		V	$I_C = 10\text{mA}^{(*)}$
Emitter-base breakdown voltage	BV_{EBO}	7	8.3		V	$I_E = 100\mu\text{A}$
Emitter-collector breakdown voltage (reverse blocking)	BV_{ECX}	6	7		V	$I_E = 100\text{mA}$, $R_{BC} \leq 1\text{k}\Omega$ or $0.25\text{V} > V_{BC} > -0.25\text{V}$
Emitter-collector breakdown voltage (base open)	BV_{ECO}	6	7		V	$I_E = 100\mu\text{A}$,
Collector-base cut-off current	I_{CBO}		<1	50 0.5	nA μA	$V_{CB} = 160\text{V}$ $V_{CB} = 160\text{V}$, $T_{amb} = 100^{\circ}\text{C}$
Collector-emitter cut-off current	I_{CEX}		<1	100	nA	$V_{CE} = 120\text{V}$, $R_{BE} \leq 1\text{k}\Omega$ or $-1\text{V} < V_{BE} < 0.25\text{V}$
Emitter-base cut-off current	I_{EBO}		<1	50	nA	$V_{EB} = 5.6\text{V}$
Collector-emitter saturation voltage	$V_{CE(sat)}$		36 105 105 145	45 150 135 175	mV mV mV mV	$I_C = 1\text{A}$, $I_B = 100\text{mA}^{(*)}$ $I_C = 1\text{A}$, $I_B = 10\text{mA}^{(*)}$ $I_C = 2\text{A}$, $I_B = 40\text{mA}^{(*)}$ $I_C = 5.5\text{A}$, $I_B = 550\text{mA}^{(*)}$
Base-emitter saturation voltage	$V_{BE(sat)}$		1000	1100	mV	$I_C = 5.5\text{A}$, $I_B = 550\text{mA}^{(*)}$
Base-emitter turn-on voltage	$V_{BE(on)}$		880	1000	mV	$I_C = 5.5\text{A}$, $V_{CE} = 2\text{V}^{(*)}$
Static forward current transfer ratio	h_{FE}	200 160 30	350 280 50	500		$I_C = 0.1\text{A}$, $V_{CE} = 2\text{V}^{(*)}$ $I_C = 2\text{A}$, $V_{CE} = 2\text{V}^{(*)}$ $I_C = 6\text{A}$, $V_{CE} = 2\text{V}^{(*)}$
Transition frequency	f_T		130		MHz	$I_C = 50\text{mA}$, $V_{CE} = 10\text{V}$ $f = 50\text{MHz}$
Input capacitance	C_{ibo}		310		pF	$V_{EB} = 0.5\text{V}$, $f = 1\text{MHz}^{(*)}$
Output capacitance	C_{obo}		19.3	25	pF	$V_{CB} = 10\text{V}$, $f = 1\text{MHz}^{(*)}$
Delay time	t_d		27.3		ns	$V_{CC} = 10\text{V}$.
Rise time	t_r		13.2		ns	$I_C = 500\text{mA}$,
Storage time	t_s		682		ns	$I_{B1} = I_{B2} = 50\text{mA}$.
Fall time	t_f		90.9		ns	

NOTES:

(*) Measured under pulsed conditions. Pulse width $\leq 300\mu\text{s}$; duty cycle $\leq 2\%$.

Typical characteristics

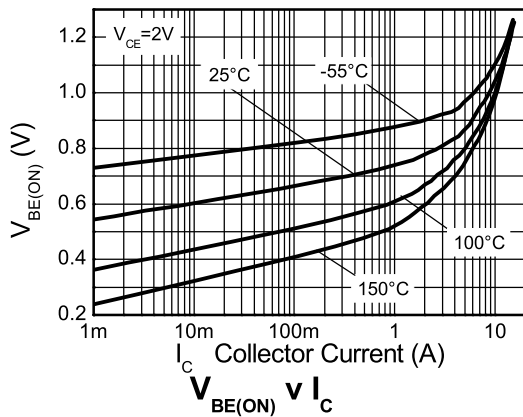
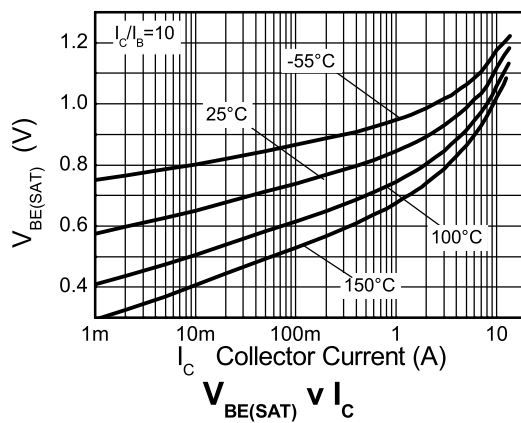
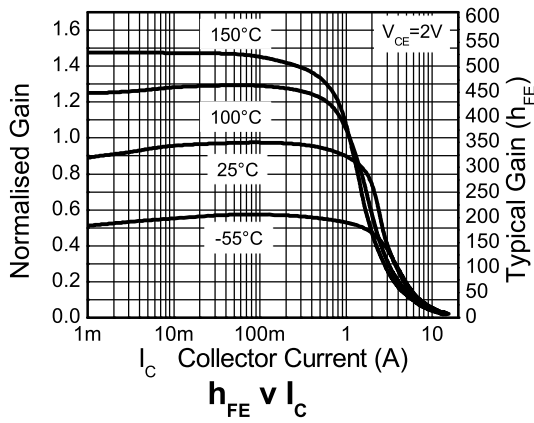
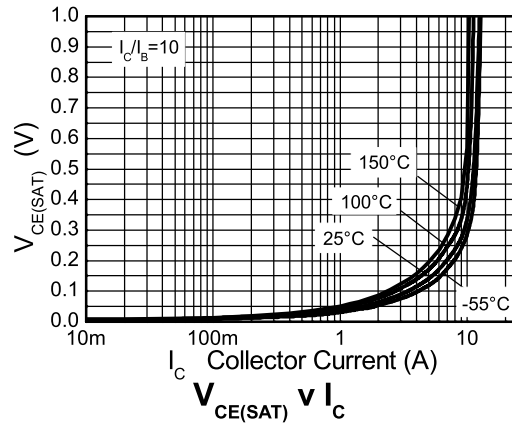
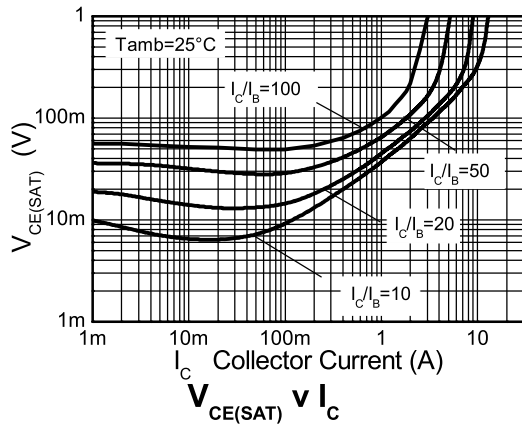

ZXTN19060CFF

Package outline - SOT23F

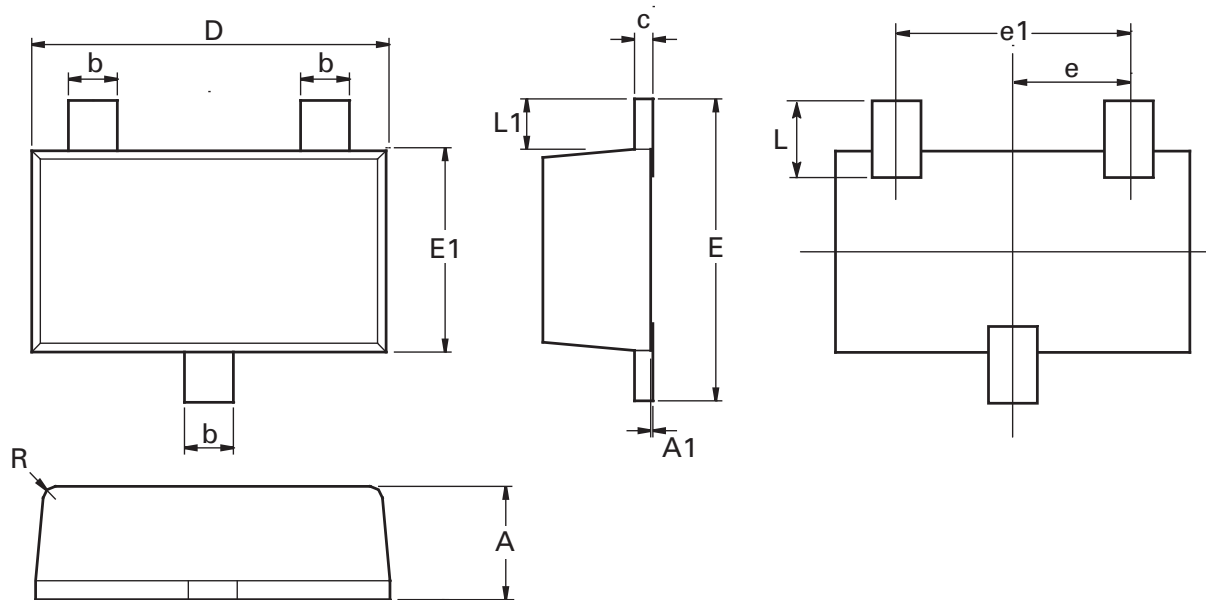

Dim.	Millimeters		Inches		Dim.	Millimeters		Inches	
	Min.	Max.	Min.	Max.		Min.	Max.	Max.	Max.
A	0.80	1.00	0.0315	0.0394	E	2.30	2.50	0.0906	0.0984
A1	0.00	0.10	0.00	0.0043	E1	1.50	1.70	0.0590	0.0669
b	0.35	0.45	0.0153	0.0161	E2	1.10	1.26	0.0433	0.0496
c	0.10	0.20	0.0043	0.0079	L	0.48	0.68	0.0189	0.0268
D	2.80	3.00	0.1102	0.1181	L1	0.30	0.50	0.0153	0.0161
e	0.95 ref		0.0374 ref		R	0.05	0.15	0.0019	0.0059
e1	1.80	2.00	0.0709	0.0787	O	0°	12°	0°	12°

Note: Controlling dimensions are in millimeters. Approximate dimensions are provided in inches

Europe	Americas	Asia Pacific	Corporate Headquarters
Zetex GmbH Kustermann-park Balanstraße 59 D-81541 München Germany Telephone: (49) 89 45 49 49 0 Fax: (49) 89 45 49 49 49 europe.sales@zetex.com	Zetex Inc 700 Veterans Memorial Highway Hauppauge, NY 11788 USA Telephone: (1) 631 360 2222 Fax: (1) 631 360 8222 usa.sales@zetex.com	Zetex (Asia Ltd) 3701-04 Metroplaza Tower 1 Hing Fong Road, Kwai Fong Hong Kong Telephone: (852) 26100 611 Fax: (852) 24250 494 asia.sales@zetex.com	Zetex Semiconductors plc Zetex Technology Park, Chadderton Oldham, OL9 9LL United Kingdom Telephone: (44) 161 622 4444 Fax: (44) 161 622 4446 hq@zetex.com

For international sales offices visit www.zetex.com/offices

Zetex products are distributed worldwide. For details, see www.zetex.com/salesnetwork

This publication is issued to provide outline information only which (unless agreed by the company in writing) may not be used, applied or reproduced for any purpose or form part of any order or contact or be regarded as a representation relating to the products or services concerned. The company reserves the right to alter without notice the specification, design, price or conditions of supply of any product or service.