

NC4 Flat type
(PC board type)

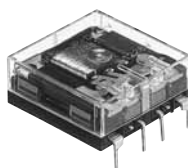

NC2 Flat type
(PC board type)



NC4 Slim type
(Plug-in type)



NC2 Slim type
(PC board type)

FEATURES

1. Compact, slim design

Use of high-performance flat electromagnetic design achieves 10.9 mm .429 inch profile, flat type thin package. Slim type, with width of 11.2 mm .441 inch, enables high-density mounting on PC boards.

2. High reliability

Provides stable contact pressure needed for card lift-off contact driver method. The use of Ac clad twin contacts provides stable contact resistance and ensures high contact reliability.

3. Compatible with all major safety standards

UL and CSA certified, and complies with Japanese Electrical Appliance and Material Control Law.

4. Socket and terminal are available.

TYPICAL APPLICATIONS

1. Information processing and telecom equipment such as computers and terminal devices.
2. Gas hot air heating equipment and air conditioners.
3. Timer, temperature controller and other equipment that requires form factor reduction.
4. Transmission and measuring devices such as facsimile machines and electronic counting devices.
5. Control panels for industrial equipment such as machine tools, factory automation devices, and NC machines.

Compliance with RoHS Directive

ORDERING INFORMATION

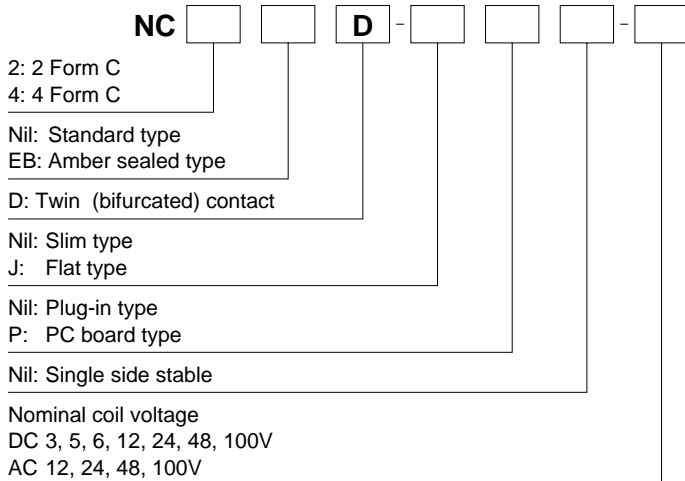

Notes: 1. Certified by UL and CSA
2. Amber sealed types are sealed and filled with inert gas (nitrogen gas).
Sealed construction with terminals, case and base sealed shut with sealing resin.

TYPES

1. Standard type

1) Flat type

| Contact arrangement | Nominal coil voltage | PC board type | |
|---------------------|----------------------|----------------|----------------|
| | | | Part No. |
| 2 Form C | 12V AC | | NC2D-JP-AC12V |
| | 24V AC | | NC2D-JP-AC24V |
| | 48V AC | | NC2D-JP-AC48V |
| | 100V AC | | NC2D-JP-AC100V |
| | 3V DC | | NC2D-JP-DC3V |
| | 5V DC | | NC2D-JP-DC5V |
| | 6V DC | | NC2D-JP-DC6V |
| | 12V DC | | NC2D-JP-DC12V |
| | 24V DC | | NC2D-JP-DC24V |
| | 48V DC | | NC2D-JP-DC48V |
| 100V DC | | NC2D-JP-DC100V | |
| 4 Form C | 12V AC | | NC4D-JP-AC12V |
| | 24V AC | | NC4D-JP-AC24V |
| | 48V AC | | NC4D-JP-AC48V |
| | 100V AC | | NC4D-JP-AC100V |
| | 3V DC | | NC4D-JP-DC3V |
| | 5V DC | | NC4D-JP-DC5V |
| | 6V DC | | NC4D-JP-DC6V |
| | 12V DC | | NC4D-JP-DC12V |
| | 24V DC | | NC4D-JP-DC24V |
| | 48V DC | | NC4D-JP-DC48V |
| 100V DC | | NC4D-JP-DC100V | |

Standard packing: Carton: 20 pcs.; Case: 200 pcs.

2) Slim type

| Contact arrangement | Nominal coil voltage | Plug-in type | | PC board type | |
|---------------------|----------------------|--------------|-------------|---------------|---------------|
| | | | Part No. | | Part No. |
| 2 Form C | 12V AC | | NC2D-AC12V | | NC2D-P-AC12V |
| | 24V AC | | NC2D-AC24V | | NC2D-P-AC24V |
| | 48V AC | | NC2D-AC48V | | NC2D-P-AC48V |
| | 100V AC | | NC2D-AC100V | | NC2D-P-AC100V |
| | 3V DC | | NC2D-DC3V | | NC2D-P-DC3V |
| | 5V DC | | NC2D-DC5V | | NC2D-P-DC5V |
| | 6V DC | | NC2D-DC6V | | NC2D-P-DC6V |
| | 12V DC | | NC2D-DC12V | | NC2D-P-DC12V |
| | 24V DC | | NC2D-DC24V | | NC2D-P-DC24V |
| | 48V DC | | NC2D-DC48V | | NC2D-P-DC48V |
| 100V DC | | NC2D-DC100V | | NC2D-P-DC100V | |
| 4 Form C | 12V AC | | NC4D-AC12V | | NC4D-P-AC12V |
| | 24V AC | | NC4D-AC24V | | NC4D-P-AC24V |
| | 48V AC | | NC4D-AC48V | | NC4D-P-AC48V |
| | 100V AC | | NC4D-AC100V | | NC4D-P-AC100V |
| | 3V DC | | NC4D-DC3V | | NC4D-P-DC3V |
| | 5V DC | | NC4D-DC5V | | NC4D-P-DC5V |
| | 6V DC | | NC4D-DC6V | | NC4D-P-DC6V |
| | 12V DC | | NC4D-DC12V | | NC4D-P-DC12V |
| | 24V DC | | NC4D-DC24V | | NC4D-P-DC24V |
| | 48V DC | | NC4D-DC48V | | NC4D-P-DC48V |
| 100V DC | | NC4D-DC100V | | NC4D-P-DC100V | |

Standard packing: Carton: 20 pcs.; Case: 200 pcs.

NC

2. Amber type

1) Flat type

| Contact arrangement | Nominal coil voltage | PC board type | |
|---------------------|----------------------|------------------|------------------|
| | | Part No. | Part No. |
| 2 Form C | 3V DC | NC2EBD-JP-DC3V | NC2EBD-JP-DC3V |
| | 5V DC | NC2EBD-JP-DC5V | NC2EBD-JP-DC5V |
| | 6V DC | NC2EBD-JP-DC6V | NC2EBD-JP-DC6V |
| | 12V DC | NC2EBD-JP-DC12V | NC2EBD-JP-DC12V |
| | 24V DC | NC2EBD-JP-DC24V | NC2EBD-JP-DC24V |
| | 48V DC | NC2EBD-JP-DC48V | NC2EBD-JP-DC48V |
| | 100V DC | NC2EBD-JP-DC100V | NC2EBD-JP-DC100V |
| 4 Form C | 3V DC | NC4EBD-JP-DC3V | NC4EBD-JP-DC3V |
| | 5V DC | NC4EBD-JP-DC5V | NC4EBD-JP-DC5V |
| | 6V DC | NC4EBD-JP-DC6V | NC4EBD-JP-DC6V |
| | 12V DC | NC4EBD-JP-DC12V | NC4EBD-JP-DC12V |
| | 24V DC | NC4EBD-JP-DC24V | NC4EBD-JP-DC24V |
| | 48V DC | NC4EBD-JP-DC48V | NC4EBD-JP-DC48V |
| | 100V DC | NC4EBD-JP-DC100V | NC4EBD-JP-DC100V |

Standard packing: Carton: 20 pcs.; Case: 200 pcs.

2) Slim type

| Contact arrangement | Nominal coil voltage | Plug-in type | | PC board type | |
|---------------------|----------------------|---------------|---------------|-----------------|-----------------|
| | | Part No. | Part No. | Part No. | Part No. |
| 2 Form C | 3V DC | NC2EBD-DC3V | NC2EBD-DC3V | NC2EBD-P-DC3V | NC2EBD-P-DC3V |
| | 5V DC | NC2EBD-DC5V | NC2EBD-DC5V | NC2EBD-P-DC5V | NC2EBD-P-DC5V |
| | 6V DC | NC2EBD-DC6V | NC2EBD-DC6V | NC2EBD-P-DC6V | NC2EBD-P-DC6V |
| | 12V DC | NC2EBD-DC12V | NC2EBD-DC12V | NC2EBD-P-DC12V | NC2EBD-P-DC12V |
| | 24V DC | NC2EBD-DC24V | NC2EBD-DC24V | NC2EBD-P-DC24V | NC2EBD-P-DC24V |
| | 48V DC | NC2EBD-DC48V | NC2EBD-DC48V | NC2EBD-P-DC48V | NC2EBD-P-DC48V |
| | 100V DC | NC2EBD-DC100V | NC2EBD-DC100V | NC2EBD-P-DC100V | NC2EBD-P-DC100V |
| 4 Form C | 3V DC | NC4EBD-DC3V | NC4EBD-DC3V | NC4EBD-P-DC3V | NC4EBD-P-DC3V |
| | 5V DC | NC4EBD-DC5V | NC4EBD-DC5V | NC4EBD-P-DC5V | NC4EBD-P-DC5V |
| | 6V DC | NC4EBD-DC6V | NC4EBD-DC6V | NC4EBD-P-DC6V | NC4EBD-P-DC6V |
| | 12V DC | NC4EBD-DC12V | NC4EBD-DC12V | NC4EBD-P-DC12V | NC4EBD-P-DC12V |
| | 24V DC | NC4EBD-DC24V | NC4EBD-DC24V | NC4EBD-P-DC24V | NC4EBD-P-DC24V |
| | 48V DC | NC4EBD-DC48V | NC4EBD-DC48V | NC4EBD-P-DC48V | NC4EBD-P-DC48V |
| | 100V DC | NC4EBD-DC100V | NC4EBD-DC100V | NC4EBD-P-DC100V | NC4EBD-P-DC100V |

Standard packing: Carton: 20 pcs.; Case: 200 pcs.

* For sockets, see page 88.

RATING

1. Coil data

1) Single side stable type (AC)

| No. of poles | Nominal coil voltage | Pick-up voltage (at 20°C 68°F) | Drop-out voltage (at 20°C 68°F) | Nominal operating current [$\pm 10\%$] (at 20°C 68°F) | Coil inductance | | Nominal operating power | Max. applied voltage (at 50°C 122°F) |
|--------------|----------------------|---|---|---|-----------------|----------------|-------------------------|--------------------------------------|
| | | | | | N.C. condition | N.O. condition | | |
| 2 Form C | 12V AC | 80%V or less of nominal voltage (Initial) | 10%V or more of nominal voltage (Initial) | 41.5mA | — | — | 0.50VA | 110%V of nominal voltage |
| | 24V AC | | | 22.5mA | — | — | 0.54VA | |
| | 48V AC | | | 14.0mA | — | — | 0.67VA | |
| | 100V AC | | | 10.5mA | — | — | 1.05VA | |
| 4 Form C | 12V AC | 80%V or less of nominal voltage (Initial) | 10%V or more of nominal voltage (Initial) | 92mA | — | — | 1.10VA | 110%V of nominal voltage |
| | 24V AC | | | 45mA | — | — | 1.08VA | |
| | 48V AC | | | 22.5mA | — | — | 1.08VA | |
| | 100V AC | | | 13.0mA | — | — | 1.30VA | |

2) Single side stable (DC)

| No. of poles | Nominal coil voltage | Pick-up voltage (at 20°C 68°F) | Drop-out voltage (at 20°C 68°F) | Nominal operating current [±10%] (at 20°C 68°F) | Coil resistance [±10%] (at 20°C 68°F) | Nominal operating power | Coil inductance | | Max. applied voltage (at 50°C 122°F)* |
|--------------|----------------------|---|---|---|---------------------------------------|-------------------------|-----------------|----------------|---------------------------------------|
| | | | | | | | N.C. condition | N.O. condition | |
| 2 Form C | 3V DC | 80%V or less of nominal voltage (Initial) | 10%V or more of nominal voltage (Initial) | 120mA | 25Ω | 360mW | 24.2mH | 30.0mH | 135%V of nominal voltage |
| | 5V DC | | | 72mA | 69.4Ω | 360mW | 69.5mH | 86.0mH | |
| | 6V DC | | | 60mA | 100Ω | 360mW | 99.4mH | 123mH | |
| | 12V DC | | | 30mA | 400Ω | 360mW | 388mH | 480mH | |
| | 24V DC | | | 15mA | 1,600Ω | 360mW | 1,590mH | 1,970mH | |
| | 48V DC | | | 7.5mA | 6,400Ω | 360mW | 6,270mH | 7,680mH | |
| | 100V DC | | | 7.4mA | 13,500Ω | 740mW | 9,470mH | 11,700mH | |
| 4 Form C | 3V DC | 80%V or less of nominal voltage (Initial) | 10%V or more of nominal voltage (Initial) | 240mA | 12.5Ω | 720mW | 12.8mH | 15.8mH | 110%V of nominal voltage |
| | 5V DC | | | 144mA | 34.7Ω | 720mW | 34.3mH | 42.4mH | |
| | 6V DC | | | 120mA | 50Ω | 720mW | 50.7mH | 62.7mH | |
| | 12V DC | | | 60mA | 200Ω | 720mW | 203mH | 252mH | |
| | 24V DC | | | 30mA | 800Ω | 720mW | 812mH | 1,000mH | |
| | 48V DC | | | 15mA | 3,200Ω | 720mW | 2,820mH | 3,480mH | |
| | 100V DC | | | 7.4mA | 13,500Ω | 740mW | 14,100mH | 17,400mH | |

* At 20°C 68°F (Amber type)

2. Specifications

| Characteristics | Item | Specifications | | | | |
|-----------------------------|--|---|---|---|-----------------------------------|-----------------------------------|
| | | DC | | AC | | |
| | | Single side stable | Single side stable | Single side stable | Single side stable | |
| Contact | Arrangement | 2 Form C | | 4 Form C | | |
| | Contact resistance (Initial) | Max. 50 mΩ (By voltage drop 6 V DC 1A) | | Max. 50 mΩ (By voltage drop 6 V DC 1A) | | |
| | Contact material | Au-clad AgNi type | | Au-clad AgNi type | | |
| Rating | Nominal switching capacity (resistive load) | Standard: 5A 250V AC, 5A 30V DC Amber: 3A 250V AC, 5A 30V DC | | Standard: 4A 250V AC, 5A 30V DC Amber: 2A 250V AC, 5A 30V DC | | |
| | Max. switching power (resistive load) | Standard: 1,250VA, 150W Amber: 750VA, 150W | | Standard: 1,000VA, 150W Amber: 500VA, 150W | | |
| | Max. switching voltage | 250 V AC | | | | |
| | Max. switching current | Standard: 5A Amber: 3A (AC), 5A (DC) | | Standard: 4A Amber: 2A (AC), 5A (DC) | | |
| | Nominal operating power | 360mW (740mW: 100V DC) | 0.50VA to 1.05VA | | 720mW*2 | 1.08VA to 1.30VA |
| | Min. switching capacity (Reference value)*1 | 100μA 1V DC | | 100μA 1VDC | | |
| | Insulation resistance (Initial) | Min. 100MΩ (at 500V DC) Measurement at same location as "Breakdown voltage" section. | | | | |
| Electrical characteristics | Breakdown voltage (Initial) | Between open contacts | 1,000 Vrms for 1min. (Detection current: 10mA.) | | | |
| | | Between contact sets | 1,000 Vrms for 1min. (Detection current: 10mA.) | | | |
| | | Between contact and coil | 2,000 Vrms for 1min. (Detection current: 10mA.) | | | |
| Temperature rise (coil) | Max. 65°C [Max. 85°C (100V AC)] (By resistive method, nominal coil voltage) | | | | | |
| Operate time (at 20°C 68°F) | Max. 20ms | Max. 30ms*3 | | Max. 20ms | Max. 30ms*3 | |
| Release time (at 20°C 68°F) | Max. 10ms | Max. 40ms*3 | | Max. 10ms | Max. 40ms*3 | |
| Mechanical characteristics | Shock resistance | Functional | Min. 98 m/s ² (Half-wave pulse of sine wave: 11 ms; detection time: 10μs.) | | | |
| | | Destructive | Min. 980 m/s ² (Half-wave pulse of sine wave: 6 ms.) | | | |
| | Vibration resistance | Functional | 10 to 55 Hz at double amplitude of 1 mm (Detection time: 10μs.) | | | |
| Destructive | | 10 to 55 Hz at double amplitude of 2 mm | | | | |
| Expected life | Mechanical | Min. 5×10 ⁷ | Min. 10 ⁷ | | Min. 5×10 ⁷ | Min. 10 ⁷ |
| | Electrical (resistive load) | Standard: Min. 10 ⁵ (5A 250V AC), Min. 5×10 ⁵ (5A 30V DC) Amber: Min. 10 ⁵ (3A 250V AC), Min. 5×10 ⁵ (5A 30V DC) | | Standard: Min. 10 ⁵ (4A 250V AC), Min. 5×10 ⁵ (5A 30V DC) Amber: Min. 10 ⁵ (2A 250V AC), Min. 5×10 ⁵ (5A 30V DC) | | |
| Conditions | Conditions for operation, transport and storage*4 (Not freezing and condensing at low temperature) | -40°C to +70°C -40°F to +158°F (Max.48V DC), -40°C to +55°C -40°F to +131°F (100V DC) | -40°C to +60°C -40°F to +140°F*5 | | -40°C to +55°C -40°F to +131°F | -40°C to +40°C -40°F to +104°F |
| | Max. Operating speed | 50 cps | | | | |
| Unit weight | 16 g .56 oz | | | 18 g .63 oz | | |

Notes: *1 This value can change due to the switching frequency, environmental conditions, and desired reliability level, therefore it is recommended to check this with the actual load.

*2. 100V DC: 740mW

*3. For the AC type, the operate and release time differs depending on the phase of the input and cutoff times.

*4. The upper limit of the ambient temperature is the maximum temperature that can satisfy the coil temperature rise value. Refer to Usage, transport and storage conditions in NOTES.

*5. 100V DC: -40°C to +40°C -40°F to +104°F

REFERENCE DATA (Standard type)

1.-(1) Life curve
(AC/DC load 2 Form C, 4 Form C)

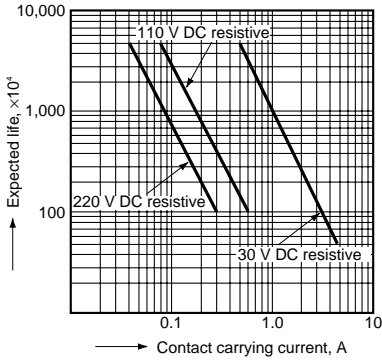

1.-(2) Life curve (AC/DC load 2 Form C)

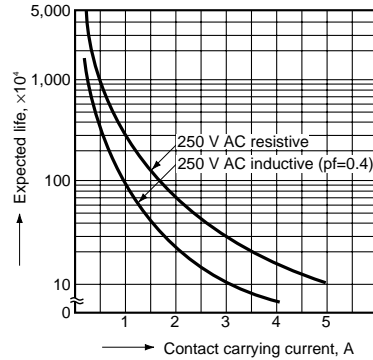

1.-(3) Life curve (AC/DC load 4 Form C)

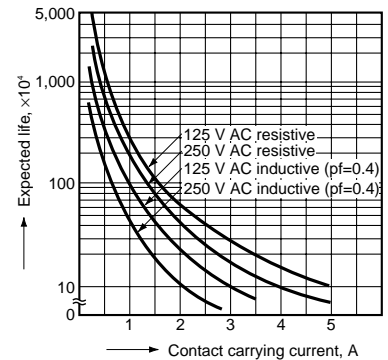

2. Temperature rise characteristics
(single side stable)

Measured portion: Inside the coil

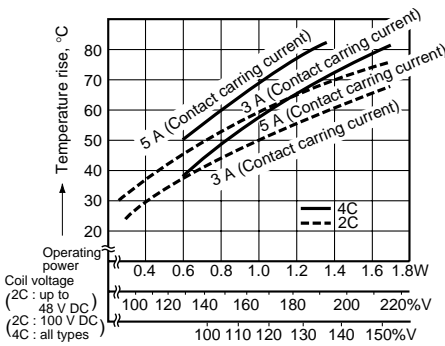

3. Operate time (single side stable)

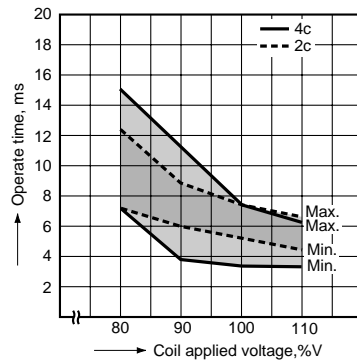

4. Release time (single side stable)

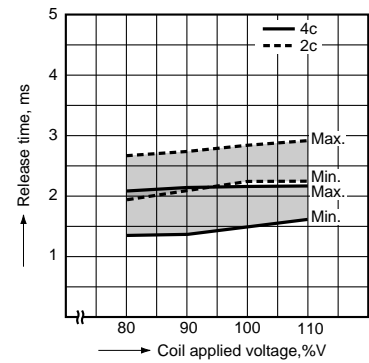

5.-(1) Rate of change of pick-up and drop-out voltage
(2 Form C single side stable)

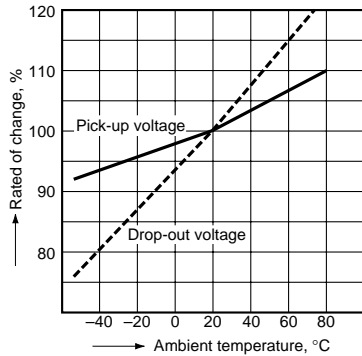

5.-(2) Rate of change of pick-up and drop-out voltage
(4 Form C single side stable)

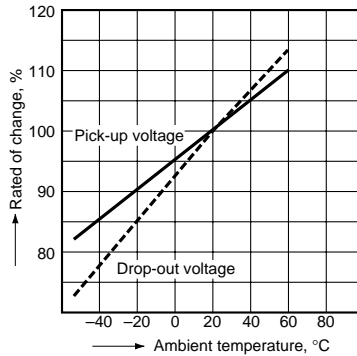

6.-(1) Ambient temperature vs Max. applied voltage

Tested sample:
NC2D-P-DC24 V (2 Form C slim single side stable)

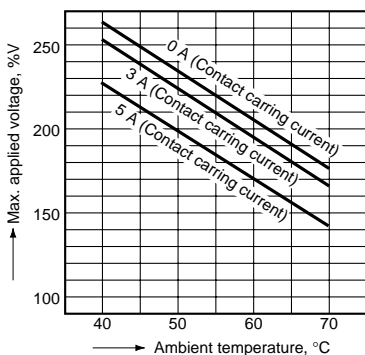

6.-(2) Ambient temperature vs Max. applied voltage

Tested sample:
NC2D-P-DC110 V (2 Form C slim single side stable),
NC4D-P-DC24 V (4 Form C slim single side stable)

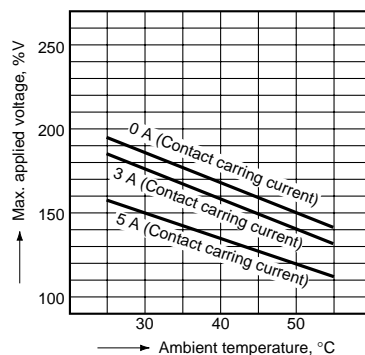

DIMENSIONS (mm inch)

The CAD data of the products with a **CAD Data** mark can be downloaded from: <http://panasonic-electric-works.net/ac>

<Standard type>

Flat type
2 Form C

CAD Data



External dimensions

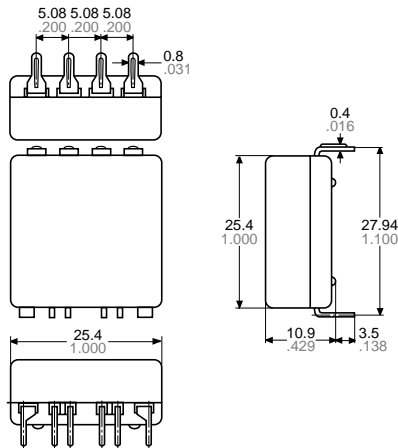

Schematic (Top view)
Single side stable

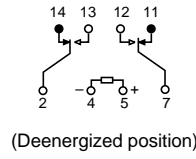

PC board pattern (Bottom view)
Single side stable

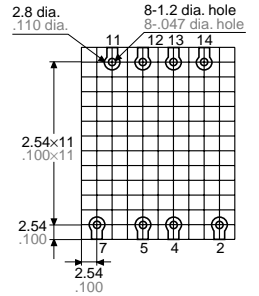

Flat type
4 Form C

CAD Data

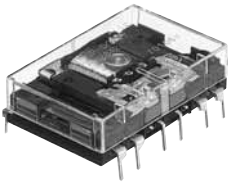

External dimensions

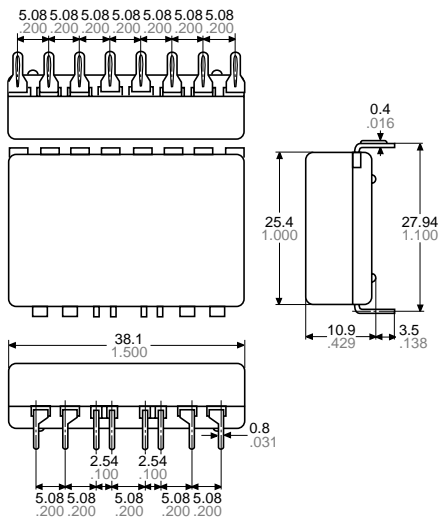

Schematic (Top view)
Single side stable

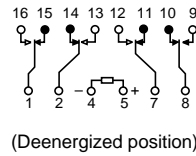

PC board pattern (Bottom view)
Single side stable

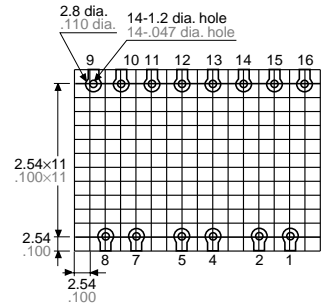

Slim type
Plug-in type
2 Form C

CAD Data

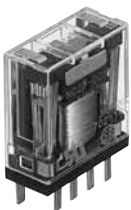

External dimensions

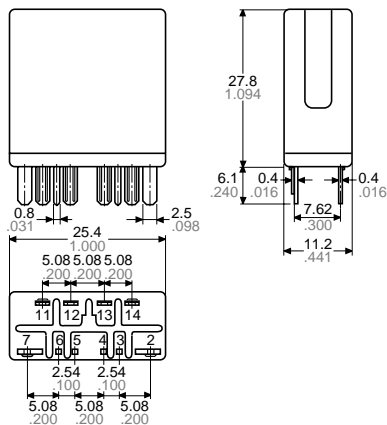

Schematic (Bottom view)
Single side stable

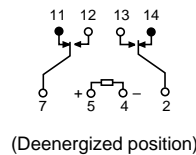

NC

Slim type
Plug-in type
4 Form C

CAD Data



External dimensions

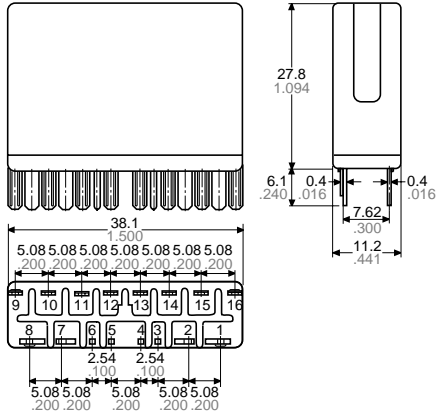

Schematic (Bottom view)
Single side stable

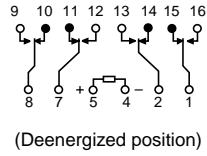

Slim type
PC board type
2 Form C

CAD Data



External dimensions

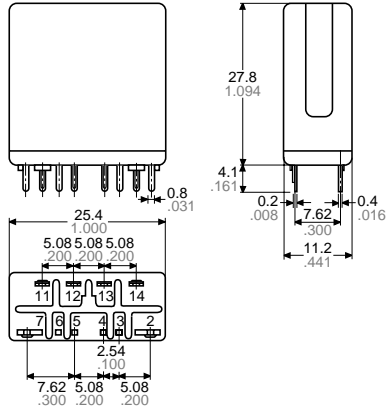

(Dowel heigh: 0.4 .016)

Schematic (Bottom view)
Single side stable

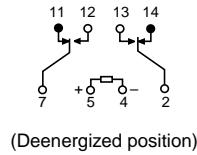

PC board pattern (Bottom view)
Single side stable

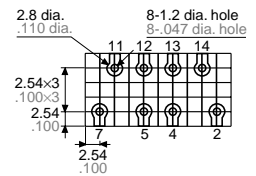

Slim type
PC board type
4 Form C

CAD Data

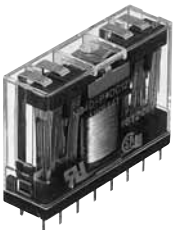

External dimensions

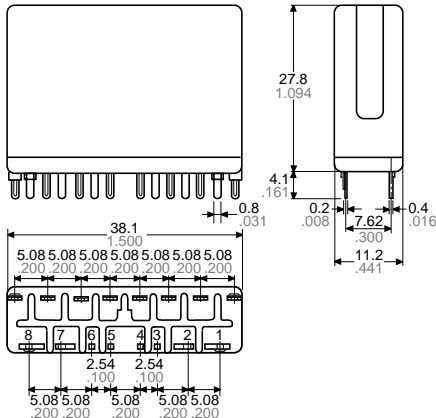

(Dowel heigh: 0.4 .016)

Schematic (Bottom view)
Single side stable

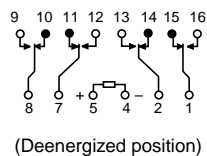

PC board pattern (Bottom view)
Single side stable

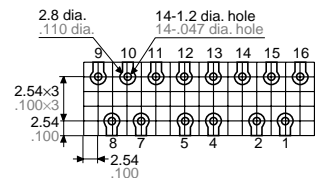

<Amber sealed type>

Flat type
2 Form C

CAD Data



External dimensions

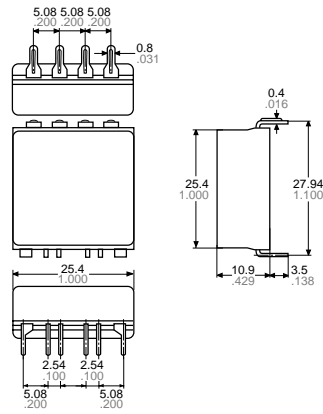

Schematic (Top view)

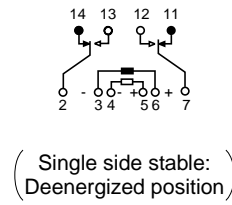

PC board pattern (Bottom view)

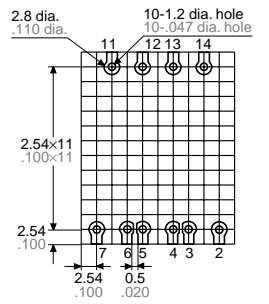

Flat type
4 Form C

CAD Data



External dimensions

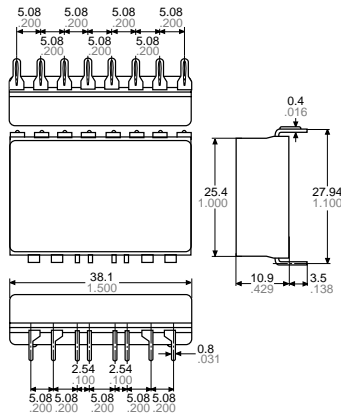

Schematic (Top view)

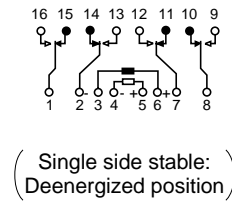

PC board pattern (Bottom view)

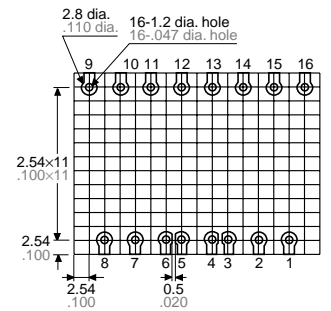

Slim type
Plug-in type
2 Form C

CAD Data



External dimensions

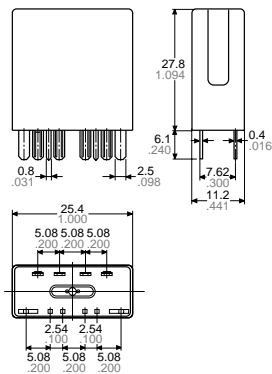

Schematic (Bottom view)

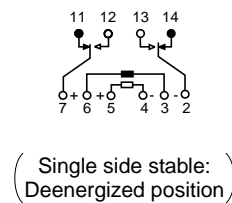

NC

Slim type
Plug-in type
4 Form C

CAD Data



External dimensions

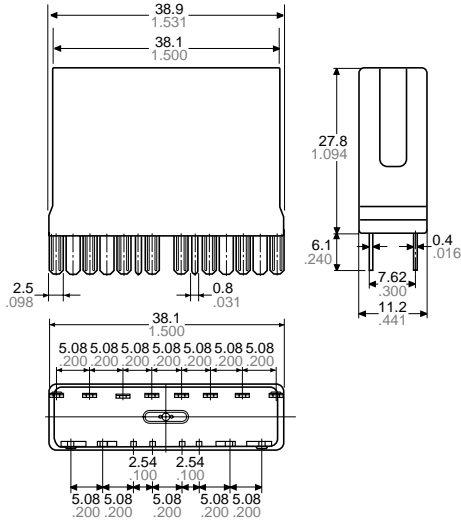

Schematic (Bottom view)

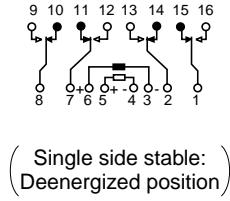

Slim type
PC board type
2 Form C

CAD Data



External dimensions

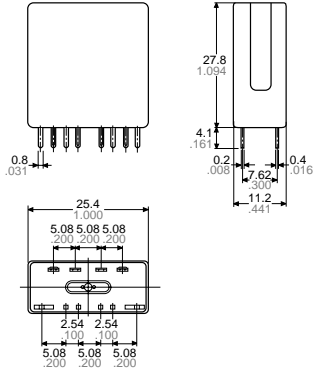

Schematic (Bottom view)

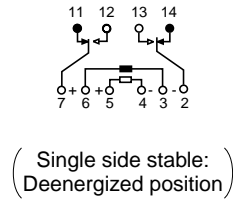

PC board pattern (Bottom view)

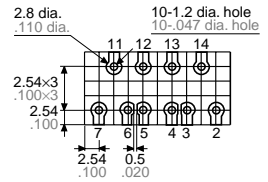

Slim type
PC board type
4 Form C

CAD Data



External dimensions

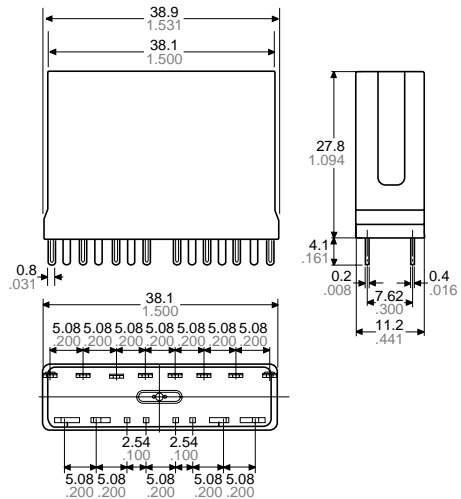

Schematic (Bottom view)

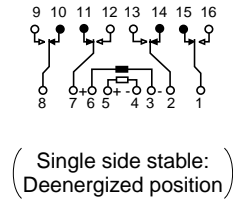

PC board pattern (Bottom view)

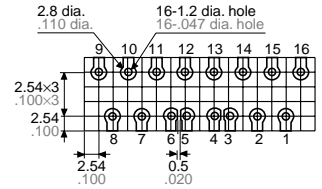

SAFETY STANDARDS

| Product name | | UL/C-UL (Recognized) | | CSA (Certified) | | VDE (Certified) | |
|--------------|----------|----------------------|--|-----------------|--|-----------------|---|
| | | File No. | Contact rating | File No. | Contact rating | File No. | Contact rating |
| NC | 2 Form C | E43028 | 5A 250V AC 1/10HP 125, 250V AC 5A 30V DC | LR26550 etc. | 5A 250V AC 1/10HP 125, 250V AC 5A 30V DC | 1004 | 5A 125V AC (cosφ=1.0) 1A 125V AC (cosφ=0.4) 5A 30V DC (0ms) |
| | 4 Form C | E43028 | 5A 125V AC 4A 250V AC 1/10HP 125, 250V AC 5A 30V DC | LR26550 etc. | 5A 125V AC 4A 250V AC 1/10HP 125, 250V AC 5A 30V DC | 1004 | 5A 125V AC (cosφ=1.0) 1A 125V AC (cosφ=0.4) 5A 30V DC (0ms) |
| NC Amber | 2 Form C | E43028 | 3A 250V AC 1/20HP 125, 250V AC 5A 30V DC | LR26550 etc. | 3A 250V AC 1/20HP 125, 250V AC 5A 30V DC | 1005 | 1A 125V AC (cosφ=1.0) 0.5A 125V AC (cosφ=0.4) 1A 30V DC (0ms) |
| | 4 Form C | E43028 | 2A 250V AC 1/20HP 125, 250V AC 5A 30V DC | LR26550 etc. | 2A 250V AC 1/20HP 125, 250V AC 5A 30V DC | 1005 | 1A 125V AC (cosφ=1.0) 0.5A 125V AC (cosφ=0.4) 1A 30V DC (0ms) |

NOTES

1. Because the NC relay is polarized, the positive “+” and negative “-” connections to the coil should be done as indicated on the wiring diagram. If connected incorrectly, it may malfunction or fail to operate.
2. While NC relays can be used with any transmission-wave current to their operation, due to slight weakening of the force of magnetic attraction, decreased resistance to vibration and shock should be taken into account.
3. The current that energizes the coil in an NC relay is AC type. Because the AC sine waveform is distorted, when testing, it is essential to use a measuring device that can properly characterize the distorted waveform.
The operating power of the coil in the 100 V AC 4 Form C type is relatively higher than other NC types of AC relay and consequently, the total current applied through all the contacts should be kept below 10 A.
4. The AC type NC relay has a special magnetic design. As a result, once the a-side contacts have switched, the b-side contacts may once again go into a temporary ON state depending on the coil inrush phase. To ensure that this phenomenon does not occur, it is necessary to carry out sufficient practical testing with relays installed in actual devices.

5. When designing top and bottom view schematic diagrams, note that:
 - 1) “Top view” wiring diagram is indicated for the flat series because terminals can be seen from above.
 - 2) “Bottom view” schematic diagram is indicated for the vertical series because terminals cannot be seen from above.

6. Cautions for close proximity mounting
When using slim series in close proximity, mount all relays facing the same direction. Different mounting directions may cause change in the relay characteristics because NC relays are polarized.

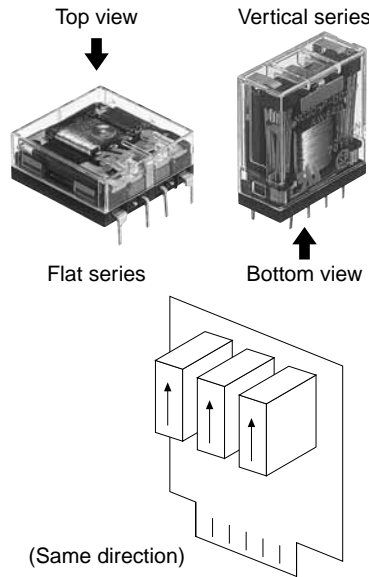

For Cautions for Use.

ACCESSORIES **NC RELAYS**
(sockets and terminal sockets)

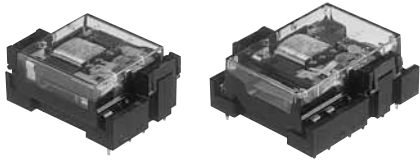

NC2 Flat type socket



NC4 Flat type socket



NC2 Slim type socket



NC4 Slim type socket



NC2 DIN terminal socket

FEATURES

• **Socket**

1) The vertical (slim) type with solder terminals has a retainer, which enables snap-in fixing on chassis, panels, and similar locations. Because the sockets for both solder terminals and PC boards firmly fix the relay at the time of insertion, once snapped in, spring clips are unnecessary.

2) For the flat type, pull up the hinged clasps in the direction of the arrows shown in the drawing after inserting the relay. Spring clips are unnecessary.

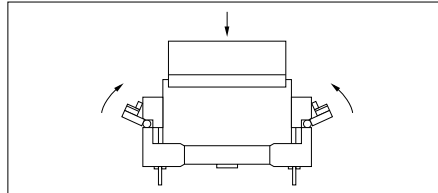

Compliance with RoHS Directive

TYPES

| | Product name | Terminals | Part No. |
|---------------------------|-------------------------------|-----------|----------|
| Flat type socket | NC2-flat type PC board socket | P/C board | NC2-JPS |
| | NC4-flat type PC board socket | P/C board | NC4-JPS |
| Slim type terminal socket | NC2-DIN terminal socket | DIN rail | NC2-SFD |
| Slim type socket | NC2-slim type socket | Solder | NC2-SS |
| | NC2-slim type PC board socket | P/C board | NC2-PS |
| | NC2-slim type wrapping socket | Lead wire | NC2-WS |
| | NC4-slim type socket | Solder | NC4-SS |
| | NC4-slim type PC board socket | P/C board | NC4-PS |
| | NC4-slim type wrapping socket | Lead wire | NC4-WS |

SPECIFICATIONS (common)

| Item | Specifications |
|-------------------------------|---|
| Max. continuous current | Slim type: 5A 250V AC, Flat type: 5A 250V AC |
| Initial breakdown voltage | 2,000 V AC (Except for coil to coil of L2 type: 1,500 V AC) |
| Initial insulation resistance | Min. 100MΩ (at 500V DC megger) |
| Heat resistance | 150°C 302°F for 1 hour |

Note: Do not insert or remove relays while in the energized condition.

DIMENSIONS (mm inch)

The CAD data of the products with a **CAD Data** mark can be downloaded from: <http://panasonic-electric-works.net/ac>

Flat type socket for PC board
NC2-JPS

CAD Data

External dimensions

Terminal portion

PC board pattern

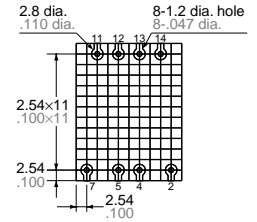
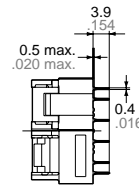
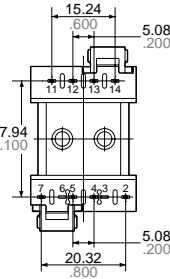
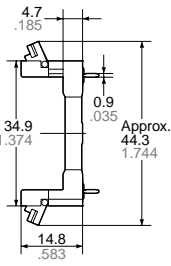
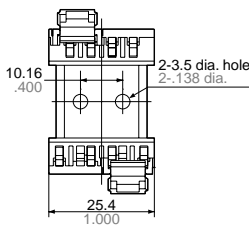

Flat type socket for PC board
NC4-JPS

CAD Data

External dimensions

Terminal portion

PC board pattern

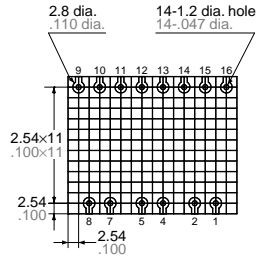
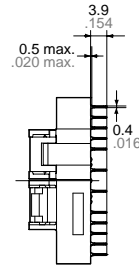
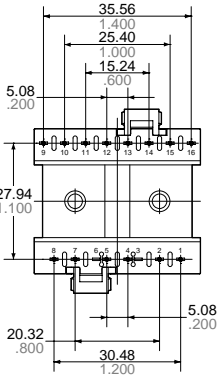
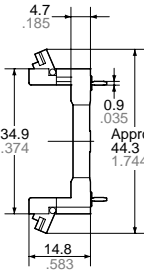
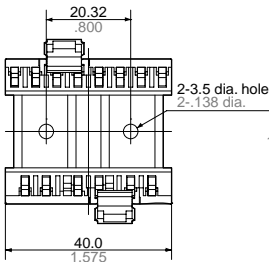

Slim type DIN terminal socket
NC2-SFD

CAD Data

External dimensions

Mounting hole diagram

Schematic

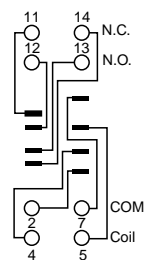
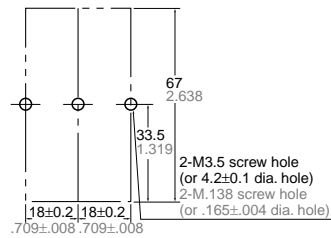
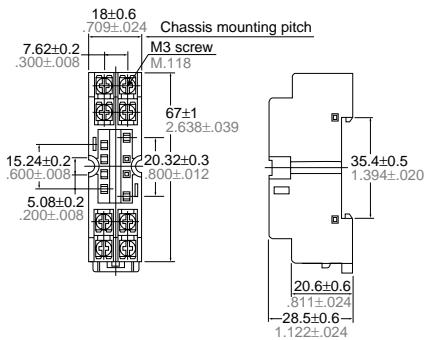
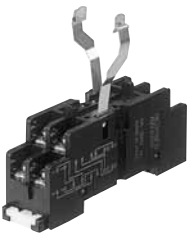

(Retaining springs are included with the DIN terminal socket.)

*To prevent damage or distortion, when tightening fixing screws, the optimum torque range should be 0.49 to 0.69 N·m, (5 to 7 kgf·cm).

NC

Slim type socket for solder terminal NC2-SS

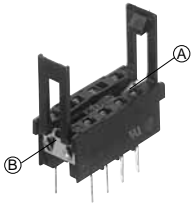

CAD Data

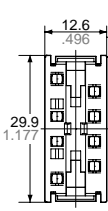

External dimensions

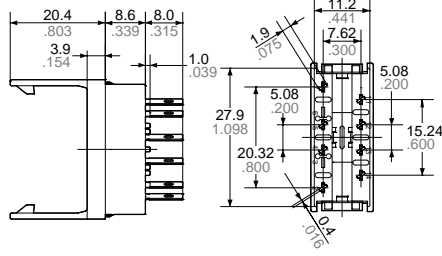

Chassis cutout

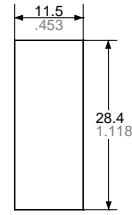

- Notes: 1. Suitable chassis thickness is 1.0 to 2.0 mm .039 to .079 inch.
2. Once the socket is inserted from above into the mounting holes, the relay will snap in to clips rising from either side at (A) and (B) by pushing.

Slim type socket for solder terminal NC4-SS

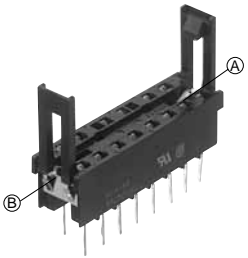

CAD Data

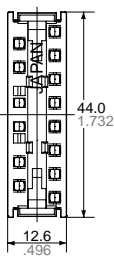

External dimensions

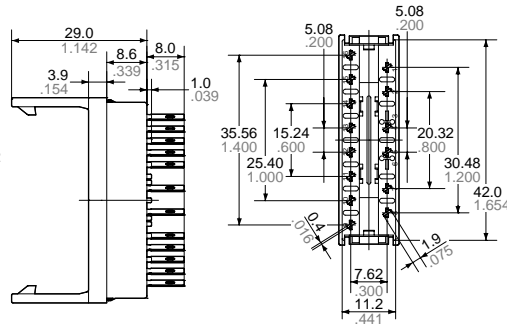

Chassis cutout

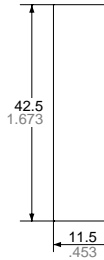

- Notes: 1. Suitable chassis thickness is 1.0 to 2.0 mm .039 to .079 inch.
2. Once the socket is inserted from above into the mounting holes, the relay will snap in to clips rising from either side at (A) and (B) by pushing.

Slim type socket for PC board NC2-PS



CAD Data

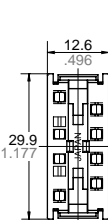

External dimensions

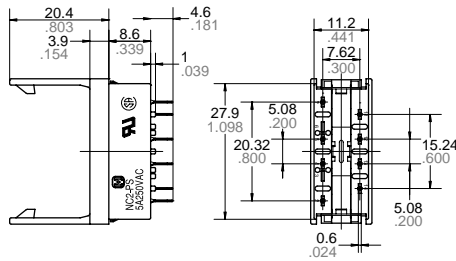

PC board pattern

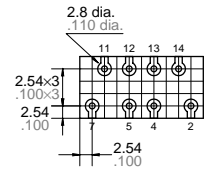

Slim type socket for PC board NC4-PS



CAD Data

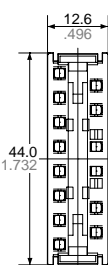

External dimensions

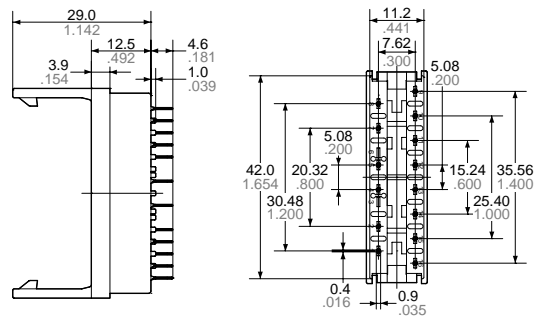

PC board pattern

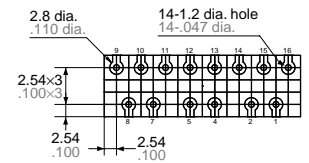

**Vertical (Slim) type
wrapping socket
NC2-WS**



CAD Data

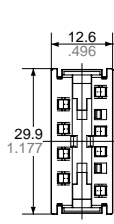

External dimensions

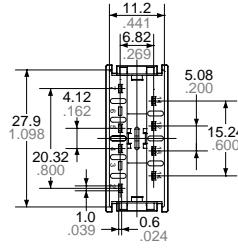
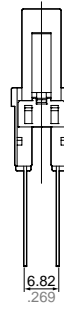
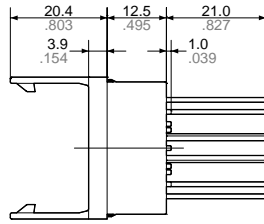

Terminal cross section

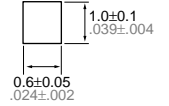

Chassis cutout

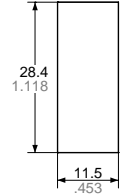

**Vertical (Slim) type
wrapping socket
NC4-WS**



CAD Data



External dimensions

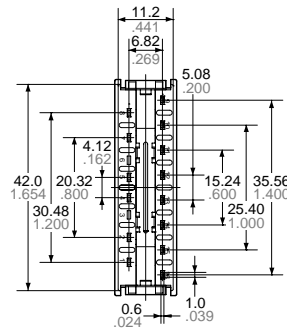
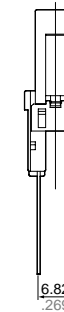
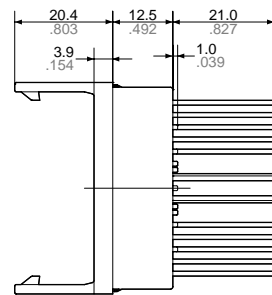

Chassis cutout

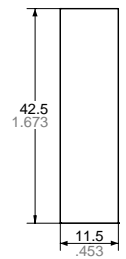

NOTES

1. Soldering should be done quickly to avoid damaging the thermoplastic body.
2. For solder terminal types, connect terminals as shown in the diagram at right to maintain insulation distance.

