

Small Signal Schottky Diode

Features

- Integrated protection ring against static discharge
- Very low forward voltage
- AEC-Q101 qualified
- Compliant to RoHS directive 2002/95/EC and in accordance to WEEE 2002/96/EC

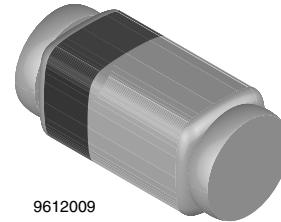
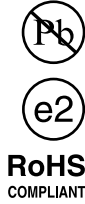

9612009

Applications

- Applications where a very low forward voltage is required

Mechanical Data

Case: QuadromELF SOD-80

Weight: approx. 34 mg

Cathode band color: black

Packaging codes/options:

GS18 / 10 k per 13" reel (8 mm tape), 10 k/box

GS08 / 2.5 k per 7" reel (8 mm tape), 12.5 k/box

Parts Table

Part	Type differentiation	Ordering code	Remarks
BAS285	$V_R = 30\text{ V}$	BAS285-GS18 or BAS285-GS08	Tape and Reel

Absolute Maximum Ratings

$T_{amb} = 25\text{ }^\circ\text{C}$, unless otherwise specified

Parameter	Test condition	Symbol	Value	Unit
Reverse voltage		V_R	30	V
Peak forward surge current	$t_p = 10\text{ ms}$	I_{FSM}	5	A
Repetitive peak forward current	$t_p \leq 1\text{ s}$	I_{FRM}	300	mA
Forward current		I_F	200	mA
Average forward current		I_{FAV}	200	mA

Thermal Characteristics

$T_{amb} = 25\text{ }^\circ\text{C}$, unless otherwise specified

Parameter	Test condition	Symbol	Value	Unit
Junction to ambient air	on PC board 50 mm x 50 mm x 1.6 mm	R_{thJA}	320	K/W
Junction temperature		T_j	125	$^\circ\text{C}$
Storage temperature range		T_{stg}	- 65 to + 150	$^\circ\text{C}$

Electrical Characteristics

$T_{amb} = 25\text{ }^{\circ}\text{C}$, unless otherwise specified

Parameter	Test condition	Symbol	Min	Typ.	Max	Unit
Forward voltage	$I_F = 0.1\text{ mA}$	V_F			240	mV
	$I_F = 1\text{ mA}$	V_F			320	mV
	$I_F = 10\text{ mA}$	V_F			400	mV
	$I_F = 30\text{ mA}$	V_F			500	mV
	$I_F = 100\text{ mA}$	V_F			800	mV
Reverse current	$V_R = 25\text{ V}$, $t_p = 300\text{ }\mu\text{s}$	I_R			2.3	μA
Diode capacitance	$V_R = 1\text{ V}$, $f = 1\text{ MHz}$	C_D			10	pF

Typical Characteristics

$T_{amb} = 25\text{ }^{\circ}\text{C}$, unless otherwise specified

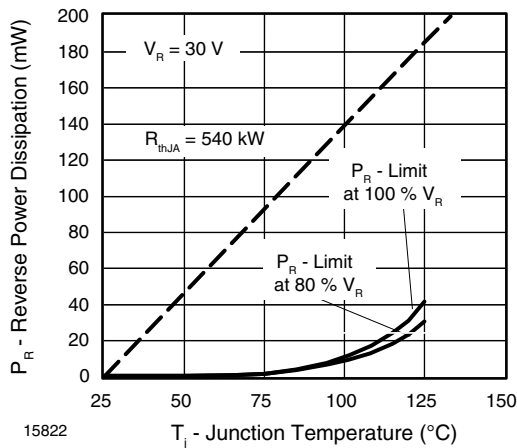

Figure 1. Max. Reverse Power Dissipation vs. Junction Temperature

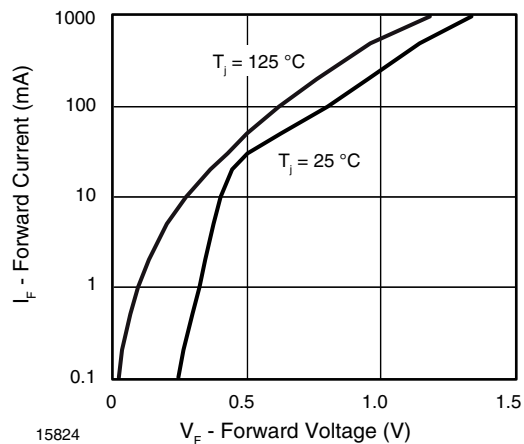

Figure 3. Forward Current vs. Forward Voltage

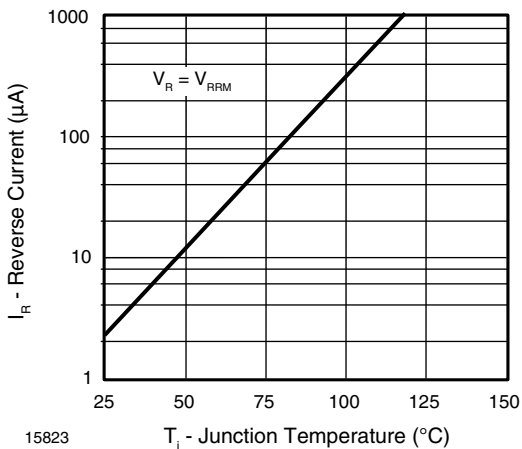

Figure 2. Reverse Current vs. Junction Temperature

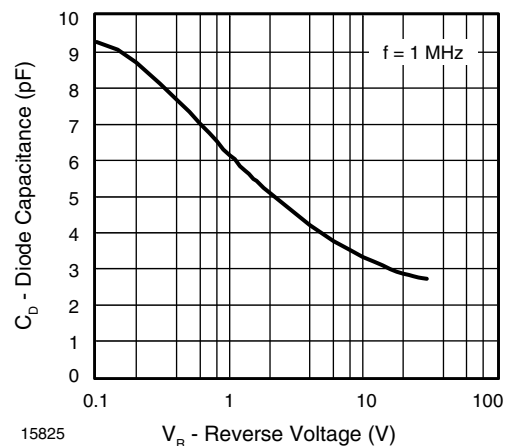
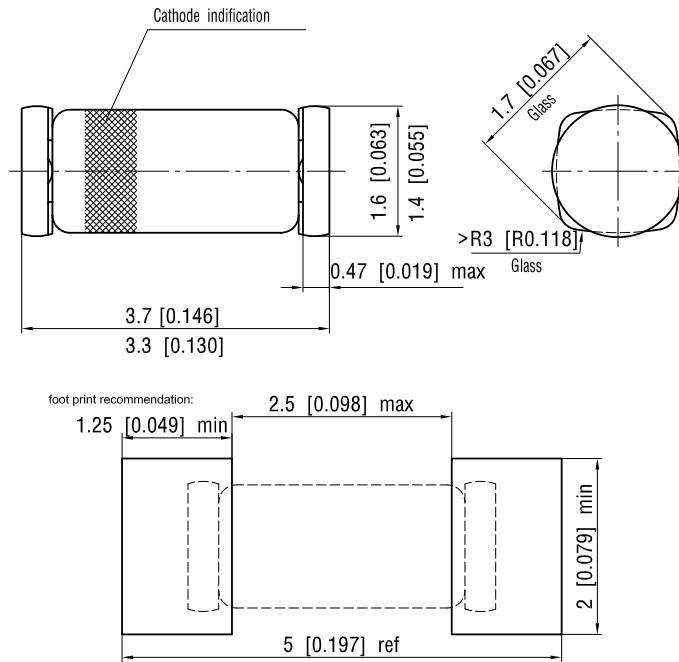

Figure 4. Diode Capacitance vs. Reverse Voltage

Package Dimensions in millimeters (inches): QuadroMELF SOD-80



Document no.: 6.560-5006.01-4
Rev. 10 - Date: 30.August.2004

12071



Disclaimer

ALL PRODUCT, PRODUCT SPECIFICATIONS AND DATA ARE SUBJECT TO CHANGE WITHOUT NOTICE TO IMPROVE RELIABILITY, FUNCTION OR DESIGN OR OTHERWISE.

Vishay Intertechnology, Inc., its affiliates, agents, and employees, and all persons acting on its or their behalf (collectively, "Vishay"), disclaim any and all liability for any errors, inaccuracies or incompleteness contained in any datasheet or in any other disclosure relating to any product.

Vishay makes no warranty, representation or guarantee regarding the suitability of the products for any particular purpose or the continuing production of any product. To the maximum extent permitted by applicable law, Vishay disclaims (i) any and all liability arising out of the application or use of any product, (ii) any and all liability, including without limitation special, consequential or incidental damages, and (iii) any and all implied warranties, including warranties of fitness for particular purpose, non-infringement and merchantability.

Statements regarding the suitability of products for certain types of applications are based on Vishay's knowledge of typical requirements that are often placed on Vishay products in generic applications. Such statements are not binding statements about the suitability of products for a particular application. It is the customer's responsibility to validate that a particular product with the properties described in the product specification is suitable for use in a particular application. Parameters provided in datasheets and/or specifications may vary in different applications and performance may vary over time. All operating parameters, including typical parameters, must be validated for each customer application by the customer's technical experts. Product specifications do not expand or otherwise modify Vishay's terms and conditions of purchase, including but not limited to the warranty expressed therein.

Except as expressly indicated in writing, Vishay products are not designed for use in medical, life-saving, or life-sustaining applications or for any other application in which the failure of the Vishay product could result in personal injury or death. Customers using or selling Vishay products not expressly indicated for use in such applications do so at their own risk and agree to fully indemnify and hold Vishay and its distributors harmless from and against any and all claims, liabilities, expenses and damages arising or resulting in connection with such use or sale, including attorneys fees, even if such claim alleges that Vishay or its distributor was negligent regarding the design or manufacture of the part. Please contact authorized Vishay personnel to obtain written terms and conditions regarding products designed for such applications.

No license, express or implied, by estoppel or otherwise, to any intellectual property rights is granted by this document or by any conduct of Vishay. Product names and markings noted herein may be trademarks of their respective owners.