

## Small Signal Zener Diodes, Dual

### Features

- These diodes are also available in other case styles and configurations including: the dual diode common cathode configuration with type designation DZ23, the single diode SOT-23 case with the type designation BZX84C, and the single diode SOD-123 case with the type designation BZT52C.
- Dual silicon planar Zener diodes, common anode
- The Zener voltages are graded according to the international E 24 standard
- The parameters are valid for both diodes in one case.  $\Delta V_Z$  and  $\Delta r_{z1}$  of the two diodes in one case is  $\leq 5\%$
- AEC-Q101 qualified
- Compliant to RoHS directive 2002/95/EC and in accordance to WEEE 2002/96/EC



RoHS  
COMPLIANT

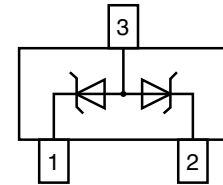
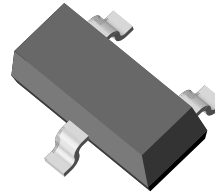

18070

### Mechanical Data

**Case:** SOT-23

**Weight:** approx. 8.8 mg

**Packaging codes/options:**

GS18/10 k per 13" reel, (8 mm tape), 10 k/box

GS08/3 k per 7" reel, (8 mm tape), 15 k/box

### Absolute Maximum Ratings

$T_{amb} = 25\text{ }^\circ\text{C}$ , unless otherwise specified

Parameter	Test conditions	Symbol	Value	Unit
Power dissipation		$P_{tot}$	300 <sup>1)</sup>	mW

#### Note

<sup>1)</sup> Device on fiberglass substrate, see layout on page 6

### Thermal Characteristics

$T_{amb} = 25\text{ }^\circ\text{C}$ , unless otherwise specified

Parameter	Test conditions	Symbol	Value	Unit
Thermal resistance junction to ambient air		$R_{thJA}$	420 <sup>1)</sup>	K/W
Junction temperature		$T_j$	150	$^\circ\text{C}$
Storage temperature range		$T_{stg}$	- 65 to + 150	$^\circ\text{C}$

#### Note

<sup>1)</sup> Device on fiberglass substrate, see layout on page 6

## Electrical Characteristics

Part number	Marking code	Zener voltage range <sup>1)</sup>		Dynamic resistance		Test current	Temperature coefficient of zener voltage		Reverse voltage
		$V_Z$ at $I_{ZT}$		$r_{zj}$ at $I_{ZT} = 5 \text{ mA}$ , $f = 1 \text{ kHz}$	$r_{zj}$ at $I_{ZT} = 1 \text{ mA}$ , $f = 1 \text{ kHz}$	$I_{ZT}$	$\alpha_{VZ}$ at $I_{ZT}$		$V_R$ at $I_R = 100 \text{ nA}$
		V		$\Omega$		mA	$10^{-4}/^{\circ}\text{C}$		V
		min.	max.				min.	max.	
AZ23C2V7-V	D1	2.5	2.9	75 (< 83)	< 500	5	-9	-4	-
AZ23C3V0-V	D2	2.8	3.2	80 (< 95)	< 500	5	-9	-3	-
AZ23C3V3-V	D3	3.1	3.5	80 (< 95)	< 500	5	-8	-3	-
AZ23C3V6-V	D4	3.4	3.8	80 (< 95)	< 500	5	-8	-3	-
AZ23C3V9-v	D5	3.7	4.1	80 (< 95)	< 500	5	-7	-3	-
AZ23C4V3-V	D6	4	4.6	80 (< 95)	< 500	5	-6	-1	-
AZ23C4V7-V	D7	4.4	5	70 (< 78)	< 500	5	-5	2	-
AZ23C5V1-V	D8	4.8	5.4	30 (< 60)	< 480	5	-3	4	> 0.8
AZ23C5V6-V	D9	5.2	6	10 (< 40)	< 400	5	-2	6	> 1
AZ23C6V2-V	D10	5.8	6.6	4.8 (< 10)	< 200	5	-1	7	> 2
AZ23C6V8-V	D11	6.4	7.2	4.5 (< 8)	< 150	5	2	7	> 3
AZ23C7V5-V	D12	7	7.9	4 (< 7)	< 50	5	-3	7	> 5
AZ23C8V2-V	D13	7.7	8.7	4.5 (< 7)	< 50	5	4	7	> 6
AZ23C9V1-V	D14	8.5	9.6	4.8 (< 10)	< 50	5	5	8	> 7
AZ23C10-V	D15	9.4	10.6	5.2 (< 15)	< 70	5	5	8	> 7.5
AZ23C11-V	D16	10.4	11.6	6 (< 20)	< 70	5	5	9	> 8.5
AZ23C12-V	D17	11.4	12.7	7 (< 20)	< 90	5	6	9	> 9
AZ23C13-V	D18	12.4	14.1	9 (< 25)	< 110	5	7	9	> 10
AZ23C15-V	D19	13.8	15.6	11 (< 30)	< 110	5	7	9	> 11
AZ23C16-V	D20	15.3	17.1	13 (< 40)	< 170	5	8	9.5	> 12
AZ23C18-V	D21	16.8	19.1	18 (< 50)	< 170	5	8	9.5	> 14
AZ23C20-V	D22	18.8	21.2	20 (< 50)	< 220	5	8	10	> 15
AZ23C22-V	D23	20.8	23.3	25 (< 55)	< 220	5	8	10	> 17
AZ23C24-V	D24	22.8	25.6	28 (< 80)	< 220	5	8	10	> 18
AZ23C27-V	D25	25.1	28.9	30 (< 80)	< 250	5	8	10	> 20
AZ23C30-V	D26	28	32	35 (< 80)	< 250	5	8	10	> 22.5
AZ23C33-V	D27	31	35	40 (< 80)	< 250	5	8	10	> 25
AZ23C36-V	D28	34	38	40 (< 90)	< 250	5	8	10	> 27
AZ23C39-V	D29	37	41	50 (< 90)	< 300	5	10	12	> 29
AZ23C43-V	D30	40	46	60 (< 100)	< 700	5	10	12	> 32
AZ23C47-V	D31	44	50	70 (< 100)	< 750	5	10	12	> 35
AZ23C51-V	D32	48	54	70 (< 100)	< 750	5	10	12	> 38

**Note**

<sup>1)</sup> Tested with pulses  $t_p = 5 \text{ ms}$

## Electrical Characteristics

Part number	Marking code	Zener voltage range <sup>1)</sup>		Dynamic resistance		Test current	Temperature coefficient of Zener voltage		Reverse voltage
		$V_Z$ at $I_{ZT}$		$r_{zj}$ at $I_{ZT} = 5 \text{ mA}$ , $f = 1 \text{ kHz}$	$r_{zj}$ at $I_{ZT} = 1 \text{ mA}$ , $f = 1 \text{ kHz}$	$I_{ZT}$	$\alpha_{VZ}$ at $I_{ZT}$		$V_R$ at $I_R = 100 \text{ nA}$
		V		$\Omega$		mA	$10^{-4}/^\circ\text{C}$		V
		min.	max.				min.	max.	
AZ23B2V7-V	D1	2.65	2.75	75 (< 83)	< 500	5	- 9	- 4	-
AZ23B3V0-V	D2	2.94	3.06	80 (< 95)	< 500	5	- 9	- 3	-
AZ23B3V3-V	D3	3.23	3.37	80 (< 95)	< 500	5	- 8	- 3	-
AZ23B3V6-V	D4	3.53	3.67	80 (< 95)	< 500	5	- 8	- 3	-
AZ23B3V9-V	D5	3.82	3.98	80 (< 95)	< 500	5	- 7	- 3	-
AZ23B4V3-V	D6	4.21	4.39	80 (< 95)	< 500	5	- 6	- 1	-
AZ23B4V7-V	D7	4.61	4.79	70 (< 78)	< 500	5	- 5	2	-
AZ23B5V1-V	D8	5	5.2	30 (< 60)	< 480	5	- 3	4	> 0.8
AZ23B5V6-V	D9	5.49	5.71	10 (< 40)	< 400	5	- 2	6	> 1
AZ23B6V2-V	D10	6.08	6.32	4.8 (< 10)	< 200	5	- 1	7	> 2
AZ23B6V8-V	D11	6.66	6.94	4.5 (< 8)	< 150	5	2	7	> 3
AZ23B7V5-V	D12	7.35	7.65	4 (< 7)	< 50	5	- 3	7	> 5
AZ23B8V2-V	D13	8.04	8.36	4.5 (< 7)	< 50	5	4	7	> 6
AZ23B9V1-V	D14	8.92	9.28	4.8 (< 10)	< 50	5	5	8	> 7
AZ23B10-V	D15	9.8	10.2	5.2 (< 15)	< 70	5	5	8	> 7.5
AZ23B11-V	D16	10.8	11.2	6 (< 20)	< 70	5	5	9	> 8.5
AZ23B12-V	D17	11.8	12.2	7 (< 20)	< 90	5	6	9	> 9
AZ23B13-V	D18	12.7	13.3	9 (< 25)	< 110	5	7	9	> 10
AZ23B15-V	D19	14.7	15.3	11 (< 30)	< 110	5	7	9	> 11
AZ23B16-V	D20	15.7	16.3	13 (< 40)	< 170	5	8	0.5	> 12
AZ23B18-V	D21	17.6	18.4	18 (< 50)	< 170	5	8	0.5	> 14
AZ23B20-V	D22	19.6	20.4	20 (< 50)	< 220	5	8	10	> 15
AZ23B22-V	D23	21.6	22.4	25 (< 55)	< 220	5	8	10	> 17
AZ23B24-V	D24	23.5	24.5	28 (< 80)	< 220	5	8	10	> 18
AZ23B27-V	D25	26.5	27.5	30 (< 80)	< 250	5	8	10	> 20
AZ23B30-V	D26	29.4	30.6	35 (< 80)	< 250	5	8	10	> 22.5
AZ23B33-V	D27	32.3	33.7	40 (< 80)	< 250	5	8	10	> 25
AZ23B36-V	D28	35.3	36.7	40 (< 90)	< 250	5	8	10	> 27
AZ23B39-V	D29	38.2	39.8	50 (< 90)	< 300	5	10	12	> 29
AZ23B43-V	D30	42.1	43.9	60 (< 100)	< 700	5	10	12	> 32
AZ23B47-V	D31	46.1	47.9	70 (< 100)	< 750	5	10	12	> 35
AZ23B51-V	D32	50	52	70 (< 100)	< 750	5	10	12	> 38

**Note**

<sup>1)</sup> Tested with pulses  $t_p = 5 \text{ ms}$

## Typical Characteristics ( $T_{amb} = 25\text{ }^{\circ}\text{C}$ , unless otherwise specified)

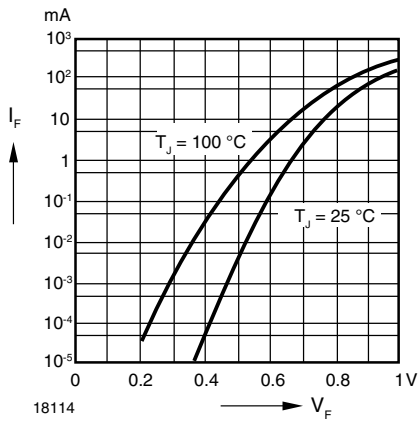

Figure 1. Forward characteristics

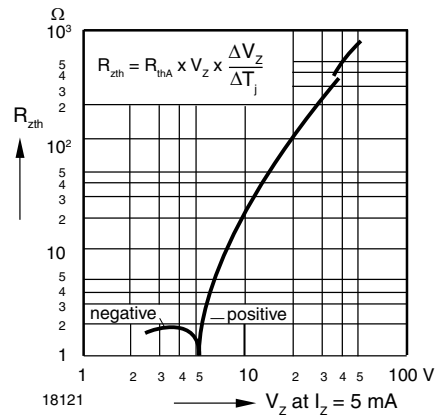

Figure 4. Thermal Differential Resistance vs. Zener Voltage

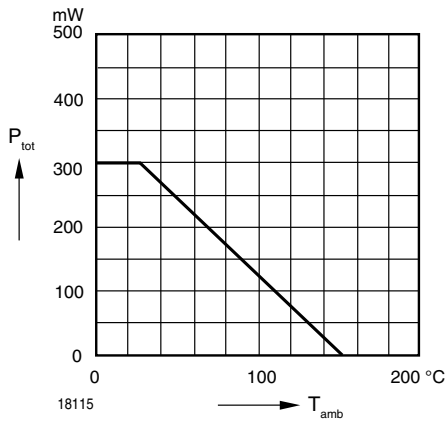

Figure 2. Admissible Power Dissipation vs. Ambient Temperature

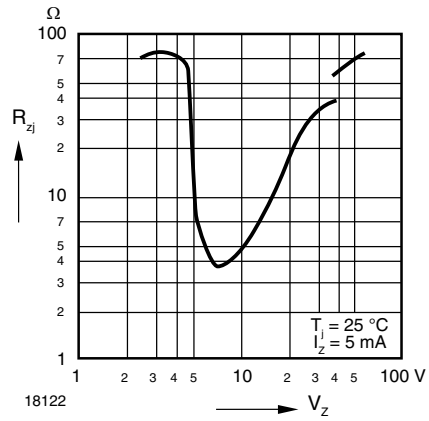

Figure 5. Dynamic Resistance vs. Zener Voltage

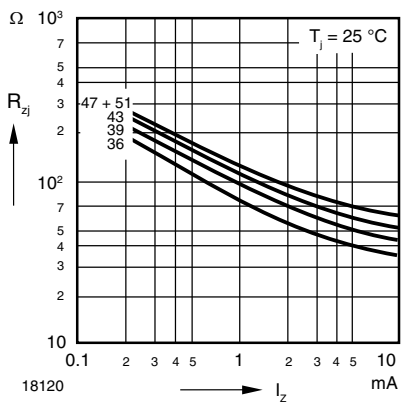

Figure 3. Dynamic Resistance vs. Zener Current

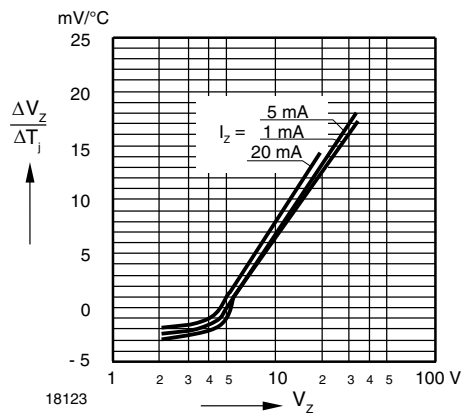

Figure 6. Temperature Dependence of Zener Voltage vs. Zener Voltage

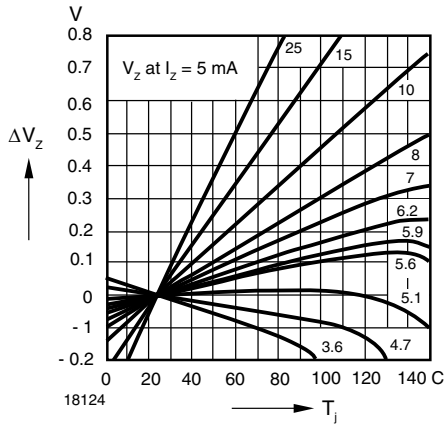

Figure 7. Change of Zener Voltage vs. Junction Temperature

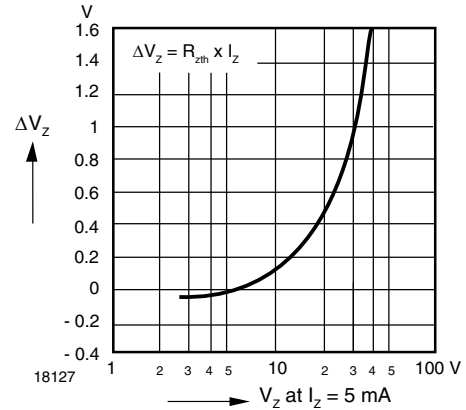

Figure 10. Change of Zener Voltage from Turn-on up to the Point of Thermal Equilibrium vs. Zener Voltage

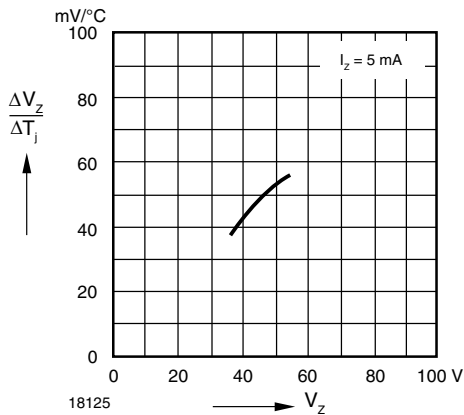

Figure 8. Temperature Dependence of Zener Voltage vs. Zener Voltage

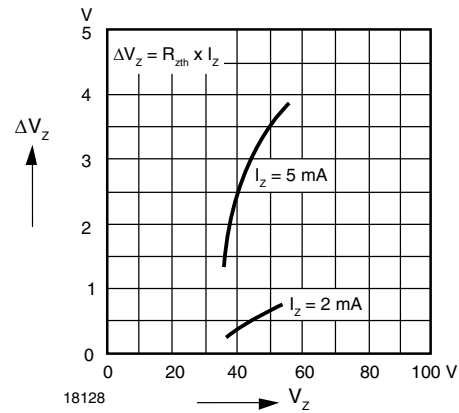

Figure 11. Change of Zener Voltage from Turn-on up to the Point of Thermal Equilibrium vs. Zener Voltage

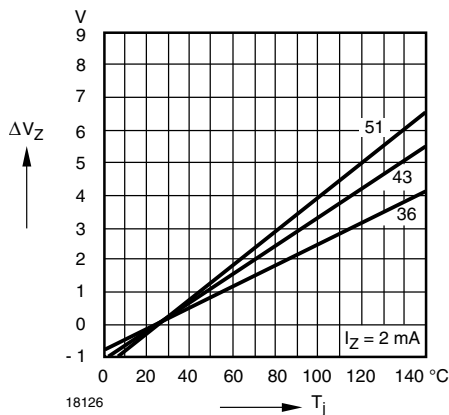

Figure 9. Change of Zener Voltage vs. Junction Temperature

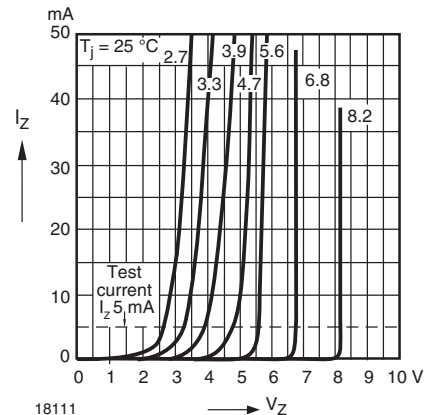

Figure 12. Breakdown Characteristics

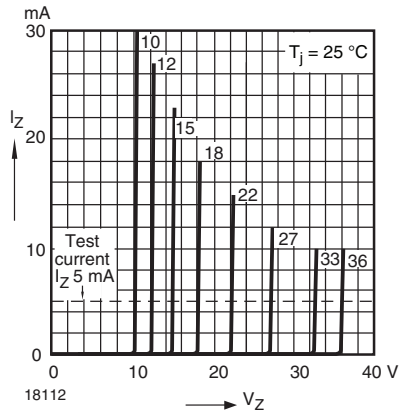

Figure 13. Breakdown Characteristics

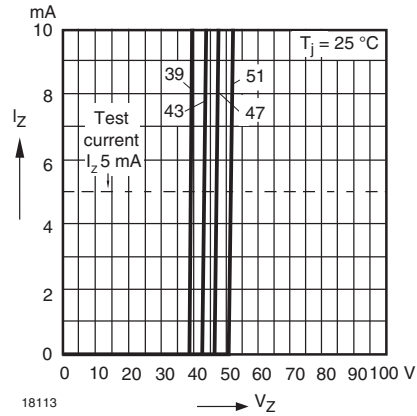
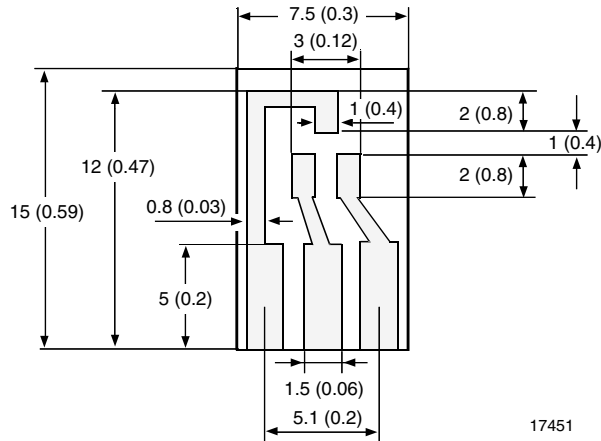

Figure 14. Breakdown Characteristics

## Layout for $R_{thJA}$ test

Thickness: Fiberglass 0.059 inches (1.5 mm)  
Copper leads 0.012 inches (0.3 mm)



17451

## Package Dimensions in millimeters (inches): SOT-23

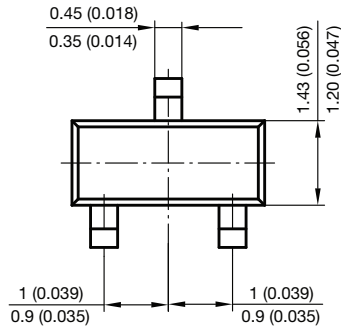
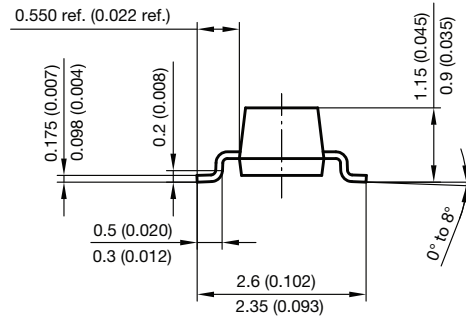
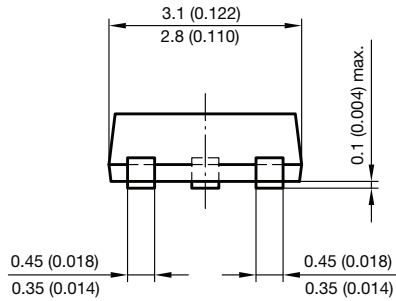

Foot print recommendation:

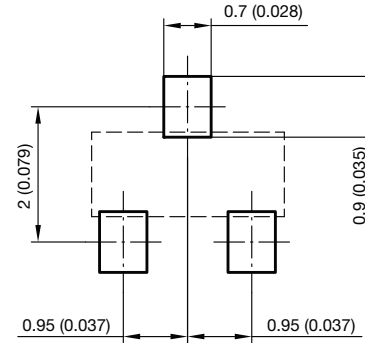

Document no.: 6.541-5014.01-4

Rev. 8 - Date: 23.Sept.2009

17418



## Disclaimer

ALL PRODUCT, PRODUCT SPECIFICATIONS AND DATA ARE SUBJECT TO CHANGE WITHOUT NOTICE TO IMPROVE RELIABILITY, FUNCTION OR DESIGN OR OTHERWISE.

Vishay Intertechnology, Inc., its affiliates, agents, and employees, and all persons acting on its or their behalf (collectively, "Vishay"), disclaim any and all liability for any errors, inaccuracies or incompleteness contained in any datasheet or in any other disclosure relating to any product.

Vishay makes no warranty, representation or guarantee regarding the suitability of the products for any particular purpose or the continuing production of any product. To the maximum extent permitted by applicable law, Vishay disclaims (i) any and all liability arising out of the application or use of any product, (ii) any and all liability, including without limitation special, consequential or incidental damages, and (iii) any and all implied warranties, including warranties of fitness for particular purpose, non-infringement and merchantability.

Statements regarding the suitability of products for certain types of applications are based on Vishay's knowledge of typical requirements that are often placed on Vishay products in generic applications. Such statements are not binding statements about the suitability of products for a particular application. It is the customer's responsibility to validate that a particular product with the properties described in the product specification is suitable for use in a particular application. Parameters provided in datasheets and/or specifications may vary in different applications and performance may vary over time. All operating parameters, including typical parameters, must be validated for each customer application by the customer's technical experts. Product specifications do not expand or otherwise modify Vishay's terms and conditions of purchase, including but not limited to the warranty expressed therein.

Except as expressly indicated in writing, Vishay products are not designed for use in medical, life-saving, or life-sustaining applications or for any other application in which the failure of the Vishay product could result in personal injury or death. Customers using or selling Vishay products not expressly indicated for use in such applications do so at their own risk and agree to fully indemnify and hold Vishay and its distributors harmless from and against any and all claims, liabilities, expenses and damages arising or resulting in connection with such use or sale, including attorneys fees, even if such claim alleges that Vishay or its distributor was negligent regarding the design or manufacture of the part. Please contact authorized Vishay personnel to obtain written terms and conditions regarding products designed for such applications.

No license, express or implied, by estoppel or otherwise, to any intellectual property rights is granted by this document or by any conduct of Vishay. Product names and markings noted herein may be trademarks of their respective owners.