

BALLUFF

sensors worldwide



BSP Pressure Sensors

Reliable solutions for the automation industry



more added value



BSP Pressure Sensors

Reliable Solutions for
the Automation Industry



With over 50 years of sensor experience, Balluff is a leading global sensor specialist with its own line of connectivity products for every area of factory automation. Balluff is based in Germany and has a tight international network of 54 representatives and subsidiaries.

Balluff stands for comprehensive systems from a single source, continuous innovation, state-of-the-art technology, highest quality and greatest reliability and prides itself on distinctive customer orientation, custom-tailored solutions, fast worldwide service and outstanding application assistance.

High-quality, innovative products and a quality management system certified according to DIN ISO 9001 (EN 2008) form a secure foundation for optimized added value for our customers.

Whether electronic and mechanical sensors, rotary and linear transducers, identification systems or optimized connection technology for high-performance automation, Balluff masters not only the entire technological variety with all of the different operating principles, but also provides technology that fulfills regional quality standards and is suitable for use worldwide. Wherever you are in the world, Balluff technology is never far away. You won't have to look far for you nearest Balluff expert.

Balluff products increase performance, quality and productivity around the world every day. They satisfy prerequisites for meeting demands for greater performance and cost reductions on the global market. Even in the most demanding areas. No matter how stringent your requirements may be, Balluff delivers state-of-the-art solutions.

**Advanced technology,
individual solutions:
high quality for
greater efficiency.**



more added value

- The right product selection for your application
- Outstanding price/performance ratio
- Especially user-friendly

BSP Pressure Sensors

Reliable Solutions for
the Automation Industry

BSP pressure sensors from Balluff were designed for measuring the pressure of gases and liquids. A rotary housing and two-button programming make these sensors flexible to install and easy to operate. The bright LED display provides up-to-date information on the current system pressure.

Basic Information and Definitions 8

BSP Pressure Sensors

Standard sensors 14
High-end sensors 16

Accessories

Adapters 18
Connectors 19

Alphanumerical directory 20
Worldwide sales 22



i

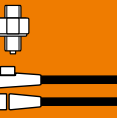

BSP Pressure Sensors

Reliable Solutions for
the Automation Industry

BSP pressure sensors from Balluff guarantee the consistently high quality of your products.

Process technology is becoming more and more important in the factory automation sector. The monitoring of process materials such as cooling lubricant, hydraulic and pneumatic fluids has an important influence on production quality. BSP pressure sensors from Balluff guarantee the consistently high quality of your products.

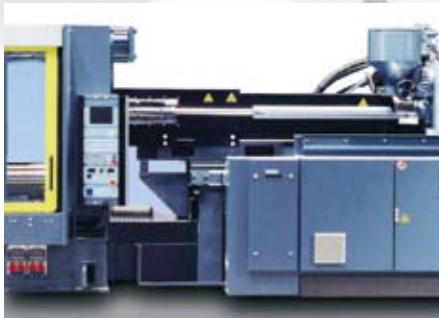



BSP Pressure Sensors

Reliable Solutions for the Automation Industry

i

- Save space when positioning the versatile sensor in the switching cabinet – the exceptionally compact sensor has independently rotating display and connection housings.
- View the system pressure at a glance – Balluff pressure sensors have a large, brightly illuminated LED display.
- Clear menu navigation for the quick and easy adjustment of pressure parameters – configure the sensor using 2 buttons in line with VDMA standards.
- Also suitable for harsh industrial applications – Balluff offers high-end versions in a high-quality, hard-wearing stainless steel housing with degree of protection IP 67.
- Reliable operation of your plants even under demanding conditions (pressure peaks) – reliable ceramic measuring cells guarantee long-term stability and durability.
- Simple installation with globally standardized screw fittings – process connection via a G 1/4" internal thread and adapter available in different sizes and versions.
- Find the right sensor for your application – Balluff offers versions with two switching points or with one switching point and one analog output.

Application areas

- Hydraulics
- Pneumatics
- Machine tools
- Plastics technology
- Packaging machines
- Wind turbines
- Off-shore

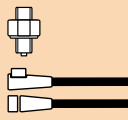

Type	Standard	High-End
From page	14	16
Housing material		
Plastic	■	
Stainless steel		■
Special properties		
Standard temperature range -25...+85 °C	■	■
Increased temperature range -40...+85 °C		■
Display housing rotates 320°	■	■
Connection housing with M12 plug rotates 320°	■	■
Application areas and applications		
Hydraulics	■	■
Pneumatics	■	■
Machine tools	■	■
Plastics technology	■	■
Packaging machines	■	■
Wind turbines		■
Off-shore		■

Multi-talented: BSP Balluff pressure sensors combine the advantages of a display, measuring transducer and pressure switch in a single device.

Holding pressure switchover on injection molding machines

Balluff BSP pressure sensors measure the hydraulic pressure of the screw drive in order to regulate the switchover point between the injection and holding pressure systems. Controlling this parameter with a high degree of precision is a crucial factor in achieving dimensional accuracy and quality of the products manufactured. A BSP pressure sensor with analog output monitors the available hydraulic pressure in order to control the process accurately while achieving a satisfactory degree of repeatability.

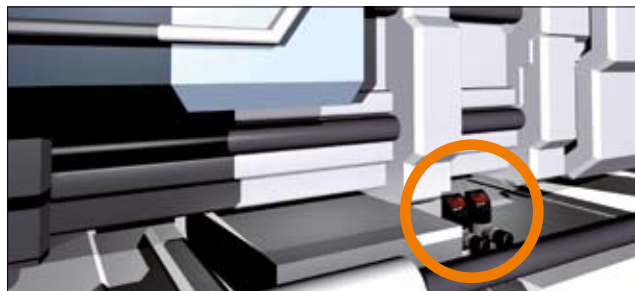
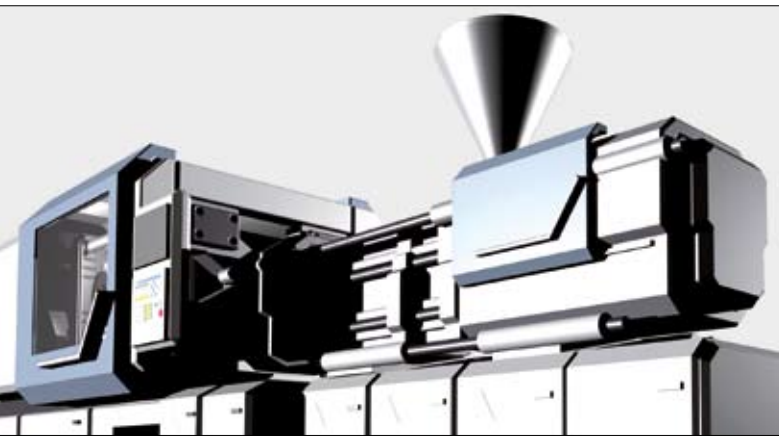

Benefits

- Switching point and analog output (0...10 V or 4...20 mA)
- Degree of protection IP 67
- Consistent quality of workpieces

Coolant monitoring on machine tools

The pressure in the coolant supply system must be monitored continually to guarantee the consistently high surface quality of machined workpieces. Balluff BSP pressure sensors can monitor the pressure level and shut down the machine within a few milliseconds if the system pressure exceeds the defined limits.



Benefits

- Ceramic measuring cells offer stability in the long term
- Display is easy to read
- Reliable machine operation

BSP Pressure Sensors

Applications

i

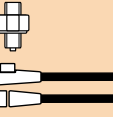

Central hydraulic unit on wind turbines

Many central systems on a wind turbine such as the pitch control and braking system are operated hydraulically. The high-end version of the BSP measures the actual system pressure reliably, even under harsh ambient conditions. The pump motor can be controlled directly via two programmable switching points to prevent the oil pressure from exceeding the maximum or minimum permitted levels.

Vacuum grippers

Vacuum grippers are used for a wide variety of material handling tasks. The grippers must be able to adapt to different materials and workpieces and operate continuously without error. Balluff BSP pressure sensors designed for vacuum applications are used to monitor the pressure of the vacuum suckers and make sure they grip reliably.



Benefits

- Compact housing
- Simple installation
- Vacuum sensors up to -1 bar relative pressure



Benefits

- Extended temperature range to -40 °C
- Two programmable switching points
- Increased system availability

Basic Information and Definitions

Sensor design

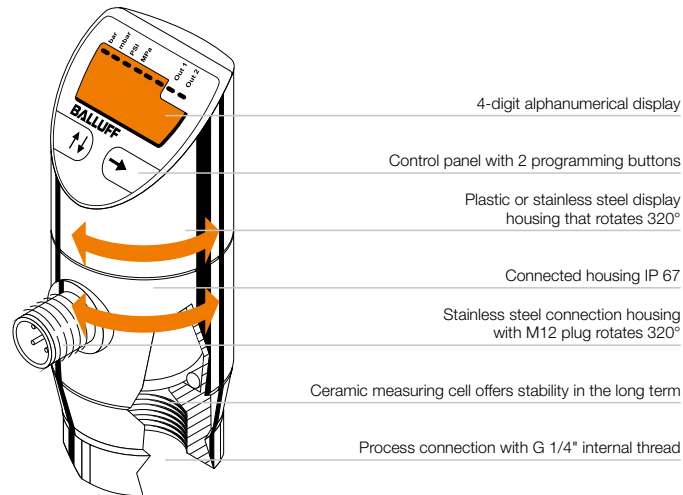

Principle of operation

Balluff pressure sensors convert the physical pressure variable (force per surface) into an electrical output variable that serves as a pressure indicator. BSP Balluff pressure sensors use a ceramic membrane to perform this conversion process. The electrical signal is amplified and linearized and interfering factors such as temperature are compensated.

Pressure characteristics

Absolute pressure: the absolute pressure is the pressure in relation to zero pressure (vacuum). The value range of absolute pressure is always positive.

Relative pressure: pressure is usually measured in relation to the relevant atmospheric pressure. Measuring pressures greater than air pressure always produces positive values. Pressures lower than air pressure produce negative values.

Nominal pressure: corresponds to the maximum design pressure.

Cracking pressure: minimum pressure that the pressure sensor must withstand without being destroyed. If this pressure is exceeded, it is certain that pressurized components will burst, the device will begin to leak or internal mechanisms will be destroyed.

Pressure peaks: pressure load pulses that can be several times the measured pressure.

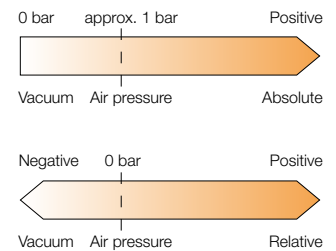

Material characteristics

Incompressible material: changes in the pressure of fluids such as water and hydraulic fluid do not initially have an effect on volume. These materials are classed as incompressible.

Compressible material: typical compressible materials include gases, which decrease in volume when their pressure increases.

Material temperature: indicates the permitted temperature range of the pressurized material.



Characteristic

Describes the relationship between the measured and output variable. On pressure sensors, the characteristic indicates how dependent the output signal is on the pressure. In an ideal scenario, the characteristic should be a straight line.

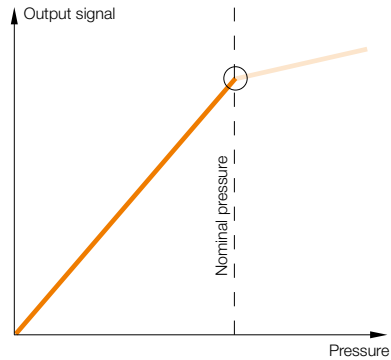

Accuracy

The accuracy indicates how much the actual characteristic can deviate from the ideal characteristic (according to IEC 60770 non-linearity, Hysteresis and repeatability). Accuracy specifications represent a percentage value of the measurement range (FSO) and never include dimensions.

Nominal pressure 50 bar
Accuracy 0.5 %
Max. deviation 0.25 bar

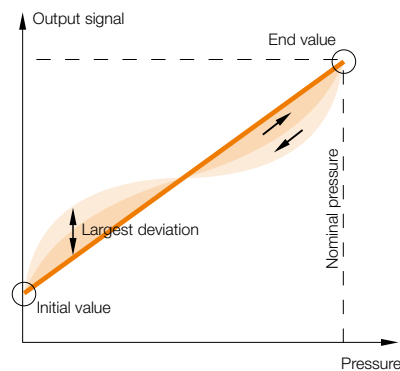

Measuring range

Working range with specific tolerances within which the measured deviation lies.

Full scale end value (FS)

Maximum measuring variable to which a device is adjusted, e.g. 20 mA.

Full scale output (FSO)

The range represents the difference between the upper and lower limit values of the display range. Example: a pressure sensor with a measuring range of 0...6 bar and a corresponding output signal of 4...20 mA has an FSO of 16 mA

Response time

The time between the change in pressure and the change in the switching output status.

Repeatability

Repeat accuracy of two measurements under standardized conditions.

Basic Information and Definitions

Hysteresis, adjustable

The difference between the switching point (SP) and return point (RP) is known as a hysteresis. On electronic pressure switches, any hysteresis can be selected within the measuring range.

Hysteresis function: the hysteresis keeps the switching status of the outputs stable, even if the system pressure fluctuates either side the setpoint value. The output is activated when the system pressure rises and the relevant switching point (SP) is reached. The output is deactivated when the pressure decreases again and the return point (RP) is reached.

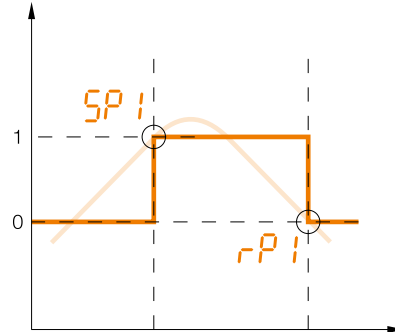

Window, adjustable

The output function is activated when the measured value falls between the preset switching and return point.

Window function: the range between a defined lower pressure limit and a defined upper limit is known as a window. A switching operation is initiated as soon as the upper or lower limit of the programmed pressure range is exceeded.

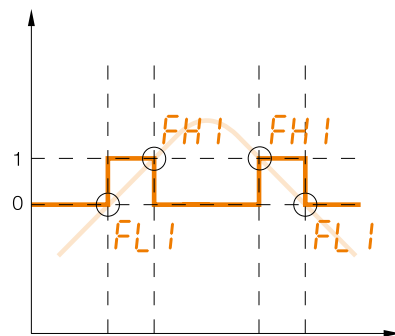

Delay times

Delay times can reliably filter out undesired pressure peaks that occur momentarily. The status of the switching output does not change immediately after the switching event occurs, but only once a preselected delay time of 0...50 s has elapsed. If the switching event no longer exists by the time the delay has elapsed, the switching output does not change.

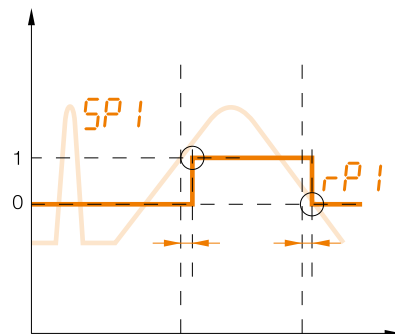



Switching function

4-wire pressure sensors with switching output

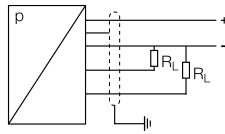

4-wire pressure sensors with analog output

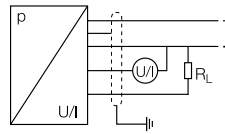

Pin assignments

Electrical connections	Pressure sensors with switching output	Pressure sensors with analog output
Supply +	1	1
Supply -	3	3
Signal +		2
Switching output 1	4	4
Switching output 2	2	
Shield	Connector housing	Connector housing

Operating voltage U_B

is the voltage range in which flawless functioning of the sensor is assured. It includes all voltage tolerances and ripple.

Output current max.

is the maximum current with which the output of the sensor may be loaded in continuous operation.

No-load supply current I_0 max.

is the power consumption of the sensor with a maximum operating voltage U_O and with no connected load.

Short-circuit protection and overload protection

All DC sensors feature this protection device. In the event of overload or short-circuit at the output, the output transistor is automatically switched off. As soon as the malfunction has been corrected, the output stage is reset to normal functioning.

Polarity reversal protection

The sensor electronics are protected against possible polarity reversal or interchanging of the connection wires.

Ambient temperature range T_a

The device operates reliably within this temperature range. The ambient temperature range of the device must remain within the range specified on the relevant data sheet and should not exceed the upper or lower range limits.

Temperature drift

When changes in the ambient temperature range cause the switching point to shift.

Switching frequency f max.

is a succession of periodically repeated sensor switching cycles that occur during one second.

Basic Information and Definitions

Materials

Material	Use and characteristics
Plastics	
PA 6.6 polyamide	Good mechanical strength. Temperature resistance.
FKM Fluoroelastomer	Resistant to pressure deformation. Temperature resistance. Good chemical resistance.
PUR Polyurethane	Elastic, abrasion-resistant, impact-resistant. Good resistance to oils, greases, solvents (used for gaskets and cable jackets).
PVC Polyvinylchloride	Good mechanical strength. Chemical resistance (cable).
Metal	
Stainless steel	Excellent corrosion resistance and strength. Quality 1.4301: Standard material for the foods industry.
Other	
Ceramic	Very good strength and chemical resistance. Electrically insulating. Excellent temperature resistance.

Degree of protection

The enclosure ratings IP 20, IP 40, IP 54, IP 64 up to IP 68 are in accordance with IEC 60529. Code letters IP (International Protection) designate protection against shock hazard, ingress of solid foreign bodies, and water, for electrical equipment.

First digit:

- 2 Protection against penetration of solid bodies larger than 12 mm, shielding from fingers and objects
- 4 Protection against penetration of solid bodies larger than 1 mm, shielding from tools and wires
- 5 Protection against harmful dust deposits, complete shock-hazard protection
- 6 Protection against penetration of dust, complete shock-hazard protection

Second digit:

- 0 No special protection
- 4 Protection against water spraying from all directions against the piece of equipment concerned
- 5 Protection against a water jet from a nozzle directed towards the piece of equipment concerned from any direction
- 7 Protection against water, when the piece of equipment concerned (housing) is immersed in water under specified pressure and time conditions
- 8 Protection against water during continuous submersion

Display

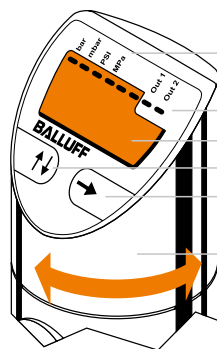

Different pressure units can be selected

Function ready/error indicator

Luminous, 4-digit, 7-segment display

Change menus and adjust parameters

Display parameters

Plastic or stainless steel display housing that rotates 320°

Description	ASCII	Description	ASCII
SP:1	SP1	Hn:0	NO with hysteresis function
rP:1	RP1	Fno:0	NO with window function
SP:2	SP2	Hnc:0	NC with hysteresis function
rP:2	RP2	Fnc:0	NC with window function
FH:1	FH1	Uni:0	Unit selection
FL:1	FL1	bar:0	Unit bar
FH:2	FH2	MPa:0	Unit MPa
FL:2	FL2	Pa:0	Unit Pa
EF:0	EF	psi:0	Unit psi
rES:0	RES	Lo:0	Min. value
dS:1	dS1	Hi:0	Max. value
dS:2	dS2	di:R	Diagnostic function
dr:1	dr1	Err:0	Error indicator
dr:2	dr2	di:S	Display
ou:1	Ou1	PE:0	Yes
ou:2	Ou2	no:0	No



Setting and adjusting parameters

Balluff BSP pressure sensors are easy to configure in line with VDMA standards: **Change menu** – Press the button to switch to programming mode and modify the pressure sensor settings.

Display parameters – Press the button to show the relevant parameter on the display. **Set parameter** – Press the button in any menu to select the relevant value.

Display mode

The current process pressure is displayed here. You can check this parameter directly on location at any time.



Switching point 1

Here you can select the switching point (pressure value) of output 1, which determines when the output status of the sensor changes. The switching point can be set to any value within the measuring range.



Return point 1

Return point 1 is used to select the pressure value that defines when output 1 switches back. The difference between SP 1 (9.05 bar here) and RP 1 (7.05 bar here) produces the hysteresis (2 bar here) of switching output 1.



Switching point 2

For setting output 2. Proceed as described for switching point 1.



Return point 2

For setting output 2. Proceed as described for return point 1.



Extended functions

Additional settings such as switching functions for outputs 1 and 2 can be configured in the "Extended functions" menu.



BSP Pressure Sensors

Standard Sensors

Standard Balluff pressure sensors offer an impressive price/performance ratio and are suitable for a wide variety of applications in factory automation. A large display and simple operating concept save time when configuring parameters. These Balluff pressure sensors are versatile and space-saving. The display and electrical output can be rotated independently of the flange. Other features of these sensors include:

- A compact housing design
- A local pressure indicator
- Digital switching outputs
- Analog output signals



Pressure sensors are found in many mechanical engineering applications. Different versions with switching points, an analog output and a variety of pressure ranges mean you are guaranteed to find the right sensor for your application.

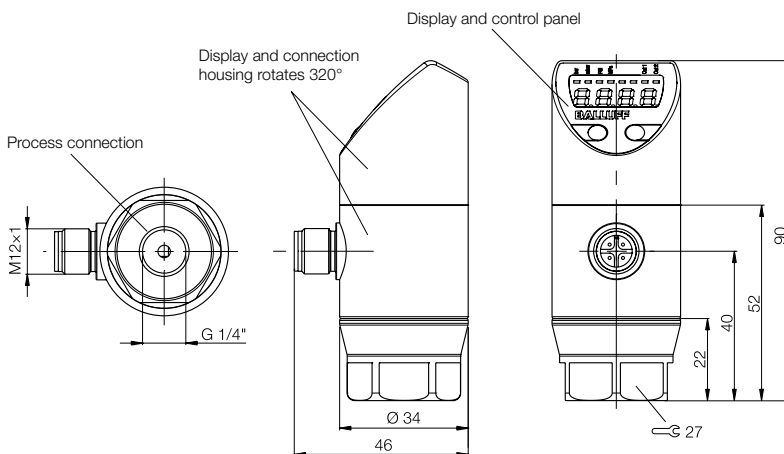

Design	Relative nominal pressure	Overload pressure	Cracking pressure \geq	Permitted vacuum
Pressure sensors -1...2 bar	2 bar	4 bar	10 bar	vacuum proof
Pressure sensors -1...10 bar	10 bar	20 bar	35 bar	
Pressure sensors 0...2 bar	2 bar	4 bar	10 bar	
Pressure sensors 0...5 bar	5 bar	10 bar	15 bar	
Pressure sensors 0...10 bar	10 bar	20 bar	35 bar	
Pressure sensors 0...20 bar	20 bar	40 bar	75 bar	
Pressure sensors 0...50 bar	50 bar	100 bar	150 bar	
Pressure sensors 0...100 bar	100 bar	200 bar	250 bar	
Pressure sensors 0...250 bar	250 bar	400 bar	450 bar	
Pressure sensors 0...400 bar	400 bar	650 bar	700 bar	
Pressure sensors 0...600 bar	600 bar	750 bar	800 bar	

-1...2 bar -14.5...29 psi	PNP	Ordering code	
		Part number	
	NPN	Ordering code	
		Part number	
-1...10 bar -14.5...145 psi	PNP	Ordering code	
		Part number	
	NPN	Ordering code	
		Part number	
0...2 bar 0...29 psi	PNP	Ordering code	
		Part number	
	NPN	Ordering code	
		Part number	
0...5 bar 0...73 psi	PNP	Ordering code	
		Part number	
	NPN	Ordering code	
		Part number	
0...10 bar 0...145 psi	PNP	Ordering code	
		Part number	
	NPN	Ordering code	
		Part number	
0...20 bar 0...290 psi	PNP	Ordering code	
		Part number	
	NPN	Ordering code	
		Part number	
0...50 bar 0...725 psi	PNP	Ordering code	
		Part number	
	NPN	Ordering code	
		Part number	
0...100 bar 0...1450 psi	PNP	Ordering code	
		Part number	
	NPN	Ordering code	
		Part number	
0...250 bar 0...3626 psi	PNP	Ordering code	
		Part number	
	NPN	Ordering code	
		Part number	
0...400 bar 0...5802 psi	PNP	Ordering code	
		Part number	
	NPN	Ordering code	
		Part number	
0...600 bar 0...8702 psi	PNP	Ordering code	
		Part number	
	NPN	Ordering code	
		Part number	

Operating voltage U_B
 Output current max.
 No-load supply current I_0 max.
 Switching frequency f max.
 Accuracy

Temperature error
 Reverse polarity/short-circuit protected
 Ambient/material temperature
 Display/function indicators
 Degree of protection per IEC 60529

Material
 Housing
 Measuring cell
 Seal

Connection
 Connectors
 Process connection

BSP Pressure Sensors

Standard sensors



2 programmable switching points (NO or NC)



1 programmable switching point and analog output 0...10 V DC



1 programmable switching point and analog output 4...20 mA

BSP004F BSP V002-EV002-D00A0B-S4	BSP004J BSP V002-EV002-A00A0B-S4	BSP004L BSP V002-EV002-A02A0B-S4
BSP004N BSP V002-EV002-D01A0B-S4	BSP004R BSP V002-EV002-A01A0B-S4	BSP004U BSP V002-EV002-A03A0B-S4
BSP004H BSP V010-EV002-D00A0B-S4	BSP004K BSP V010-EV002-A00A0B-S4	BSP004M BSP V010-EV002-A02A0B-S4
BSP004P BSP V010-EV002-D01A0B-S4	BSP004T BSP V010-EV002-A01A0B-S4	BSP004W BSP V010-EV002-A03A0B-S4
BSP000F BSP B002-EV002-D00A0B-S4	BSP000T BSP B002-EV002-A00A0B-S4	BSP0014 BSP B002-EV002-A02A0B-S4
BSP003K BSP B002-EV002-D01A0B-S4	BSP003P BSP B002-EV002-A01A0B-S4	BSP003W BSP B002-EV002-A03A0B-S4
BSP000H BSP B005-EV002-D00A0B-S4	BSP000U BSP B005-EV002-A00A0B-S4	BSP0015 BSP B005-EV002-A02A0B-S4
BSP003L BSP B005-EV002-D01A0B-S4	BSP003R BSP B005-EV002-A01A0B-S4	BSP003Y BSP B005-EV002-A03A0B-S4
BSP000J BSP B010-EV002-D00A0B-S4	BSP000W BSP B010-EV002-A00A0B-S4	BSP0016 BSP B010-EV002-A02A0B-S4
BSP001F BSP B010-EV002-D01A0B-S4	BSP001M BSP B010-EV002-A01A0B-S4	BSP001U BSP B010-EV002-A03A0B-S4
BSP000K BSP B020-EV002-D00A0B-S4	BSP000Y BSP B020-EV002-A00A0B-S4	BSP0017 BSP B020-EV002-A02A0B-S4
BSP001H BSP B020-EV002-D01A0B-S4	BSP001N BSP B020-EV002-A01A0B-S4	BSP001W BSP B020-EV002-A03A0B-S4
BSP000L BSP B050-EV002-D00A0B-S4	BSP000Z BSP B050-EV002-A00A0B-S4	BSP0018 BSP B050-EV002-A02A0B-S4
BSP001J BSP B050-EV002-D01A0B-S4	BSP001P BSP B050-EV002-A01A0B-S4	BSP001Y BSP B050-EV002-A03A0B-S4
BSP000M BSP B100-EV002-D00A0B-S4	BSP0010 BSP B100-EV002-A00A0B-S4	BSP0019 BSP B100-EV002-A02A0B-S4
BSP001K BSP B100-EV002-D01A0B-S4	BSP001R BSP B100-EV002-A01A0B-S4	BSP001Z BSP B100-EV002-A03A0B-S4
BSP000N BSP B250-EV002-D00A0B-S4	BSP0011 BSP B250-EV002-A00A0B-S4	BSP001A BSP B250-EV002-A02A0B-S4
BSP001L BSP B250-EV002-D01A0B-S4	BSP001T BSP B250-EV002-A01A0B-S4	BSP0020 BSP B250-EV002-A03A0B-S4
BSP000P BSP B400-EV002-D00A0B-S4	BSP0012 BSP B400-EV002-A00A0B-S4	BSP001C BSP B400-EV002-A02A0B-S4
BSP003M BSP B400-EV002-D01A0B-S4	BSP003T BSP B400-EV002-A01A0B-S4	BSP003Z BSP B400-EV002-A03A0B-S4
BSP000R BSP B600-EV002-D00A0B-S4	BSP0013 BSP B600-EV002-A00A0B-S4	BSP001E BSP B600-EV002-A02A0B-S4
BSP003N BSP B600-EV002-D01A0B-S4	BSP003U BSP B600-EV002-A01A0B-S4	BSP0040 BSP B600-EV002-A03A0B-S4
18...36 V DC 500 mA ≤ 50 mA 200 Hz ≤ ±0.5 % FSO BFSL ≤ ±0.3 % FSO/10 K Yes/yes -25...+85 °C/-25...+125 °C 7 segment display/LED IP 67 (when connected) PA 6.6, stainless steel Ceramic Fluoroelastomer M12 connector, 4-pin G 1/4"	18...36 V DC 500 mA ≤ 50 mA 200 Hz ≤ ±0.5 % FSO BFSL ≤ ±0.3 % FSO/10 K Yes/yes -25...+85 °C/-25...+125 °C 7 segment display/LED IP 67 (when connected) PA 6.6, stainless steel Ceramic Fluoroelastomer M12 connector, 4-pin G 1/4"	18...36 V DC 500 mA ≤ 50 mA 200 Hz ≤ ±0.5 % FSO BFSL ≤ ±0.3 % FSO/10 K Yes/yes -25...+85 °C/-25...+125 °C 7 segment display/LED IP 67 (when connected) PA 6.6, stainless steel Ceramic Fluoroelastomer M12 connector, 4-pin G 1/4"



Standard
Sensors
High-End
Sensors

BSP Pressure Sensors

High-End Sensors

Balluff pressure sensors for high-end applications were designed for demanding requirements and extended temperature ranges. The high-end pressure sensor is ideal for harsh environments. The compact housing is manufactured entirely from hard-wearing stainless steel. Parameters are configured quickly and easily in line with VDMA standards. High-end applications include:

- Wind turbines
- Off-shore
- Refrigeration and air-conditioning systems



The high-end version of the Balluff BSP is enclosed in a two-way rotary housing for easier installation. Position the cable outlet as shown in the machine layout and turn the display in your viewing direction.

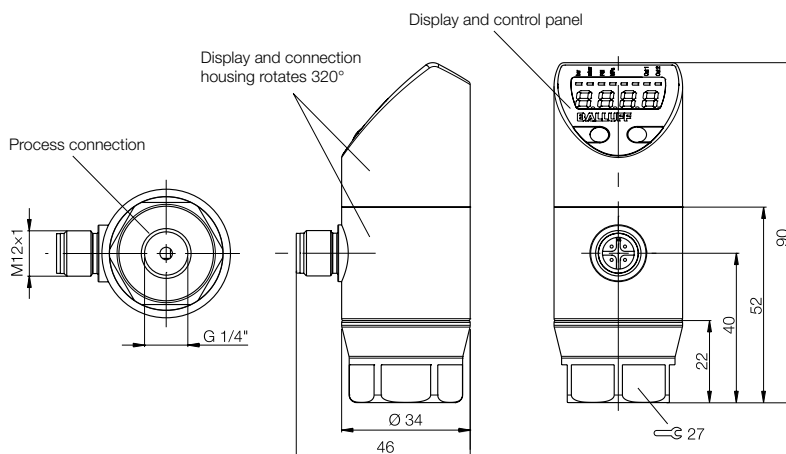

Design	Relative nominal pressure	Overload pressure	Cracking pressure \geq	Permitted vacuum
Pressure sensors -1...2 bar	2 bar	4 bar	10 bar	vacuum proof
Pressure sensors -1...10 bar	10 bar	20 bar	35 bar	
Pressure sensors 0...2 bar	2 bar	4 bar	10 bar	
Pressure sensors 0...5 bar	5 bar	10 bar	15 bar	
Pressure sensors 0...10 bar	10 bar	20 bar	35 bar	
Pressure sensors 0...20 bar	20 bar	40 bar	75 bar	
Pressure sensors 0...50 bar	50 bar	100 bar	150 bar	
Pressure sensors 0...100 bar	100 bar	200 bar	250 bar	
Pressure sensors 0...250 bar	250 bar	400 bar	450 bar	
Pressure sensors 0...400 bar	400 bar	650 bar	700 bar	
Pressure sensors 0...600 bar	600 bar	750 bar	800 bar	

-1...2 bar -14.5...29 psi	PNP	Ordering code	
		Part number	
	NPN	Ordering code	
		Part number	
-1...10 bar -14.5...145 psi	PNP	Ordering code	
		Part number	
	NPN	Ordering code	
		Part number	
0...2 bar 0...29 psi	PNP	Ordering code	
		Part number	
	NPN	Ordering code	
		Part number	
0...5 bar 0...73 psi	PNP	Ordering code	
		Part number	
	NPN	Ordering code	
		Part number	
0...10 bar 0...145 psi	PNP	Ordering code	
		Part number	
	NPN	Ordering code	
		Part number	
0...20 bar 0...290 psi	PNP	Ordering code	
		Part number	
	NPN	Ordering code	
		Part number	
0...50 bar 0...725 psi	PNP	Ordering code	
		Part number	
	NPN	Ordering code	
		Part number	
0...100 bar 0...1450 psi	PNP	Ordering code	
		Part number	
	NPN	Ordering code	
		Part number	
0...250 bar 0...3626 psi	PNP	Ordering code	
		Part number	
	NPN	Ordering code	
		Part number	
0...400 bar 0...5802 psi	PNP	Ordering code	
		Part number	
	NPN	Ordering code	
		Part number	
0...600 bar 0...8702 psi	PNP	Ordering code	
		Part number	
	NPN	Ordering code	
		Part number	

Operating voltage U_B
 Output current max.
 No-load supply current I_0 max.
 Switching frequency f max.
 Accuracy

Temperature error
 Reverse polarity/short-circuit protected
 Ambient/material temperature
 Display/function indicators
 Degree of protection per IEC 60529

Material
 Housing
 Measuring cell
 Seal

Connection
 Connectors
 Process connection

BSP Pressure Sensors

High-End Sensors



2 programmable switching points (NO or NC)



1 programmable switching point and analog output 0...10 V DC



1 programmable switching point and analog output 4...20 mA

BSP004Y BSP V002-EV003-D00A0B-S4	BSP0050 BSP V002-EV003-A00A0B-S4	BSP0052 BSP V002-EV003-A02A0B-S4
BSP0054 BSP V002-EV003-D01A0B-S4	BSP0056 BSP V002-EV003-A01A0B-S4	BSP0058 BSP V002-EV003-A03A0B-S4
BSP004Z BSP V010-EV003-D00A0B-S4	BSP0051 BSP V010-EV003-A00A0B-S4	BSP0053 BSP V010-EV003-A02A0B-S4
BSP0055 BSP V010-EV003-D01A0B-S4	BSP0057 BSP V010-EV003-A01A0B-S4	BSP0059 BSP V010-EV003-A03A0B-S4
BSP0021 BSP B002-EV003-D00A0B-S4	BSP002A BSP B002-EV003-A00A0B-S4	BSP002N BSP B002-EV003-A02A0B-S4
BSP0041 BSP B002-EV003-D01A0B-S4	BSP0045 BSP B002-EV003-A01A0B-S4	BSP0049 BSP B002-EV003-A03A0B-S4
BSP0022 BSP B005-EV003-D00A0B-S4	BSP002C BSP B005-EV003-A00A0B-S4	BSP002P BSP B005-EV003-A02A0B-S4
BSP0042 BSP B005-EV003-D01A0B-S4	BSP0046 BSP B005-EV003-A01A0B-S4	BSP004A BSP B005-EV003-A03A0B-S4
BSP0023 BSP B010-EV003-D00A0B-S4	BSP002E BSP B010-EV003-A00A0B-S4	BSP002R BSP B010-EV003-A02A0B-S4
BSP0031 BSP B010-EV003-D01A0B-S4	BSP0036 BSP B010-EV003-A01A0B-S4	BSP003C BSP B010-EV003-A03A0B-S4
BSP0024 BSP B020-EV003-D00A0B-S4	BSP002F BSP B020-EV003-A00A0B-S4	BSP002T BSP B020-EV003-A02A0B-S4
BSP0032 BSP B020-EV003-D01A0B-S4	BSP0037 BSP B020-EV003-A01A0B-S4	BSP003E BSP B020-EV003-A03A0B-S4
BSP0025 BSP B050-EV003-D00A0B-S4	BSP002H BSP B050-EV003-A00A0B-S4	BSP002U BSP B050-EV003-A02A0B-S4
BSP0033 BSP B050-EV003-D01A0B-S4	BSP0038 BSP B050-EV003-A01A0B-S4	BSP003F BSP B050-EV003-A03A0B-S4
BSP0026 BSP B100-EV003-D00A0B-S4	BSP002J BSP B100-EV003-A00A0B-S4	BSP002W BSP B100-EV003-A02A0B-S4
BSP0034 BSP B100-EV003-D01A0B-S4	BSP0039 BSP B100-EV003-A01A0B-S4	BSP003H BSP B100-EV003-A03A0B-S4
BSP0027 BSP B250-EV003-D00A0B-S4	BSP002K BSP B250-EV003-A00A0B-S4	BSP002Y BSP B250-EV003-A02A0B-S4
BSP0035 BSP B250-EV003-D01A0B-S4	BSP003A BSP B250-EV003-A01A0B-S4	BSP003J BSP B250-EV003-A03A0B-S4
BSP0028 BSP B400-EV003-D00A0B-S4	BSP002L BSP B400-EV003-A00A0B-S4	BSP002Z BSP B400-EV003-A02A0B-S4
BSP0043 BSP B400-EV003-D01A0B-S4	BSP0047 BSP B400-EV003-A01A0B-S4	BSP004C BSP B400-EV003-A03A0B-S4
BSP0029 BSP B600-EV003-D00A0B-S4	BSP002M BSP B600-EV003-A00A0B-S4	BSP0030 BSP B600-EV003-A02A0B-S4
BSP0044 BSP B600-EV003-D01A0B-S4	BSP0048 BSP B600-EV003-A01A0B-S4	BSP004E BSP B600-EV003-A03A0B-S4
18...36 V DC 500 mA ≤ 50 mA 200 Hz ≤ ±0.5 % FSO BFSL ≤ ±0.3 % FSO/10 K Yes/yes -40...+85 °C/-40...+125 °C 7 segment display/LED IP 67 (when connected) Stainless steel Ceramic Fluoroelastomer M12 connector, 4-pin G 1/4"	18...36 V DC 500 mA ≤ 50 mA 200 Hz ≤ ±0.5 % FSO BFSL ≤ ±0.3 % FSO/10 K Yes/yes -40...+85 °C/-40...+125 °C 7 segment display/LED IP 67 (when connected) Stainless steel Ceramic Fluoroelastomer M12 connector, 4-pin G 1/4"	18...36 V DC 500 mA ≤ 50 mA 200 Hz ≤ ±0.5 % FSO BFSL ≤ ±0.3 % FSO/10 K Yes/yes -40...+85 °C/-40...+125 °C 7 segment display/LED IP 67 (when connected) Stainless steel Ceramic Fluoroelastomer M12 connector, 4-pin G 1/4"



Standard Sensors
High-End Sensors

Accessories

Adapters



Description	Adapter G 1/4"	Adapter NPT 1/4"	Adapter G 1/4"
Version			for attachment to pressure gauge
Ordering code	BAM01KP	BAM01KT	BAM01KR
Part number	BAM AD-SP-008-1G4/1G4-4	BAM AD-SP-008-1G4/1N4-4	BAM AD-SP-008-1G4/1G4-4-EN837
Housing material	Stainless steel	Stainless steel	Stainless steel
Sensor end connection	G 1/4"	G 1/4"	G 1/4"
Process end connection	G 1/4"	NPT 1/4"	G 1/4" for attachment to pressure gauge as per EN 837

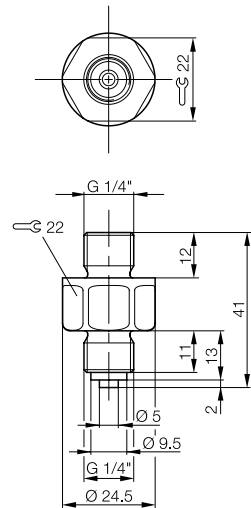
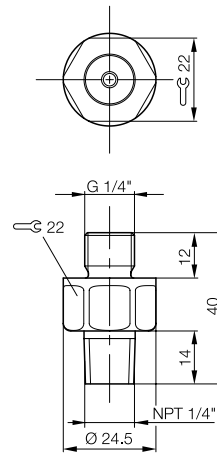
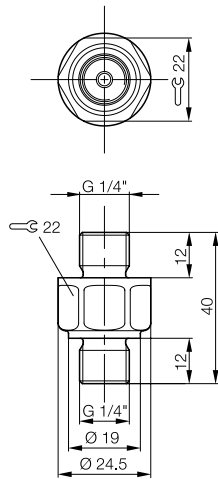

Balluff BSP pressure sensors can be adapted to different process connections using adapters available as an optional extra.

Adapters for other process connections are available on request.

Accessories

Connectors



ECOLAB

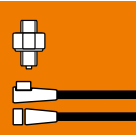

Adapters
Connectors

Version	Connection cable for standard pressure sensors	Connection cable for standard pressure sensors	Connection cable for high-end pressure sensors
Type	Straight female	Right-angle female	Straight female
Connector diagram and wiring	<p>PIN 1: brown PIN 2: white PIN 3: blue PIN 4: black</p>	<p>PIN 1: brown PIN 2: white PIN 3: blue PIN 4: black</p>	<p>PIN 1: brown PIN 2: white PIN 3: blue PIN 4: black</p>
Max. operating voltage U_0	250 V DC	250 V DC	32 V AC/DC
Cable	Molded	Molded	Assembled
No. of wires x conductor cross-section	4x0.34 mm ²	4x0.34 mm ²	4x0.34 mm ²
Degree of protection per IEC 60529	IP 68	IP 68	IP 68/IP 69K
Ambient temperature T_a	PUR: -25...+80 °C PVC: -5...+80 °C	-25...+80 °C -5...+80 °C	-40...+85 °C (momentarily +105 °C)

Cable material	Color	Length	Ordering code	Part number	
PUR	Black	2 m	BCC032F	BCC032Y	
			BCC M415-0000-1A-003-PX0434-020	BCC M425-0000-1A-003-PX0434-020	
PUR	Black	5 m	BCC032H	BCC032Z	
			BCC M415-0000-1A-003-PX0434-050	BCC M425-0000-1A-003-PX0434-050	
PUR	Black	10 m	BCC032J	BCC0330	
			BCC M415-0000-1A-003-PX0434-100	BCC M425-0000-1A-003-PX0434-100	
PVC	Gray	2 m	BCC0367	BCC036N	BCC02FE
			BCC M415-0000-1A-003-VX8434-020	BCC M425-0000-1A-003-VX8434-020	BKS-S260-3-02
PVC	Gray	5 m	BCC0368	BCC036P	BCC02FF
			BCC M415-0000-1A-003-VX8434-050	BCC M425-0000-1A-003-VX8434-050	BKS-S260-3-05
PVC	Gray	10 m	BCC0369	BCC036R	
			BCC M415-0000-1A-003-VX8434-100	BCC M425-0000-1A-003-VX8434-100	

Other cable materials, colors and lengths on request.

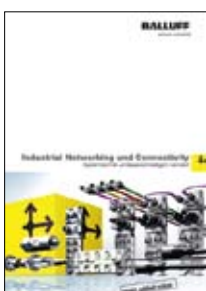
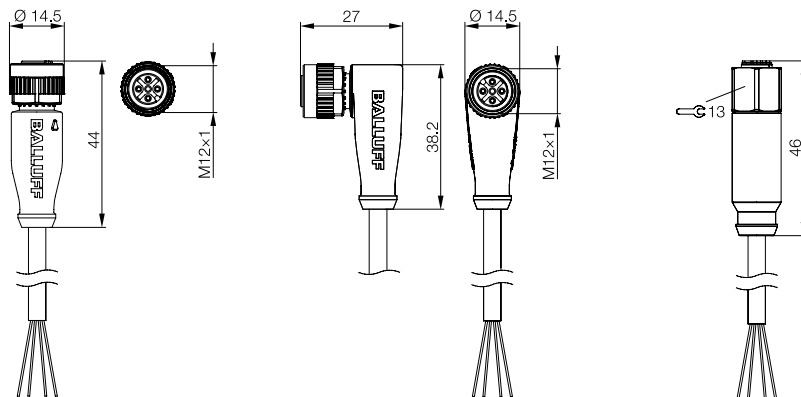

More about our cables and connectivity products can be found in our brochures or online at: www.balluff.com



Alphanumerical Directory



Sorted by Part number

Part number	Ordering code	Page	Part number	Ordering code	Page
BAM AD-SP-008-1G4/1G4-4	BAM01KP	18	BSP B050-EV003-D01A0B-S4	BSP0033	17
BAM AD-SP-008-1G4/1G4-4-EN837	BAM01KR	18	BSP B100-EV002-A00A0B-S4	BSP0010	15
BAM AD-SP-008-1G4/1N4-4	BAM01KT	18	BSP B100-EV002-A01A0B-S4	BSP001R	15
BCC M415-0000-1A-003-PX0434-020	BCC032F	19	BSP B100-EV002-A02A0B-S4	BSP0019	15
BCC M415-0000-1A-003-PX0434-050	BCC032H	19	BSP B100-EV002-A03A0B-S4	BSP001Z	15
BCC M415-0000-1A-003-PX0434-100	BCC032J	19	BSP B100-EV002-D00A0B-S4	BSP000M	15
BCC M415-0000-1A-003-VX8434-020	BCC0367	19	BSP B100-EV002-D01A0B-S4	BSP001K	15
BCC M415-0000-1A-003-VX8434-050	BCC0368	19	BSP B100-EV003-A00A0B-S4	BSP002J	17
BCC M415-0000-1A-003-VX8434-100	BCC0369	19	BSP B100-EV003-A01A0B-S4	BSP0039	17
BCC M425-0000-1A-003-PX0434-020	BCC032Y	19	BSP B100-EV003-A02A0B-S4	BSP002W	17
BCC M425-0000-1A-003-PX0434-050	BCC032Z	19	BSP B100-EV003-A03A0B-S4	BSP003H	17
BCC M425-0000-1A-003-PX0434-100	BCC0330	19	BSP B100-EV003-D00A0B-S4	BSP0026	17
BCC M425-0000-1A-003-VX8434-020	BCC036N	19	BSP B100-EV003-D01A0B-S4	BSP0034	17
BCC M425-0000-1A-003-VX8434-050	BCC036P	19	BSP B250-EV002-A00A0B-S4	BSP0011	15
BCC M425-0000-1A-003-VX8434-100	BCC036R	19	BSP B250-EV002-A01A0B-S4	BSP001T	15
BKS-S260-3-02	BCC02FE	19	BSP B250-EV002-A02A0B-S4	BSP001A	15
BKS-S260-3-05	BCC02FF	19	BSP B250-EV002-A03A0B-S4	BSP0020	15
BSP B002-EV002-A00A0B-S4	BSP000T	15	BSP B250-EV002-D00A0B-S4	BSP000N	15
BSP B002-EV002-A01A0B-S4	BSP003P	15	BSP B250-EV002-D01A0B-S4	BSP001L	15
BSP B002-EV002-A02A0B-S4	BSP0014	15	BSP B250-EV003-A00A0B-S4	BSP002K	17
BSP B002-EV002-A03A0B-S4	BSP003W	15	BSP B250-EV003-A01A0B-S4	BSP003A	17
BSP B002-EV002-D00A0B-S4	BSP000F	15	BSP B250-EV003-A02A0B-S4	BSP002Y	17
BSP B002-EV002-D01A0B-S4	BSP003K	15	BSP B250-EV003-A03A0B-S4	BSP003J	17
BSP B002-EV003-A00A0B-S4	BSP002A	17	BSP B250-EV003-D00A0B-S4	BSP0027	17
BSP B002-EV003-A01A0B-S4	BSP0045	17	BSP B250-EV003-D01A0B-S4	BSP0035	17
BSP B002-EV003-A02A0B-S4	BSP002N	17	BSP B400-EV002-A00A0B-S4	BSP0012	15
BSP B002-EV003-A03A0B-S4	BSP0049	17	BSP B400-EV002-A01A0B-S4	BSP003T	15
BSP B002-EV003-D00A0B-S4	BSP0021	17	BSP B400-EV002-A02A0B-S4	BSP001C	15
BSP B002-EV003-D01A0B-S4	BSP0041	17	BSP B400-EV002-A03A0B-S4	BSP003Z	15
BSP B005-EV002-A00A0B-S4	BSP000U	15	BSP B400-EV002-D00A0B-S4	BSP000P	15
BSP B005-EV002-A01A0B-S4	BSP003R	15	BSP B400-EV002-D01A0B-S4	BSP003M	15
BSP B005-EV002-A02A0B-S4	BSP0015	15	BSP B400-EV003-A00A0B-S4	BSP002L	17
BSP B005-EV002-A03A0B-S4	BSP003Y	15	BSP B400-EV003-A01A0B-S4	BSP0047	17
BSP B005-EV002-D00A0B-S4	BSP000H	15	BSP B400-EV003-A02A0B-S4	BSP002Z	17
BSP B005-EV002-D01A0B-S4	BSP003L	15	BSP B400-EV003-A03A0B-S4	BSP004C	17
BSP B005-EV003-A00A0B-S4	BSP002C	17	BSP B400-EV003-D00A0B-S4	BSP0028	17
BSP B005-EV003-A01A0B-S4	BSP0046	17	BSP B400-EV003-D01A0B-S4	BSP0043	17
BSP B005-EV003-A02A0B-S4	BSP002P	17	BSP B600-EV002-A00A0B-S4	BSP0013	15
BSP B005-EV003-A03A0B-S4	BSP004A	17	BSP B600-EV002-A01A0B-S4	BSP003U	15
BSP B005-EV003-D00A0B-S4	BSP0022	17	BSP B600-EV002-A02A0B-S4	BSP001E	15
BSP B005-EV003-D01A0B-S4	BSP0042	17	BSP B600-EV002-A03A0B-S4	BSP0040	15
BSP B010-EV002-A00A0B-S4	BSP000W	15	BSP B600-EV002-D00A0B-S4	BSP000R	15
BSP B010-EV002-A01A0B-S4	BSP001M	15	BSP B600-EV002-D01A0B-S4	BSP003N	15
BSP B010-EV002-A02A0B-S4	BSP0016	15	BSP B600-EV003-A00A0B-S4	BSP002M	17
BSP B010-EV002-A03A0B-S4	BSP001U	15	BSP B600-EV003-A01A0B-S4	BSP0048	17
BSP B010-EV002-D00A0B-S4	BSP000J	15	BSP B600-EV003-A02A0B-S4	BSP0030	17
BSP B010-EV002-D01A0B-S4	BSP001F	15	BSP B600-EV003-A03A0B-S4	BSP004E	17
BSP B010-EV003-A00A0B-S4	BSP002E	17	BSP B600-EV003-D00A0B-S4	BSP0029	17
BSP B010-EV003-A01A0B-S4	BSP0036	17	BSP B600-EV003-D01A0B-S4	BSP0044	17
BSP B010-EV003-A02A0B-S4	BSP002R	17	BSP V002-EV002-A00A0B-S4	BSP004J	15
BSP B010-EV003-A03A0B-S4	BSP003C	17	BSP V002-EV002-A01A0B-S4	BSP004R	15
BSP B010-EV003-D00A0B-S4	BSP0023	17	BSP V002-EV002-A02A0B-S4	BSP004L	15
BSP B010-EV003-D01A0B-S4	BSP0031	17	BSP V002-EV002-A03A0B-S4	BSP004U	15
BSP B020-EV002-A00A0B-S4	BSP000Y	15	BSP V002-EV002-D00A0B-S4	BSP004F	15
BSP B020-EV002-A01A0B-S4	BSP001N	15	BSP V002-EV002-D01A0B-S4	BSP004N	15
BSP B020-EV002-A02A0B-S4	BSP0017	15	BSP V002-EV003-A00A0B-S4	BSP0050	17
BSP B020-EV002-A03A0B-S4	BSP001W	15	BSP V002-EV003-A01A0B-S4	BSP0056	17
BSP B020-EV002-D00A0B-S4	BSP000K	15	BSP V002-EV003-A02A0B-S4	BSP0052	17
BSP B020-EV002-D01A0B-S4	BSP001H	15	BSP V002-EV003-A03A0B-S4	BSP0058	17
BSP B020-EV003-A00A0B-S4	BSP002F	17	BSP V002-EV003-D00A0B-S4	BSP004Y	17
BSP B020-EV003-A01A0B-S4	BSP0037	17	BSP V002-EV003-D01A0B-S4	BSP0054	17
BSP B020-EV003-A02A0B-S4	BSP002T	17	BSP V010-EV002-A00A0B-S4	BSP004K	15
BSP B020-EV003-A03A0B-S4	BSP003E	17	BSP V010-EV002-A01A0B-S4	BSP004T	15
BSP B020-EV003-D00A0B-S4	BSP0024	17	BSP V010-EV002-A02A0B-S4	BSP004M	15
BSP B020-EV003-D01A0B-S4	BSP0032	17	BSP V010-EV002-A03A0B-S4	BSP004W	15
BSP B050-EV002-A00A0B-S4	BSP000Z	15	BSP V010-EV002-D00A0B-S4	BSP004H	15
BSP B050-EV002-A01A0B-S4	BSP001P	15	BSP V010-EV002-D01A0B-S4	BSP004P	15
BSP B050-EV002-A02A0B-S4	BSP0018	15	BSP V010-EV003-A00A0B-S4	BSP0051	17
BSP B050-EV002-A03A0B-S4	BSP001Y	15	BSP V010-EV003-A01A0B-S4	BSP0057	17
BSP B050-EV002-D00A0B-S4	BSP000L	15	BSP V010-EV003-A02A0B-S4	BSP0053	17
BSP B050-EV002-D01A0B-S4	BSP001J	15	BSP V010-EV003-A03A0B-S4	BSP0059	17
BSP B050-EV003-A00A0B-S4	BSP002H	17	BSP V010-EV003-D00A0B-S4	BSP004Z	17
BSP B050-EV003-A01A0B-S4	BSP0038	17	BSP V010-EV003-D01A0B-S4	BSP0055	17
BSP B050-EV003-A02A0B-S4	BSP002U	17			
BSP B050-EV003-A03A0B-S4	BSP003F	17			
BSP B050-EV003-D00A0B-S4	BSP0025	17			



Sorted by ordering code

Ordering code	Part number	Page	Ordering code	Part number	Page
BAM01KP	BAM AD-SP-008-1G4/1G4-4	18	BSP002M	BSP B600-EV003-A00A0B-S4	17
BAM01KR	BAM AD-SP-008-1G4/1G4-4-EN837	18	BSP002N	BSP B002-EV003-A02A0B-S4	17
BAM01KT	BAM AD-SP-008-1G4/1N4-4	18	BSP002P	BSP B005-EV003-A02A0B-S4	17
BCC02FE	BKS-S260-3-02	19	BSP002R	BSP B010-EV003-A02A0B-S4	17
BCC02FF	BKS-S260-3-05	19	BSP002T	BSP B020-EV003-A02A0B-S4	17
BCC032F	BCC M415-0000-1A-003-PX0434-020	19	BSP002U	BSP B050-EV003-A02A0B-S4	17
BCC032H	BCC M415-0000-1A-003-PX0434-050	19	BSP002W	BSP B100-EV003-A02A0B-S4	17
BCC032J	BCC M415-0000-1A-003-PX0434-100	19	BSP002Y	BSP B250-EV003-A02A0B-S4	17
BCC032Y	BCC M425-0000-1A-003-PX0434-020	19	BSP002Z	BSP B400-EV003-A03A0B-S4	17
BCC032Z	BCC M425-0000-1A-003-PX0434-050	19	BSP0030	BSP B600-EV003-A02A0B-S4	17
BCC0330	BCC M425-0000-1A-003-PX0434-100	19	BSP0031	BSP B010-EV003-D01A0B-S4	17
BCC0367	BCC M415-0000-1A-003-VX8434-020	19	BSP0032	BSP B020-EV003-D01A0B-S4	17
BCC0368	BCC M415-0000-1A-003-VX8434-050	19	BSP0033	BSP B050-EV003-D01A0B-S4	17
BCC0369	BCC M415-0000-1A-003-VX8434-100	19	BSP0034	BSP B100-EV003-D01A0B-S4	17
BCC036N	BCC M425-0000-1A-003-VX8434-020	19	BSP0035	BSP B250-EV003-D01A0B-S4	17
BCC036P	BCC M425-0000-1A-003-VX8434-050	19	BSP0036	BSP B010-EV003-A01A0B-S4	17
BCC036R	BCC M425-0000-1A-003-VX8434-100	19	BSP0037	BSP B020-EV003-A01A0B-S4	17
BSP000F	BSP B002-EV002-D00A0B-S4	15	BSP0038	BSP B050-EV003-A01A0B-S4	17
BSP000H	BSP B005-EV002-D00A0B-S4	15	BSP0039	BSP B100-EV003-A01A0B-S4	17
BSP000J	BSP B010-EV002-D00A0B-S4	15	BSP003A	BSP B250-EV003-A01A0B-S4	17
BSP000K	BSP B020-EV002-D00A0B-S4	15	BSP003C	BSP B010-EV003-A03A0B-S4	17
BSP000L	BSP B050-EV002-D00A0B-S4	15	BSP003E	BSP B020-EV003-A03A0B-S4	17
BSP000M	BSP B100-EV002-D00A0B-S4	15	BSP003F	BSP B050-EV003-A03A0B-S4	17
BSP000N	BSP B250-EV002-D00A0B-S4	15	BSP003H	BSP B100-EV003-A03A0B-S4	17
BSP000P	BSP B400-EV002-D00A0B-S4	15	BSP003J	BSP B250-EV003-A03A0B-S4	17
BSP000R	BSP B600-EV002-D00A0B-S4	15	BSP003K	BSP B002-EV002-D01A0B-S4	15
BSP000T	BSP B002-EV002-A00A0B-S4	15	BSP003L	BSP B005-EV002-D01A0B-S4	15
BSP000U	BSP B005-EV002-A00A0B-S4	15	BSP003M	BSP B400-EV002-D01A0B-S4	15
BSP000W	BSP B010-EV002-A00A0B-S4	15	BSP003N	BSP B600-EV002-D01A0B-S4	15
BSP000Y	BSP B020-EV002-A00A0B-S4	15	BSP003P	BSP B002-EV002-A01A0B-S4	15
BSP000Z	BSP B050-EV002-A00A0B-S4	15	BSP003R	BSP B005-EV002-A01A0B-S4	15
BSP0010	BSP B100-EV002-A00A0B-S4	15	BSP003T	BSP B400-EV002-A01A0B-S4	15
BSP0011	BSP B250-EV002-A00A0B-S4	15	BSP003U	BSP B600-EV002-A01A0B-S4	15
BSP0012	BSP B400-EV002-A00A0B-S4	15	BSP003W	BSP B002-EV002-A03A0B-S4	15
BSP0013	BSP B600-EV002-A00A0B-S4	15	BSP003Y	BSP B005-EV002-A03A0B-S4	15
BSP0014	BSP B002-EV002-A02A0B-S4	15	BSP003Z	BSP B400-EV002-A03A0B-S4	15
BSP0015	BSP B005-EV002-A02A0B-S4	15	BSP0040	BSP B600-EV002-A03A0B-S4	15
BSP0016	BSP B010-EV002-A02A0B-S4	15	BSP0041	BSP B002-EV003-D01A0B-S4	17
BSP0017	BSP B020-EV002-A02A0B-S4	15	BSP0042	BSP B005-EV003-D01A0B-S4	17
BSP0018	BSP B050-EV002-A02A0B-S4	15	BSP0043	BSP B400-EV003-D01A0B-S4	17
BSP0019	BSP B100-EV002-A02A0B-S4	15	BSP0044	BSP B600-EV003-D01A0B-S4	17
BSP001A	BSP B250-EV002-A02A0B-S4	15	BSP0045	BSP B002-EV003-A01A0B-S4	17
BSP001C	BSP B400-EV002-A02A0B-S4	15	BSP0046	BSP B005-EV003-A01A0B-S4	17
BSP001E	BSP B600-EV002-A02A0B-S4	15	BSP0047	BSP B400-EV003-A01A0B-S4	17
BSP001F	BSP B010-EV002-D01A0B-S4	15	BSP0048	BSP B600-EV003-A01A0B-S4	17
BSP001H	BSP B020-EV002-D01A0B-S4	15	BSP0049	BSP B002-EV003-A03A0B-S4	17
BSP001J	BSP B050-EV002-D01A0B-S4	15	BSP004A	BSP B005-EV003-A03A0B-S4	17
BSP001K	BSP B100-EV002-D01A0B-S4	15	BSP004C	BSP B400-EV003-A03A0B-S4	17
BSP001L	BSP B250-EV002-D01A0B-S4	15	BSP004E	BSP B600-EV003-A03A0B-S4	17
BSP001M	BSP B010-EV002-A01A0B-S4	15	BSP004F	BSP V002-EV002-D00A0B-S4	15
BSP001N	BSP B020-EV002-A01A0B-S4	15	BSP004H	BSP V010-EV002-D00A0B-S4	15
BSP001P	BSP B050-EV002-A01A0B-S4	15	BSP004J	BSP V002-EV002-A00A0B-S4	15
BSP001R	BSP B100-EV002-A01A0B-S4	15	BSP004K	BSP V010-EV002-A00A0B-S4	15
BSP001T	BSP B250-EV002-A01A0B-S4	15	BSP004L	BSP V002-EV002-A02A0B-S4	15
BSP001U	BSP B010-EV002-A03A0B-S4	15	BSP004M	BSP V010-EV002-A02A0B-S4	15
BSP001W	BSP B020-EV002-A03A0B-S4	15	BSP004N	BSP V002-EV002-D01A0B-S4	15
BSP001Y	BSP B050-EV002-A03A0B-S4	15	BSP004P	BSP V010-EV002-D01A0B-S4	15
BSP001Z	BSP B100-EV002-A03A0B-S4	15	BSP004R	BSP V002-EV002-A01A0B-S4	15
BSP0020	BSP B250-EV002-A03A0B-S4	15	BSP004T	BSP V010-EV002-A01A0B-S4	15
BSP0021	BSP B002-EV003-D00A0B-S4	17	BSP004U	BSP V002-EV002-A03A0B-S4	15
BSP0022	BSP B005-EV003-D00A0B-S4	17	BSP004W	BSP V010-EV002-A03A0B-S4	15
BSP0023	BSP B010-EV003-D00A0B-S4	17	BSP004Y	BSP V002-EV003-D00A0B-S4	17
BSP0024	BSP B020-EV003-D00A0B-S4	17	BSP004Z	BSP V010-EV003-D00A0B-S4	17
BSP0025	BSP B050-EV003-D00A0B-S4	17	BSP0050	BSP V002-EV003-A00A0B-S4	17
BSP0026	BSP B100-EV003-D00A0B-S4	17	BSP0051	BSP V010-EV003-A00A0B-S4	17
BSP0027	BSP B250-EV003-D00A0B-S4	17	BSP0052	BSP V002-EV003-A02A0B-S4	17
BSP0028	BSP B400-EV003-D00A0B-S4	17	BSP0053	BSP V010-EV003-A02A0B-S4	17
BSP0029	BSP B600-EV003-D00A0B-S4	17	BSP0054	BSP V002-EV003-D01A0B-S4	17
BSP002A	BSP B002-EV003-A00A0B-S4	17	BSP0055	BSP V010-EV003-D01A0B-S4	17
BSP002C	BSP B005-EV003-A00A0B-S4	17	BSP0056	BSP V002-EV003-A01A0B-S4	17
BSP002E	BSP B010-EV003-A00A0B-S4	17	BSP0057	BSP V010-EV003-A01A0B-S4	17
BSP002F	BSP B020-EV003-A00A0B-S4	17	BSP0058	BSP V002-EV003-A03A0B-S4	17
BSP002H	BSP B050-EV003-A00A0B-S4	17	BSP0059	BSP V010-EV003-A03A0B-S4	17
BSP002J	BSP B100-EV003-A00A0B-S4	17			
BSP002K	BSP B250-EV003-A00A0B-S4	17			
BSP002L	BSP B400-EV003-A00A0B-S4	17			

Headquarters

Germany

Balluff GmbH
Schurwaldstrasse 9
73765 Neuhausen a.d.F.
Phone: +49 7158 173-0
Fax +49 7158 5010
balluff@balluff.com

Subsidiaries and Representatives

Argentina

Nortécnica S.R.L.
103 – Heredia 638
B1672BKD
Villa Lynch – San Martin
Pcia. de Buenos Aires
Phone +54 11 47573129
Fax +54 11 47571088
info@nortecnica.com.ar

Australia

Balluff-Leuze Pty. Ltd.
12 Burton Court
Bayswater VIC 3153
Phone +61 397 204100
Fax +61 397 382677
sales@balluff.com.au

Austria

Balluff GmbH
Industriestraße B16
2345 Brunn am Gebirge
Tel. +43 2236 32521-0
Fax +43 2236 32521-46
sensor@balluff.at

Belarus

Automaticcentre OOO.
Nezavisimosti Av. 185,
Block 19, Office 3
220125 Minsk
Phone +375 17 2181713
Fax +375 17 2181798
balluff@nsys.by

Belgium

Balluff bvba
Researchpark Haasrode 1820
Interleuvenlaan 62,
3001 Leuven
Phone +32 16 397800
Fax +32 16 397809
info.be@balluff.be

Brazil

Balluff Controles
Elétricos Ltda.
Rua Francisco Foga, 25
Distrito Industrial
CEP 13280.000
Vinhedo – Sao Paulo
Phone +55 19 38769999
Fax +55 19 38769990
balluff@balluff.com.br

Bulgaria

BPS AG
41, Nedelcho Bonchev St.
1528 Sofia
Phone +359 2 9609875
Fax +359 2 9609896
bps@bps.bg

Canada

Balluff Canada Inc.
2840 Argentinia Road, Unit 2
Mississauga, Ontario L5N 8G4
Phone 905 816-1494
Toll-free 1-8 00-927-9654
Fax 905 816-1411
balluff.canada@balluff.ca

Chile

Balluff Controles
Elétricos Ltda.,
Brazil

China

Balluff (Shanghai) Trading Co. Ltd.
Room 1006, Pujian Road 145,
Shanghai 200127
Phone +86 21 5089 9970
Fax +86 21 5089 9975
info@balluff.com.cn

Columbia

Balluff Controles
Elétricos Ltda.,
Brazil

Croatia

HSTEC d.d.
Zagrebicka 100
23000 Zadar
Phone +385 23 205-405
Fax +385 23 205-406
info@hstec.hr

Czech Republic

Balluff CZ, s.r.o
Pelušková 1400
198 00 Praha 9 – Kyje
Phone +420 281 000 666
Fax +420 281 940066
obchod@balluff.cz

Denmark

Balluff ApS
Åbogade 15
8200 Århus N
Phone +45 70 234929
Fax +45 70 234930
info.dk@balluff.dk

Egypt

EGEC
24 St., 302 Taksym El Kodah-smouha,
First Floor, Department 1
Alexandria
Phone +20 3 4299771
Fax +20 3 4261773
info@egecgroup.com

Finland

Murri Oy
Koukkukatu 1
15700 Lahti
Phone +358 3 8824000
Fax +358 3 8824040
myynti@murri.fi

France

Balluff SAS
ZI Nord de Torcy-Bat 3
Rue des Tanneurs – BP 48
77201 Marne La Vallée Cedex 1
Phone +33 1 64111990
Fax +33 1 64111991
info.fr@balluff.fr

Greece

S. NAZOS S.A.
10 KLM Thessalonikis-Kilkis
P.O. Box 57008
Thessaloniki
Phone +30 2310 462120
Fax +30 2310 474079
parasxos@nazos.gr

Hong Kong

Sensortech Company
No. 43, 18th Street
Hong Lok Yuen,
Tai Po, NT
Phone +852 26510188
Fax +852 26510388
sensortech@netvigator.com

Hungary

Balluff Elektronika Kft.
Pápai út. 55.
8200 Veszprém
Phone +36 88 421808
Fax +36 88 423439
saleshu@balluff.hu

Iceland

Smith & Norland
Nóatúni 4
105 Reykjavik
Phone +354 520 3000
Fax +354 520 3011
olaf@sminor.is

India

Balluff India
405 Raikar Chambers
Deonar Village Road,
Govandi, Mumbai 400088
Phone +91 22 25568097
Fax +91 22 25560871
olaf@balluff.co.in

Indonesia

PT. Multiguna Cemerlang
Bumi Serpong Damai Sektor XI
Multipurpose Industrial Building
Block H 3-31
Serpong Tangerang
15314 Banten
Phone +62 21 75875555
Fax +62 21 75875678
sales_bsd@multigunacemerlang.com

Israel

Ancitech Ltd.
19, Hamashbir St.
Industrial Zone Holon
58853 Holon
Phone +972 3 5568351
Fax +972 3 5569278
nissim@ancitech.com

Italy

Balluff Automation S.R.L.
Via Morandi 4
10095 Grugliasco, Torino
Phone +39 11 3150711
Fax +39 11 3170140
info.italy@balluff.it

Japan

Balluff Co., Ltd.
Ishikawa Bldg. 2nd Fl.
1-5-5 Yanagibashi, Taito-Ku
Tokyo 111-0052
Tel. +81 03 5833-5440
Fax +81 03 5833-5441
info.jp@balluff.jp

Kazakhstan

elcos electric control systems
2A, Molodezhniy Str. 3D
Block O., Offices 318-319
050061 Almaty
Phone +7 727 3340536
Fax +7 727 3340539
info@elcos.kz

Lithuania

UAB Interautomatika
Kęstučio 47
08127 Vilnius
Phone +370 5 2607810
Fax +370 5 2411464
andrius@interautomatika.lt

Malaysia

Profacto Solution & Services Sdn. Bhd.
No. 23-1 Jalan Bandar Empat Balas
Pusat Bandar Puchong,
47100 Puchong, Selangor
Phone +60 35882 2684
Fax +60 35882 2685
ckkkkyong@streamyx.com

Team Automation Systems (M) Sdn. Bhd.
No. 94-B, Jalan Raja Uda
Butterworth, Penang
Phone +60 4 3102888
Fax +60 4 3102889
sales-pg@teamtas.com.my

Mexico

Balluff de México S.A. de C.V.
Prol. Av. Luis M. Vega #109
Col. Ampliación Cimatario
C.P. 76030
Queretaro, Qro.
Phone +52 442 2124882
Fax +52 442 2140536
balluff.mexico@balluff.com

Netherlands

Balluff B.V.
Kempenlandstraat 11H
5262 GK Vught
Phone +31 73 6579702
Fax +31 73 6579786
info.nl@balluff.nl

New Zealand

Balluff-Leuze Pty. Ltd.,
Australia

Norway

Primatec as
Lillesandsveien 44
4877 Grimstad
Phone +47 37 258700
Fax +47 37 258710
post@primatec.no

Philippines

Technorand Sales Corporation
803 Wilshire Annapolis Plaza,
No. 11 Annapolis Street,
San Juan, Metro Manila 1500
Phone +63 2 7245006
Fax +63 2 7245010
technorand@gmail.com

Poland

Balluff Sp. z o.o.
Ul. Muchoborska 16
54-424 Wrocław
Phone +48 71 3384929
Fax +48 71 3384930
balluff@balluff.pl

Portugal

LA2P Lda.
Rua Teófilo Braga, 156 A
Escrit. F – Edifício S. Domingos
Cabeco Do Mouro
2785-122 S. Domingos De Rana
Phone +351 21 4447070
Fax +351 21 4447075
la2p@la2p.pt

Romania

East Electric s.r.l.
256 Basarabia Blvd.
030352 Bucuresti
Phone +40 31 4016301
Fax +40 31 4016302
office@eastelectric.ro

Russia

Balluff OOO
M. Kaluzhskaja Street 15
Building 17, Office 500
119071 Moscow
Phone +7 495 78071-94
Fax +7 495 78071-97
balluff@balluff.ru

Serbia

ENEL d.o.o.
Ul. Vasilja Pavlovica 10
14000 Valjevo
Phone +381 14 291161
Fax +381 14 244641
enelvaljevo@gmail.com

Singapore

Balluff Asia Pte. Ltd.
BLK 1004 Toa Payoh
Ind. Park
Lorong 8, #03-1489
Singapore 319076
Phone +65 62524384
Fax +65 62529060
balluff@balluff.com.sg

Slovakia

Balluff Slovakia s.r.o.
Blagoevova 9
85104 Bratislava
Phone +421 2 67200062
Fax +421 2 67200060
info@balluff.sk

Slovenia

Senzorji SB d.o.o.,
Proizvodnja,
trgovina in storitve d.o.o.
Livadna ulica 1
2204 Miklavž na Dravskem polju
Phone +386 2 6290300
Fax +386 2 6290302
senzorji.sb@siol.net

South Africa

PAL Distributers CC
291A Pine Avenue, Ferndale
Randburg, Gauteng
Phone +27 11 7814381
Fax +27 11 7818166
pal@polka.co.za

South Korea

Mahani Electric Co. Ltd.
792-7 Yeoksam-Dong
Kangnam-Gu, Seoul
Post code: 135-080
Phone +82 2 21943300
Fax +82 2 21943397
yskim@hanmec.co.kr

Spain

Balluff S.L.
Edificio Forum SCV
Planta 5°, Oficina 4°
Carretera Sant Cugat a Rubi
Km01, 40-50
08190 Sant Cugat del Vallés
Barcelona
Phone +34 93 5441313
Fax +34 93 5441312
info.es@balluff.es

Sweden

Balluff AB
Gamlestadsvägen 2, B19
41502 Göteborg
Phone +46 31 3408630
Fax +46 31 3409431
info.se@balluff.se

Switzerland

Balluff Sensortechnik AG
Riedstrasse 6
8953 Dietikon
Phone +41 43 3223240
Fax +41 43 3223241
sensortechnik@balluff.ch

Taiwan

Canaan Electric Corp.
6F-5, No. 63 Sec. 2
Chang An East Road
10455 Taipei
Phone +886 22 5082331
Fax +886 22 5084744
sales@canaan-elec.com.tw

Thailand

Compomax Co. Ltd.
16 Soi Ekamai 4,
Sukhumvit 63 Rd.
Prakanongnua, Vadhana,
Bangkok 10110
Phone +66 2 7269595
Fax +66 2 7269800
info@compomax.co.th

Turkey

Balluff Sensor Otomasyon
Sanayi Ve Ticaret Ltd. Sti.
Perpa Ticaret Is Merkezi
A Blok, Kat 1-2-3
No: 0013-0014
34381 Okmeydani/Istanbul
Phone +90 212 3200411
Fax +90 212 3200416
balluff@balluff.com.tr

Ukraine

Micronlogistik Ltd.
Ul. Promyischlennaya Street 37
65031 Odessa
Phone +380 48 7781278
Fax +380 48 2358760
info@balluff-ua.com

United Arab Emirates

Multiline Technical Co.
TCA, behind ADCB Bank
46530 Abu Dhabi
Phone +971 2 6457760
Fax +971 2 6459761
multiline@emirates.net.ae

United Kingdom and Ireland

Balluff Ltd.
4 Oakwater Avenue
Cheadle Royal Business Park
Cheadle, Cheshire SK8 3SR
Phone +44 161 282-4700
Fax +44 161 282-4701
sales@balluff.co.uk

USA

Balluff Inc.
8125 Holton Drive
Florence, KY 41042-0937
Phone +1 859 727-2200,
Toll-free 1-800-543-8390
Fax +1 859 727-4823
balluff@balluff.com

Venezuela

Balluff Controles
Eléctricos Ltda.,
Brazil





Object Detection

Inductive sensors BES, cylinder sensors BMF, magnetic field sensors BMF, capacitive sensors BCS for object detection, ultrasonic sensors BUS for object detection, photoelectric sensors BOS, fiber optic devices BFB, fiber optics BFO, angle sensors BWL, through-beam fork sensors BGL, optical window sensors BOW, light grids BLG, contrast sensors BKT, luminescence sensors BLT, color sensors BFS, mechanical and inductive single and multiple position switches BNS

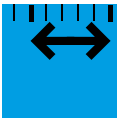

Linear Position Sensing

Micropulse® transducers BTL, magnetic linear encoder system BML, incremental encoders BDG, absolute encoders BRG, inductive displacement system BIW, inductive positioning system BIP, inductive distance sensors BAW, magnetoinductive distance sensors BIL, capacitive distance sensors BCW, photoelectric distance sensors BOD, ultrasonic sensors BUS for analog distance measurement



Fluid Sensors

Pressure sensors BSP, capacitive sensors BCS for level detection

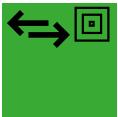

Industrial Identification

Industrial RFID systems BIS, vision sensors BVS

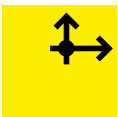

Industrial Networking and Connectivity

Connectors and connection cables BCC, valve connectors BCC, passive splitter boxes BPI, active splitter boxes BNI, IO-Link, bus systems (Profibus, Profinet, CC-Link, DeviceNet, EtherNet), inductive couplers BIC, wireless systems BWT, power supplies BAE, electrical devices BAE



Accessories

Brackets and mountings, assembly system BMS

Balluff GmbH
Schurwaldstrasse 9
73765 Neuhausen a.d.F.
Germany
Phone +49 7158 173-0
Fax +49 7158 5010
balluff@balluff.com

