

## Lighted Pushbutton Switch



## A3A

### Compact Switch Unit Allows Signal and Power Switching with the Same Model

- Compact, high-capacity push-button switch that has contacts with a 3-mm gap and is ideal as a power switch.
- Capable of switching within the range of 1 mA, 5 VDC to 6 A, 125 VAC.
- Requires only 14.5 mm behind the panel.
- Options include the following:
  - Round or square
  - Momentary or alternating
  - Surface illumination or non-lighted

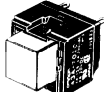
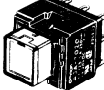

### Ordering Information

#### SPST-NO

Appearance	Terminal	Action	Illumination	Model	Color
<b>Square</b> <b>A3AA-9j j 1-00j</b>  <b>A3AA-9j j 1-00Ej</b> 	Solder	Momentary	Non-lighted	A3AA-90K1-00j	R (red)
			Surface illumination	A3AA-90K1-00Ej	Y (yellow)
		Alternating	Non-lighted	A3AA-90L1-00j	G (green)
			Surface illumination	A3AA-90L1-00Ej	L (light gray) (see note)
	PCB	Momentary	Non-lighted	A3AA-91K1-00j	A (Blue) (see note)
			Surface illumination	A3AA-91K1-00Ej	B (black) (see note)
		Alternating	Non-lighted	A3AA-91L1-00j	D (dark gray) (see note)
			Surface illumination	A3AA-91L1-00Ej	H (gray) (see note)
<b>Round</b> <b>A3AT-9j j 1-00j</b>  <b>A3AT-9j j 1-00Ej</b> 	Solder	Momentary	Non-lighted	A3AT-90K1-00j	
			Surface illumination	A3AT-90K1-00Ej	
		Alternating	Non-lighted	A3AT-90L1-00j	
			Surface illumination	A3AT-90L1-00Ej	
	PCB	Momentary	Non-lighted	A3AT-91K1-00j	
			Surface illumination	A3AT-91K1-00Ej	
		Alternating	Non-lighted	A3AT-91L1-00j	
			Surface illumination	A3AT-91L1-00Ej	

**Note:** The above models each have a SPST-NO contact that can switch 6 A at 125 VAC, 2 A at 250 VAC, and 4 A at 30 VDC. When ordering any of the above models, replace j of the model number with a code to indicate the pushbutton color of the model (i.e., replace j with R, Y, G, L, A, B, D, H, and L). The pushbutton of an A3A does not illuminate if the color of the pushbutton is dark gray, gray, light gray, blue, or black.

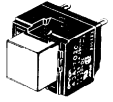
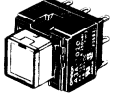
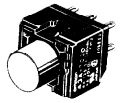
## SPDT

Appearance	Terminal	Action	Illumination	Model	Color
<b>Square</b> <b>A3AA-9j j 1-00j</b>  <b>A3AA-9j j 1-00Ej</b> 	Solder	Momentary	Non-lighted	A3AA-90A1-00j	R (red) Y (yellow) G (green) L (light gray) (see note) A (blue) (see note) B (black) (see note) D (dark gray) (see note) H (gray) (see note)
			Surface illumination	A3AA-90A1-00Ej	
		Alternating	Non-lighted	A3AA-90B1-00j	
			Surface illumination	A3AA-90B1-00Ej	
	PCB	Momentary	Non-lighted	A3AA-91A1-00j	
			Surface illumination	A3AA-91A1-00Ej	
Alternating		Non-lighted	A3AA-91B1-00j		
		Surface illumination	A3AA-91B1-00Ej		
<b>Round</b> <b>A3AT-9j j 1-00j</b>  <b>A3AT-9j j 1-00Ej</b> 	Solder	Momentary	Non-lighted	A3AT-90A1-00j	
			Surface illumination	A3AT-90A1-00Ej	
		Alternating	Non-lighted	A3AT-90B1-00j	
			Surface illumination	A3AT-90B1-00Ej	
	PCB	Momentary	Non-lighted	A3AT-91A1-00j	
			Surface illumination	A3AT-91A1-00Ej	
		Alternating	Non-lighted	A3AT-91B1-00j	
			Surface illumination	A3AT-91B1-00Ej	

**Note:** The above models each have a SPDT contact that can switch 3 A at 125 VAC and 2 A at 30 VDC. When ordering any of the above models, replace j of the model number with a code to indicate the pushbutton color of the model (i.e., replace j with R, Y, G, L, A, B, D, H, and L). The pushbutton of an A3A does not illuminate if the color of the pushbutton is dark gray, gray, light gray, blue, or black.

## Model Number Legend

**A3A**  **j**  **-**  **9j**  **j**  **1-**  **j**  **j**  

1    2   3   4   5

## 1. Shape

A: Square  
T: Round

## 2. Terminal

0: Solder  
1: PCB

## 3. Switch

6 A at 125 VAC, 2 A at 250 VAC, 4 A at 30 VDC  
A: Momentary (SPDT)  
B: Alternating (SPDT)  
K: Momentary (SPST-NO)  
L: Alternating (SPST-NO)

## 4. Illumination

00: Non-lighted  
00E: Surface illumination

## 5. Color

**Switch (Non-lighted Models)**

L: Light gray  
R: Red  
Y: Yellow  
G: Green  
A: Blue  
B: Black  
D: Dark gray  
H: Gray





**LED (Surface Illumination Models)**

R: Red  
Y: Yellow  
G: Green

## ■ Accessories (Order Separately)

### Flange

Select according to panel color.

Name	Shape	Classification		Model
Flange	Square, 12.7 x 12.7 	Flange alone	Black	A3A-241
			Light gray	A3A-242
	Round, 12.7 dia. 	Flange alone	Black	A3A-251
			Light gray	A3A-252
		Leaf spring		A3A-200
	Square, 12.7 x 12.7 	Flange and leaf spring (one each)	Black	A3A-211
			Light gray	A3A-212
	Round, 12.7 dia. 	Flange and leaf spring (one each)	Black	A3A-221
			Light gray	A3A-222

**Note:** An A3A with solder terminals is provided with a round or square black flange and flat spring for the switching mechanism of the A3A. A round black flange is provided with each A3A having solder terminals and a round pushbutton. A square black flange is provided with each A3A having solder terminals and a square pushbutton.

## Specifications

### ■ Contact Ratings

Type	Contact form	Resistive load	
High capacity	SPST-NO	6 A at 125 VAC 2 A at 250 VAC	4 A at 30 VDC

**Note:** Minimum allowable load: 5 VDC 1 mA (Resistive)

### ■ LED Ratings

Item		Surface illumination		
		Red	Yellow	Green
Forward voltage $V_F$	Standard value	2.1 V	(2.2 V)	2.2 V
	Maximum value	2.8 V		
Forward current $I_F$	Standard value	15 mA		
	Maximum value	25 mA		
Permissible loss PD	Absolute max. value	70 mW		
Reverse voltage $V_R$	Absolute max. value	3 V		

**Note:** The above built-in LEDs do not have a resistor. Connect to each of the above built-in LEDs a resistor that satisfies the above conditions.

## ■ Characteristics

<b>Operating frequency</b>	Mechanical: Momentary action: 120 operations/min max. Alternating action: 60 operations/min max. (see note 1) Electrical: 20 operations/min max.
<b>Insulation resistance</b>	100 M $\Omega$ min. (at 500 VDC)
<b>Contact resistance</b>	100 m $\Omega$ max. (initial value) for high-capacity
<b>Dielectric strength</b>	600 VAC, 50/60 Hz for 1 min between terminals of same polarity 2,000 VAC, 50/60 Hz for 1 min between terminals of different polarity 2,000 VAC, 50/60 Hz for 1 min between each terminal and ground 600 VAC, 50/60 Hz for 1 min between LED terminal (see note 2)
<b>Vibration resistance</b>	Malfunction: 10 to 55 Hz, 1.5-mm double amplitude
<b>Shock resistance</b>	Destruction: 500 m/s <sup>2</sup> (approx. 50G) Malfunction: 150 m/s <sup>2</sup> (approx. 15G)
<b>Life expectancy</b>	Mechanical: Momentary action: 1,000,000 operations min. Alternating action: 50,000 operations min. Electrical: 50,000 operations min.
<b>Ambient temperature</b>	Operating: -10°C to 55°C (with no icing) Storage: -25°C to 65°C
<b>Ambient humidity</b>	Operating: 35% to 85%
<b>Weight</b>	Approx. 3.2 g

**Note:** 1. A setting and resetting is regarded as one operation.

2. A dielectric strength of 600 VAC at 50 or 60 Hz for one minute is ensured for the A3A without a built-in LED.

3. An A3A alternating-operation model and an A3A with standard ratings have an electrical life of 100,000 times minimum. An A3A with a 10-mA resistive load at 6 VDC has an electrical life of 1,000,000 times.

## ■ Approved Standards

UL (File No. E41515)/CSA (File No. LR45258)

6 A at 125 VAC, 2 A at 250 VAC, 4 A at 30 VDC

## ■ Operating Characteristics

<b>OF max.</b>	250 gf (2.45 N)
<b>RF min.</b>	15 gf (0.15 N)
<b>TT</b>	Approx. 2 mm
<b>PT max.</b>	1.5 mm
<b>LTA min. (see note)</b>	0.5 mm

**Note:** The above lock stroke figure applies to the A3A Alternating Operation model only.

Type	Contact form	Resistive load	
High capacity	SPST-NO	6 A at 125 VAC 2 A at 250 VAC	4A at 30 VDC
General purpose	SPDT	3 A at 125 VAC	2 A at 30 VAC

# Nomenclature

## Pushbutton Unit

### Pushbutton

Square (A3AA)    Round (A3AT)



Diffusion sheet (milky white)

Flange

Leaf spring

Illumination

Color

**Non-lighted Model**

Red, yellow, light gray, gray, dark gray, green blue, black

**Surface Illumination Model**

Red, yellow, green

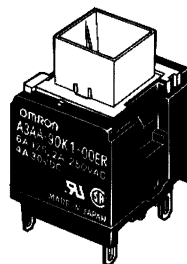

## Switch Unit

### Ratings (Standard load)

- 6 A at 125 VAC
- 2 A at 250 VAC
- 4 A at 30 VDC
- Minimum applicable load:
- 1 mA at 5 VDC (resistive load)

### Terminals

- Solder terminal
- PCB terminal

## Contact Type

Type	Contact form	Contact type
Double-break type	SPST-NO	
Double-throw type	SPDT	

- Note:**
1. The above is for the A3AA.
  2. An A3A with solder terminals is provided with a black flange and flat spring for the switching mechanism, however an A3A with PCB terminals is not provided with them. If a black flange and flat spring are required for an A3A with PCB terminals, order them from your OMRON representative.

# Dimensions

- Note:** 1. All units are in millimeters unless otherwise indicated.  
 2. The illustrations below show switches with solder terminals, without a flange or leaf spring.

## Non-lighted Model

### Square Pushbutton

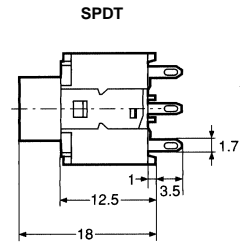
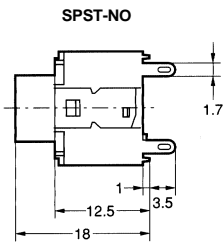
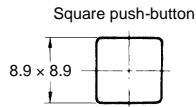
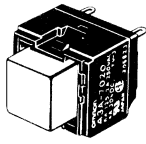

### Round Pushbutton

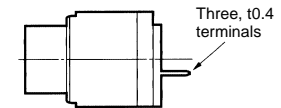
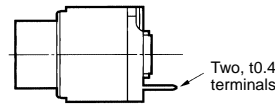
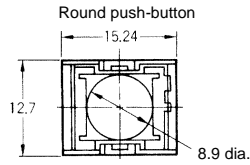
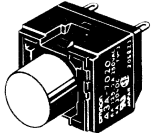

## Surface Illumination Model

### Square Pushbutton

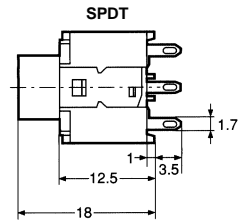
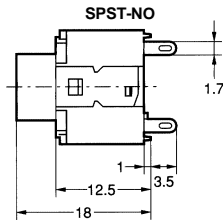
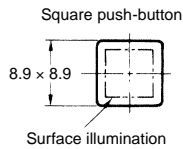
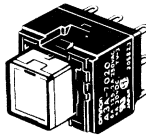

### Round Pushbutton

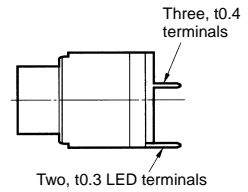
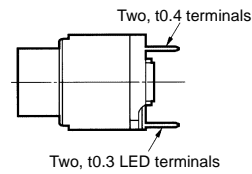
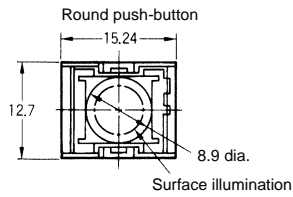
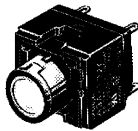

## Accessories (Order Separately)

**Note:** Unless otherwise specified, a tolerance of  $\pm 0.4$  mm applies to all dimensions.

### A3A-200 Leaf Spring

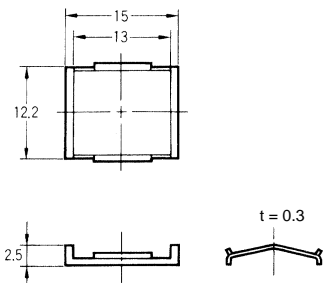

### A3A-24j Flange (Square)

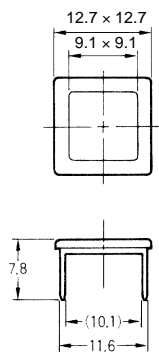

### A3A-25j Flange (Round)

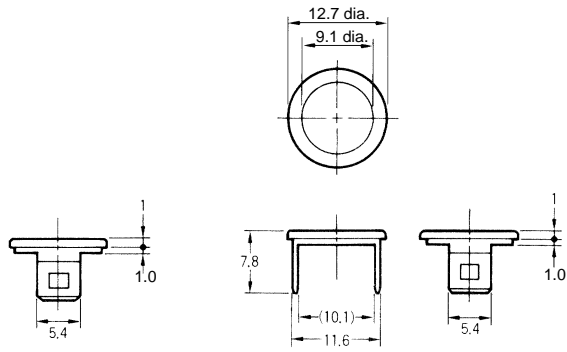

Panel Cutouts

Square Pushbutton

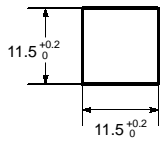

Round Pushbutton

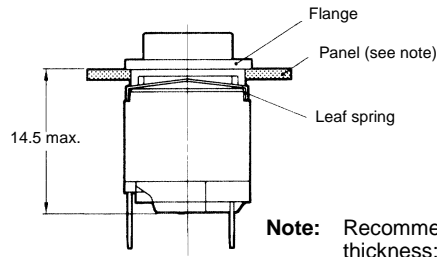
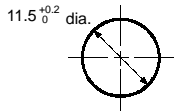

**Note:** Recommended panel thickness: 1 to 1.6 mm

For Side-by-side Mounting

Mounting	Square pushbutton	Round pushbutton
Horizontal multiple mounting	<p>15.3 min.</p> <p>11.5<sup>+0.2</sup><sub>0</sub></p> <p>3.8 min</p> <p>11.5<sup>+0.2</sup><sub>0</sub></p>	<p>11.5<sup>+0.2</sup><sub>0</sub> dia.</p> <p>15.3 min.</p>
Vertical multiple mounting	<p>11.5<sup>+0.2</sup><sub>0</sub></p> <p>12.7(n-1) + 11.5<sup>+0.3</sup><sub>0</sub></p>	<p>11.5<sup>+0.2</sup><sub>0</sub> dia.</p> <p>12.7 min.</p>

■ Terminals

	Solder terminal	PCB terminal
SPST-NO	<p><b>Non-lighted Models</b></p> <p><b>Lighted Models</b></p> <p><b>Terminal Arrangement (Bottom View)</b></p>	<p><b>Non-lighted Models</b></p> <p><b>Lighted Models</b></p> <p><b>Terminal Arrangement (Bottom View)</b></p> <p><b>PCB Dimensions (Bottom View)</b></p>
SPDT	<p><b>Non-lighted Models</b></p> <p><b>Lighted Models</b></p> <p><b>Terminal Arrangement (Bottom View)</b></p>	<p><b>Non-lighted Models</b></p> <p><b>Lighted Models</b></p> <p><b>Terminal Arrangement (Bottom View)</b></p> <p><b>PCB Dimensions (Bottom View)</b></p>



# Installation

## Mounting Switch Unit on a Panel

### Mount Leaf Spring

Press the leaf spring into the fitted groove on the upper surface of the switch unit. For an easier fitting, first fit one side of the leaf spring, then press the other side into the fitting groove.

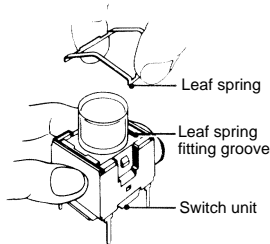

**Note:** Be sure to fit the leaf spring exactly into the groove, and do not allow it to slip out of the groove.

### Mount Flange on Panel

Insert the flange from the front surface of the panel.

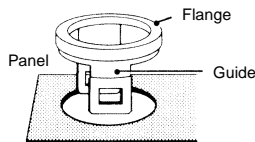

The flange has two opposing guides to facilitate its insertion into the panel cutout hole. Be sure the flange does not remain tilted with respect to the panel surface after being installed.

### Cross Section

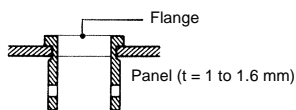

**Note:** The mounting direction of the flange determines the orientation of the switch unit.

### Fit Flange with Switch Unit

While holding the flange, insert the opposing supports into the gaps between the leaf spring and switch unit on the longer sides of the housing, and fit the rectangular hole of the flange with the projections of the switch housing.

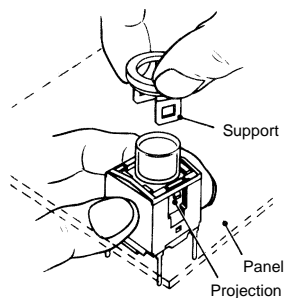

**Note:** Completely remove any burrs on the panel cutout surface; otherwise, the flange and switch unit will not attach solidly.

## Removing Switch Unit

Insert a small flat-bladed screwdriver or tweezers into the flange support exposed on the rear of the panel. Pry up on each side to pull out the switch unit.

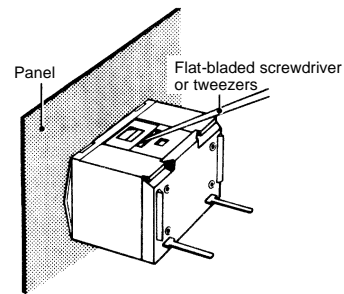

**Note:** Do not pry up the flange support more than necessary or the switch holding portions may be damaged.

# Precautions

## Operation

When operating an A3A, make sure that the A3A has a pushbutton. Do not operate the A3A with a screwdriver or tweezers without mounting a pushbutton to the A3A, otherwise the A3A may malfunction.

## Mounting

When opening a hole on a panel to mount an A3A to the panel, make sure that the hole has no burr.

When mounting a flange to the switching mechanism of an A3A, make sure that the flange and the casing of the switching mechanism are engaged securely.

## Wiring

When soldering the terminals of an A3A, refer to the following.

1. For manual soldering: Use a soldering iron with an input of 30 W to solder the terminals at a temperature of 280°C maximum within five seconds.
2. For automatic soldering: Solder the terminals at a temperature of 240°C within three seconds. Do not impose any external force on the terminals for one minute after the terminals are soldered. Do not solder the terminals at a temperature of 300°C or more, otherwise the resin casing of the A3A will deform and the location of the terminals will change.

Do not pull the terminals of any A3A with a force exceeding 0.6 kgf (5.34 N), otherwise the joint part of the A3A may be damaged.

When soldering the terminals of an A3A, apply non-corrosive rosin flux to the terminals.

After soldering the terminals of an A3A, do not wash the A3A with any solvent.

When mounting an A3A to a PCB and soldering the terminals of the A3A to the PCB, make sure that the flux will not rise above the surface of the PCB.

## Operating Environment

When using an A3A, make sure that dust, metal powder, or oil will not penetrate into the interior of the A3A.

## LED

The back of an A3A with an LED indicates the polarity of the LED. Wire the LED correctly according to the polarity.

An A3A with a built-in LED does not have a limiting resistor. Connect a limiting resistor to the built-in LED.

The resistance can be calculated by using the following expression.

$$R = (E - V_F) / I_F (\Omega)$$

E: Applied voltage (V)

$V_F$ : LED forward voltage (V)

$I_F$ : LED forward current (A)

**Note:** Make sure that the limiting resistor connected to the built-in LED of an A3A satisfies the characteristics of the built-in LED. The mean forward current of the built-in LED must be 8 mA minimum.

## Example

Conditions: Red LED with an  $I_F$  of 10 mA at 24 V and a  $T_a$  of 25°C. From the red LED characteristic below,  $V_F$  will be 2 V when  $I_F$  is 10 mA. Therefore,  $R = (24 \text{ V} - 2 \text{ V}) / 0.01 \text{ A} = 2,200 \Omega$ .

Thus the recommended resistance is 2.2 k $\Omega$  at 0.5 W ( $2 \times I_F^2 R$ ). The permissible wattage of the resistor must be twice as large as the required wattage.

## LED Characteristics ( $V_F - I_F$ Characteristics)

$T_a$ : Ambient Temperature

Red

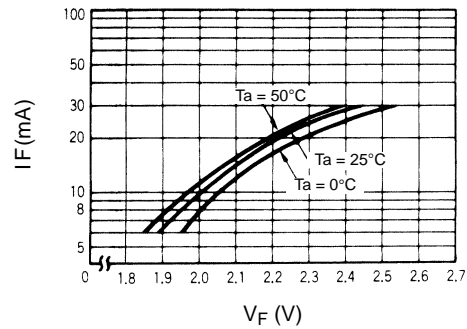

Green

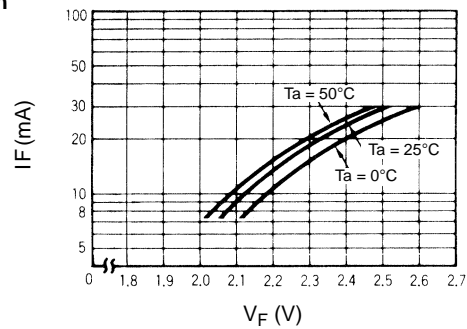

Yellow

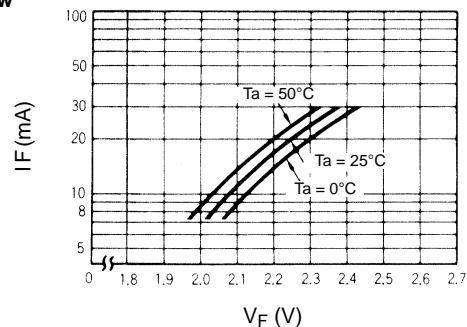

## Pushbutton

When exchanging the pushbutton unit (except the ones for the mechanical indicator models) with a new one, pull out the pushbutton unit from the switch unit, holding the pushbutton unit in the longitudinal direction.

Do not remove the pushbutton unit of the mechanical indicator model.

## Engraving of Pushbutton

Depth of engraving:

0.3 mm max. for illuminating pushbutton

0.5 mm max. for non-illuminating pushbutton

Since the pushbutton unit is made of polycarbonate, use an alcohol-based solvent when cleaning the unit.

## Pressing of Pushbutton

Apply firm pressure to the pushbutton unit when operating it. In doing so, however, do not apply a pressure greater than 1.2 kgf (11.8 N).

**ALL DIMENSIONS SHOWN ARE IN MILLIMETERS.**

To convert millimeters into inches, multiply by 0.03937. To convert grams into ounces, multiply by 0.03527.