

NEW PRODUCT

Description

The ZXLD1374 is an LED driver converter IC with integrated 1.5A low side switch to drive high current LEDs. It is a multi-topology converter enabling it to efficiently control the current through series connected LEDs. The multi-topology enables it to operate in Buck, Boost and Buck-boost configurations.

The 60V capability coupled with its multi-topology capability enables it to be used in a wide range of applications and drive in excess of 16 LEDs in series.

The ZXLD1374 is a modified hysteretic converter using a patent pending control scheme providing high output current accuracy in all three topologies. High accuracy dimming is achieved through DC control and high frequency PWM control.

The ZXLD1374 uses two pins for fault diagnosis. A flag output highlights a fault, while the multi-level status pin gives further information on the exact fault.

Pin Assignments

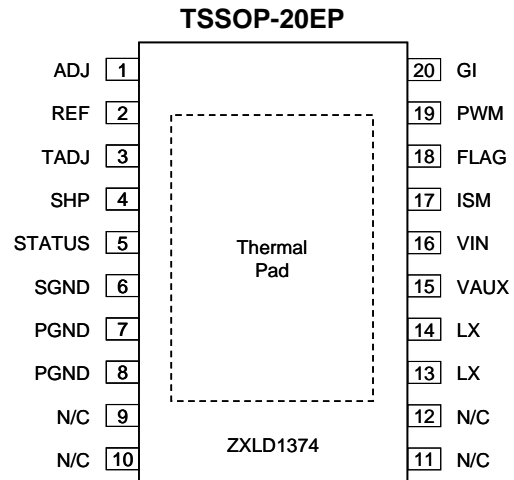

Features

- 0.5% typical output current accuracy
- 6.3 to 60V operating voltage range
- 1.5A integrated low side switch
- LED driver supports Buck, Boost and Buck-boost topologies
- Wide dynamic range dimming
 - 20:1 DC dimming
 - 1000:1 dimming range at 500Hz
- Up to 1MHz switching
- High temperature control of LED current using TADJ
- Green mold compound (No Br, Sb) and RoHS compatible

Typical Application Circuit

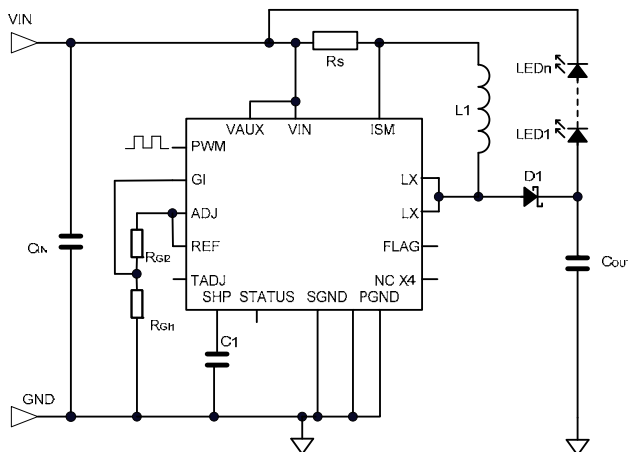

Curve showing LED current vs. T_{LED}

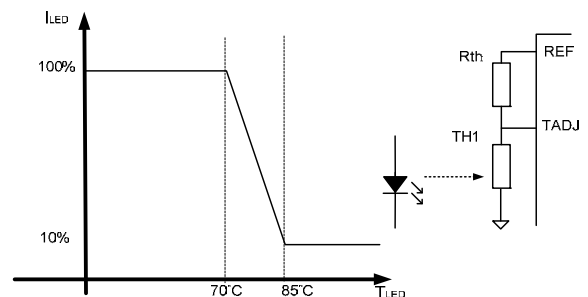

Pin Descriptions

Pin Name	Pin	Type (Note 1)	Description
ADJ	1	I	Adjust input (for dc output current control) Connect to REF to set 100% output current. Drive with dc voltage ($125\text{mV} < V_{\text{ADJ}} < 2.5\text{V}$) to adjust output current from 10% to 200% of set value. The ADJ pin has an internal clamp that limits the internal node to less than 3V. This prevents the LED and power switch from delivering too much current should ADJ get overdriven.
REF	2	O	Internal 1.25V reference voltage output
T _{ADJ}	3	I	Temperature Adjust input for LED thermal current control Connect thermistor/resistor network to this pin to reduce output current above a preset temperature threshold. Connect to REF to disable thermal compensation function (See section on thermal control).
SHP	4	I/O	Shaping capacitor for feedback control loop Connect 100pF $\pm 20\%$ capacitor from this pin to ground to provide loop compensation
STATUS	5	O	Operation status output (analog output) Pin is at 4.5V (nominal) during normal operation. Pin switches to a lower voltage to indicate specific operation warnings or fault conditions (See section on STATUS output). Status pin voltage is low during shutdown mode.
SGND	6	P	Signal ground Connect to 0V and pins 7 and 8.
PGND	7,8	P	Power ground Connect to 0V and pin 6 to maximize copper area.
N/C	9, 10, 11, 12	-	Not Connected internally To maximize PCB copper for thermal dissipation connect to pins 7 and 8.
LX	13, 14	O	Low-side power-switch output
V _{AUX}	15	P	Auxiliary positive supply to internal switch gate driver Connect to V _{IN} , or auxiliary supply from 6V to 15V supply to reduce internal power dissipation (Refer to application section for more details). Decouple to ground with capacitor close to device (refer to Applications section).
V _{IN}	16	P	Input supply to device (6.3V to 60V) Decouple to ground with capacitor close to device (refer to Applications section).
ISM	17	I	Current monitor input Connect current sense resistor between this pin and V _{IN} . The nominal voltage across the resistor is 225mV.
FLAG	18	O	Flag open drain output Pin is high impedance during normal operation. Pin switches low to indicate a fault, or warning condition.
PWM	19	I	Digital PWM output current control Pin driven either by open Drain or push-pull 3.3V or 5V logic levels. Drive with frequency higher than 100Hz to gate output 'on' and 'off' during dimming control. The device enters standby mode when PWM pin is driven with logic low level for more than 15ms nominal (Refer to application section for more details).
GI	20	I	Gain setting input Used to set the LED current in Boost and Buck-boost modes. Connect to ADJ in Buck mode operation. For Boost and Buck-boost modes, connect to resistive divider from ADJ to SGND. This defines the ratio of switch current to LED current (see application section). The GI pin has an internal clamp that limits the internal node to less than 3V. This provides some failsafe should the GI pin get overdriven.
EP	PAD	P	Exposed paddle. Connect to 0V plane for electrical and thermal management.

Notes: 1. Type refers to whether or not pin is an Input, Output, Input/Output or Power supply pin.

Absolute Maximum Ratings (Voltages to GND Unless Otherwise Stated)

Symbol	Parameter	Rating	Unit
V_{IN}	Input supply voltage relative to GND [†]	-0.3 to 65	V
V_{AUX}	Auxiliary supply voltage relative to GND [†]	-0.3 to 65	V
V_{ISM}	Current monitor input relative to GND [†]	-0.3 to 65	V
V_{SENSE}	Current monitor sense voltage ($V_{IN}-V_{ISM}$)	-0.3 to 5	V
V_{LX}	Low side switch output voltage to GND [†]	-0.3 to 65	V
I_{LX}	Low side switch continuous output current	1.8	A
I_{STATUS}	Status pin output current	±1	mA
V_{FLAG}	Flag output voltage to GND [†]	-0.3 to 40	V
$V_{PWM}, V_{ADJ}, V_{TADJ}, V_{GI}$	Other input pins to GND [†]	-0.3 to 5.5	V
T_J	Maximum junction temperature	150	°C
T_{ST}	Storage temperature	-55 to 150	°C

These are stress ratings only. Operation outside the absolute maximum ratings may cause device failure.

Operation at the absolute maximum rating for extended periods may reduce device reliability.

Semiconductor devices are ESD sensitive and may be damaged by exposure to ESD events. Suitable ESD precautions should be taken when handling and transporting these devices.

Notes: [†] For correct operation SGND and PGND should always be connected together.

Package Thermal Data

Thermal Resistance	Package		Unit
Junction-to-Case, θ_{JC}	TSSOP-20EP	4	°C/W

Recommended Operating Conditions

Symbol	Parameter	Performance/Comment	Min	Max	Unit
V_{IN}	Input supply voltage range	Normal operation	8	60	V
		Functional (Note 2)	6.3		
V_{AUX}	Auxiliary supply voltage range (Note 3)	Normal operation	8	60	V
		Functional	6.3		
V_{SENSE}	Differential input voltage	$V_{VIN}-V_{ISM}$, with $0 \leq V_{ADJ} \leq 2.5$	0	450	mV
V_{LX}	Low side switch output voltage			60	V
I_{LX}	Low side switch continuous output current			1.5	A
V_{ADJ}	External dc control voltage applied to ADJ pin to adjust output current	DC brightness control mode from 10% to 200%	0.125	2.5	V
I_{STATUS}	Status pin output current			100	µA
I_{REF}	Reference external load current	REF sourcing current		1	mA
f_{SW}	Recommended switching frequency range (Note 4)		300	1000	kHz
V_{TADJ}	Temperature adjustment (T_{ADJ}) input voltage range		0	V_{REF}	V
f_{PWM}	Recommended PWM dimming frequency range	To maintain 1000:1 resolution	100	500	Hz
		To maintain 200:1 resolution	100	1000	Hz
$t_{PWMH/L}$	PWM pulse width in dimming mode	PWM input high or low	0.005	10	ms
V_{PWMH}	PWM pin high level input voltage		2	5.5	V
V_{PWML}	PWM pin low level input voltage		0	0.4	V
T_J	Operating Junction Temperature Range		-40	125	°C
GI	Gain setting ratio for Boost and Buck-boost modes	Ratio= V_{GI}/V_{ADJ}	0.20	0.50	

Notes: 2. The functional range of V_{IN} is the voltage range over which the device will function. Output current and device parameters may deviate from their normal values for V_{IN} and V_{AUX} voltages between 6.3V and 8V, depending upon load and conditions.

3. V_{AUX} can be driven from a voltage higher than V_{IN} to provide higher efficiency at low V_{IN} voltages, but to avoid false operation; a voltage should not be applied to V_{AUX} in the absence of a voltage at V_{IN} .

4. The device contains circuitry to control the switching frequency to approximately 400kHz. The maximum and minimum operating frequency is not tested in production.

Electrical Characteristics (Test conditions: $V_{IN} = V_{AUX} = 12V$, $T_A = 25^{\circ}C$, unless otherwise specified.)

Symbol	Parameter	Conditions	Min	Typ	Max	Units
Supply and reference parameters						
V_{UV-}	Under-Voltage detection threshold Normal operation to switch disabled	V_{IN} or V_{AUX} falling	5.2	5.6	6.3	V
V_{UV+}	Under-Voltage detection threshold Switch disabled to normal operation	V_{IN} or V_{AUX} rising	5.5	6	6.5	V
I_{Q-IN}	Quiescent current into V_{IN}	PWM pin floating.		1.5	3	mA
I_{Q-AUX}	Quiescent current into V_{AUX}	Output not switching		150	300	μA
I_{SB-IN}	Standby current into V_{IN} .	PWM pin grounded		90	150	μA
I_{SB-AUX}	Standby current into V_{AUX} .	for more than 15ms		0.7	10	μA
V_{REF}	Internal reference voltage	No load	1.237	1.25	1.263	V
ΔV_{REF}	Change in reference voltage with output current	Sourcing 1mA Sinking 25 μA	-5		5	mV
V_{REF_LINE}	Reference voltage line regulation	$V_{IN} = V_{AUX}$, $6.5V < V_{IN} < 60V$	-60	-90		dB
V_{REF_TC}	Reference temperature coefficient			+/-50		ppm/ $^{\circ}C$
DC-DC converter parameters						
V_{ADJ}	External dc control voltage applied to ADJ pin to adjust output current (Note 5)	DC brightness control mode 10% to 200%	0.125	1.25	2.5	V
I_{ADJ}	ADJ input current (Note 5)	$V_{ADJ} \leq 2.5V$ $V_{ADJ} = 5.0V$			100 5	nA μA
V_{GI}	GI Voltage threshold for Boost and Buck-boost modes selection (Note 5)	$V_{ADJ} = 1.25V$			0.8	V
I_{GI}	GI input current (Note 5)	$V_{GI} \leq 2.5V$ $V_{GI} = 5.0V$			100 5	nA μA
I_{PWM}	PWM input current	$V_{PWM} = 5.5V$		36	100	μA
t_{PWMoff}	PWM pulse width (to enter shutdown state)	PWM input low	10	15	25	ms
T_{SDH}	Thermal shutdown upper threshold (LX output inhibited)	Temperature rising.		150		$^{\circ}C$
T_{SDL}	Thermal shutdown lower threshold (LX output re-enabled)	Temperature falling.		125		$^{\circ}C$
High-Side Current Monitor (Pin ISM)						
I_{ISM}	Input Current	Measured into ISM pin and $V_{ISM} = V_{IN}$		11	20	μA
V_{SENSE_acc}	Accuracy of nominal V_{SENSE} threshold voltage	$V_{ADJ} = 1.25V$		± 0.25	± 2	%
V_{SENSE_OC}	Over-current sense threshold voltage		300	350	375	mV

Notes: 5. The ADJ and GI pins have an internal clamp that limits the internal node to less than 3V. This limits the switch current should those pins get overdriven.

NEW PRODUCT

Electrical Characteristics (Test conditions: $V_{IN} = V_{AUX} = 12V$, $T_A = 25^\circ C$, unless otherwise specified.)

Symbol	Parameter	Conditions	Min	Typ	Max	Units
Output Parameters						
V_{FLAGL}	FLAG pin low level output voltage	Output sinking 1mA			0.5	V
$I_{FLAGOFF}$	FLAG pin open-drain leakage current	$V_{FLAG}=40V$			1	μA
V_{STATUS}	STATUS Flag no-load output voltage (Note 6)	Normal operation	4.2	4.5	4.8	V
		Out of regulation (V_{SHP} out of range) (Note 7)	3.3	3.6	3.9	
		V_{IN} under-voltage ($V_{IN} < 5.6V$)	3.3	3.6	3.9	
		Switch stalled (t_{ON} or $t_{OFF} > 100\mu s$)	3.3	3.6	3.9	
		LX over-voltage state ($V_{LX} > 60V$)	2.4	2.7	3.0	
		Over-temperature ($T_J > 125^\circ C$)	1.5	1.8	2.1	
		Excess sense resistor current ($V_{SENSE} > 0.375V$)	0.6	0.9	1.2	
		Excessive switch current ($I_{SW} > 1.5A$)	0.6	0.9	1.2	
R_{STATUS}	Output impedance of STATUS output	Normal operation		10		k Ω
Low side switch output (LX pins tied together)						
I_{LX-LG}	Low side switch leakage current	Output stage off, $V_{LX} = 60V$ (Note 8)		60		μA
$R_{DS(ON)}$	LX pin MOSFET on resistance	$I_{LX} = 1.5A$ ($t_{ON} < 100\mu s$)		0.5	0.8	Ω
t_{PDHL}	Propagation delay high-low	$V_{SENSE} = 225mV \pm 30\%$, $C_L = 680pF$, $R_L = 120\Omega$		86		ns
t_{PDLH}	Propagation delay low-high			131		ns
t_{LXR}	LX output rise time			208		ns
t_{LXF}	LX output fall time			12		ns
t_{STALL}	Time to assert 'STALL' flag and warning on STATUS output (Note 9)		LX low or high		100	170
LED Thermal control circuit (TADJ) parameters						
V_{TADJH}	Upper threshold voltage	Onset of output current reduction (V_{TADJ} falling)	560	625	690	mV
V_{TADJL}	Lower threshold voltage	Output current reduced to <10% of set value (V_{TADJ} falling)	380	440	500	mV
I_{TADJ}	TADJ pin Input current	$V_{TADJ} = 1.25V$			1	μA

- Notes:
- In the event of more than one fault/warning condition occurring, the higher priority condition will take precedence. E.g. 'Excessive coil current' and 'Out of regulation' occurring together will produce an output of 0.9V on the STATUS pin. The voltage levels on the STATUS output assume the internal regulator to be in regulation and $V_{ADJ} \leq V_{REF}$. A reduction of the voltage on the STATUS pin will occur when the voltage on V_{IN} is near the minimum value of 6V.
 - Flag is asserted if $V_{SHP} < 2.5V$ or $V_{SHP} > 3.5V$
 - With the device still in switching mode the LX pin has an over-voltage detection circuit connected to it with a resistance of approximately 1M Ω .
 - If t_{ON} exceeds t_{STALL} , LX turns off and then an initiate a restart cycle occurs. During this phase, ADJ is grounded internally and the SHP pin is switched to its nominal operating voltage, before operation is allowed to resume. Restart cycles will be repeated automatically until the operating conditions are such that normal operation can be sustained. If t_{OFF} exceeds t_{STALL} , the switch will remain off until normal operation is possible.

Typical Characteristics

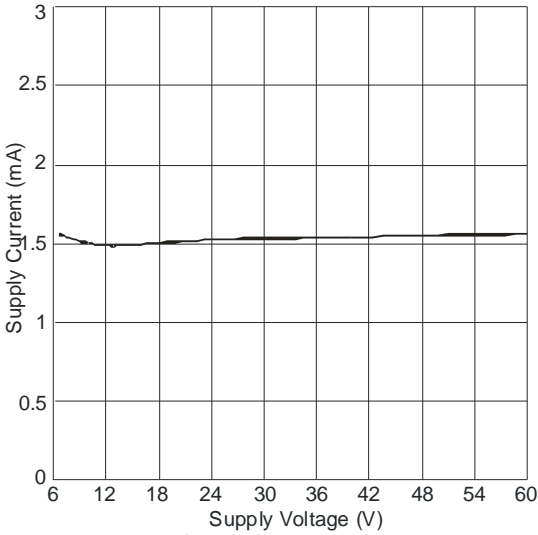

Figure 1. Supply Current vs. Supply Voltage

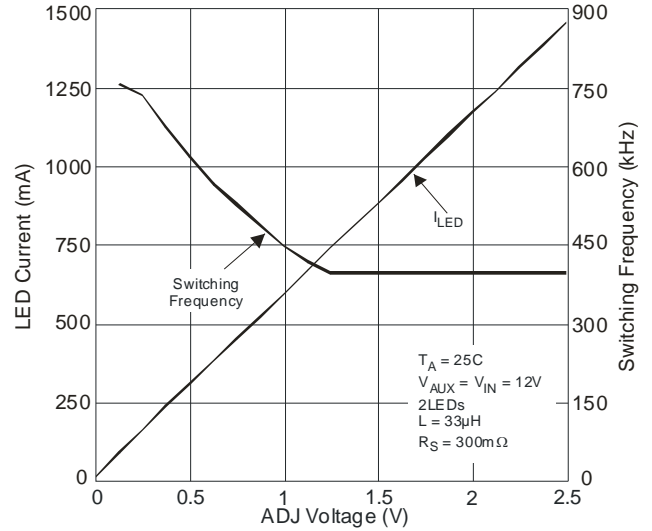

Figure 2. Buck LED Current, Switching Frequency vs. V_{ADJ}

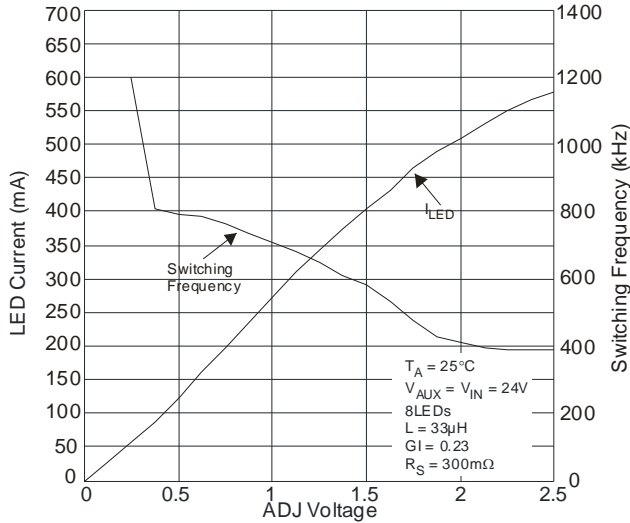

Figure 3. Buck-Boost LED Current, Switching Frequency vs. V_{ADJ}

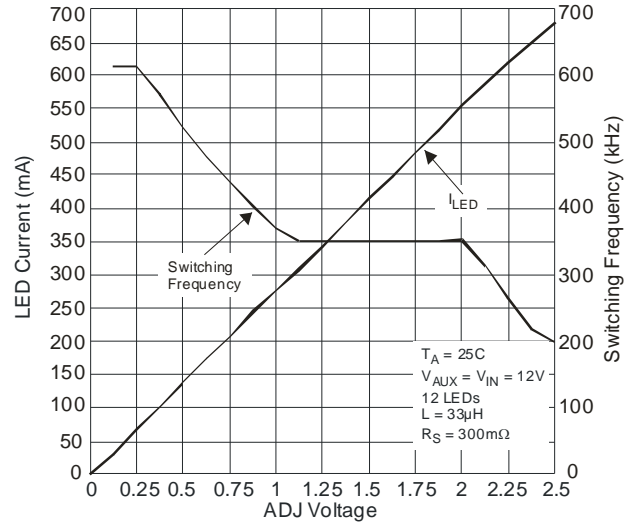

Figure 4. Boost LED Current, Switching Frequency vs. V_{ADJ}

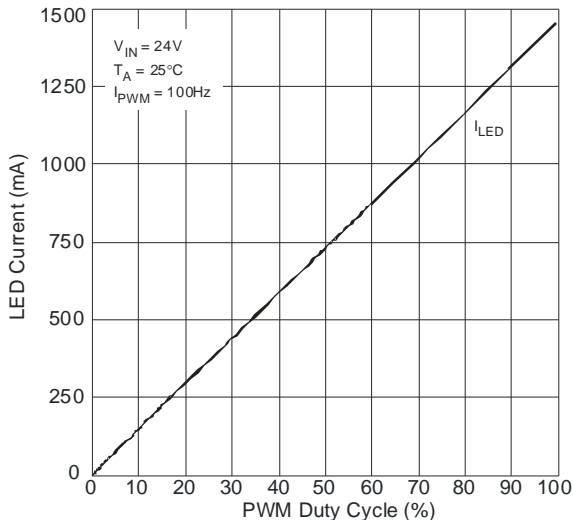

Figure 5. I_{LED} vs. PWM Duty Cycle

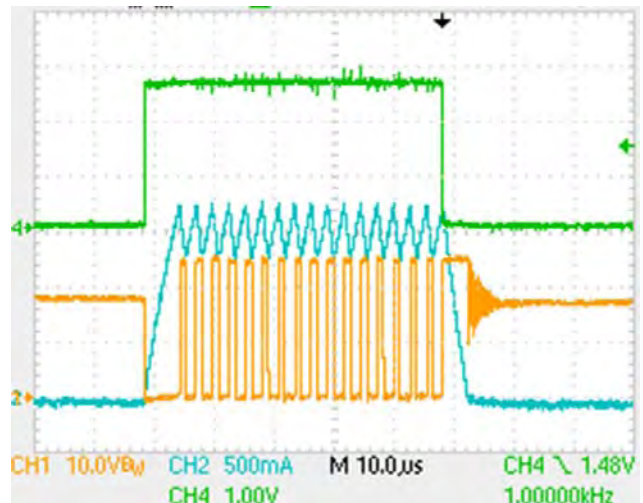

Figure 6. I_{LED} vs time - PWM pin transient response

NEW PRODUCT

Typical Characteristics

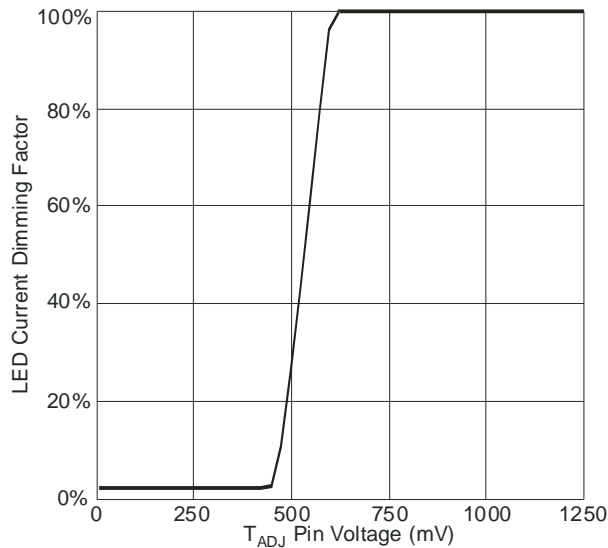

Figure 7. LED Current vs. T_{ADJ} Voltage

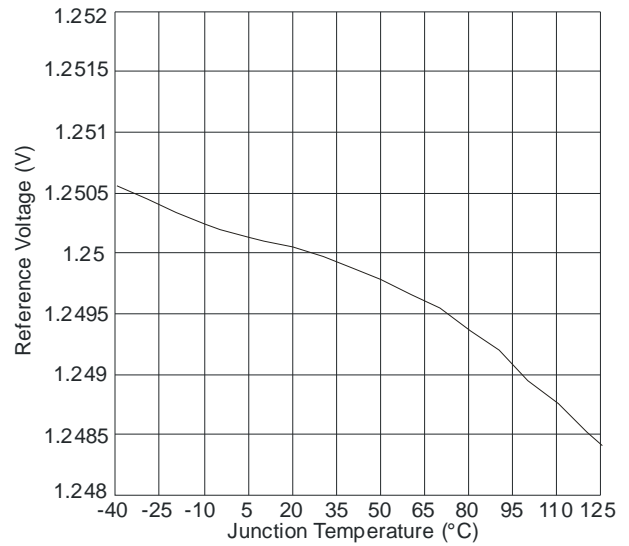

Figure 8. V_{REF} vs. Temperature

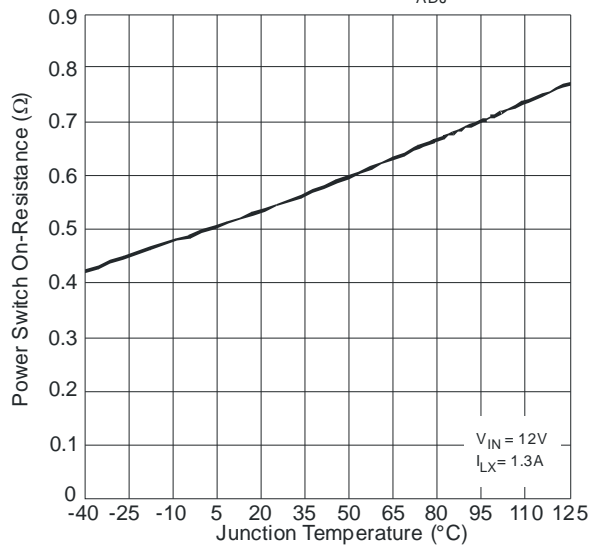

Figure 9. $R_{DS(ON)}$ vs. Temperature

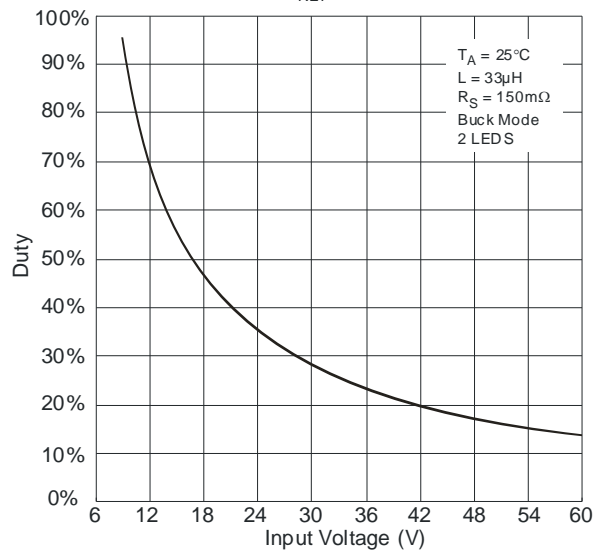

Figure 10. Duty Cycle vs. Input Voltage

NEW PRODUCT

Typical Characteristics – Buck Mode – $R_S = 146m\Omega$ – $L = 33\mu H$ – $I_{LED} = 1.5A$

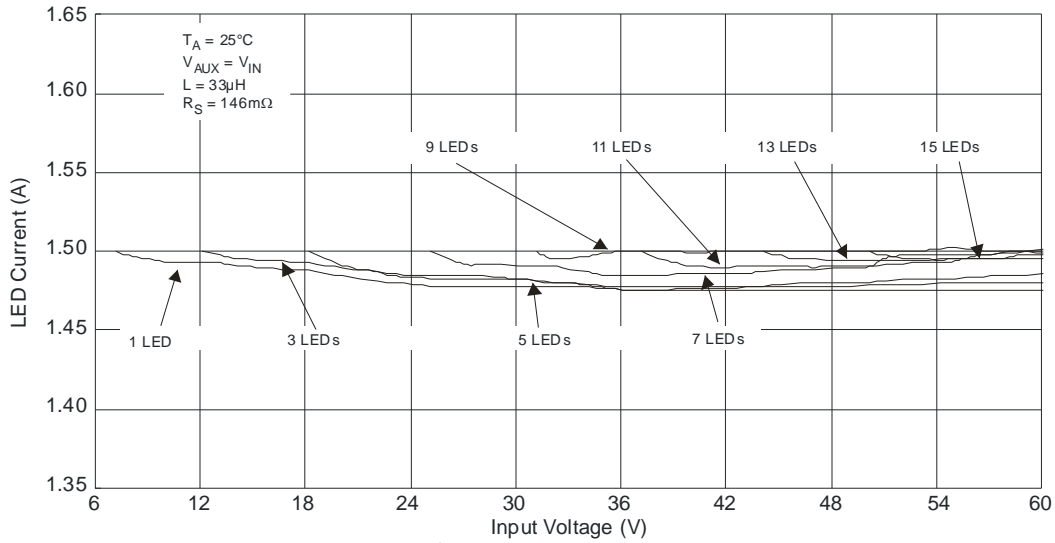

Figure 11. Load Current vs. Input Voltage and Number of LED

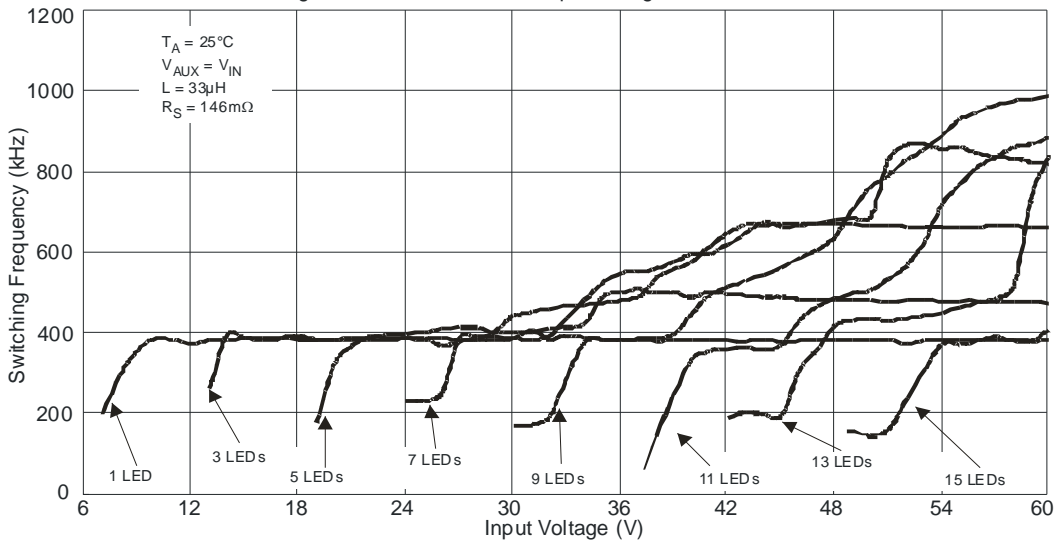

Figure 12. Frequency vs. Input Voltage and Number of LED

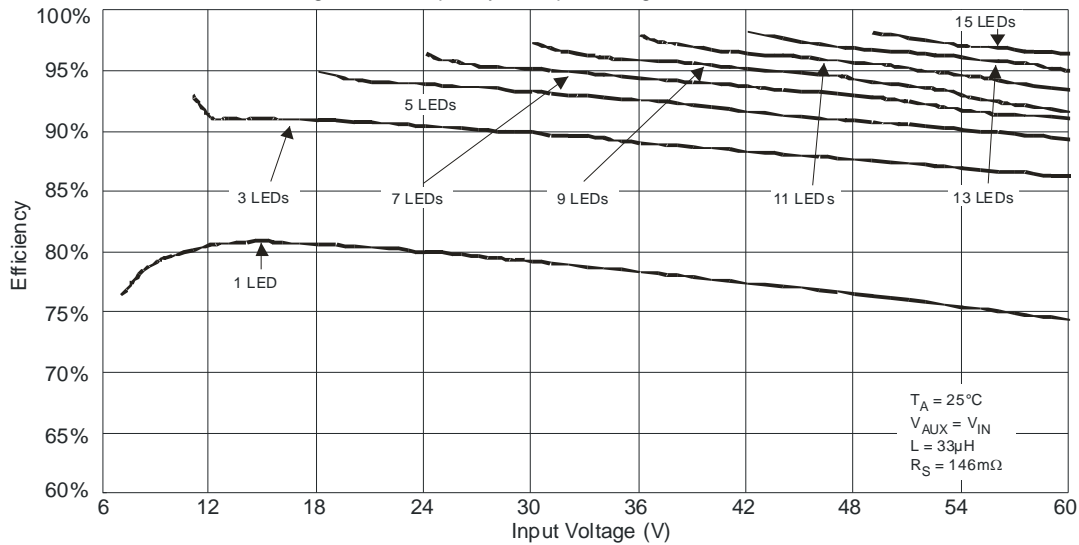

Figure 13. Efficiency vs. Input Voltage and Number of LED

NEW PRODUCT

Typical Characteristics – Buck Mode – $R_S = 291m\Omega$ - $L = 33\mu H$ - $I_{LED} = 750mA$

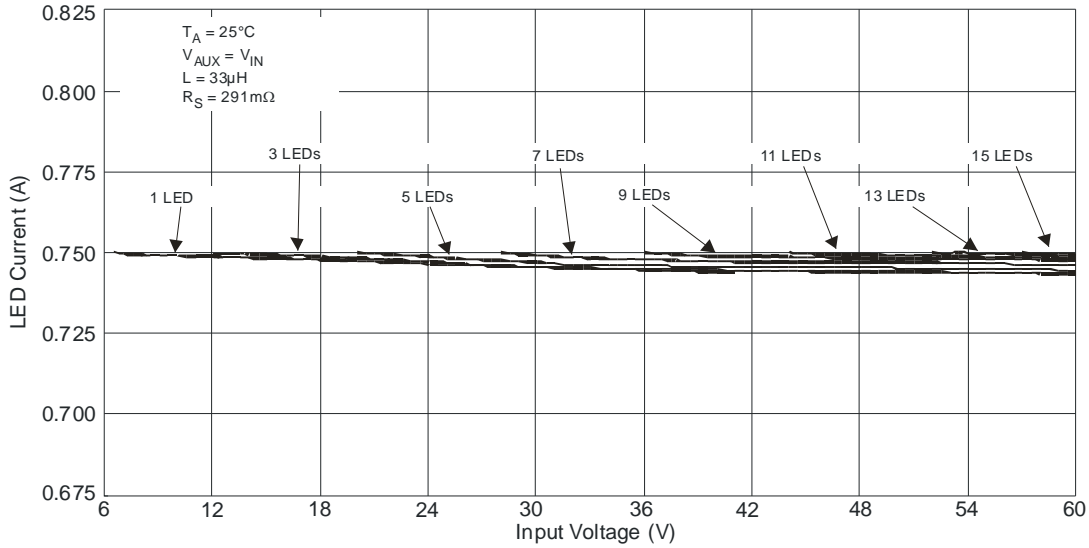

Figure 14. I_{LED} vs. Input Voltage and Number of LED

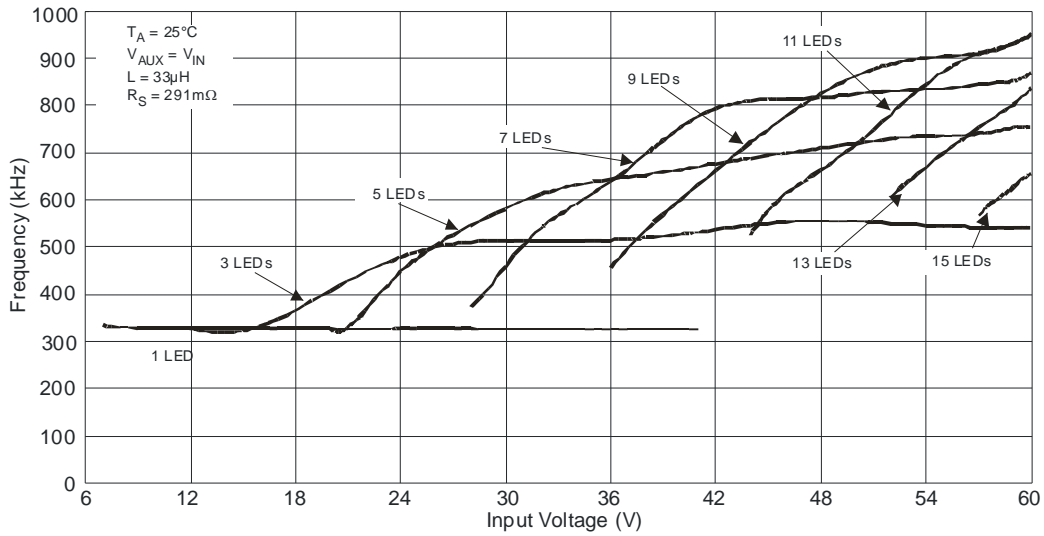

Figure 15. Frequency ZXLD1374 - Buck Mode = $L = 47\mu H$

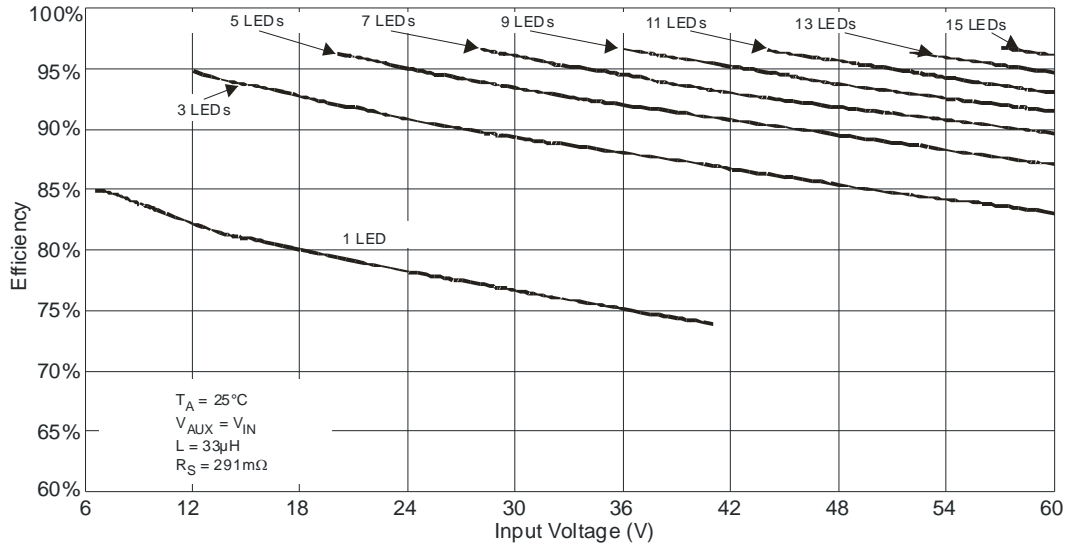

Figure 16. Efficiency vs. Input Voltage and Number of LED

NEW PRODUCT

Typical Characteristics – Boost mode – $R_S = 150m\Omega$ - $L = 33\mu H$ – $I_{LED} = 325mA$ – $G_{IRATIO} = 0.21$

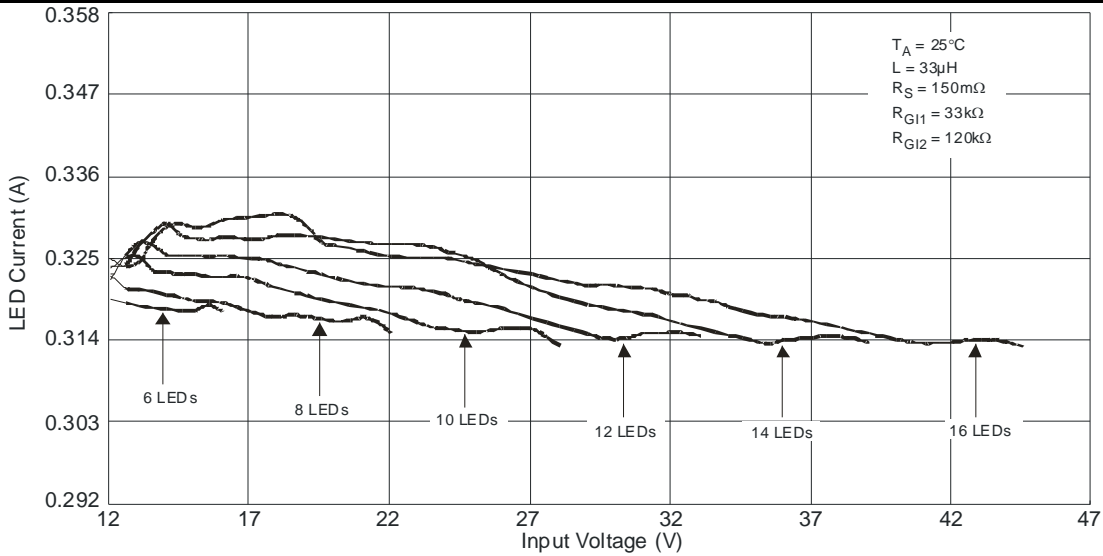

Figure 17. I_{LED} vs. Input and Number of LED

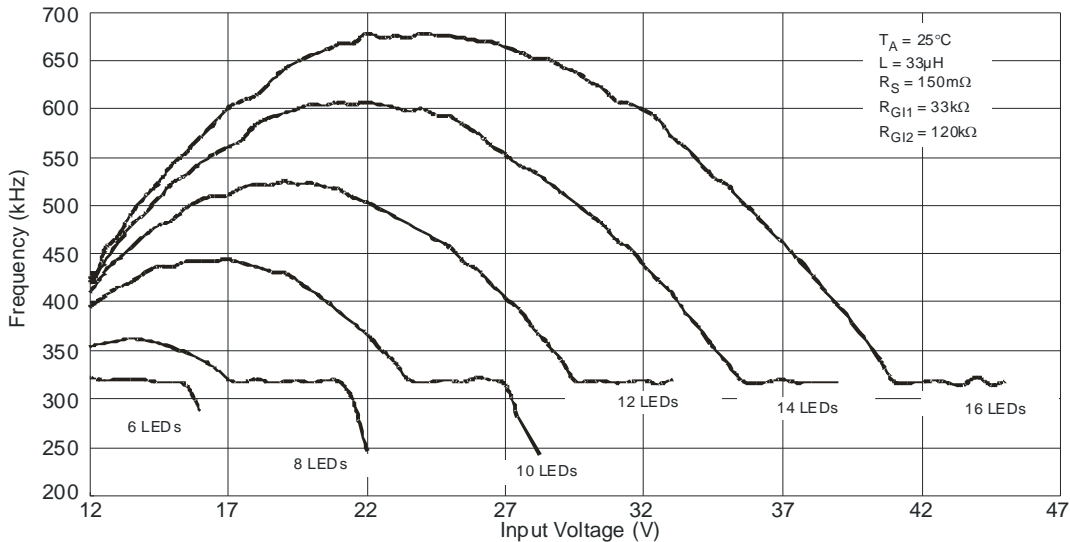

Figure 18. Frequency vs. Input Voltage and Number LED

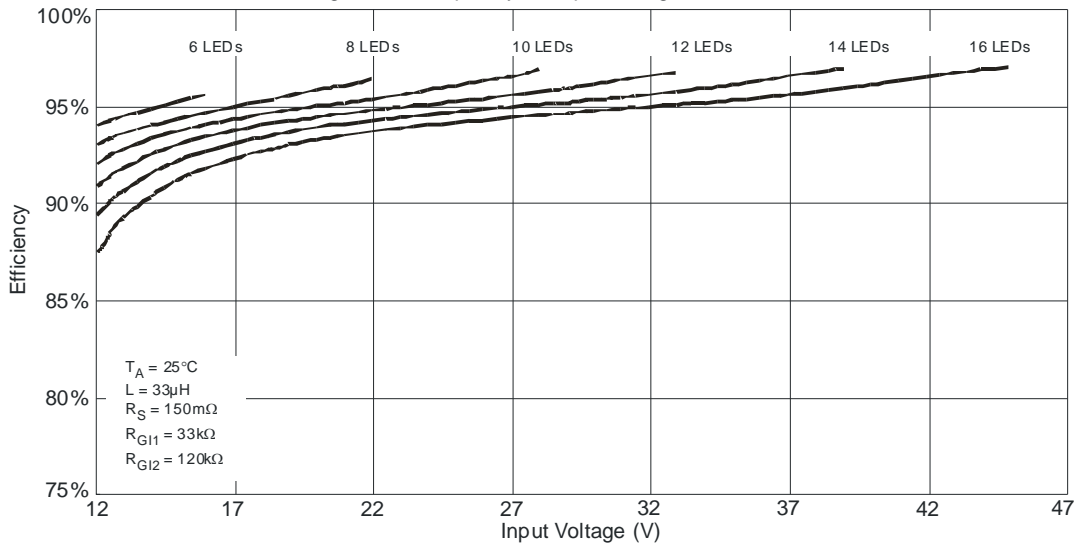
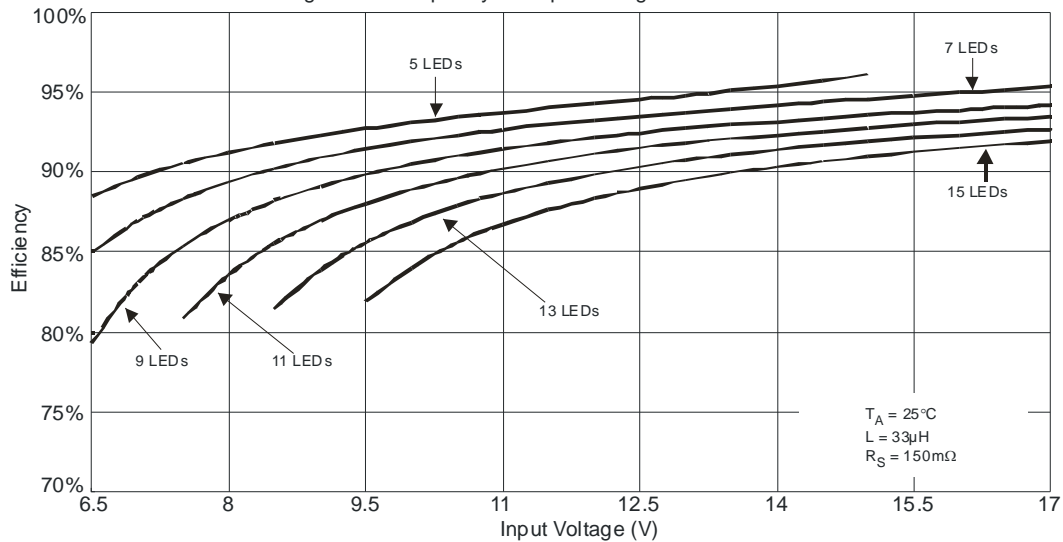
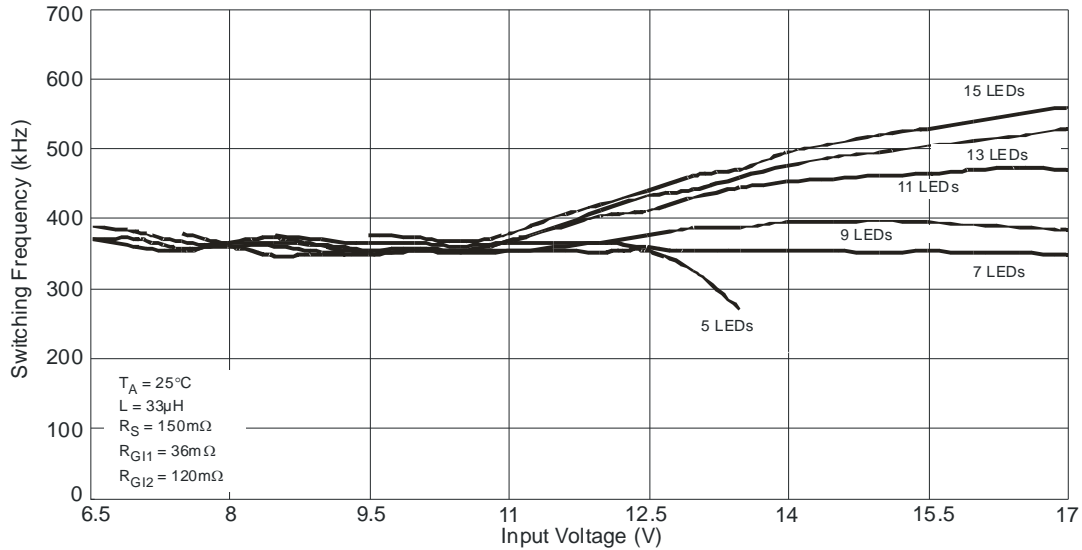
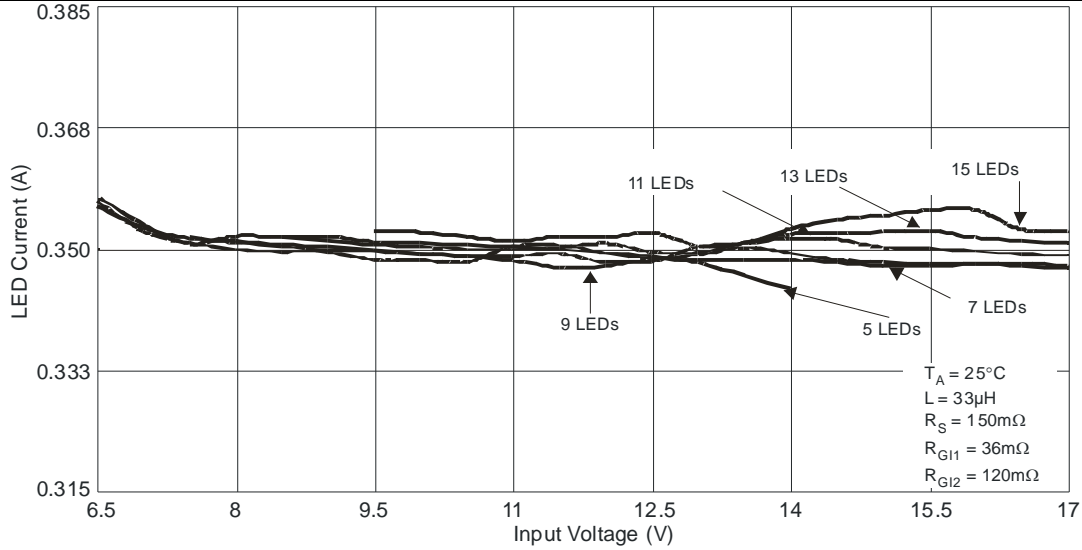

Figure 19. Efficiency vs. Input Voltage and Number of LED

NEW PRODUCT

Typical Characteristics – Boost mode – $R_S = 150m\Omega$ – $L = 33\mu H$ – $I_{LED} = 350mA$ – $G1_{RATIO} = 0.23$ – with bootstrap



NEW PRODUCT

Typical Characteristics – Buck-boost mode – $R_S = 150\text{m}\Omega$ – $L = 33\mu\text{H}$ – $I_{LED} = 350\text{mA}$ – $G1_{RATIO} = 0.23$ – with bootstrap

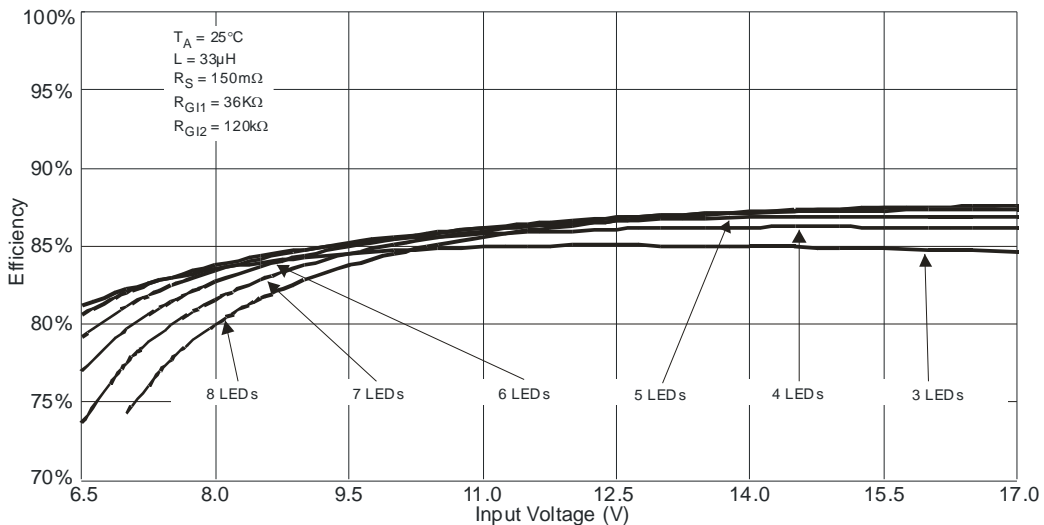
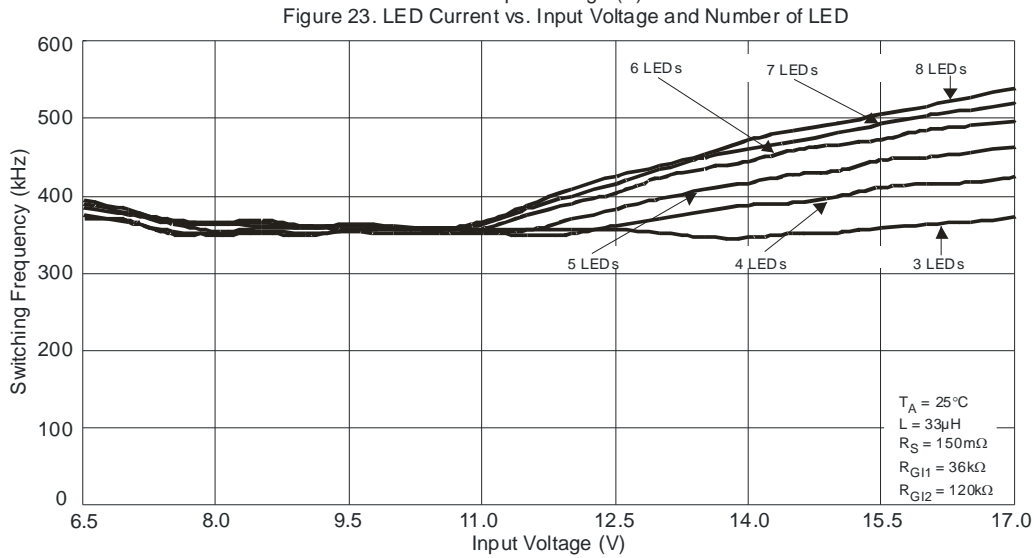
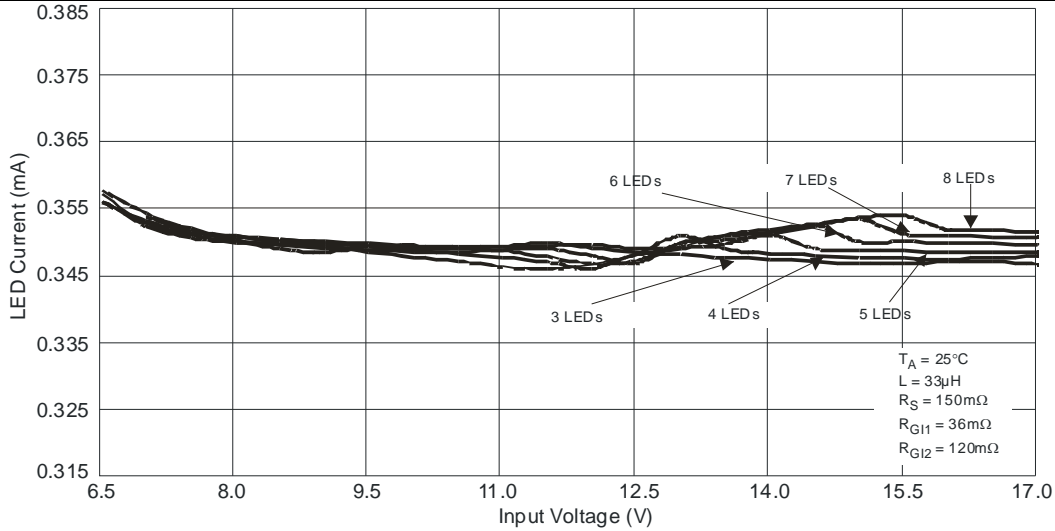

NEW PRODUCT

Applications Information

The ZXLD1374 is a high accuracy hysteretic inductive Buck/Boost/Buck-boost converter with an internal NMOS switch designed to be used for current-driving single or multiple series-connected LEDs. The device can be configured to operate in Buck, Boost, or Buck-boost modes by suitable configuration of the external components as shown in the schematics shown in the device operation description.

Device Operation

a) Buck mode

The most simple Buck circuit is shown in Figure 26

LED current control in Buck mode is achieved by sensing the coil current in the sense resistor R_s , connected between the two inputs of a current monitor within the control loop block. An output from the control loop drives the input of a comparator which drives the gate of the internal NMOS switch transistor.

When the switch is on, current flows from V_{IN} , via R_s , LED, coil and switch to ground. This current ramps up until an upper threshold value is reached. At this point the switch is turned off and the current flows via R_s , LED, coil and $D1$ back to V_{IN} . When the coil current has ramped down to a lower threshold value the switch is turned on again and the cycle of events repeats, resulting in continuous oscillation.

The average current in the LED and coil is equal to the average of the maximum and minimum threshold currents. The ripple current (hysteresis) is equal to the difference between the thresholds.

The control loop maintains the average LED current at the set level by adjusting the thresholds continuously to force the average current in the coil to the value demanded by the voltage on the ADJ pin. This minimizes variation in output current with changes in operating conditions.

The control loop also attempts to minimize changes in switching frequency by varying the level of hysteresis. The hysteresis has a defined minimum (typ 5%) and a maximum (typ 20%), the frequency may deviate from nominal in extreme conditions. Loop compensation is achieved by a single external capacitor $C1$, connected between SHP and SGND.

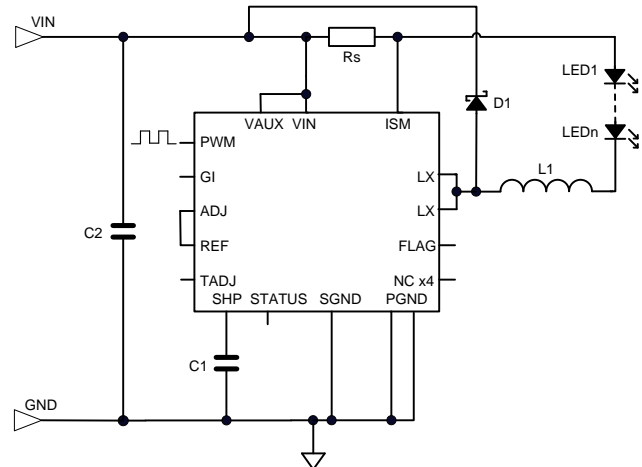

Figure 26. Buck Configuration

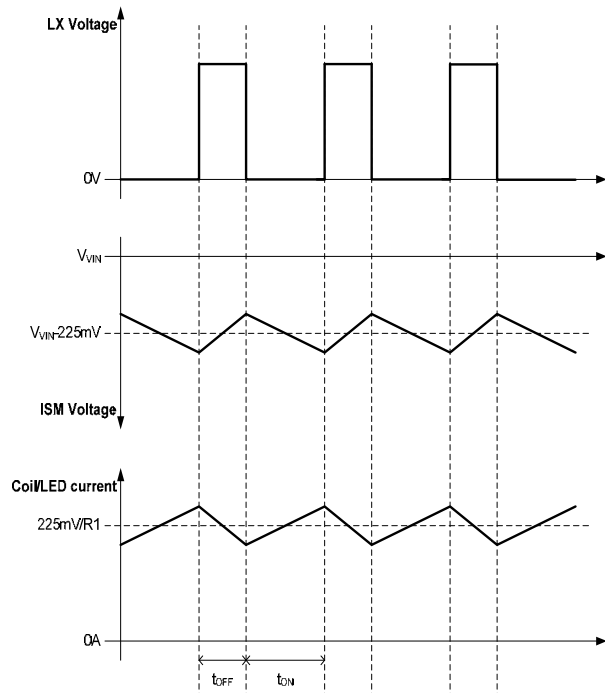

Figure 27. Operating Waveforms (Buck Mode)

NEW PRODUCT

Applications Information (Continued)

b) Boost and Buck-boost modes

A basic ZXLD1374 application circuit for Buck-boost and Boost modes is shown in Figure 28.

Control in Boost and Buck-boost mode is achieved by sensing the coil current in the series resistor R_s , connected between the two inputs of a current monitor within the control loop block.

An output from the control loop drives the input of a comparator which drives the gate of the internal NMOS switch transistor. In Boost and Buck-boost modes, when the switch is on, current flows from V_{IN} , via R_s , coil and switch to ground. This current ramps up until an upper threshold value is reached. At this point the switch is turned off and the current flows via R_s , coil, D1 and LED back to V_{IN} (Buck-boost mode), or GND (Boost mode).

When the coil current has ramped down to a lower threshold value the switch is turned on again and the cycle of events repeats, resulting in continuous oscillation. The average current in the coil is equal to the average of the maximum and minimum threshold currents and the ripple current (hysteresis) is equal to the difference between the thresholds.

The average current in the LED is always less than the average current in the coil and the ratio between these currents is set by the values of external resistors R_{G11} and R_{G12} . The peak LED current is equal to the peak coil current. The control loop maintains the average LED current at the set level by adjusting the thresholds and the hysteresis continuously to force the average current in the coil to the value demanded by the voltage on the ADJ and GI pins. This minimizes variation in output current with changes in operating conditions. Loop compensation is achieved by a single external capacitor C2, connected between SHP and SGND.

For more detailed descriptions of device operation and for choosing external components, please refer to the application circuits and descriptions in the later sections of this specification.

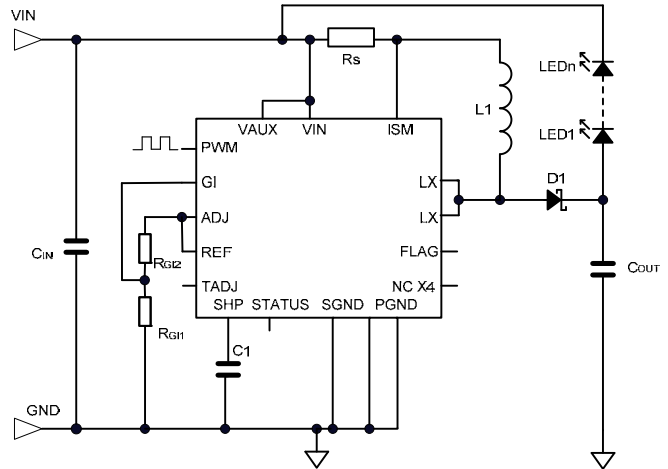

Figure 28. Boost and Buck-boost Configuration

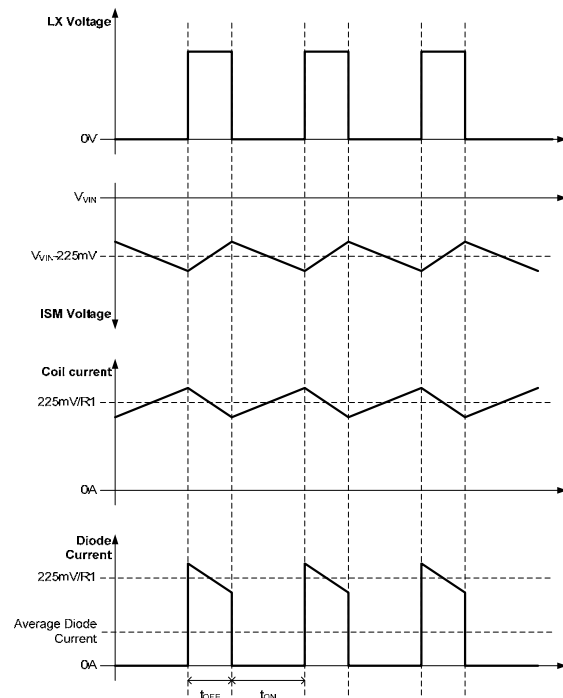

Figure 29. Operating Waveforms (Boost and Buck-boost Modes)

NEW PRODUCT

Applications Information (Continued)

Component Selection

External component selection is driven by the characteristics of the load and the input supply, since this will determine the kind of topology being used for the system.

Component selection starts with the current setting procedure and the inductor/frequency setting. Finally after selecting the freewheeling diode and the output capacitor (if needed), the application section will cover the PWM dimming and thermal feedback.

Setting the output current

The first choice when defining the output current is whether the device is operating with the load in series with the sense resistor (Buck mode) or whether the load is not in series with the sense resistor (Boost and Buck-boost modes).

The output current setting depends on the choice of the sense resistor R_S , the voltage on the ADJ pin and the voltage on the GI pin, according to the device working mode. The sense resistor R_S sets the coil current I_{RS} .

The ADJ pin may be connected directly to the internal 1.25V reference (V_{REF}) to define the nominal 100% LED current. The ADJ pin can also be overdriven with an external dc voltage between 125mV and 2.5V to adjust the LED current proportionally between 10% and 200% of the nominal value.

ADJ and GI are high impedance inputs within their normal operating voltage ranges. An internal 2.6V clamp protects the device against excessive input voltage and limits the maximum output current to approximately 4% above the maximum current set by V_{ADJ} if the maximum input voltage is exceeded.

Below are provided the details of the LED current calculation both when the load in series with the sense resistor (Buck mode) and when the load is not in series with the sense resistor (Boost and Buck-boost modes).

In Buck mode, GI is connected to ADJ which results in the average LED current (I_{LED}) equal to the average sense resistor/coil current (I_{RS}). A loop gain compensation factor, K , compensates for GI being connected to ADJ. This gives the following equation for I_{LED} :

$$I_{LED} = I_{RS} = K \frac{225mV}{R_S} \frac{V_{ADJ}}{V_{REF}} = \frac{218mV}{R_S} \frac{V_{ADJ}}{V_{REF}} \text{ where } K = 0.97$$

If ADJ (and GI pin) is directly connected to V_{REF} , this becomes:

$$I_{LED} = I_{RS} = \frac{218mV}{R_S}$$

Therefore:

$$R_S = \frac{218mV}{I_{LED}}$$

In Boost and Buck-boost mode GI is connected to ADJ through a voltage divider.

With V_{ADJ} equal to V_{REF} , the ratio defined by the resistor divider at the GI pin determines the ratio of average LED current (I_{LED}) to average sense resistor/coil current.

$$I_{COIL} = \frac{I_{LED}}{1-D} \Rightarrow V_{RS} = I_{COIL} \times R_S = \frac{I_{LED} \times R_S}{1-D}$$

Where

$$\begin{aligned} I_{LED} &= \frac{V_{GI}}{V_{ADJ}} \frac{V_{ADJ}}{V_{REF}} \frac{0.225}{R_S} = \\ &= \frac{R_{GI1}}{(R_{GI1} + R_{GI2})} \frac{V_{ADJ}}{V_{REF}} \frac{0.225}{R_S} \end{aligned}$$

Therefore:

$$R_S = \frac{R_{GI1}}{(R_{GI1} + R_{GI2})} \frac{225mV}{I_{LED}} \frac{V_{ADJ}}{V_{REF}}$$

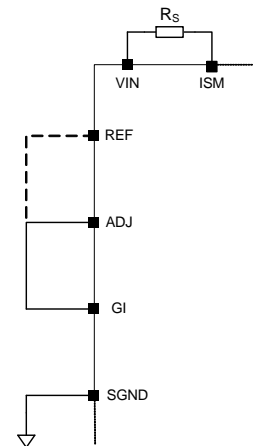

Figure 30: Buck configuration

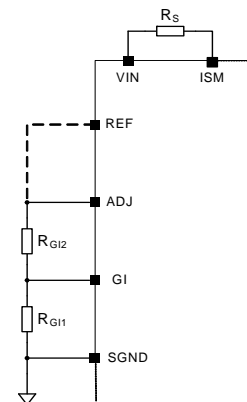

Figure 31: Boost and Buck-boost connection

Applications Information (Continued)

When the ADJ pin is directly connected to the REF pin, this becomes:

$$R_s = \frac{R_{G1}}{(R_{G1} + R_{G2})} \frac{225\text{mV}}{I_{LED}}$$

Note that the average LED current for a Boost or Buck-boost converter is always less than the average sense resistor current. For the ZXLD1374, the recommended potential divider ratio is given by:

$$0.2 \leq \frac{R_{G1}}{(R_{G1} + R_{G2})} \leq 0.50$$

It is possible to use a different combination of GI pin voltages and sense resistor values to set the LED current.

In general the design procedure to follow is:

- Define input conditions in terms of V_{IN} and I_{IN}
- Set output conditions in terms of LED current and the number of LEDs
- Define controller topology – Buck, Boost or Buck-boost

Calculate the maximum duty-cycle as:

Buck mode

$$D_{MAX} = \frac{V_{LEDS}}{V_{INMIN}}$$

Boost mode

$$D_{MAX} = \frac{V_{LEDS} - V_{INMIN}}{V_{LEDS}}$$

Buck-boost mode

$$D_{MAX} = \frac{V_{LEDS}}{V_{LEDS} + V_{INMIN}}$$

Set the appropriate GI_{RATIO} according to the circuit duty and the max switch current admissible limitations

$$GI_{RATIO} = \frac{V_{GI}}{V_{ADJ}} = \frac{R_{G1}}{(R_{G1} + R_{G2})} \leq 1 - D_{MAX}$$

- Set R_{G1} as:

$$10\text{k}\Omega \leq R_{G1} \leq 200\text{k}\Omega$$

- Calculate R_{G2} as:

$$R_{G2} \approx \frac{D_{MAX}}{1 - D_{MAX}} \times R_{G1}$$

- Calculate the sense resistor as:

$$R_s = \frac{R_{G1}}{(R_{G1} + R_{G2})} \frac{225\text{mV}}{I_{LED}}$$

If the potential divider ratio is greater than 0.64, the device detects that Buck-mode operation is desired and the output current will deviate from the desired value.

Applications Information (Continued)

For example, as in the typical application circuit, in order to get $I_{LED} = 350\text{mA}$ with $I_{RS} = 1.5\text{A}$ the ratio has to be set as:

$$\frac{I_{LED}}{I_{RS}} = \frac{V_{GI}}{V_{ADJ}} = \frac{R_{GI1}}{(R_{GI1} + R_{GI2})} \approx 0.23$$

Setting $R_{GI1} = 33\text{k}\Omega$ it results

$$R_{GI2} = R_{GI1} \left(\frac{V_{ADJ}}{V_{GI}} - 1 \right) = 110\text{k}\Omega$$

This will result in:

$$R_s = \frac{R_{GI1}}{(R_{GI1} + R_{GI2})} \frac{225\text{mV}}{I_{LED}} = 150\text{m}\Omega$$

Table 1 shows typical resistor values used to determine G_{I_RATIO} with E24 series resistors:

Table 1

G_{I_RATIO}	R_{GI1}	R_{GI2}
0.2	30k Ω	120k Ω
0.25	33k Ω	100k Ω
0.3	39k Ω	91k Ω
0.35	30k Ω	56k Ω
0.4	100k Ω	150k Ω
0.45	51k Ω	62k Ω
0.5	30k Ω	30k Ω

The values shown have been chosen so that they do not load REF too much or create offset errors due to the GI pin input current. A ZXLD1374 calculator is available from <http://www.diodes.com/destools/calculators.html> that will help with component selection.

INDUCTOR/FREQUENCY SELECTION

Recommended inductor values for the ZXLD1374 are in the range 22 μH to 100 μH . The chosen coil should have a saturation current higher than the peak sensed current and a continuous current rating above the required mean sensed current by at least 50%.

The inductor value should be chosen to maintain operating duty cycle and switch 'on/off' times within the recommended limits over the supply voltage and load current range.

The frequency compensation mechanism inside the chip tends to keep the frequency within the range 300kHz ~ 400kHz in most of the operating conditions. Nonetheless, the controller allows for higher frequencies when either the number of LEDs or the input voltage increases.

The graphs below can be used to select a recommended inductor to maintain the ZXLD1374 switching frequency within a predetermined range when used in different topologies.

Applications Information (Continued)

INDUCTOR/FREQUENCY SELECTION

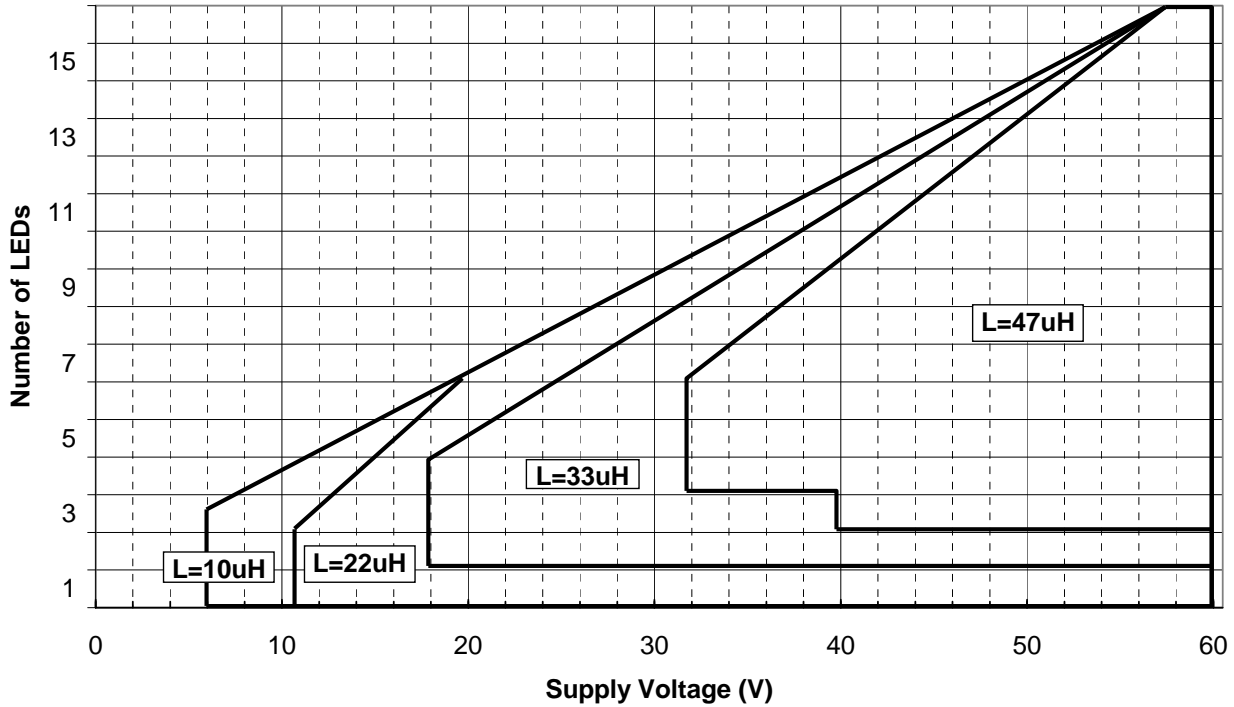

Figure 32: 1.5A Buck mode inductor selection for target frequency of 400 kHz

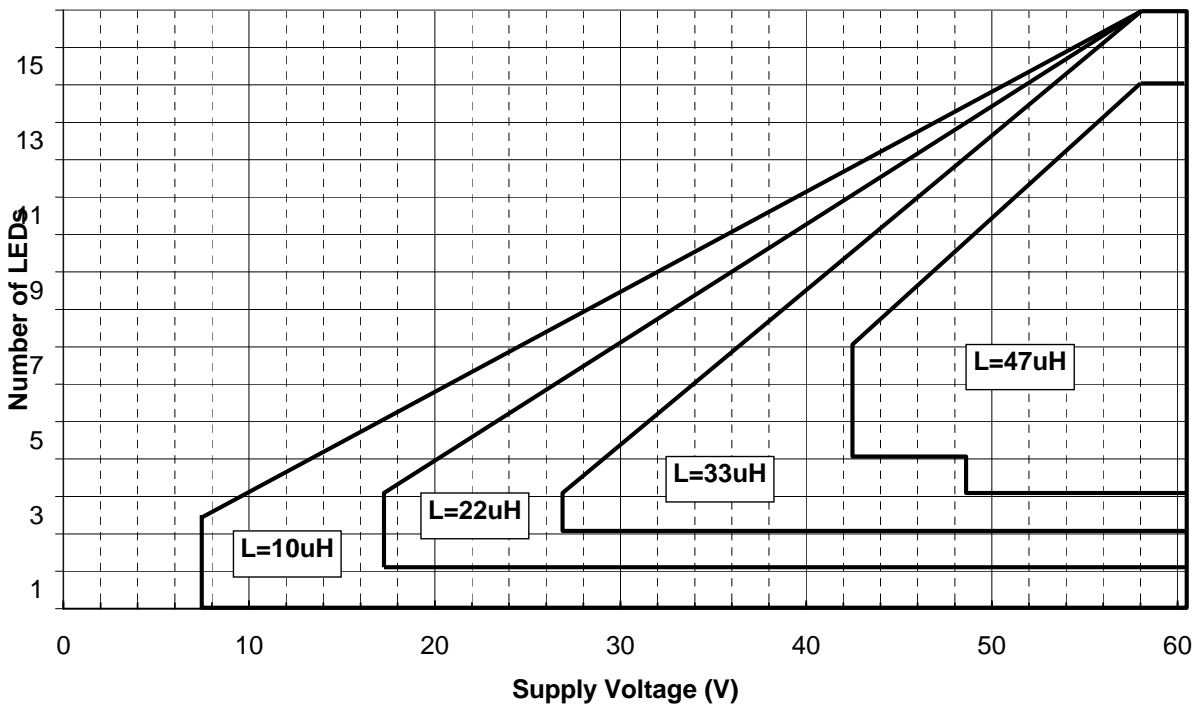

Figure 33: 1.5A Buck mode inductor selection for target frequency > 500kHz

NEW PRODUCT

Applications Information (Continued)

For example, in a Buck configuration ($V_{IN} = 24V$ and 6 LEDs), with a load current of 1.5A; if the target frequency is around 400 kHz, the Ideal inductor size is $L = 33\mu H$.

The same kind of graphs can be used to select the right inductor for a Buck configuration and a LED current of 750mA, as shown in figures 34 and 35.

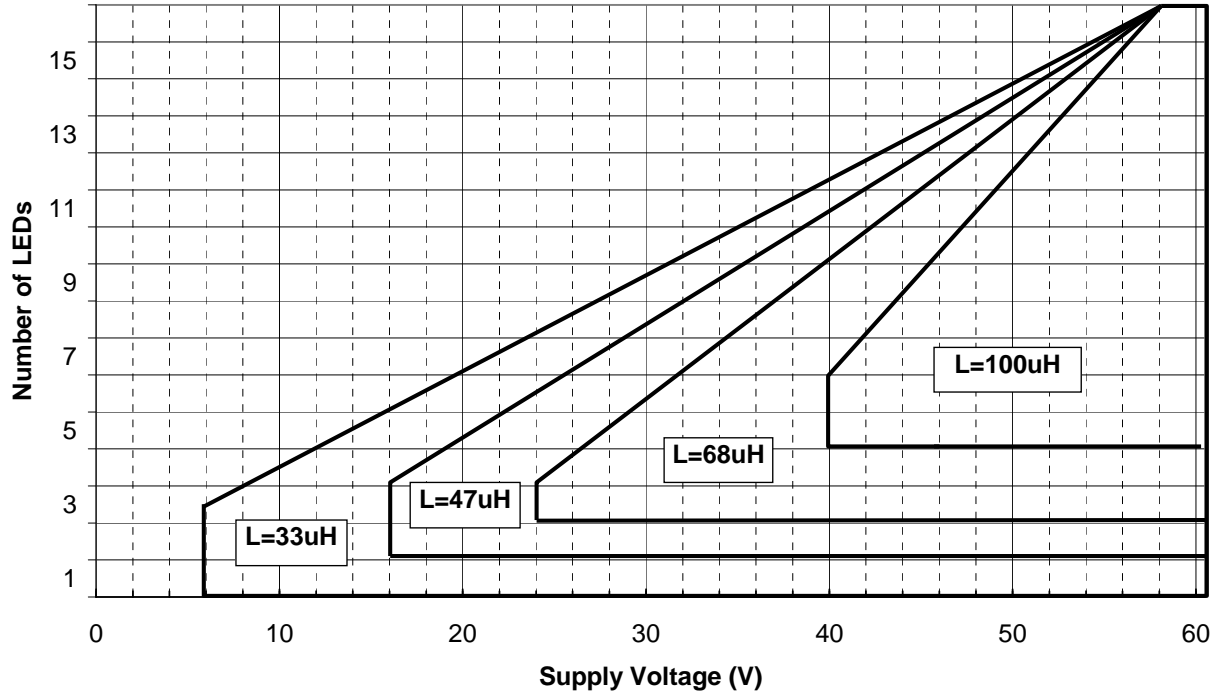

Figure 34: 750mA Buck mode inductor selection for target frequency 400kHz

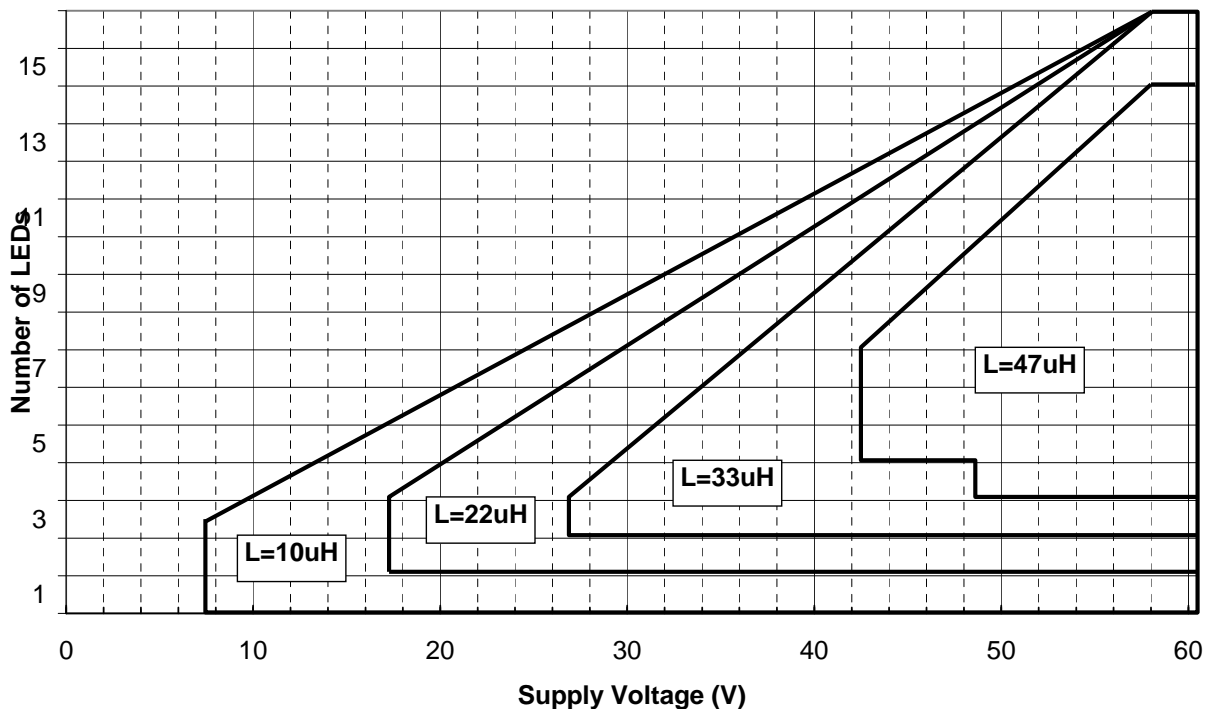

Figure 35: 750mA Buck mode inductor selection for target frequency > 500kHz

NEW PRODUCT

Applications Information (Continued)

In the case of the Buck-boost topology, the following graphs guide the designer to select the inductor for a target frequency of 400kHz (figure 36) or higher than 500kHz (figure 37).

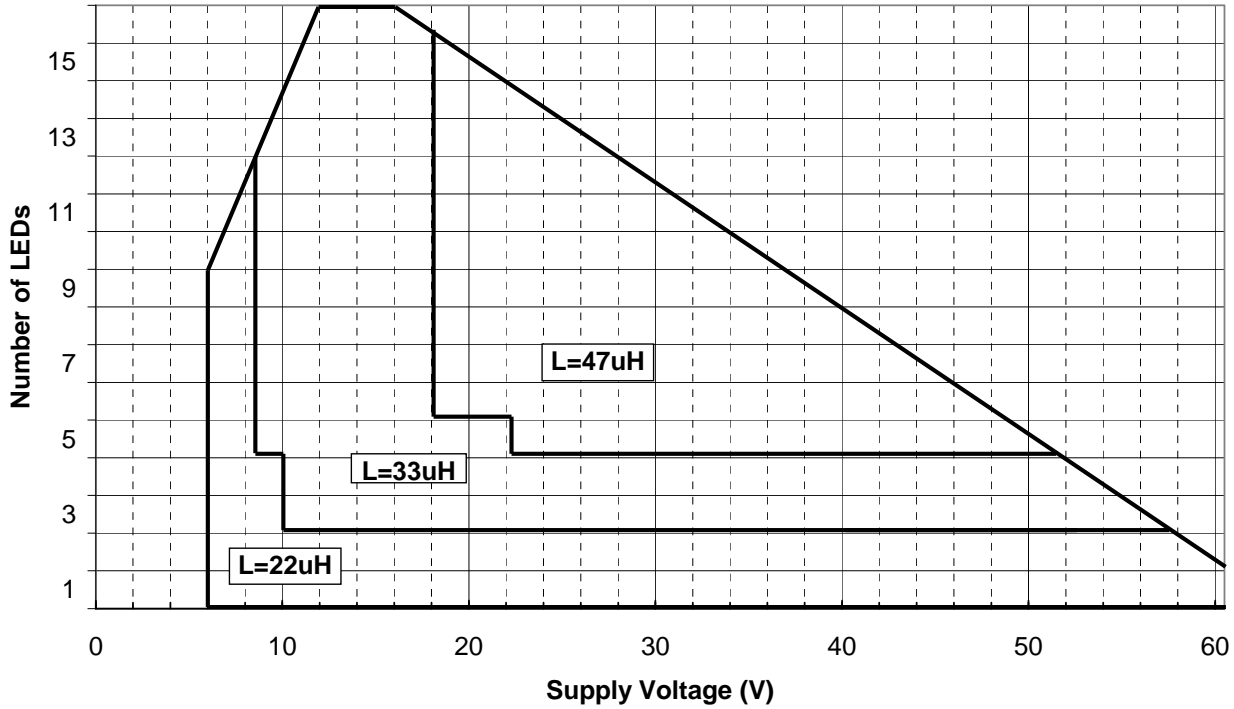

Figure 36: 350mA Buck-boost mode inductor selection for target frequency 400kHz

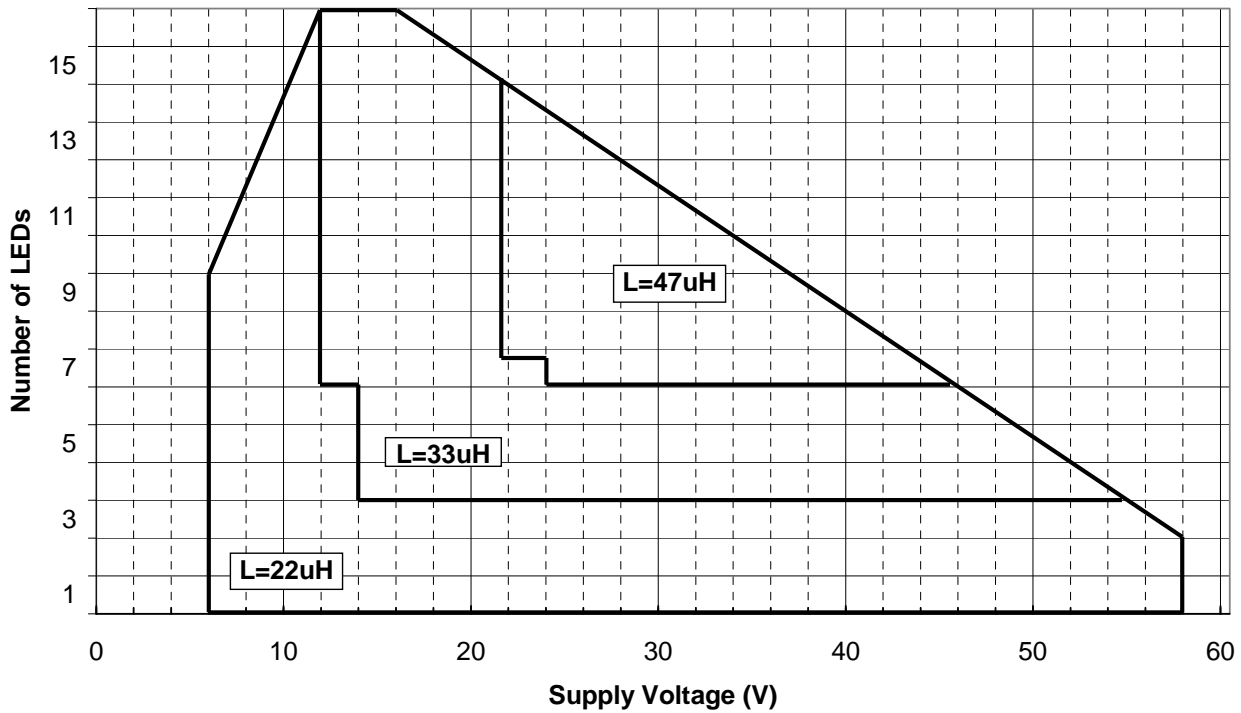

Figure 37: 350mA Buck-boost mode inductor selection for target frequency > 500kHz

NEW PRODUCT

Applications Information (Continued)

For example, in a Buck-boost configuration ($V_{IN} = 10\text{-}18\text{V}$ and 4 LEDs), with a load current of 350mA; if the target frequency is around 400kHz, the Ideal inductor size is $L = 33\mu\text{H}$. The same size of inductor can be used if the target frequency is higher than 500kHz driving 6LEDs with a current of 350mA from a $V_{IN} = 12\text{-}24\text{V}$.

In the case of the Boost topology, the following graphs guide the designer to select the inductor for a target frequency of 400kHz (figure 38) or higher than 500kHz (figure 39).

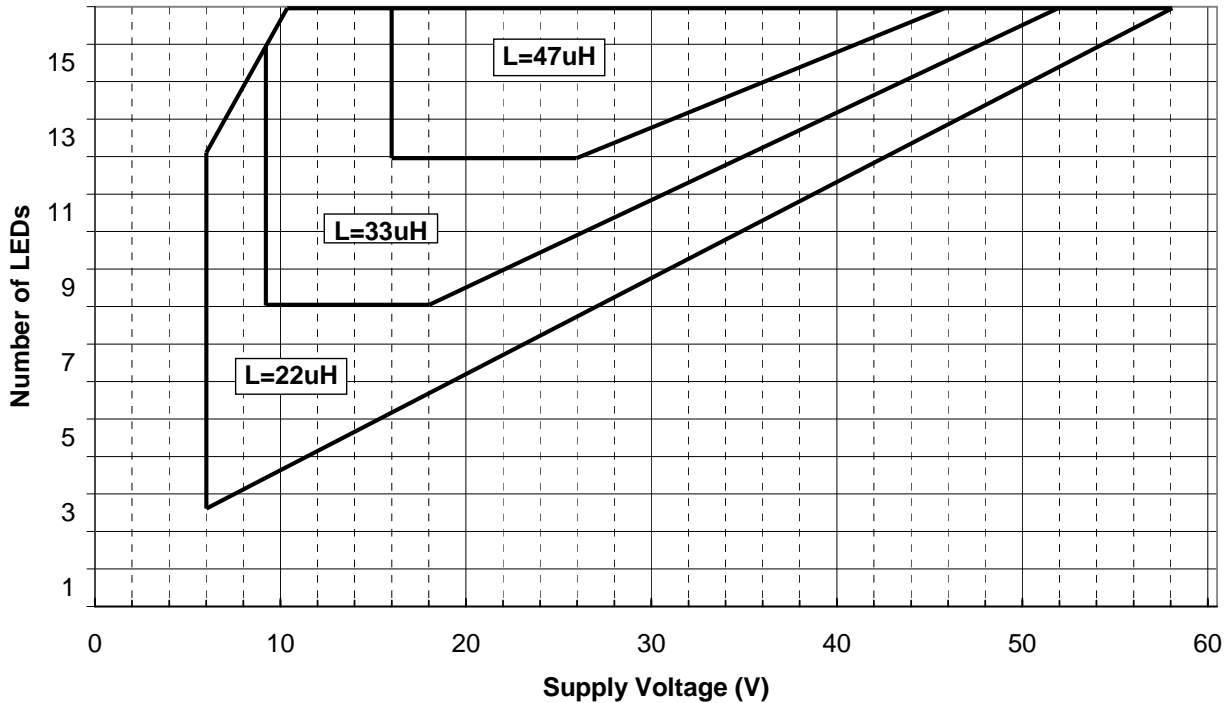

Figure 38: 350mA Boost mode inductor selection for target frequency 400kHz

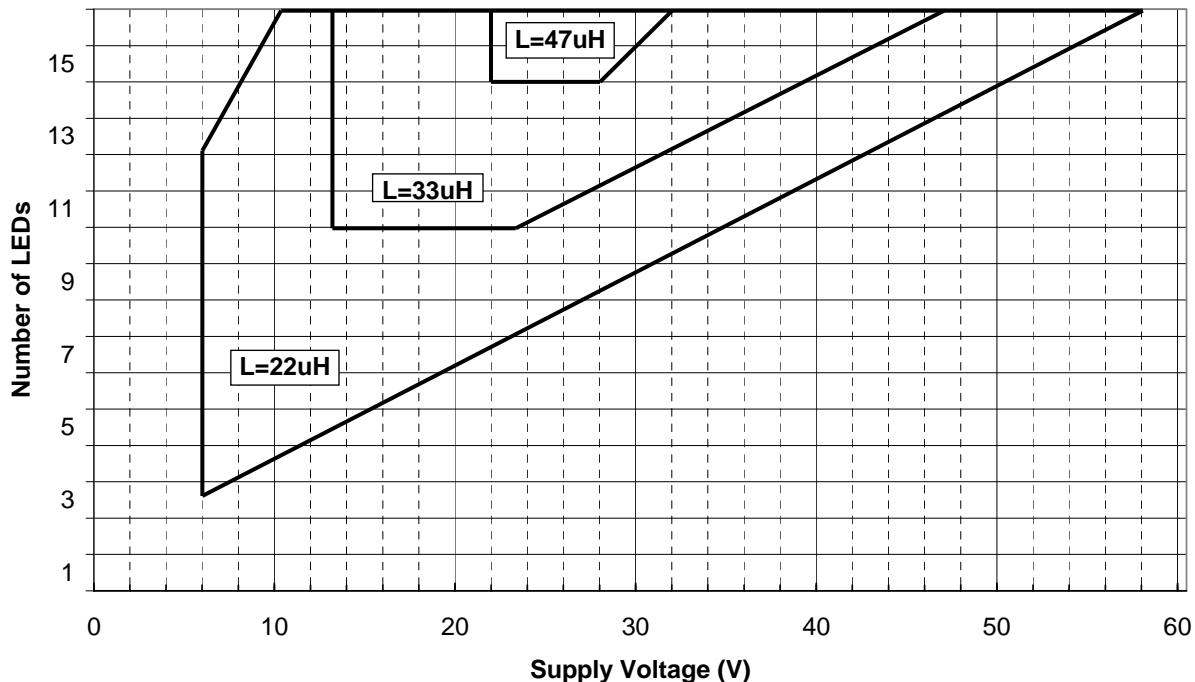

Figure 39: 350mA Boost mode inductor selection for target frequency > 500kHz

Applications Information (Continued)

Suitable coils for use with the ZXLD1374 may be selected from the MSS range manufactured by Coilcraft, or the NPIS range manufactured by NIC components.

The following websites may be useful in finding suitable components

www.coilcraft.com

www.niccomp.com

www.wuerth-elektronik.de

DIODE SELECTION

For maximum efficiency and performance, the rectifier (D1) should be a fast low capacitance Schottky diode* with low reverse leakage at the maximum operating voltage and temperature. The Schottky diode also provides better efficiency than silicon PN diodes, due to a combination of lower forward voltage and reduced recovery time.

It is important to select parts with a peak current rating above the peak coil current and a continuous current rating higher than the maximum output load current. In particular, it is recommended to have a voltage rating at least 15% higher than the maximum LX voltage to ensure safe operation during the ringing of the switch node and a current rating at least 10% higher than the average diode current. The power rating is verified by calculating the power loss through the diode.

The higher forward voltage and overshoot due to reverse recovery time in silicon diodes will increase the peak voltage on the LX pin. If a silicon diode is used, care should be taken to ensure that the total voltage appearing on the LX pin, including supply ripple, does not exceed the specified maximum value.

*A suitable Schottky diode would be PDS3100 (Diodes Inc).

OUTPUT CAPACITOR

An output capacitor may be required to limit interference or for specific EMC purposes. For Boost and Buck-boost regulators, the output capacitor provides energy to the load when the freewheeling diode is reverse biased during the first switching subinterval. An output capacitor in a Buck topology will simply reduce the LED current ripple below the inductor current ripple. In other words, this capacitor changes the current waveform through the LED(s) from a triangular ramp to a more sinusoidal version without altering the mean current value.

In all cases, the output capacitor is chosen to provide a desired current ripple of the LED current (usually recommended to be less than 40% of the average LED current).

Buck:

$$C_{\text{OUTPUT}} = \frac{\Delta I_{L-PP}}{8 \times f_{\text{SW}} \times r_{\text{LED}} \times \Delta I_{\text{LED-PP}}}$$

Boost and Buck-boost

$$C_{\text{OUTPUT}} = \frac{D \times I_{\text{LED}}}{f_{\text{SW}} \times r_{\text{LED}} \times \Delta I_{\text{LED-PP}}}$$

where:

- ΔI_L is the ripple of the inductor current, usually $\pm 20\%$ of the average sensed current
- ΔI_{LED} is the ripple of the LED current, it should be $<40\%$ of the LEDs average current
- f_{SW} is the switching frequency (from graphs and calculator)
- r_{LED} is the dynamic resistance of the LEDs string (n times the dynamic resistance of the single LED from the datasheet of the LED manufacturer).

The output capacitor should be chosen to account for derating due to temperature and operating voltage. It must also have the necessary RMS current rating. The minimum RMS current for the output capacitor is calculated as follows:

Buck

$$I_{\text{COUTPUT-RMS}} = \frac{I_{\text{LED-PP}}}{\sqrt{12}}$$

Applications Information (Continued)

Boost and Buck-boost

$$I_{\text{COUTPUT-RMS}} = I_{\text{LED}} \sqrt{\frac{D_{\text{MAX}}}{1 - D_{\text{MAX}}}}$$

Ceramic capacitors with X7R dielectric are the best choice due to their high ripple current rating, long lifetime, and performance over the voltage and temperature ranges.

BOOTSTRAP CIRCUIT

In Boost and Buck-boost modes with input voltages below 12V to fully enhance the internal power switch it is required to use a bootstrap network as shown in figure 40.

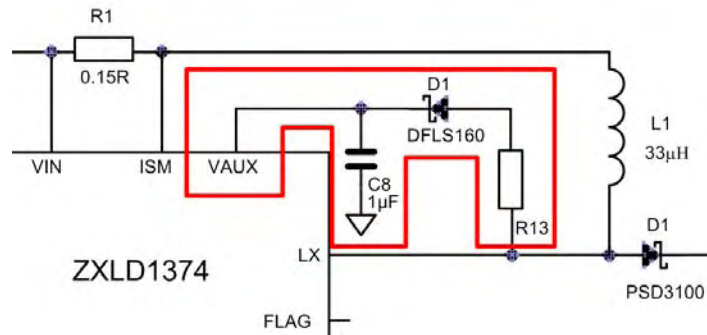

Figure 40: Bootstrap circuit for low voltage operations

The bootstrap circuit is realized by adding a reservoir capacitor, C8, current limiting resistor R13 (=100Ω) and a blocking diode D2 (DFSL160). During the power switch turn-on C8 needs to be able to supply approximately 10mA current.

A capacitor of 1uF (C8) provides a reasonable trade-off between VAUX supply needs and LED current accuracy. At start-up the VAUX pin requires only a few mA of current from the LED current. In normal operation the current taken from the LED current to supply VAUX will be negligible.

INPUT CAPACITOR

The input capacitor and minimum RMS current for the output capacitor can be calculated knowing the input voltage ripple $\Delta V_{\text{IN-PP}}$ as follows:

Input capacitor

Minimum RMS current

Buck

$$C_{\text{IN}} = \frac{D \times (1 - D) \times I_{\text{LED}}}{f_{\text{SW}} \times \Delta V_{\text{IN-PP}}}$$

$$I_{\text{CIN-RMS}} = I_{\text{LED}} \times \sqrt{D \times (1 - D)}$$

use D=0.5 as worst case

use D=0.5 as worst case

Boost

$$C_{\text{IN}} = \frac{\Delta I_{\text{COIL-PP}}}{8 \times f_{\text{SW}} \times \Delta V_{\text{IN-PP}}}$$

$$I_{\text{CIN-RMS}} = \frac{I_{\text{L-PP}}}{\sqrt{12}}$$

Buck-boost

$$C_{\text{IN}} = \frac{D \times I_{\text{LED}}}{f_{\text{SW}} \times \Delta V_{\text{IN-PP}}}$$

$$I_{\text{CIN-RMS}} = I_{\text{LED}} \times \sqrt{\frac{D}{(1 - D)}}$$

Use D = D_{MAX} as worst case

Use D = D_{MAX} as worst case

Applications Information (Continued)

PWM OUTPUT CURRENT CONTROL & DIMMING

The ZXLD1374 has a dedicated PWM dimming input that allows a wide dimming frequency range from 100Hz to 1kHz with 1000:1 resolution; however higher dimming frequencies can be used – at the expense of dimming dynamic range and accuracy.

Typically, for a PWM frequency of 1kHz, the error on the current linearity is lower than 5%; in particular the accuracy is better than 1% for PWM from 5% to 100%. This is shown in the graph below:

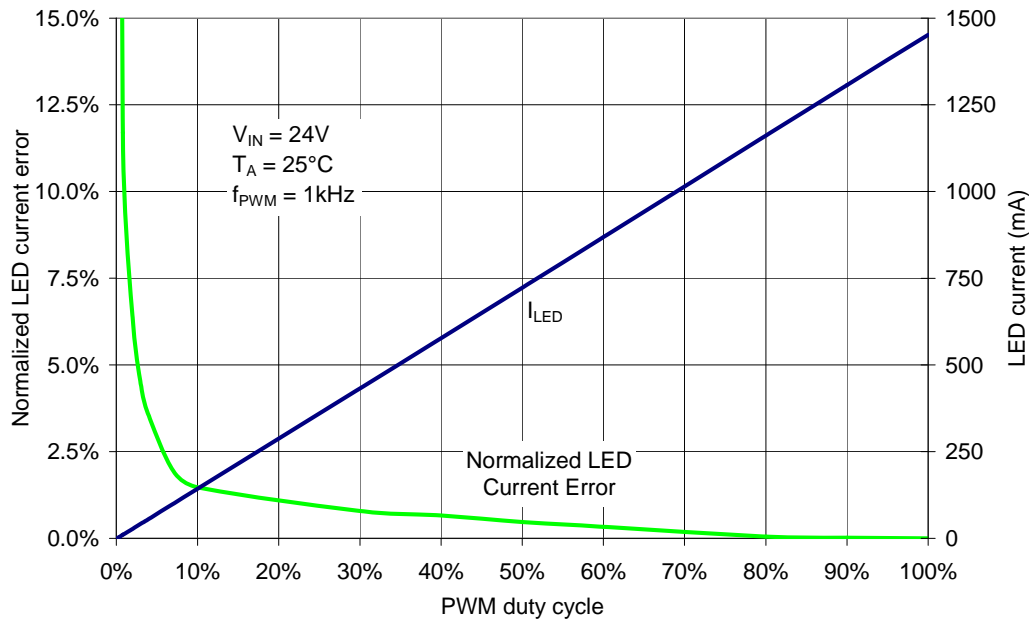

Figure 41. LED current linearity and accuracy with PWM dimming at 1kHz

For a PWM frequency of 100Hz, the error on the current linearity is lower than 2.5%; it becomes negligible for PWM greater than 5%. This is shown in the graph below:

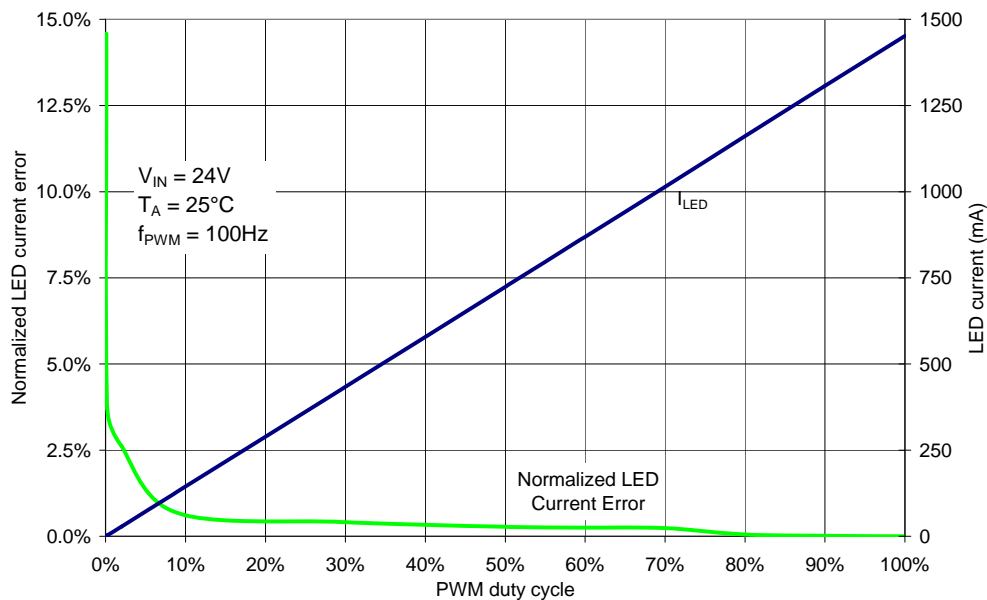

Figure 42. LED current linearity and accuracy with PWM dimming at 100Hz

Applications Information (Continued)

The PWM pin is designed to be driven by both 3.3V and 5V logic levels. It can be driven also by an open drain/collector transistor. In this case the designer can either use the internal pull-up network or an external pull-up network in order to speed-up PWM transitions, as shown in the Boost/ Buck-boost section.

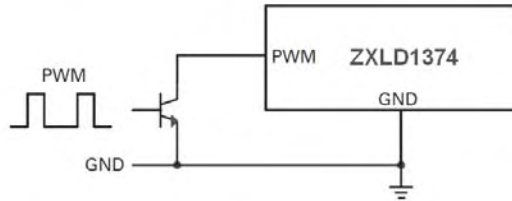

Figure 43. PWM Dimming from Open Collector Switch

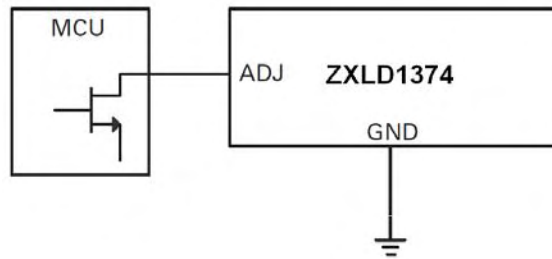

Figure 44. PWM Dimming from MCU

LED current can be adjusted digitally, by applying a low frequency PWM logic signal to the PWM pin to turn the controller on and off. This will produce an average output current proportional to the duty cycle of the control signal. During PWM operation, the device remains powered up and only the output switch is gated by the control signal.

The PWM signal can achieve very high LED current resolution. In fact, dimming down from 100% to 0, a minimum pulse width of 5 μ s can be achieved resulting in very high accuracy. While the maximum recommended pulse is for the PWM signal is 10ms.

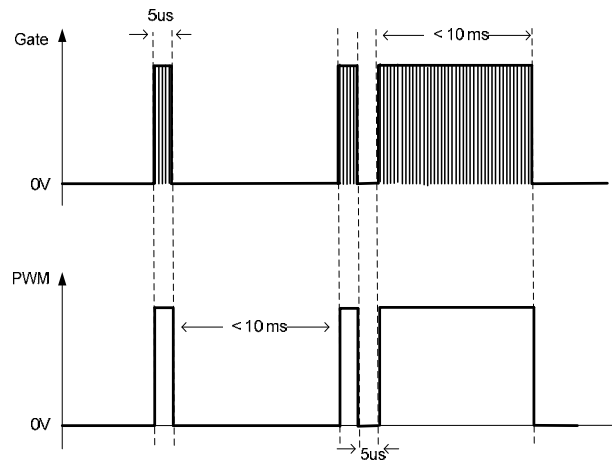

Figure 45. PWM Dimming Minimum and Maximum Pulse

Applications Information (Continued)

The device can be put in standby by taking the PWM pin to ground, or pulling it to a voltage below 0.4V with a suitable open collector NPN or open drain NMOS transistor, for a time exceeding 15ms (nominal). In the shutdown state, most of the circuitry inside the device is switched off and residual quiescent current will be typically 90µA. In particular, the Status pin will go down to GND while the FLAG and REF pins will stay at their nominal values.

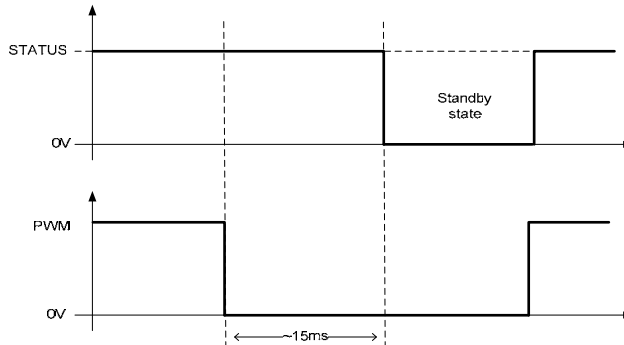

Fig 46. Stand-by state from PWM signal

TADJ pin - Thermal control of LED current

The 'Thermal control' circuit monitors the voltage on the TADJ pin and reduces output current if the voltage on this pin falls below 625mV. An external NTC thermistor and resistor can therefore be connected as shown below to set the voltage on the TADJ pin to 625mV at the required temperature threshold. This will give 100% LED current below the threshold temperature and a falling current above it as shown in the graph. The temperature threshold can be altered by adjusting the value of R_{th} and/or the thermistor to suit the requirements of the chosen LED.

The Thermal Control feature can be disabled by connecting T_{ADJ} to REF.

Here is a simple procedure to design the thermal feedback circuit:

1. Select the temperature threshold T_{THRESHOLD} at which the current must start to decrease
2. Select the Thermistor TH1 (both resistive value at 25°C and beta)
3. Select the value of the resistor R_{TH} as R_{TH} = TH1 at T_{THRESHOLD}

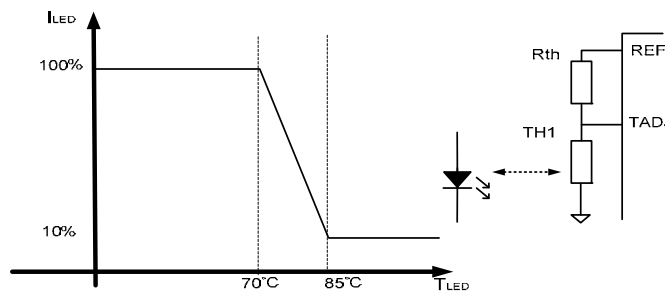

Thermal network response in Buck configuration with:
R_{th} = 2kΩ and TH1=10kΩ (beta=3900)

Figure 47. Thermal feedback network

For example,

- 1) Temperature threshold T_{THRESHOLD} = 70°C
- 2) TH1 = 10kΩ at 25°C and beta= 3500 → TH1 = 3.3kΩ at 70°C
- 3) R_{TH} = TH1 at T_{THRESHOLD} = 3.3kΩ

Applications Information (Continued)

Over-Temperature Shutdown

The ZXLD1374 incorporates an over-temperature shutdown circuit to protect against damage caused by excessive die temperature. A warning signal is generated on the STATUS output when die temperature exceeds 125°C nominal and the output is disabled when die temperature exceeds 150°C nominal. Normal operation resumes when the device cools back down to 125°C.

FLAG/STATUS Outputs

The FLAG/STATUS outputs provide a warning of extreme operating or fault conditions. FLAG is an open-drain logic output, which is normally high resistance, but switches low resistance to indicate that a warning, or fault condition exists. STATUS is a DAC output, which is normally high (4.5V), but switches to a lower voltage to indicate the nature of the warning/fault.

Conditions monitored, the method of detection and the nominal STATUS output voltage are given in the following table:

Table 2

Warning/Fault condition	Severity (Note 10)	Monitored parameters	FLAG	Nominal STATUS voltage
Normal operation			H	4.5
Supply under-voltage	1	$V_{AUX} < 5.6V$	L	4.5
	2	$V_{IN} < 5.6V$	L	3.6
Output current out of regulation (Note 11)	2	V_{SHP} outside normal voltage range	L	3.6
Driver stalled with switch 'on', or 'off' (Note 12)	2	t_{ON} , or $t_{OFF} > 100\mu s$	L	3.6
Switch over-voltage	3	LX voltage > 60V	L	2.7
Device temperature above maximum recommended operating value	4	$T_J > 125^\circ C$	L	1.8
Sense resistor current I_{RS} above specified maximum	5	$V_{SENSE} > 0.375V$	L	0.9
Average switch current greater than 1.5A	5	$I_{LX} > 1.5A$	L	0.9

- Notes:
10. Severity 1 denotes lowest severity.
 11. This warning will be indicated if the output power demand is higher than the available input power; the loop may not be able to maintain regulation.
 12. This warning will be indicated if the LX pin stays at the same level for greater than 100us (e.g. the internal transistor cannot pass enough current to reach the upper switching threshold).

Applications Information (Continued)

NEW PRODUCT

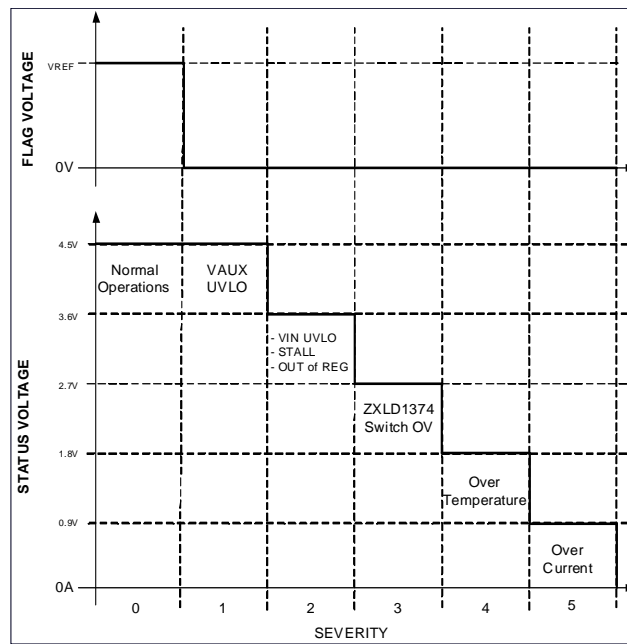

Fig 48. Status levels

In the event of more than one fault/warning condition occurring, the higher severity condition will take precedence. E.g. 'Excessive coil current' and 'Out of regulation' occurring together will produce an output of 0.9V on the STATUS pin.

If $V_{ADJ} > 1.7V$, V_{SENSE} may be greater than the excess coil current threshold in normal operation and an error will be reported. Hence, STATUS and FLAG are only guaranteed for $V_{ADJ} \leq V_{REF}$.

Diagnostic signals should be ignored during the device start – up for 100 μ s. The device start up sequence will be initiated both during the first power on of the device or after the PWM signal is kept low for more than 15ms, initiating the standby state of the device.

In particular, during the first 100 μ s the diagnostic is signaling an over-current then an out-of-regulation status. These two events are due to the charging of the inductor and are not true fault conditions.

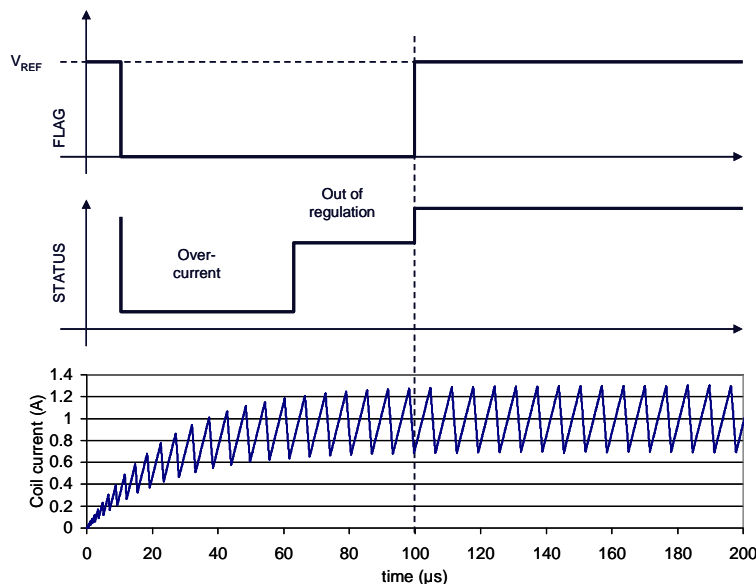

Figure 49. Diagnostic during Start-Up

Applications Information (Continued)

Over-voltage Protection

The ZXLD1374 is inherently protected against open-circuit load when used in Buck configuration. However care has to be taken with open-circuit load conditions in Buck-boost or Boost configurations. This is because in these configurations there is only an over-voltage FLAG but no internal open-circuit protection mechanism for the internal MOSFET. In this case an Over-Voltage-Protection (OVP) network should be provided to the MOSFET to avoid damage due to open circuit conditions. This is shown in **Figure 37** below, highlighted in the dotted blue box.

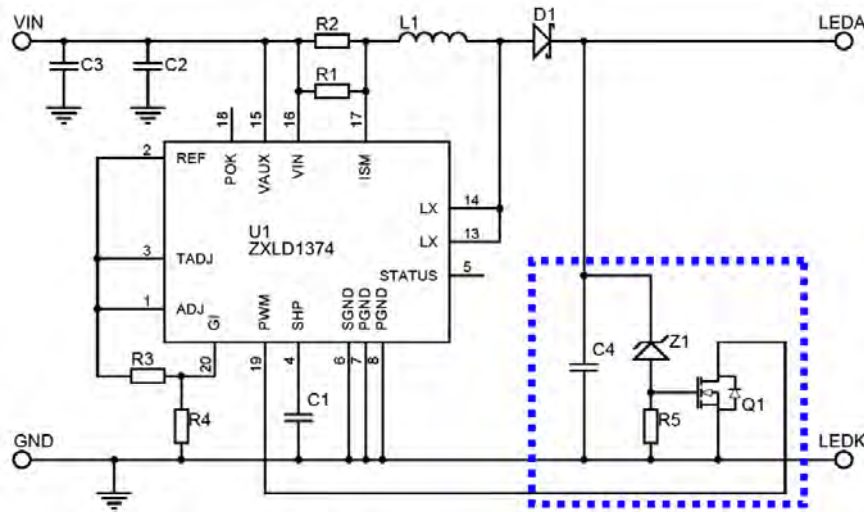

Figure 50. OVP Circuit

The zener voltage is determined according to: $V_z = V_{LED_{MAX}} + 10\%$. The LX pin voltage exceeds V_z then the gate of MOSFET Q2 will start to turn on causing the PWM pin to be brought low. This will disable the LX output until the voltage on the LX falls below V_z . If the fault exists for longer than 20ms then the ZXLD1374 will enter into a shutdown state.

Take care of the max voltage drop on the Q2 MOSFET gate.

Alternatively, to perform the OVP function, it can be used the diagnostic section of the ZXLD1374. In particular a microcontroller can read the FLAG and the status pins, and if they signal an over-voltage, the microcontroller can switch the device off by pulling the PWM signal low.

NEW PRODUCT

Applications Information (Continued)

PCB Layout considerations

PCB layout is a fundamental activity to get the most of the device in all configurations. In the following section it is possible to find some important insight to design with the ZXLD1374 both in Buck and Buck-boost/Boost configurations.

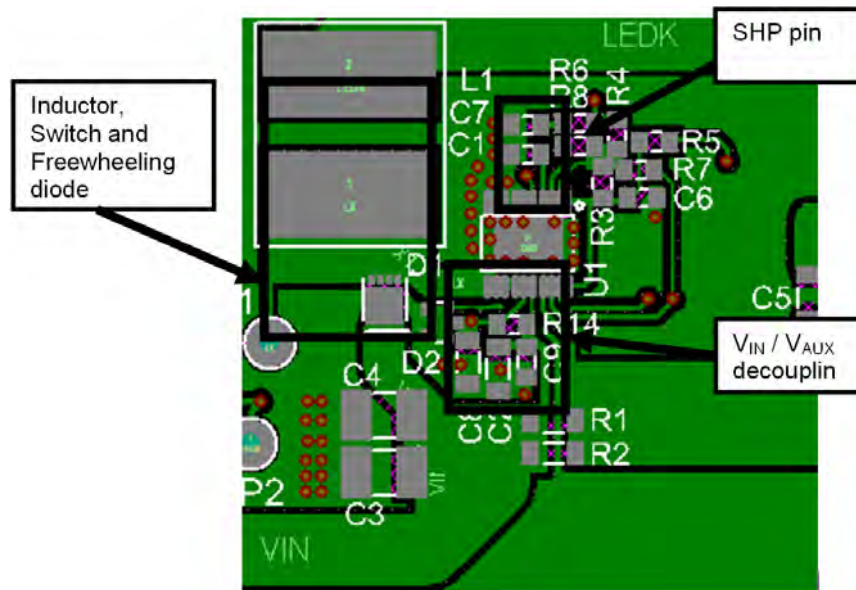

Figure 51. Circuit Layout

Here are some considerations useful for the PCB layout:

- In order to avoid ringing due to stray inductances, the inductor L1, the anode of D1 and the LX pin should be placed as close together as possible.
- The shaping capacitor C1 is fundamental for the stability of the control loop. To this end it should be placed no more than 5mm from the SHP pin.
- Input voltage pins, V_{IN} and V_{AUX} , need to be decoupled. It is recommended to use two ceramic capacitors of 2.2 μ F, X7R, 100V (C3 and C4). In addition to these capacitors, it is suggested to add two ceramic capacitors of 1 μ F, X7R, 100V each (C2, C8), as well as a further decoupling capacitor of 100nF close to the V_{IN}/V_{AUX} pins (C9) the device is used in Buck mode, or can be driven from a separate supply.

NEW PRODUCT

Applications Examples

1.5A Buck LED driver

In this application example, ZXLD1374 is connected as a Buck LED driver with schematic and parts list shown below. The LED driver is able to deliver 1.5A of LED current to single or multiple LEDs in series with input voltage ranged from 10V to 50V. In order to achieve high efficiency under high LED current, Super Barrier Rectifier (SBR) with low forward voltage is used as free wheeling rectifier.

With only a few extra components, the ZXLD1374 LED driver is able to deliver LED power of greater than 60W. This is suitable for applications which require high LED power likes high power down lighting, wall washer, automotive LED lighting etc.

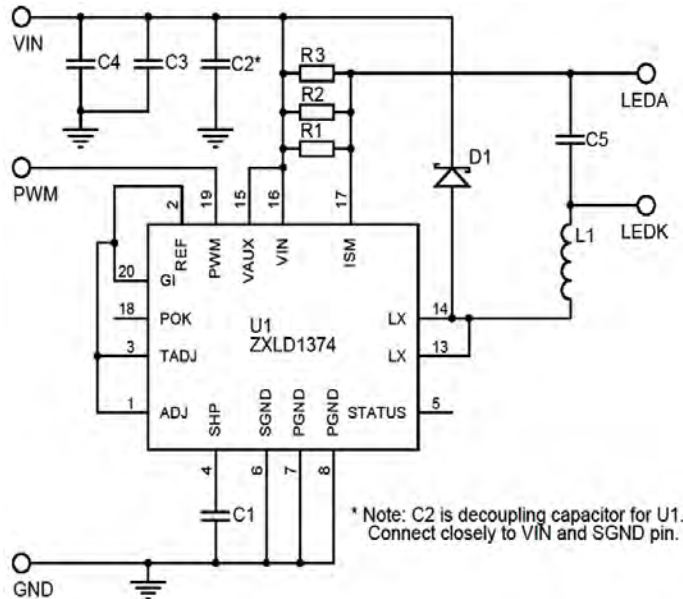

Figure 52. Application circuit of 1.5A Buck LED driver

Bill of Material

Ref No.	Value	Part No.	Manufacturer
U1	60V 1.5A LED driver	ZXLD1374	Diodes Inc
D1	100V 3A SBR	SBR3U100	Diodes Inc
L1	33uH 4.2A	744770933	Wurth Elektronik
C1	100pF 50V	SMD 0805/0603	Generic
C2	1uF 100V X7R	SMD1206	Generic
C3 C4 C5	2.2uF 100V X7R	SMD1210	Generic
R1 R2	300mΩ 1%	SMD1206	Generic
R3	4.7Ω	SMD1206	Generic

Typical Performance

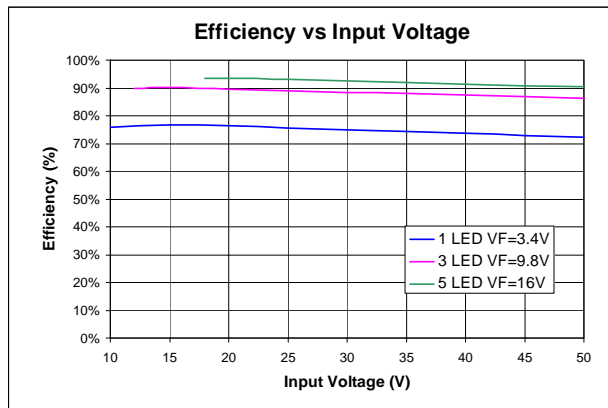

Figure 53. Efficiency

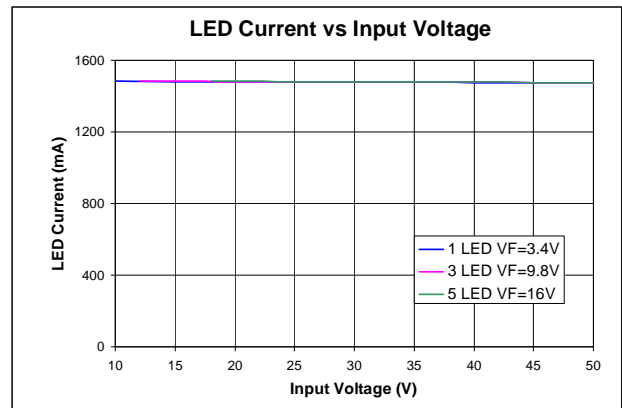

Figure 54. Line regulation

NEW PRODUCT

Applications Examples

350mA Boost LED driver

In this application example, ZXLD1374 is connected as a Boost LED driver with schematic and parts list shown below. The LED driver is able to deliver 350mA of LED current into 12 high brightness LED with input voltage ranged from 16V to 28V.

Overall high efficiency of 92%+ make it ideal for applications likes solar LED street lighting and general LED illuminations.

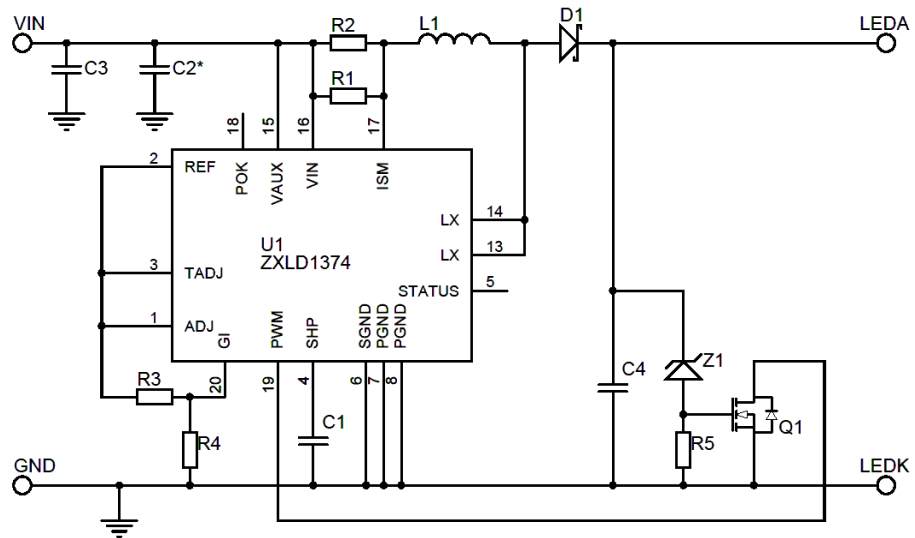

* Note: C2 is decoupling capacitor for U1. Connect closely to VIN and SGND pin.

Figure 55. Application circuit of 350mA Boost LED driver

Bill of Material

Ref No.	Value	Part No.	Manufacturer
U1	60V LED driver	ZXLD1374	Diodes Inc
Q1	60V MOSFET	2N7002A	Diodes Inc
D1	100V 3A Schottky	PDS3100-13	Diodes Inc
Z1	51V 410mW Zener	BZT52C51	Diodes Inc
L1	47uH 2.6A	744771147	Würth Elektronik
C1	100pF 50V	SMD 0805/0603	Generic
C3 C4	4.7uF 100V X7R	SMD1210	Generic
C2	1uF 50V X7R	SMD1206	Generic
R1 R2	300mΩ 1%	SMD1206	Generic
R3	120kΩ 1%	SMD 0805/0603	Generic
R4	36kΩ 1%	SMD 0805/0603	Generic
R5	2.7kΩ	SMD 0805/0603	Generic

Typical Performance

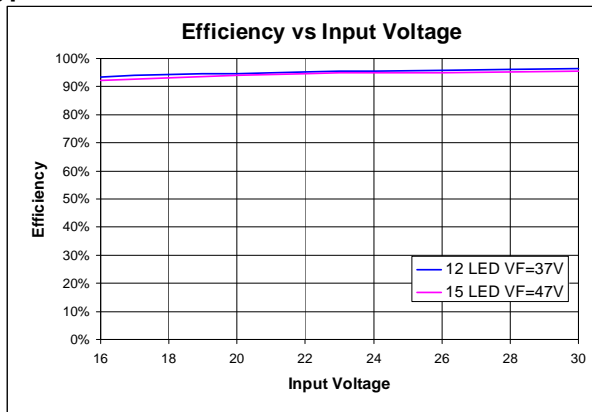

Figure 56. Efficiency

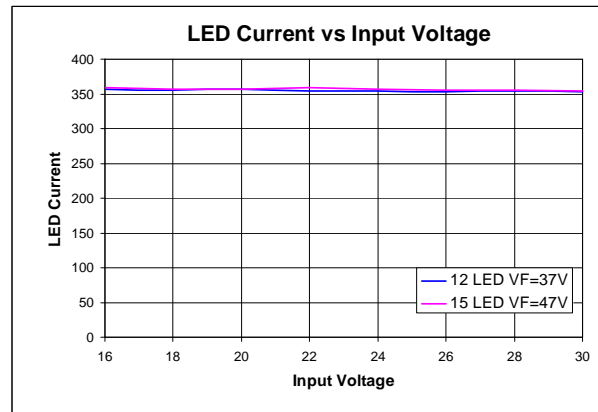

Figure 57. Line regulation

Applications Examples

350mA Buck-boost LED driver

In this application example, ZXLD1374 is connected as a Buck-boost LED driver with schematic and parts list shown below. The LED driver is able to deliver 350mA of LED current into 4/5 high brightness LED with input voltage ranged from 7V to 20V. In order to increase the driving voltage level for the internal MOSFET during low voltage input, bootstrap circuit formed by R6 D2 and C6 are used to supply higher voltage to the VAUX pin.

Since the Buck-boost LED driver can handle an input voltage range below and above the LED voltage, this versatile input voltage range makes it ideal for automotive lighting applications.

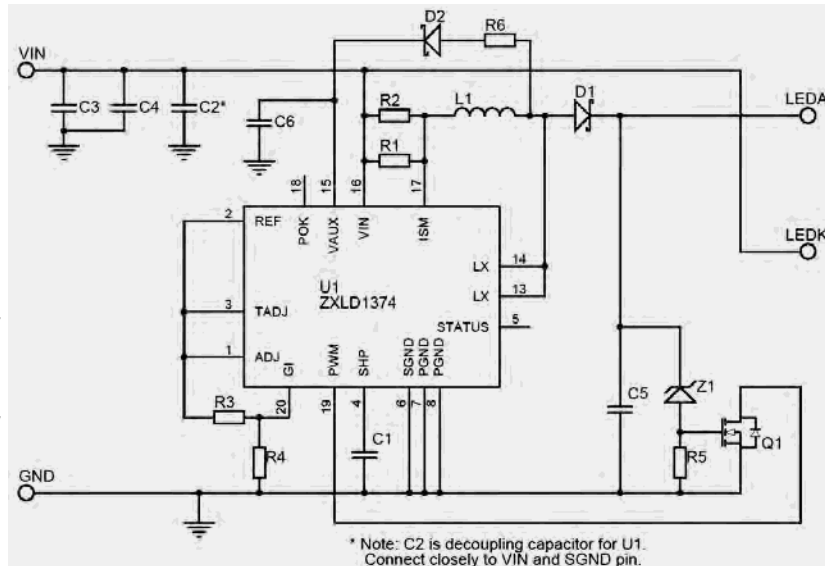

* Note: C2 is decoupling capacitor for U1. Connect closely to VIN and SGND pin.

Figure 58. Application circuit of 350mA Buck-boost LED driver

Bill of Material

Ref No.	Value	Part No.	Manufacturer
U1	60V LED driver	ZXLD1374	Diodes Inc
Q1	60V MOSFET	2N7002A	Diodes Inc
D1	100V 3A Schottky	PDS3100-13	Diodes Inc
D2	100V 1A Schottky	B1100	Diodes Inc
Z1	47V 410mW Zener	BZT52C47	Diodes Inc
L1	47uH 2.6A	744771147	Würth Elektronik
C1	100pF 50V	SMD 0805/0603	Generic
C3 C4 C5	4.7uF 50V X7R	SMD1210	Generic
C2 C6	1uF 50V X7R	SMD1206	Generic
R1 R2	300mΩ 1%	SMD1206	Generic
R3	120kΩ 1%	SMD 0805/0603	Generic
R4	36kΩ 1%	SMD 0805/0603	Generic
R5	2.7kΩ	SMD 0805/0603	Generic
R6	1kΩ	SMD 1206	Generic

Typical Performance

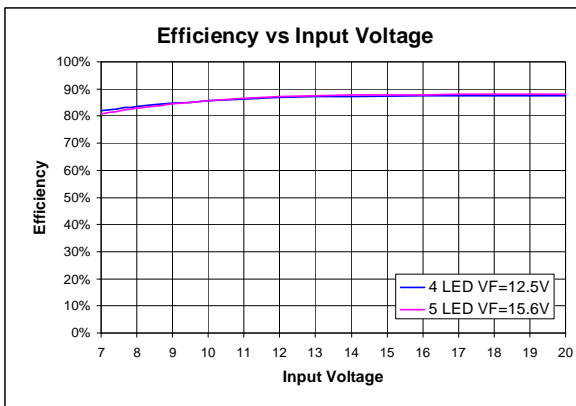

Figure 59. Efficiency

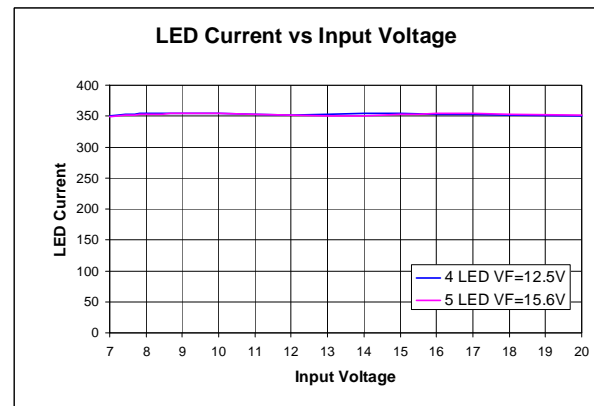

Figure 60. Line regulation

NEW PRODUCT

Ordering Information

Device	Packaging	Status	Part Marking	Reel Quantity	Tape Width	Reel Size
ZXLD1374EST20TC	TSSOP-20EP	Active	ZXLD1374	2500	16mm	13"

Package Mechanical Data

TSSOP-20 EP

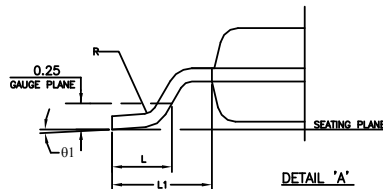
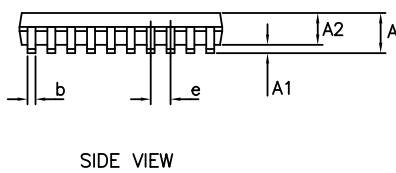
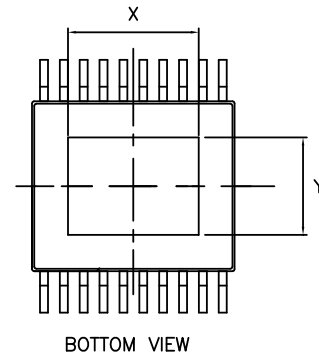
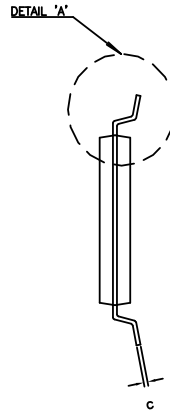
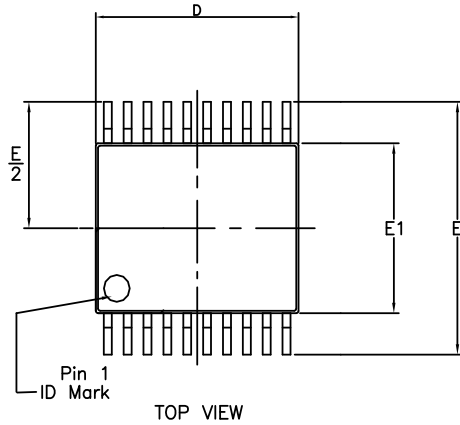

MILLIMETRES			
DIM	MIN	MAX	TYP
A	—	1.20	—
A1	0.025	0.1	—
A2	0.80	1.05	0.90
b	0.19	0.30	—
c	0.09	0.20	—
D	6.4	6.6	6.5
E1	4.3	4.5	4.4
E	6.2	6.6	6.4
e	—	—	0.65
L	0.45	0.75	0.60
L1	1.0		REF
X	—	—	4.191
Y	—	—	2.997
R1	0.09	—	—

NOTES:
1. ALL DIMENSION ARE IN MILLIMETERS.

NEW PRODUCT

IMPORTANT NOTICE

DIODES INCORPORATED MAKES NO WARRANTY OF ANY KIND, EXPRESS OR IMPLIED, WITH REGARDS TO THIS DOCUMENT, INCLUDING, BUT NOT LIMITED TO, THE IMPLIED WARRANTIES OF MERCHANTABILITY AND FITNESS FOR A PARTICULAR PURPOSE (AND THEIR EQUIVALENTS UNDER THE LAWS OF ANY JURISDICTION).

Diodes Incorporated and its subsidiaries reserve the right to make modifications, enhancements, improvements, corrections or other changes without further notice to this document and any product described herein. Diodes Incorporated does not assume any liability arising out of the application or use of this document or any product described herein; neither does Diodes Incorporated convey any license under its patent or trademark rights, nor the rights of others. Any Customer or user of this document or products described herein in such applications shall assume all risks of such use and will agree to hold Diodes Incorporated and all the companies whose products are represented on Diodes Incorporated website, harmless against all damages.

Diodes Incorporated does not warrant or accept any liability whatsoever in respect of any products purchased through unauthorized sales channel.

Should Customers purchase or use Diodes Incorporated products for any unintended or unauthorized application, Customers shall indemnify and hold Diodes Incorporated and its representatives harmless against all claims, damages, expenses, and attorney fees arising out of, directly or indirectly, any claim of personal injury or death associated with such unintended or unauthorized application.

Products described herein may be covered by one or more United States, international or foreign patents pending. Product names and markings noted herein may also be covered by one or more United States, international or foreign trademarks.

LIFE SUPPORT

Diodes Incorporated products are specifically not authorized for use as critical components in life support devices or systems without the express written approval of the Chief Executive Officer of Diodes Incorporated. As used herein:

A. Life support devices or systems are devices or systems which:

1. are intended to implant into the body, or
2. support or sustain life and whose failure to perform when properly used in accordance with instructions for use provided in the labeling can be reasonably expected to result in significant injury to the user.

B. A critical component is any component in a life support device or system whose failure to perform can be reasonably expected to cause the failure of the life support device or to affect its safety or effectiveness.

Customers represent that they have all necessary expertise in the safety and regulatory ramifications of their life support devices or systems, and acknowledge and agree that they are solely responsible for all legal, regulatory and safety-related requirements concerning their products and any use of Diodes Incorporated products in such safety-critical, life support devices or systems, notwithstanding any devices- or systems-related information or support that may be provided by Diodes Incorporated. Further, Customers must fully indemnify Diodes Incorporated and its representatives against any damages arising out of the use of Diodes Incorporated products in such safety-critical, life support devices or systems.

Copyright © 2010, Diodes Incorporated

www.diodes.com