



ROV Metal Oxide Varistors

ROV metal oxide varistors help protect power systems from damage caused by transient overvoltage faults such as lightning, power contact, and power induction. Suitable for a broad range of applications, ROV devices help protect sensitive electronic equipment from potential power surge damage by clamping high-energy, short-duration impulses.

The ROV's high current handling and energy absorption capability, fast response and low cost make it suitable for overvoltage protection in telecom, datacom and security systems, surge strips, power supplies, control board transformers and electric motors. ROVs can also be used to help protect electrical equipment from damage caused by large voltage or power transients on the AC Mains inputs. In a coordinated circuit protection scheme the ROV can be paired with a PolySwitch overcurrent protection device to help improve equipment reliability and fulfill IEC-61000 test requirements.



Benefits

- Helps provide overvoltage fault protection for a wide variety of power systems
- Helps designers meet UL, CSA, and VDE standards
- Helps reduce warranty and service costs
- Low cost (\$/Joule)

Features

- RoHS compliant
- Various diameter sizes: 5mm, 7mm, 10mm, 14mm, 20mm
- Broad varistor voltage range: 18V - 1800V
- Various surge capabilities: standard, high surge, extra high surge
- High current handling and energy absorption capability
- Fast response time
- Low leakage current
- Various lead types: straight, kinked, other special lead types
- Various packaging options: bulk, tape and reel, ammo pack

Applications

- Power systems
- Surge strips
- Security systems
- Motors
- Telecommunications equipment
- Automotive electrical systems
- Household appliances

Table V1 ROV Metal Oxide Varistors Quick Selection Guide
Standard Series ROV Devices

Varistor Voltage	V _{RMS AC}	Maximum Surge Current (8 x 20µs)	Rated Wattage	Energy (10 x 1000µs)	Possible Varistor Reference
18-68V	11-40V	≤100A	≤0.01W	0.6 – 2.1J	5mm series: 180M - 680K
		≤250A	≤0.02W	1.2 – 4.3J	7mm series: 180M - 680K
		≤500A	≤0.05W	2.4 – 8.5J	10mm series: 180M - 680K
		≤1000A	≤0.10W	4.7 – 17.0J	14mm series: 180M - 680K
		≤2000A	≤0.20W	7.0 – 24.0J	20mm series: 180M - 680L
82-750V	50-460V	≤400A	≤0.10W	2.8 – 22.5J	5mm series: 820K - 751K
82-820V	50-510V	≤1200A	≤0.25W	5.5 – 47.0J	7mm series: 820K - 821K
82-1800V	50-1000V	≤2500A	≤0.40W	11.0 – 174.0J	10mm series: 820K - 182K
		≤4500A	≤0.60W	22.0 – 348.0J	14mm series: 820K - 182K
		≤6500A	≤1.00W	44.0 – 695.0J	20mm series: 820K - 182K

High Surge Series (H Series) ROV Devices

Varistor Voltage	V _{RMS AC}	Maximum Surge Current (8 x 20µs)	Rated Wattage	Energy (10 x 1000µs)	Possible Varistor Reference
18-68V	11-40V	≤250A	≤0.01W	0.7 – 2.6J	5mm series: H180M - H680K
		≤500A	≤0.02W	1.5 – 5.4J	7mm series: H180M - H680K
		≤1000A	≤0.05W	2.6 – 9.8J	10mm series: H180M - H680K
		≤2000A	≤0.10W	5.2 – 20.0J	14mm series: H180M - H680K
		≤3000A	≤0.20W	13.0 – 49.0J	20mm series: H180M - H680L
82-750V	50-460V	≤800A	≤0.10W	3.5 – 29.0J	5mm series: H820K - H751K
82-820V	50-510V	≤1750A	≤0.25W	7.0 – 60.0J	7mm series: H820K - H821K
82-1800V	50-1000V	≤3500A	≤0.40W	14.0 – 155.0J	10mm series: H820K - H182K
		≤6000A	≤0.60W	28.0 – 310.0J	14mm series: H820K - H182K
		≤10000A	≤1.00W	56.0 – 1020.0J	20mm series: H820K - H182K

Extra High Surge Series (E Series) ROV Devices

Varistor Voltage	V _{RMS AC}	Maximum Surge Current (8 x 20µs)	Rated Wattage	Energy (10 x 1000µs)	Possible Varistor Reference
200-360V	130-230V	≤6500A	≤0.60W	84.0 – 151.0J	14mm series: E201K - E361K
		≤12500A	≤1.00W	168.0 – 302.0J	20mm series: E201K - E361K

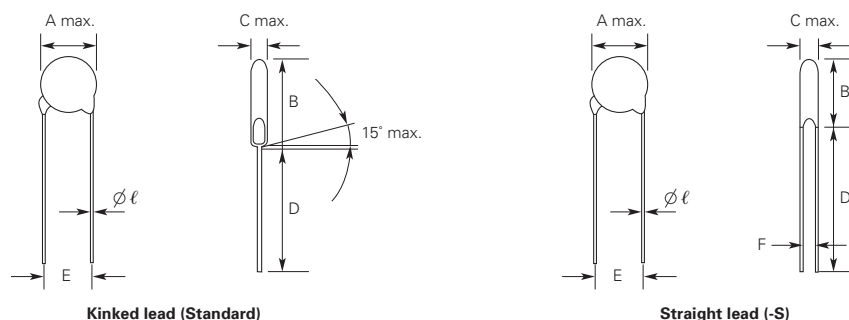
Figure V1 Dimension Figures for ROV Metal Oxide Varistors

Table V2 Dimensions in Millimeters for ROV Metal Oxide Varistors

Diameter	5mm	7mm	10mm	14mm	20mm
A max.	7.5	9.0	12.5	16.5	23.0
ℓ ± 0.05	0.6	0.6	0.8	0.8	1.0
E ± 1.0	5.0	5.0	7.5	7.5	10.0
B max.	11.0	13.0	18.0	22.0	28.0
D ₁ min.	25.0	25.0	25.0	25.0	25.0
D min.	24.0	24.0	24.0	24.0	24.0

Table V2 Dimensions in Millimeters for ROV Metal Oxide Varistors

... Cont'd

C Max. F & B, Max.

Diameter Type No.	5mm			7mm			10mm			14mm			20mm		
	C max.	F±0.8	B ₁ max.	C max.	F±0.8	B ₁ max.	C max.	F±0.8	B ₁ max.	C max.	F±0.8	B ₁ max.	C max.	F±0.8	B ₁ max.
180M	4.5	0.8	10.5	4.5	0.8	12.0	4.9	0.8	15.5	5.0	0.9	19.5	5.2	0.9	26.5
220L	4.5	0.9	10.5	4.5	0.9	12.0	4.9	0.9	15.5	5.0	1.0	19.5	5.3	1.0	26.5
270K	4.7	0.9	10.5	4.7	0.9	12.0	5.1	0.9	15.5	5.2	1.1	19.5	5.4	1.1	26.5
330K	4.7	1.0	10.5	4.7	1.0	12.0	5.1	1.0	15.5	5.2	1.2	19.5	5.4	1.2	26.5
390K	4.7	1.2	10.5	4.7	1.2	12.0	5.1	1.2	15.5	5.2	1.4	19.5	5.4	1.4	26.5
470K	5.0	1.2	10.5	5.0	1.2	12.0	5.5	1.2	15.5	5.6	1.4	19.5	5.6	1.4	26.5
560K	5.0	1.4	10.5	5.0	1.4	12.0	5.5	1.4	15.5	5.6	1.6	19.5	5.6	1.6	26.5
680K	5.5	1.7	10.5	5.5	1.7	12.0	6.0	1.7	15.5	6.1	1.9	19.5	6.1	1.9	26.5
820K	3.8	0.8	10.5	3.8	0.8	12.0	4.3	0.8	15.5	4.4	1.0	19.5	4.9	1.2	26.5
101K	3.9	0.8	10.5	3.9	0.8	12.0	4.4	0.8	15.5	4.5	1.0	19.5	5.1	1.2	26.5
121K	4.1	0.9	10.5	4.1	0.9	12.0	4.5	0.9	15.5	4.6	1.1	19.5	5.3	1.3	26.5
151K	4.5	1.2	10.5	4.5	1.2	12.0	4.9	1.2	15.5	5.1	1.4	19.5	5.6	1.6	26.5
181K	4.1	1.0	10.5	4.1	1.0	12.0	4.5	1.0	15.5	4.7	1.2	19.5	5.2	1.4	26.5
201K	4.2	1.0	10.5	4.2	1.0	12.0	4.6	1.0	15.5	4.8	1.2	19.5	5.3	1.4	26.5
221K	4.3	1.1	10.5	4.3	1.1	12.0	4.7	1.1	15.5	4.9	1.3	19.5	5.4	1.5	26.5
241K	4.4	1.1	10.5	4.4	1.3	12.0	4.8	1.3	15.5	5.0	1.5	19.5	5.5	1.7	26.5
271K	4.6	1.3	10.5	4.6	1.4	12.0	5.0	1.4	15.5	5.2	1.5	19.5	5.7	1.9	26.5
301K	4.8	1.3	10.5	4.8	1.5	12.0	5.2	1.6	15.5	5.4	1.7	19.5	5.9	2.1	26.5
331K	4.9	1.3	10.5	4.9	1.5	12.0	5.3	1.6	15.5	5.5	1.7	19.5	6.0	2.1	26.5
361K	5.1	1.8	10.5	5.1	1.9	12.0	5.5	1.9	15.5	5.7	2.1	19.5	6.2	2.3	26.5
391K	5.3	2.0	11.0	5.3	2.0	12.5	5.7	2.2	16.0	5.9	2.2	20.0	6.4	2.4	26.5
431K	6.1	2.1	11.0	6.1	2.0	12.5	6.5	2.5	16.0	6.7	2.5	20.0	7.2	2.7	26.5
471K	6.4	2.2	11.0	6.4	2.3	12.5	6.8	2.6	16.0	7.0	2.7	20.0	7.5	2.9	27.0
511K	6.6	2.5	11.5	6.6	2.5	13.0	7.0	3.1	16.5	7.2	3.1	20.5	7.7	3.3	27.0
561K	6.9	2.8	11.5	6.9	2.8	13.0	7.3	3.4	16.5	7.5	3.4	20.5	8.0	3.6	27.0
621K	7.2	3.1	11.5	7.2	3.1	13.0	7.6	4.0	16.5	7.8	3.8	20.5	8.3	4.1	27.0
681K	7.5	3.4	11.5	7.5	3.4	13.0	8.0	4.4	16.5	8.2	4.1	20.5	8.7	4.4	27.0
751K	7.9	3.7	11.5	7.9	3.7	13.0	8.4	4.4	16.5	8.6	4.3	20.5	9.1	4.5	27.0
781K	—	—	—	8.1	3.9	13.0	8.6	4.6	16.5	8.8	4.6	20.5	9.3	4.8	27.0
821K	—	—	—	8.3	4.1	13.0	8.8	4.6	16.5	9.0	4.6	20.5	9.5	4.8	27.0
911K	—	—	—	—	—	—	9.4	5.4	16.5	9.6	5.4	20.5	10.1	5.7	27.0
102K	—	—	—	—	—	—	9.9	5.4	16.5	10.1	5.6	20.5	10.7	5.8	27.0
112K	—	—	—	—	—	—	10.5	5.7	16.5	10.7	6.1	20.5	11.2	6.3	27.0
182K	—	—	—	—	—	—	12.6	9.8	18.5	12.8	10.2	22.5	13.5	10.4	29.0

Figure V2 Special Lead Configurations for ROV Metal Oxide Varistors

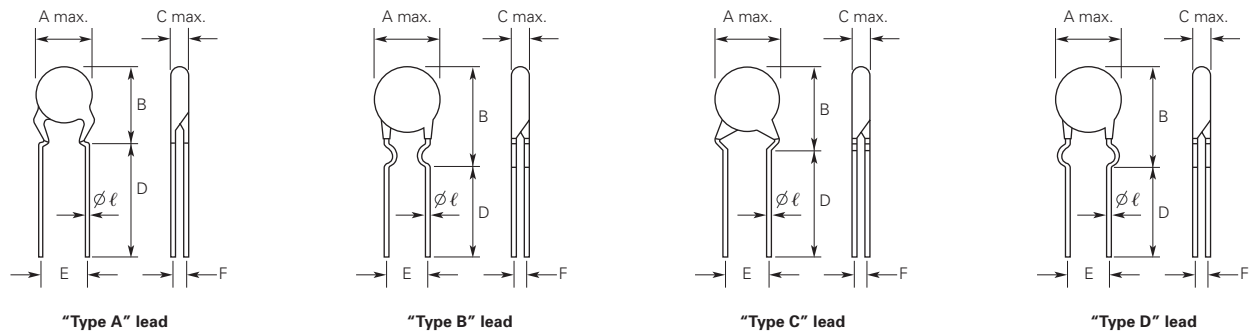

Table V3 Dimensions in Millimeters* for ROV Metal Oxide Varistors

Lead Type	Diameter	5mm	7mm	10mm	14mm	20mm
A, C	B max.	10.0	12.0	15.0	19.0	26.0
B, D	B max.	12.0	14.0	17.0	21.0	28.0

* All other dimensions are the same as those of the (standard) kinked leads.

Table V4 Rating and Characteristics for Standard Series Specifications — 5mm Devices

Part Number	Varistor Voltage V@0.1mA		Maximum Allowance Voltage		Maximum Clamping Voltage	Maximum Surge Current (8x20µs)		Rated Woltage	Energy (10x1000µs)	Capacitance (Typical)	Certification†
	DC (V)	Tolerance	AC (V _{RMS})	DC (V)	V@5A (V)	1 Time (A)	2 Times (A)	(W)	(J)	(pF)	
ROV05-180M	18	±20%	11	14	40*	100	50	0.01	0.6	1121	● ■
ROV05-220L	22	±15%	14	18	48*	100	50	0.01	0.7	1233	● ■
ROV05-270K	27	±10%	17	22	60*	100	50	0.01	0.9	1073	● ■
ROV05-330K	33	±10%	20	26	73*	100	50	0.01	1.1	834	● ■
ROV05-390K	39	±10%	25	31	86*	100	50	0.01	1.2	877	● ■
ROV05-470K	47	±10%	30	38	104*	100	50	0.01	1.5	715	● ■
ROV05-560K	56	±10%	35	45	123*	100	50	0.01	1.8	643	● ■
ROV05-680K	68	±10%	40	56	150*	100	50	0.01	2.1	501	● ■
ROV05-820K	82	±10%	50	65	145	400	200	0.10	2.8	269	● ■
ROV05-101K	100	±10%	60	85	175	400	200	0.10	3.5	263	● ■
ROV05-121K	120	±10%	75	100	210	400	200	0.10	4.0	180	● ■
ROV05-151K	150	±10%	95	125	260	400	200	0.10	5.5	180	● ■
ROV05-181K	180	±10%	115	150	320	400	200	0.10	6.5	95	● ■
ROV05-201K	200	±10%	130	170	355	400	200	0.10	7.1	85	◆ ● ▲ ■
ROV05-221K	220	±10%	140	180	380	400	200	0.10	7.8	80	◆ ● ▲ ■
ROV05-241K	240	±10%	150	200	415	400	200	0.10	8.4	74	◆ ● ▲ ■
ROV05-271K	270	±10%	175	225	475	400	200	0.10	9.9	69	◆ ● ▲ ■
ROV05-301K	300	±10%	195	250	525	400	200	0.10	10.5	65	◆ ● ▲ ■
ROV05-331K	330	±10%	210	275	575	400	200	0.10	11.5	60	◆ ● ▲ ■
ROV05-361K	360	±10%	230	300	620	400	200	0.10	13.0	69	◆ ● ▲ ■
ROV05-391K	390	±10%	250	320	675	400	200	0.10	15.0	56	◆ ● ▲ ■
ROV05-431K	430	±10%	275	350	745	400	200	0.10	16.5	47	◆ ● ▲ ■
ROV05-471K	470	±10%	300	385	810	400	200	0.10	17.5	50	◆ ● ▲ ■
ROV05-511K	510	±10%	320	418	880	400	200	0.10	18.5	50	◆ ● ▲ ■
ROV05-561K	560	±10%	350	460	940	400	200	0.10	19.5	50	◆ ● ▲ ■
ROV05-621K	620	±10%	385	505	1050	400	200	0.10	20.5	50	◆ ● ▲ ■
ROV05-681K	680	±10%	420	560	1150	400	200	0.10	21.5	43	◆ ● ▲ ■
ROV05-751K	750	±10%	460	615	1290	400	200	0.10	22.5	—	◆ ● ▲ ■

*The clamping voltages from 180M to 680K are tested at 1A current.

†Certification

Standard	UL1414‡	UL1449 (2nd Edition)‡	CSA	VDE
Title	Across-the-Line Components	Transient Voltage Surge Suppressors	Accessories and Parts for Electronic Equipment	Varistors for Use in Electronic Equipment
Symbols	◆	●	▲	■
File Number	E223034	E223033	220978	40006997

‡ For UL 1449 (2nd Edition), the maximum clamping voltage is measured at 500A.

Figure V3-V4 Standard Series Specifications — 5mm Devices
Pulse Lifetime Ratings and V-I Characteristic Curves

Figure V3 - ROV05-180M-ROV05-680K

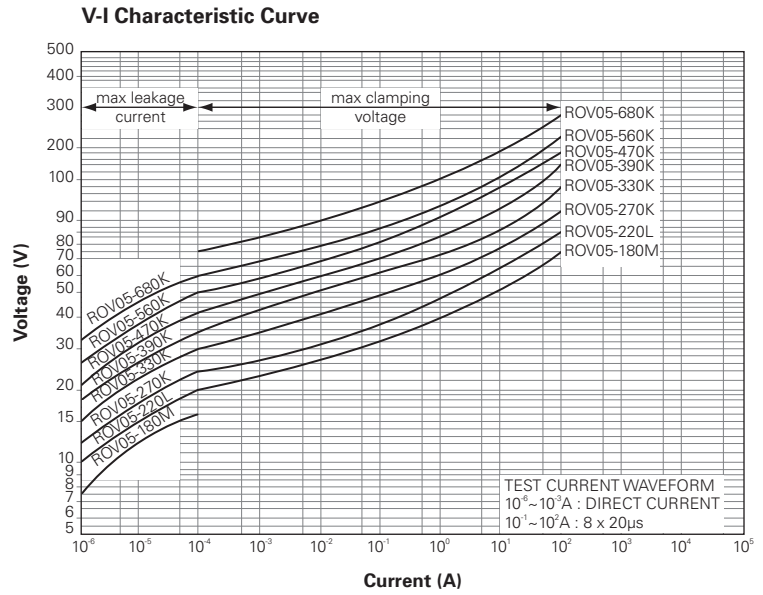
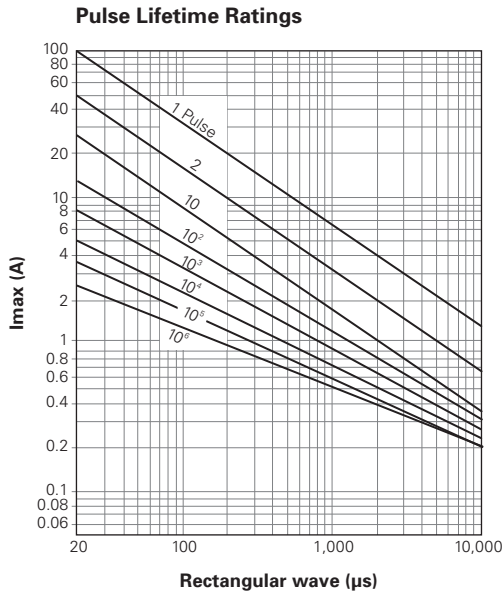

Figure V4 - ROV05-820K-ROV05-471K

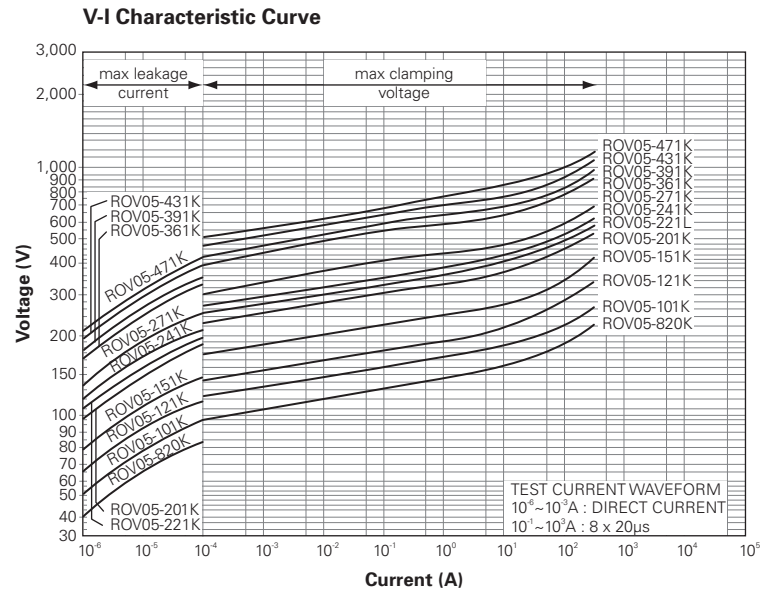
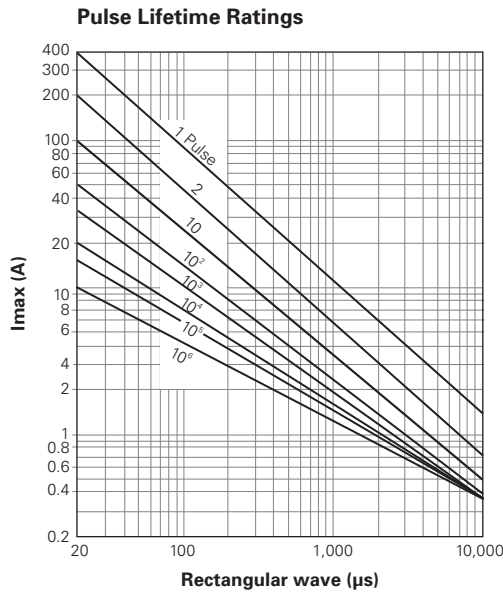

Table V5 Rating and Characteristics for Standard Series Specifications — 7mm Devices

Part Number	Varistor Voltage V@1.0mA		Maximum Allowance Voltage		Maximum Clamping Voltage	Maximum Surge Current (8x20µs)		Rated Wairage	Energy (10x1000µs)	Capacitance (Typical)	Certification†
	DC (V)	Tolerance	AC (V _{RMS})	DC (V)	V@10A (V)	1 Time (A)	2 Times (A)	(W)	(J)	(pF)	
ROV07-180M	18	±20%	11	14	36*	250	125	0.02	1.2	2918	● ■
ROV07-220L	22	±15%	14	18	43*	250	125	0.02	1.4	2933	● ■
ROV07-270K	27	±10%	17	22	53*	250	125	0.02	1.7	2344	● ■
ROV07-330K	33	±10%	20	26	65*	250	125	0.02	2.2	1840	● ■
ROV07-390K	39	±10%	25	31	77*	250	125	0.02	2.4	1817	● ■
ROV07-470K	47	±10%	30	38	93*	250	125	0.02	3.0	1595	● ■
ROV07-560K	56	±10%	35	45	110*	250	125	0.02	3.5	1333	● ■
ROV07-680K	68	±10%	40	56	135*	250	125	0.02	4.3	1119	● ■
ROV07-820K	82	±10%	50	65	135	1200	600	0.25	5.5	643	● ■
ROV07-101K	100	±10%	60	85	165	1200	600	0.25	7.0	535	● ■
ROV07-121K	120	±10%	75	100	200	1200	600	0.25	8.0	457	● ■
ROV07-151K	150	±10%	95	125	250	1200	600	0.25	11.0	371	● ■
ROV07-181K	180	±10%	115	150	300	1200	600	0.25	13.0	215	● ■
ROV07-201K	200	±10%	130	170	340	1200	600	0.25	14.3	224	◆ ● ▲ ■
ROV07-221K	220	±10%	140	180	360	1200	600	0.25	15.5	190	◆ ● ▲ ■
ROV07-241K	240	±10%	150	200	395	1200	600	0.25	16.8	185	◆ ● ▲ ■
ROV07-271K	270	±10%	175	225	455	1200	600	0.25	19.8	161	◆ ● ▲ ■
ROV07-301K	300	±10%	195	250	505	1200	600	0.25	21.0	135	◆ ● ▲ ■
ROV07-331K	330	±10%	210	275	550	1200	600	0.25	23.0	141	◆ ● ▲ ■
ROV07-361K	360	±10%	230	300	595	1200	600	0.25	26.0	117	◆ ● ▲ ■
ROV07-391K	390	±10%	250	320	650	1200	600	0.25	30.0	110	◆ ● ▲ ■
ROV07-431K	430	±10%	275	350	710	1200	600	0.25	33.0	111	◆ ● ▲ ■
ROV07-471K	470	±10%	300	385	775	1200	600	0.25	35.0	102	◆ ● ▲ ■
ROV07-511K	510	±10%	320	418	842	1200	600	0.25	37.0	100	◆ ● ▲ ■
ROV07-561K	560	±10%	350	460	920	1200	600	0.25	39.0	87	◆ ● ▲ ■
ROV07-621K	620	±10%	385	505	1025	1200	600	0.25	41.0	80	◆ ● ▲ ■
ROV07-681K	680	±10%	420	560	1120	1200	600	0.25	43.0	82	◆ ● ▲ ■
ROV07-751K	750	±10%	460	615	1240	1200	600	0.25	45.0	74	◆ ● ▲ ■
ROV07-781K	780	±10%	485	640	1290	1200	600	0.25	46.0	70	◆ ● ▲ ■
ROV07-821K	820	±10%	510	670	1355	1200	600	0.25	47.0	70	◆ ● ▲ ■

* The clamping voltages from 180M to 680K are tested at 2.5A current.

†Certification

Standard	UL1414‡	UL1449 (2nd Edition)‡	CSA	VDE
Title	Across-the-Line Components	Transient Voltage Surge Suppressors	Accessories and Parts for Electronic Equipment	Varistors for Use in Electronic Equipment
Symbols	◆	●	▲	■
File Number	E223034	E223033	220978	40006997

‡ For UL 1449 (2nd Edition), the maximum clamping voltage is measured at 500A.

Figure V5-V6 Standard Series Specifications — 7mm Devices
Pulse Lifetime Ratings and V-I Characteristic Curves

Figure V5 - ROV07-180M-ROV07-680K

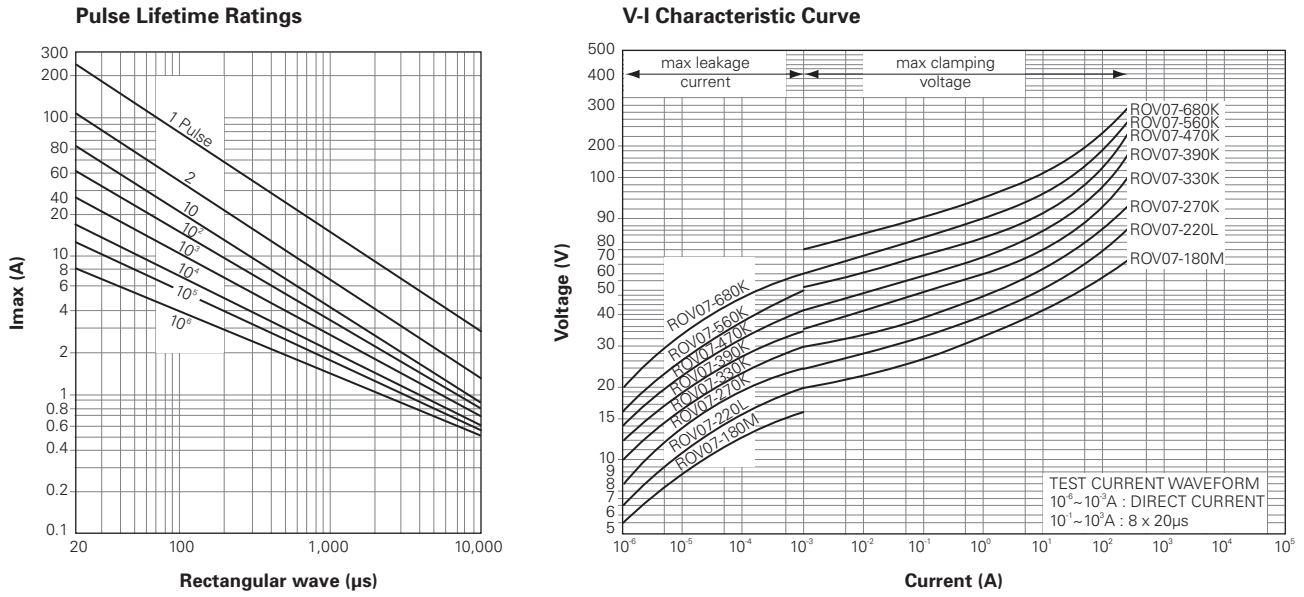

Figure V6 - ROV07-820K-ROV07-471K

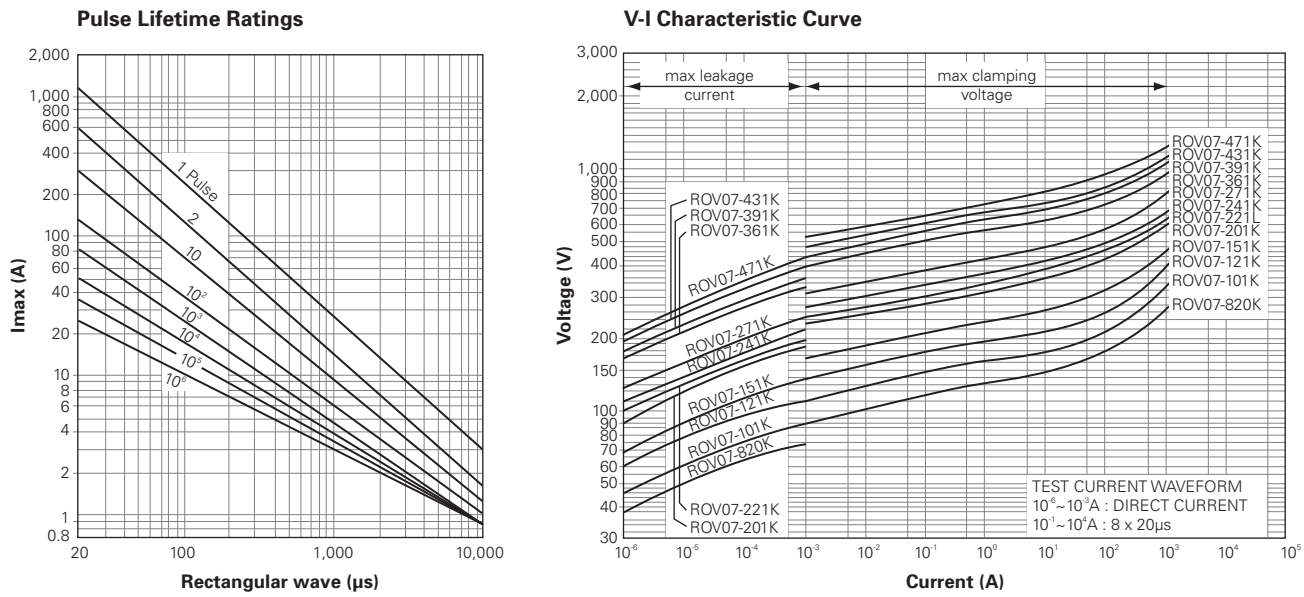

Table V6 Rating and Characteristics for Standard Series Specifications – 10mm Devices

Part Number	Varistor Voltage V@1.0mA		Maximum Allowance Voltage		Maximum Clamping Voltage	Maximum Surge Current (8x20µs)		Rated Woltage	Energy (10x1000µs)	Capacitance (Typical)	Certification†
	DC (V)	Tolerance	AC (V _{RMS})	DC (V)	V@25A (V)	1 Time (A)	2 Times (A)	(W)	(J)	(pF)	
ROV10-180M	18	±20%	11	14	36*	500	250	0.05	2.4	6500	● ■
ROV10-220L	22	±15%	14	18	43*	500	250	0.05	2.7	5521	● ■
ROV10-270K	27	±10%	17	22	53*	500	250	0.05	3.5	4742	● ■
ROV10-330K	33	±10%	20	26	65*	500	250	0.05	4.4	4247	● ■
ROV10-390K	39	±10%	25	31	77*	500	250	0.05	4.7	3658	● ■
ROV10-470K	47	±10%	30	38	93*	500	250	0.05	6.0	3137	● ■
ROV10-560K	56	±10%	35	45	110*	500	250	0.05	7.0	2900	● ■
ROV10-680K	68	±10%	40	56	135*	500	250	0.05	8.5	2230	● ■
ROV10-820K	82	±10%	50	65	135	2500	1250	0.40	11.0	1261	● ■
ROV10-101K	100	±10%	60	85	165	2500	1250	0.40	14.0	1021	● ■
ROV10-121K	120	±10%	75	100	200	2500	1250	0.40	16.0	946	● ■
ROV10-151K	150	±10%	95	125	250	2500	1250	0.40	22.0	733	● ■
ROV10-181K	180	±10%	115	150	300	2500	1250	0.40	26.0	483	● ■
ROV10-201K	200	±10%	130	170	340	2500	1250	0.40	28.5	400	◆ ● ▲ ■
ROV10-221K	220	±10%	140	180	360	2500	1250	0.40	31.0	393	◆ ● ▲ ■
ROV10-241K	240	±10%	150	200	395	2500	1250	0.40	33.5	325	◆ ● ▲ ■
ROV10-271K	270	±10%	175	225	455	2500	1250	0.40	39.5	334	◆ ● ▲ ■
ROV10-301K	300	±10%	195	250	505	2500	1250	0.40	42.0	278	◆ ● ▲ ■
ROV10-331K	330	±10%	210	275	550	2500	1250	0.40	46.0	275	◆ ● ▲ ■
ROV10-361K	360	±10%	230	300	595	2500	1250	0.40	52.0	231	◆ ● ▲ ■
ROV10-391K	390	±10%	250	320	650	2500	1250	0.40	60.0	247	◆ ● ▲ ■
ROV10-431K	430	±10%	275	350	710	2500	1250	0.40	66.0	216	◆ ● ▲ ■
ROV10-471K	470	±10%	300	385	775	2500	1250	0.40	70.0	210	◆ ● ▲ ■
ROV10-511K	510	±10%	320	418	842	2500	1250	0.40	74.0	187	◆ ● ▲ ■
ROV10-561K	560	±10%	350	460	920	2500	1250	0.40	78.0	186	◆ ● ▲ ■
ROV10-621K	620	±10%	385	505	1025	2500	1250	0.40	82.0	160	◆ ● ▲ ■
ROV10-681K	680	±10%	420	560	1120	2500	1250	0.40	86.0	156	◆ ● ▲ ■
ROV10-751K	750	±10%	460	615	1240	2500	1250	0.40	90.0	133	◆ ● ▲ ■
ROV10-781K	780	±10%	485	640	1290	2500	1250	0.40	92.0	117	◆ ● ▲ ■
ROV10-821K	820	±10%	510	670	1355	2500	1250	0.40	94.0	130	◆ ● ▲ ■
ROV10-911K	910	±10%	550	745	1500	2500	1250	0.40	102.0	111	◆ ● ▲ ■
ROV10-102K	1000	±10%	625	825	1650	2500	1250	0.40	112.0	96	◆ ● ▲ ■
ROV10-112K	1100	±10%	680	895	1815	2500	1250	0.40	124.0	88	◆ ● ▲ ■
ROV10-182K	1800	±10%	1000	1465	2970	2500	1250	0.40	174.0	65	◆ ● ▲ ■

* The clamping voltages from 180M to 680K are tested at 5A current.

†Certification

Standard	UL1414‡	UL1449 (2nd Edition)‡	CSA	VDE
Title	Across-the-Line Components	Transient Voltage Surge Suppressors	Accessories and Parts for Electronic Equipment	Varistors for Use in Electronic Equipment
Symbols	◆	●	▲	■
File Number	E223034	E223033	220978	40006997

‡ For UL 1449 (2nd Edition), the maximum clamping voltage is measured at 500A.

Figure V7-V9 Standard Series Specifications – 10mm Devices Pulse Lifetime Ratings and V-I Characteristic Curves

Figure V7 - ROV10-180M-ROV10-680K

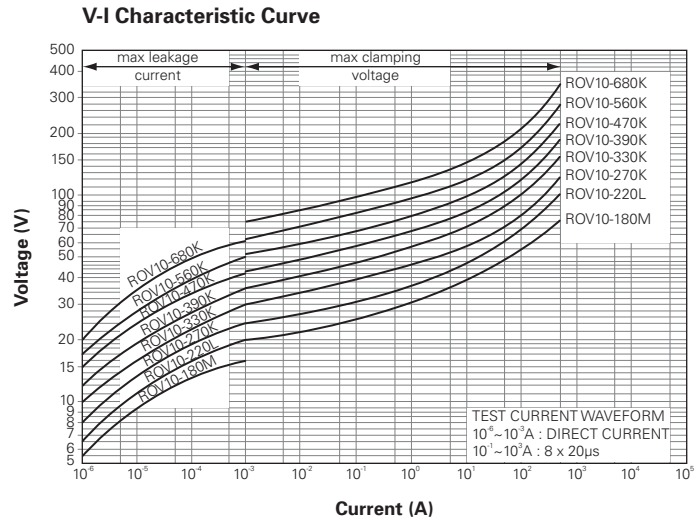
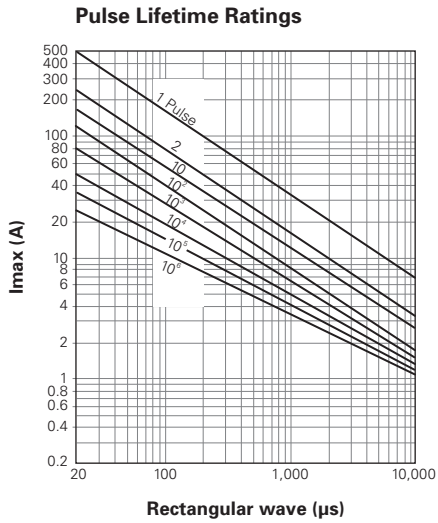

Figure V8 - ROV10-820K-ROV10-511K

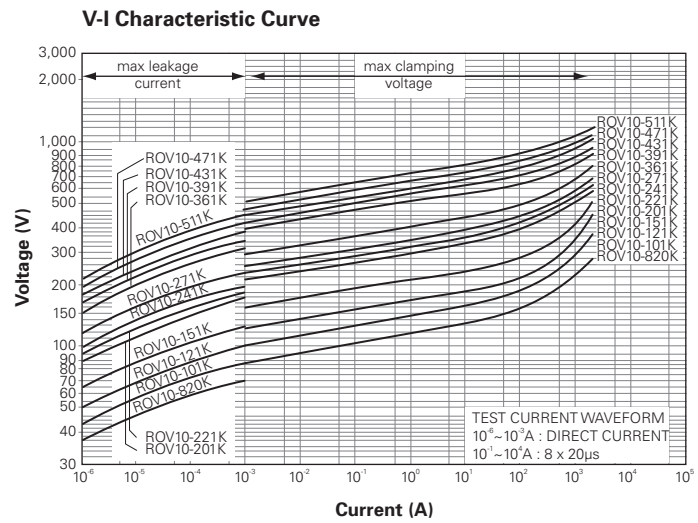
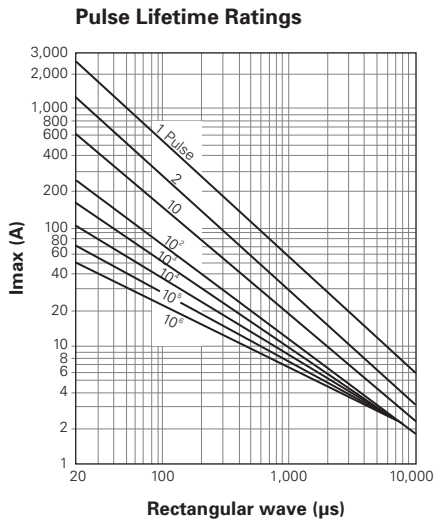

Figure V9 - ROV10-561K-ROV10-182K

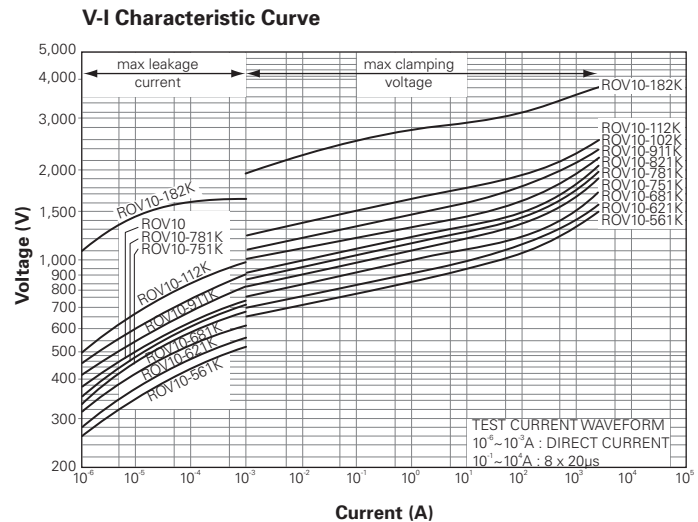
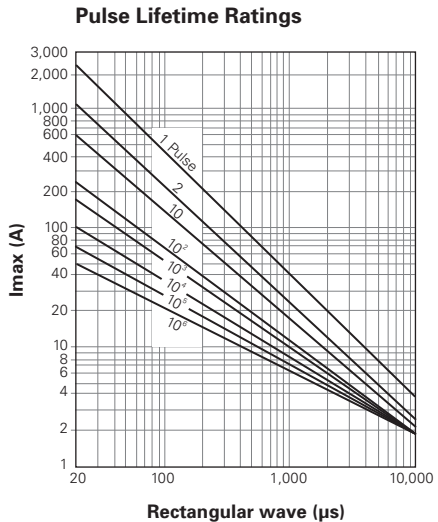

Table V7 Rating and Characteristics for Standard Series Specifications – 14mm Devices

Part Number	Varistor Voltage V@1.0mA		Maximum Allowance Voltage		Maximum Clamping Voltage	Maximum Surge Current (8x20µs)		Rated Woltage	Energy (10x1000µs)	Capacitance (Typical)	Certification†
	DC (V)	Tolerance	AC (V _{RMS})	DC (V)	V@50A (V)	1 Time (A)	2 Times (A)	(W)	(J)	(pF)	
ROV14-180M	18	±20%	11	14	36*	1000	500	0.1	4.7	14898	● ■
ROV14-220L	22	±15%	14	18	43*	1000	500	0.1	5.4	11957	● ■
ROV14-270K	27	±10%	17	22	53*	1000	500	0.1	6.9	9731	● ■
ROV14-330K	33	±10%	20	26	65*	1000	500	0.1	8.8	7704	● ■
ROV14-390K	39	±10%	25	31	77*	1000	500	0.1	9.4	7622	● ■
ROV14-470K	47	±10%	30	38	93*	1000	500	0.1	12.0	6417	● ■
ROV14-560K	56	±10%	35	45	110*	1000	500	0.1	14.0	5184	● ■
ROV14-680K	68	±10%	40	56	135*	1000	500	0.1	17.0	5099	● ■
ROV14-820K	82	±10%	50	65	135	4500	2500	0.6	22.0	2965	● ■
ROV14-101K	100	±10%	60	85	165	4500	2500	0.6	28.0	2221	● ■
ROV14-121K	120	±10%	75	100	200	4500	2500	0.6	32.0	1742	● ■
ROV14-151K	150	±10%	95	125	250	4500	2500	0.6	44.0	1510	● ■
ROV14-181K	180	±10%	115	150	300	4500	2500	0.6	52.0	922	● ■
ROV14-201K	200	±10%	130	170	340	4500	2500	0.6	57.0	845	◆ ● ▲ ■
ROV14-221K	220	±10%	140	180	360	4500	2500	0.6	62.0	713	◆ ● ▲ ■
ROV14-241K	240	±10%	150	200	395	4500	2500	0.6	67.0	769	◆ ● ▲ ■
ROV14-271K	270	±10%	175	225	455	4500	2500	0.6	79.0	655	◆ ● ▲ ■
ROV14-301K	300	±10%	195	250	505	4500	2500	0.6	84.0	650	◆ ● ▲ ■
ROV14-331K	330	±10%	210	275	550	4500	2500	0.6	92.0	613	◆ ● ▲ ■
ROV14-361K	360	±10%	230	300	595	4500	2500	0.6	104.0	465	◆ ● ▲ ■
ROV14-391K	390	±10%	250	320	650	4500	2500	0.6	120.0	458	◆ ● ▲ ■
ROV14-431K	430	±10%	275	350	710	4500	2500	0.6	132.0	454	◆ ● ▲ ■
ROV14-471K	470	±10%	300	385	775	4500	2500	0.6	140.0	413	◆ ● ▲ ■
ROV14-511K	510	±10%	320	418	842	4500	2500	0.6	148.0	374	◆ ● ▲ ■
ROV14-561K	560	±10%	350	460	920	4500	2500	0.6	156.0	398	◆ ● ▲ ■
ROV14-621K	620	±10%	385	505	1025	4500	2500	0.6	164.0	305	◆ ● ▲ ■
ROV14-681K	680	±10%	420	560	1120	4500	2500	0.6	172.0	312	◆ ● ▲ ■
ROV14-751K	750	±10%	460	615	1240	4500	2500	0.6	180.0	270	◆ ● ▲ ■
ROV14-781K	780	±10%	485	640	1290	4500	2500	0.6	184.0	252	◆ ● ▲ ■
ROV14-821K	820	±10%	510	670	1355	4500	2500	0.6	188.0	265	◆ ● ▲ ■
ROV14-911K	910	±10%	550	745	1500	4500	2500	0.6	204.0	240	◆ ● ▲ ■
ROV14-102K	1000	±10%	625	825	1650	4500	2500	0.6	224.0	200	◆ ● ▲ ■
ROV14-112K	1100	±10%	680	895	1815	4500	2500	0.6	248.0	180	◆ ● ▲ ■
ROV14-182K	1800	±10%	1000	1465	2970	4500	2500	0.6	348.0	118	◆ ● ▲ ■

* The clamping voltages from 180M to 680K are tested at 10A current.

† Certification

Standard	UL1414‡	UL1449 (2nd Edition)‡	CSA	VDE
Title	Across-the-Line Components	Transient Voltage Surge Suppressors	Accessories and Parts for Electronic Equipment	Varistors for Use in Electronic Equipment
Symbols	◆	●	▲	■
File Number	E223034	E223033	220978	40006997

‡ For UL 1449 (2nd Edition), the maximum clamping voltage is measured at 500A.

Figure V10-V12 Standard Series Specifications – 14mm Devices Pulse Lifetime Ratings and V-I Characteristic Curves

Figure V10 - ROV14-180M-ROV14-680K

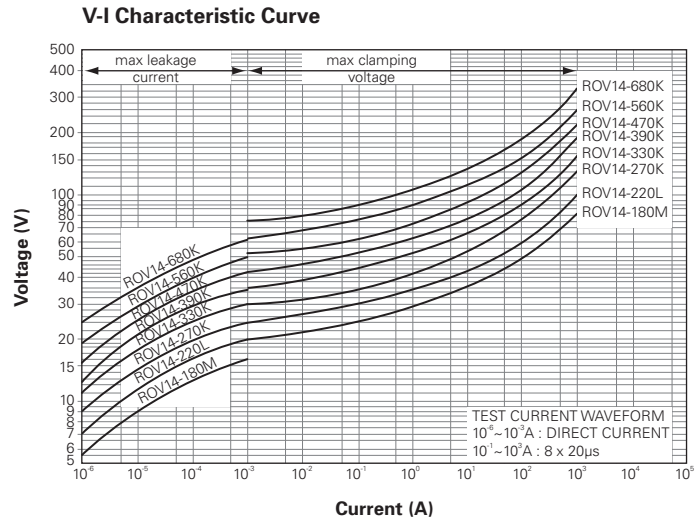
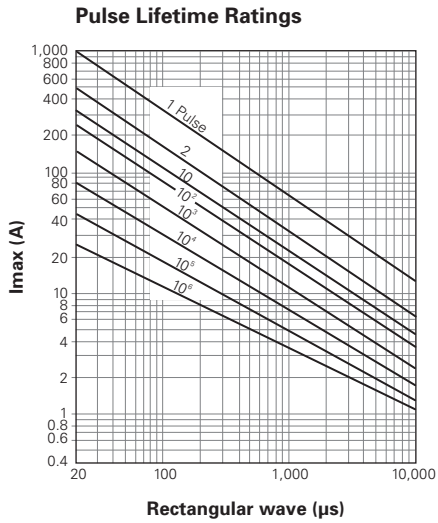

Figure V11 - ROV14-820K-ROV14-511K

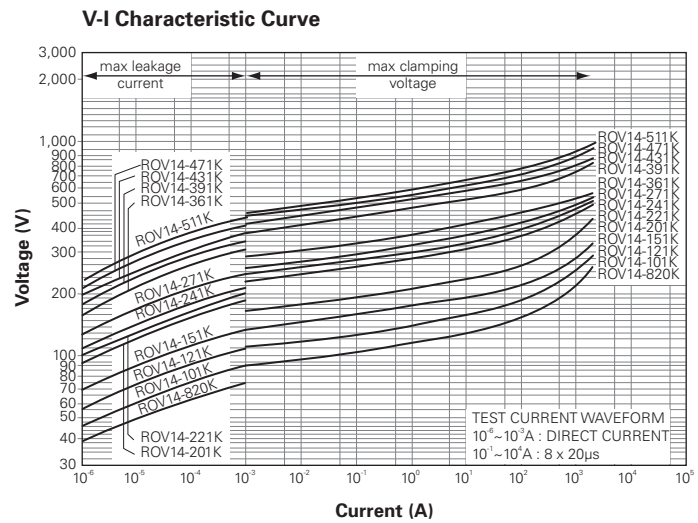
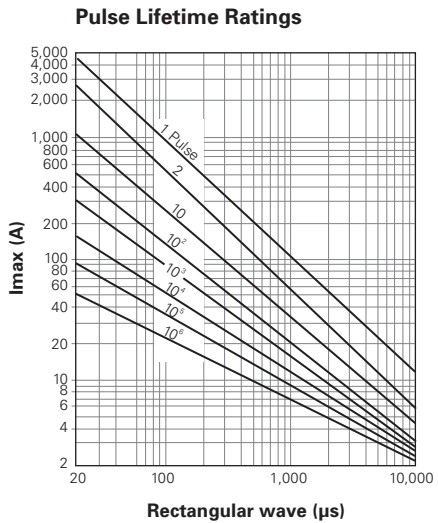

Figure V12 - ROV14-561K-ROV14-182K

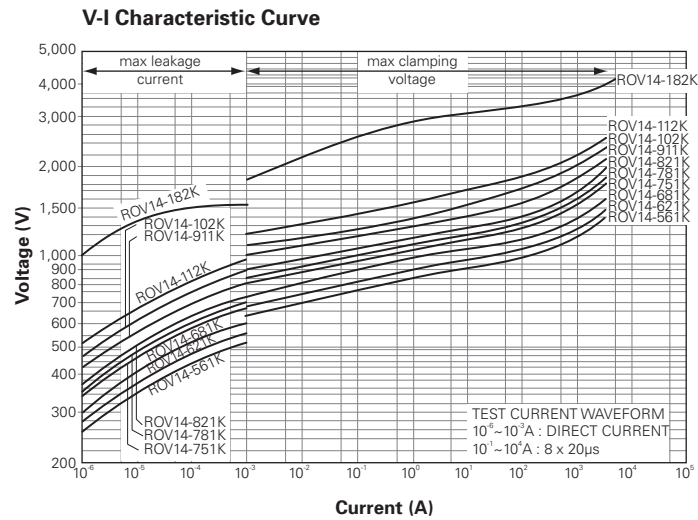
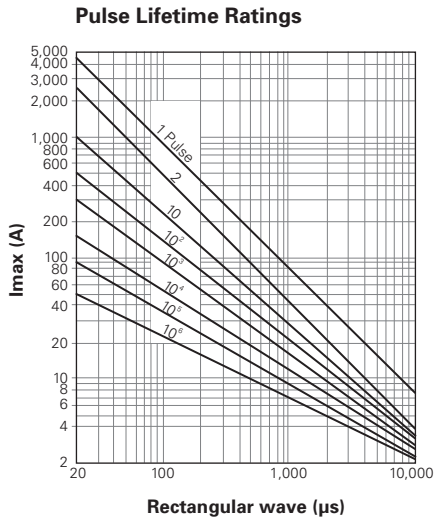

Table V8 Rating and Characteristics for Standard Series Specifications – 20mm Devices

Part Number	Varistor Voltage V@1.0mA		Maximum Allowance Voltage		Maximum Clamping Voltage	Maximum Surge Current (8x20µs)		Rated Woltage (W)	Energy (10x1000µs) (J)	Capacitance (Typical) (pF)	Certification†
	DC (V)	Tolerance	AC (V _{RMS})	DC (V)	V@100A (V)	1 Time (A)	2 Times (A)				
ROV20-220M	22	±20%	14	18	43*	2000	1000	0.2	8.0	21200	● ■
ROV20-270M	27	±20%	17	22	53*	2000	1000	0.2	10.0	20000	● ■
ROV20-330M	33	±20%	20	26	65*	2000	1000	0.2	12.0	17200	● ■
ROV20-390L	39	±15%	25	31	77*	2000	1000	0.2	14.0	15003	● ■
ROV20-470L	47	±15%	30	38	93*	2000	1000	0.2	17.0	12080	● ■
ROV20-560L	56	±15%	35	45	110*	2000	1000	0.2	20.0	11600	● ■
ROV20-680L	68	±15%	40	56	135*	2000	1000	0.2	24.0	9600	● ■
ROV20-101K	100	±10%	60	85	165	6500	4000	1.0	56.0	4000	● ■
ROV20-121K	120	±10%	75	100	200	6500	4000	1.0	64.0	3800	● ■
ROV20-151K	150	±10%	95	125	250	6500	4000	1.0	88.0	3000	● ■
ROV20-181K	180	±10%	115	150	300	6500	4000	1.0	104.0	2400	● ■
ROV20-201K	200	±10%	130	170	340	6500	4000	1.0	114.0	1829	◆ ● ▲ ■
ROV20-221K	220	±10%	140	180	360	6500	4000	1.0	124.0	1600	◆ ● ▲ ■
ROV20-241K	240	±10%	150	200	395	6500	4000	1.0	134.0	1422	◆ ● ▲ ■
ROV20-271K	270	±10%	175	225	455	6500	4000	1.0	158.0	1261	◆ ● ▲ ■
ROV20-301K	300	±10%	195	250	505	6500	4000	1.0	168.0	1100	◆ ● ▲ ■
ROV20-331K	330	±10%	210	275	550	6500	4000	1.0	184.0	1106	◆ ● ▲ ■
ROV20-361K	360	±10%	230	300	595	6500	4000	1.0	208.0	987	◆ ● ▲ ■
ROV20-391K	390	±10%	250	320	650	6500	4000	1.0	240.0	975	◆ ● ▲ ■
ROV20-431K	430	±10%	275	350	710	6500	4000	1.0	264.0	858	◆ ● ▲ ■
ROV20-471K	470	±10%	300	385	775	6500	4000	1.0	280.0	761	◆ ● ▲ ■
ROV20-511K	510	±10%	320	418	842	6500	4000	1.0	296.0	792	◆ ● ▲ ■
ROV20-561K	560	±10%	350	460	920	6500	4000	1.0	312.0	679	◆ ● ▲ ■
ROV20-621K	620	±10%	385	505	1025	6500	4000	1.0	328.0	605	◆ ● ▲ ■
ROV20-681K	680	±10%	420	560	1120	6500	4000	1.0	344.0	553	◆ ● ▲ ■
ROV20-751K	750	±10%	460	615	1240	6500	4000	1.0	360.0	554	◆ ● ▲ ■
ROV20-781K	780	±10%	485	640	1290	6500	4000	1.0	368.0	481	◆ ● ▲ ■
ROV20-821K	820	±10%	510	670	1355	6500	4000	1.0	376.0	519	◆ ● ▲ ■
ROV20-911K	910	±10%	550	745	1500	6500	4000	1.0	408.0	444	◆ ● ▲ ■
ROV20-102K	1000	±10%	625	825	1650	6500	4000	1.0	448.0	400	◆ ● ▲ ■
ROV20-112K	1100	±10%	680	895	1815	6500	4000	1.0	496.0	360	◆ ● ▲ ■
ROV20-182K	1800	±10%	1000	1465	2970	6500	4000	1.0	695.0	260	◆ ● ▲ ■

* The clamping voltages from 180M to 680K are tested at 20A current.

†Certification

Standard	UL1414‡	UL1449 (2nd Edition)‡	CSA	VDE
Title	Across-the-Line Components	Transient Voltage Surge Suppressors	Accessories and Parts for Electronic Equipment	Varistors for Use in Electronic Equipment
Symbols	◆	●	▲	■
File Number	E223034	E223033	220978	40006997

‡ For UL 1449 (2nd Edition), the maximum clamping voltage is measured at 500A.

Figure V13-V15 Standard Series Specifications – 20mm Devices Pulse Lifetime Ratings and V-I Characteristic Curves

Figure V13 - ROV20-220M-ROV20-680L

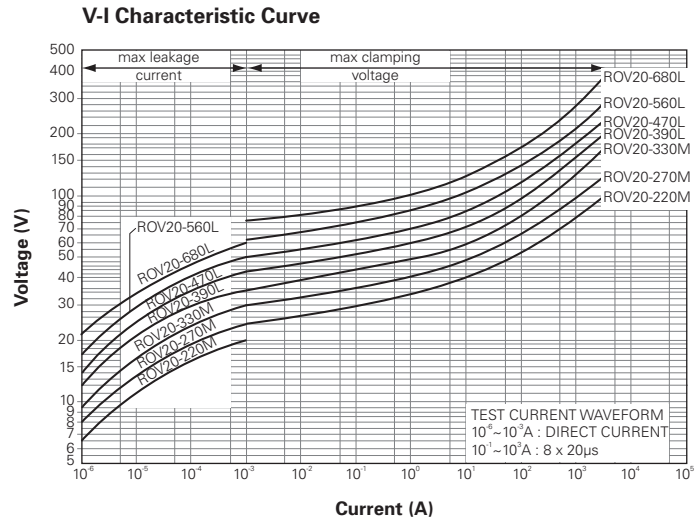
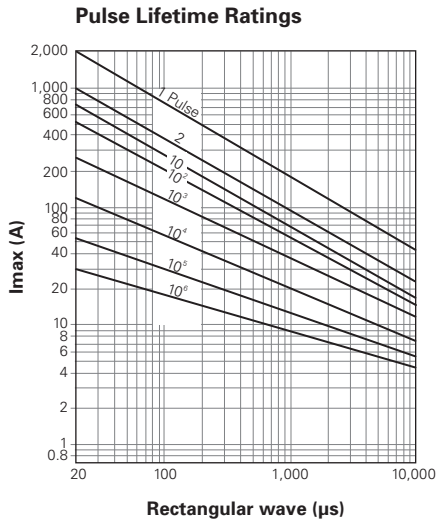

Figure V14 - ROV20-101K-ROV20-511K

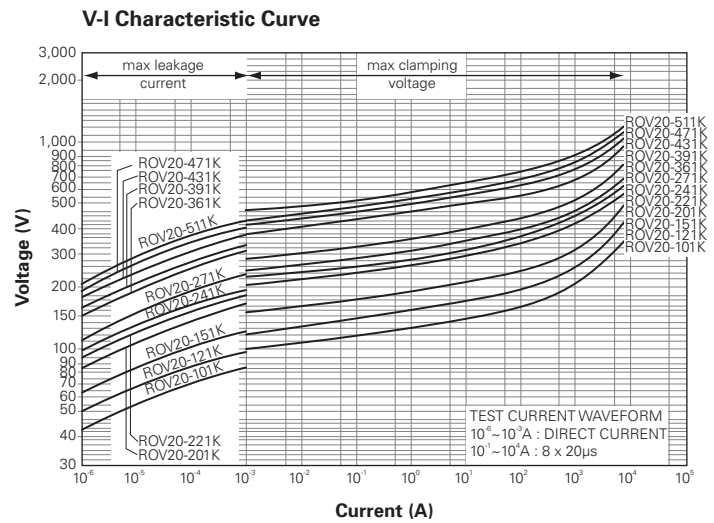
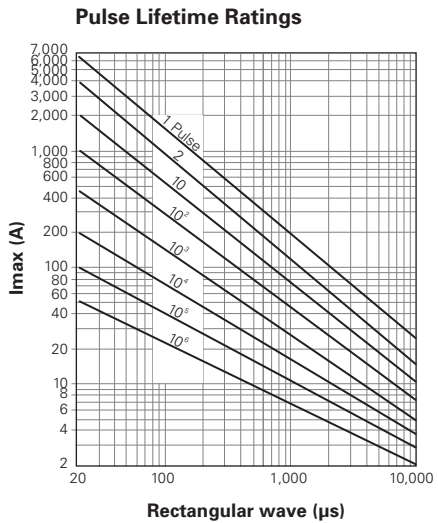

Figure V15 - ROV20-561K-ROV20-182K

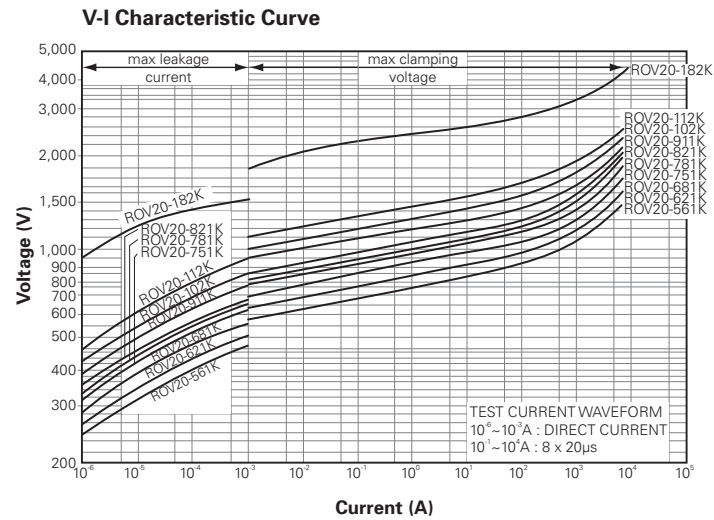
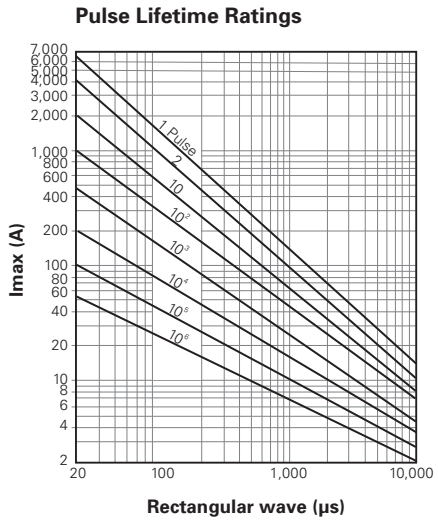

Table V9 Rating and Characteristics for H Series Specifications — 5mm Devices

Part Number	Varistor Voltage V@0.1mA		Maximum Allowance Voltage		Maximum Clamping Voltage	Maximum Surge Current (8x20µs)		Rated Woltage	Energy (10x1000µs)	Capacitance (Typical)	Certification†
	DC (V)	Tolerance	AC (V _{RMS})	DC (V)	V@5A (V)	1 Time (A)	2 Times (A)	(W)	(J)	(pF)	
ROV05H180M	18	±20%	11	14	40*	250	125	0.01	0.7	1120	● ■
ROV05H220L	22	±15%	14	18	48*	250	125	0.01	0.8	1230	● ■
ROV05H270K	27	±10%	17	22	60*	250	125	0.01	1.1	1070	● ■
ROV05H330K	33	±10%	20	26	73*	250	125	0.01	1.3	830	● ■
ROV05H390K	39	±10%	25	31	86*	250	125	0.01	1.5	880	● ■
ROV05H470K	47	±10%	30	38	104*	250	125	0.01	1.8	720	● ■
ROV05H560K	56	±10%	35	45	123*	250	125	0.01	2.2	640	● ■
ROV05H680K	68	±10%	40	56	150*	250	125	0.01	2.6	500	● ■
ROV05H820K	82	±10%	50	65	145	800	600	0.10	3.5	270	● ■
ROV05H101K	100	±10%	60	85	175	800	600	0.10	4.5	260	● ■
ROV05H121K	120	±10%	75	100	210	800	600	0.10	5.5	180	● ■
ROV05H151K	150	±10%	95	125	260	800	600	0.10	6.5	180	● ■
ROV05H181K	180	±10%	115	150	320	800	600	0.10	8.0	95	● ■
ROV05H201K	200	±10%	130	170	355	800	600	0.10	8.5	85	◆ ● ▲ ■
ROV05H221K	220	±10%	140	180	380	800	600	0.10	9.0	80	◆ ● ▲ ■
ROV05H241K	240	±10%	150	200	415	800	600	0.10	10.5	75	◆ ● ▲ ■
ROV05H271K	270	±10%	175	225	475	800	600	0.10	11.0	70	◆ ● ▲ ■
ROV05H301K	300	±10%	195	250	525	800	600	0.10	12.0	65	◆ ● ▲ ■
ROV05H331K	330	±10%	210	275	575	800	600	0.10	13.0	60	◆ ● ▲ ■
ROV05H361K	360	±10%	230	300	620	800	600	0.10	16.0	70	◆ ● ▲ ■
ROV05H391K	390	±10%	250	320	675	800	600	0.10	17.0	55	◆ ● ▲ ■
ROV05H431K	430	±10%	275	350	745	800	600	0.10	20.0	45	◆ ● ▲ ■
ROV05H471K	470	±10%	300	385	810	800	600	0.10	21.0	50	◆ ● ▲ ■
ROV05H511K	510	±10%	320	418	880	800	600	0.10	22.0	50	◆ ● ▲ ■
ROV05H561K	560	±10%	350	460	940	800	600	0.10	25.0	50	◆ ● ▲ ■
ROV05H621K	620	±10%	385	505	1050	800	600	0.10	27.0	50	◆ ● ▲ ■
ROV05H681K	680	±10%	420	560	1150	800	600	0.10	28.0	40	◆ ● ▲ ■
ROV05H751K	750	±10%	460	615	1290	800	600	0.10	29.0	—	◆ ● ▲ ■

* The clamping voltages from 180M to 680K are tested at 1A current.

†Certification

Standard	UL1414‡	UL1449 (2nd Edition)‡	CSA	VDE
Title	Across-the-Line Components	Transient Voltage Surge Suppressors	Accessories and Parts for Electronic Equipment	Varistors for Use in Electronic Equipment
Symbols	◆	●	▲	■
File Number	E223034	E223033	220978	40006997

‡ For UL 1449 (2nd Edition), the maximum clamping voltage is measured at 500A.

Figure V16-V17 H Series Specifications – 5mm Devices
Pulse Lifetime Ratings and V-I Characteristic Curves

Figure V16 - ROV05H180M-ROV05H680K

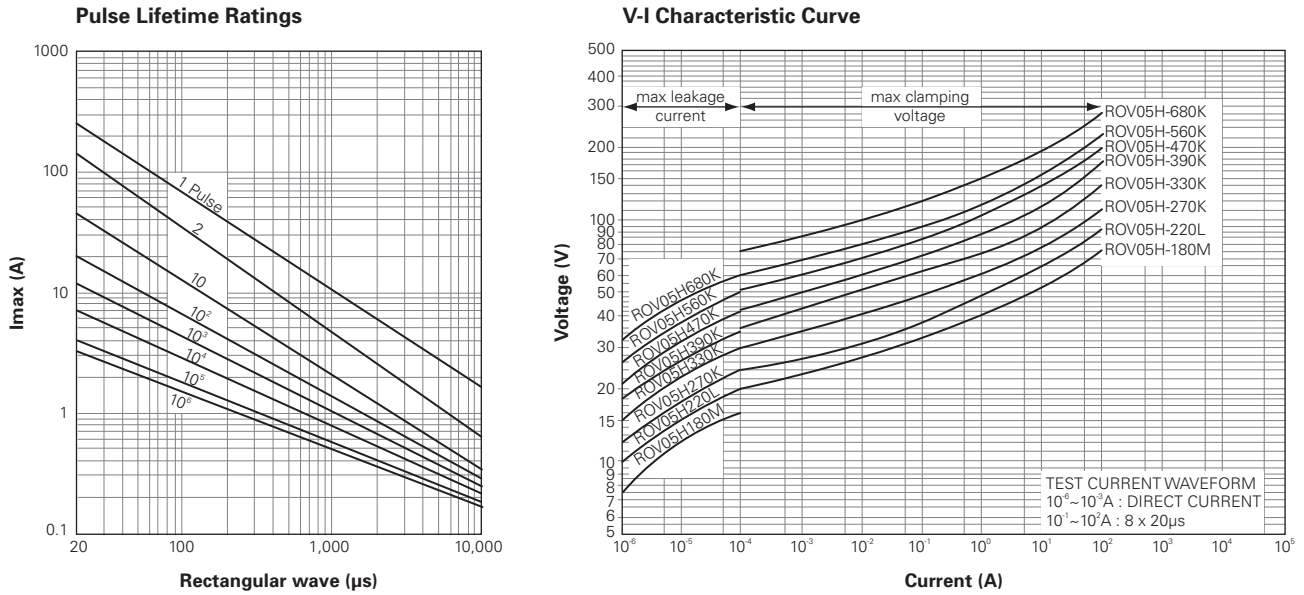

Figure V17 - ROV05H820K-ROV05H471K

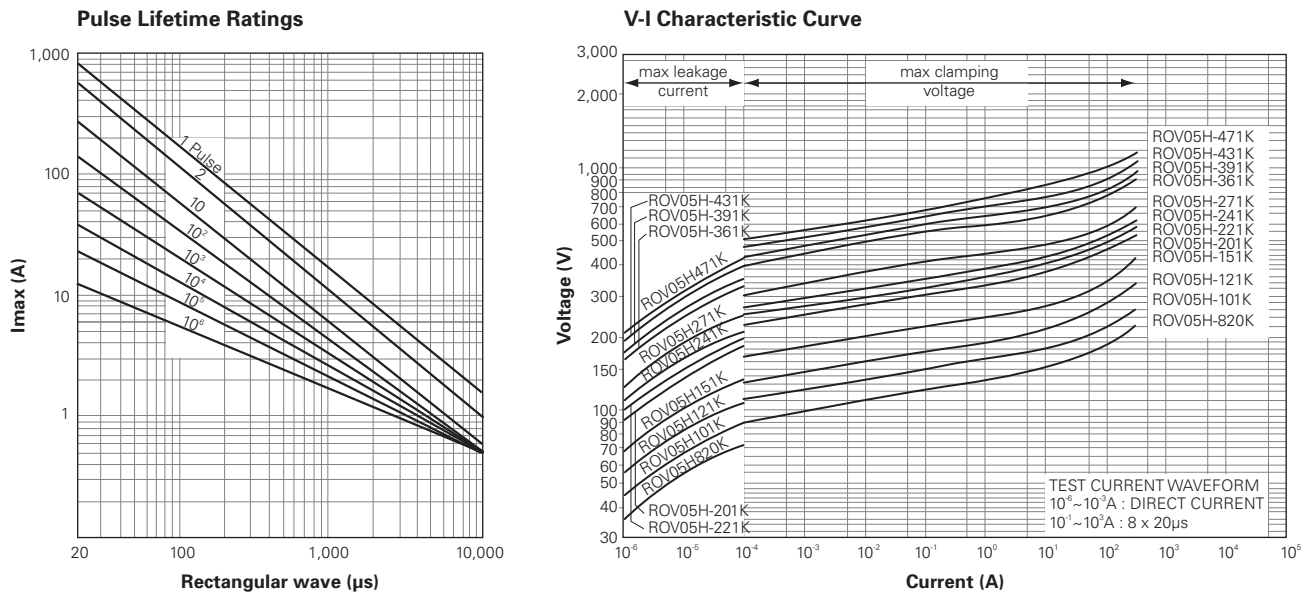

Table V10 Rating and Characteristics for H Series Specifications — 7mm Devices

Part Number	Varistor Voltage V@1.0mA		Maximum Allowance Voltage		Maximum Clamping Voltage	Maximum Surge Current (8x20µs)		Rated Woltage	Energy (10x1000µs)	Capacitance (Typical)	Certification†
	DC (V)	Tolerance	AC (V _{RMS})	DC (V)	V@10A (V)	1 Time (A)	2 Times (A)	(W)	(J)	(pF)	
ROV07H180M	18	±20%	11	14	36*	500	250	0.02	1.5	2920	● ■
ROV07H220L	22	±15%	14	18	43*	500	250	0.02	1.7	2930	● ■
ROV07H270K	27	±10%	17	22	53*	500	250	0.02	2.1	2340	● ■
ROV07H330K	33	±10%	20	26	65*	500	250	0.02	2.8	1840	● ■
ROV07H390K	39	±10%	25	31	77*	500	250	0.02	3.0	1820	● ■
ROV07H470K	47	±10%	30	38	93*	500	250	0.02	3.8	1600	● ■
ROV07H560K	56	±10%	35	45	110*	500	250	0.02	4.4	1330	● ■
ROV07H680K	68	±10%	40	56	135*	500	250	0.02	5.4	1120	● ■
ROV07H820K	82	±10%	50	65	135	1750	1250	0.25	7.0	640	● ■
ROV07H101K	100	±10%	60	85	165	1750	1250	0.25	9.0	540	● ■
ROV07H121K	120	±10%	75	100	200	1750	1250	0.25	11.0	460	● ■
ROV07H151K	150	±10%	95	125	250	1750	1250	0.25	13.0	370	● ■
ROV07H181K	180	±10%	115	150	300	1750	1250	0.25	16.0	220	● ■
ROV07H201K	200	±10%	130	170	340	1750	1250	0.25	17.5	220	◆ ● ▲ ■
ROV07H221K	220	±10%	140	180	360	1750	1250	0.25	19.0	190	◆ ● ▲ ■
ROV07H241K	240	±10%	150	200	395	1750	1250	0.25	21.0	190	◆ ● ▲ ■
ROV07H271K	270	±10%	175	225	455	1750	1250	0.25	24.0	160	◆ ● ▲ ■
ROV07H301K	300	±10%	195	250	505	1750	1250	0.25	26.0	140	◆ ● ▲ ■
ROV07H331K	330	±10%	210	275	550	1750	1250	0.25	28.0	140	◆ ● ▲ ■
ROV07H361K	360	±10%	230	300	595	1750	1250	0.25	32.0	120	◆ ● ▲ ■
ROV07H391K	390	±10%	250	320	650	1750	1250	0.25	35.0	110	◆ ● ▲ ■
ROV07H431K	430	±10%	275	350	710	1750	1250	0.25	40.0	110	◆ ● ▲ ■
ROV07H471K	470	±10%	300	385	775	1750	1250	0.25	42.0	100	◆ ● ▲ ■
ROV07H511K	510	±10%	320	418	842	1750	1250	0.25	45.0	100	◆ ● ▲ ■
ROV07H561K	560	±10%	350	460	920	1750	1250	0.25	51.0	85	◆ ● ▲ ■
ROV07H621K	620	±10%	385	505	1025	1750	1250	0.25	54.0	80	◆ ● ▲ ■
ROV07H681K	680	±10%	420	560	1120	1750	1250	0.25	56.0	80	◆ ● ▲ ■
ROV07H751K	750	±10%	460	615	1240	1750	1250	0.25	58.0	75	◆ ● ▲ ■
ROV07H781K	780	±10%	485	640	1290	1750	1250	0.25	59.0	70	◆ ● ▲ ■
ROV07H821K	820	±10%	510	670	1355	1750	1250	0.25	60.0	70	◆ ● ▲ ■

* The clamping voltages from 180M to 680K are tested at 2.5A current.

† Certification

Standard	UL1414‡	UL1449 (2nd Edition)‡	CSA	VDE
Title	Across-the-Line Components	Transient Voltage Surge Suppressors	Accessories and Parts for Electronic Equipment	Varistors for Use in Electronic Equipment
Symbols	◆	●	▲	■
File Number	E223034	E223033	220978	40006997

‡ For UL 1449 (2nd Edition), the maximum clamping voltage is measured at 500A.

Figure V18-V19 H Series Specifications – 7mm Devices
Pulse Lifetime Ratings and V-I Characteristic Curves

Figure V18 - ROV07H180M-ROV07H680K

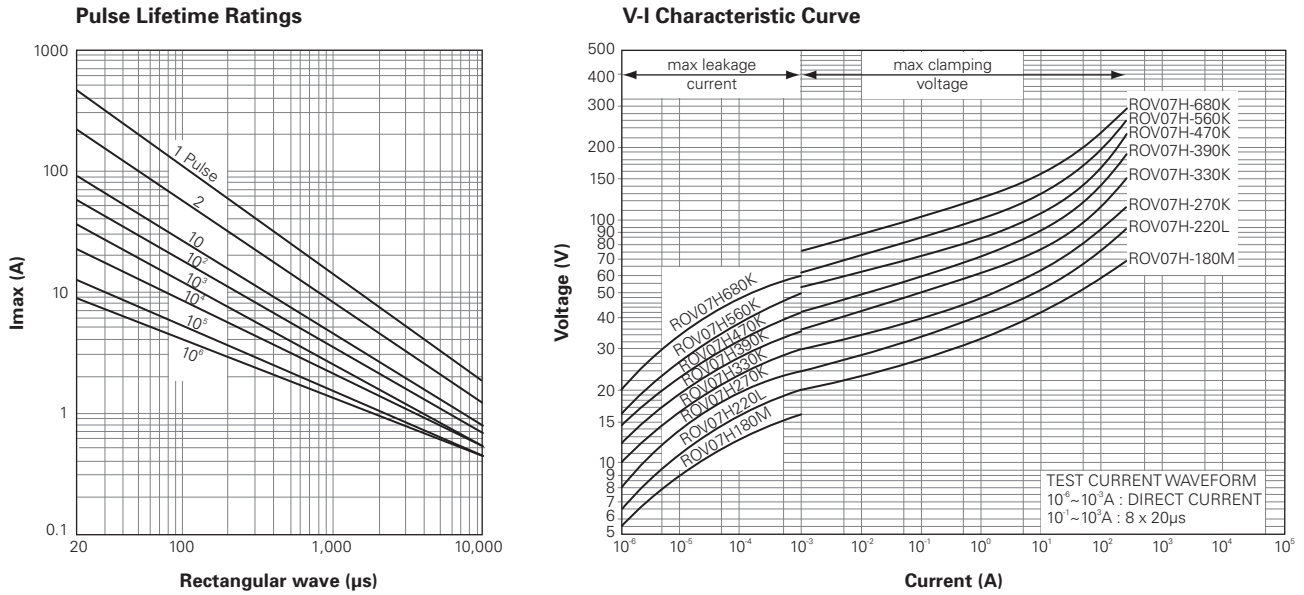

Figure V19 - ROV07H820K-ROV07H471K

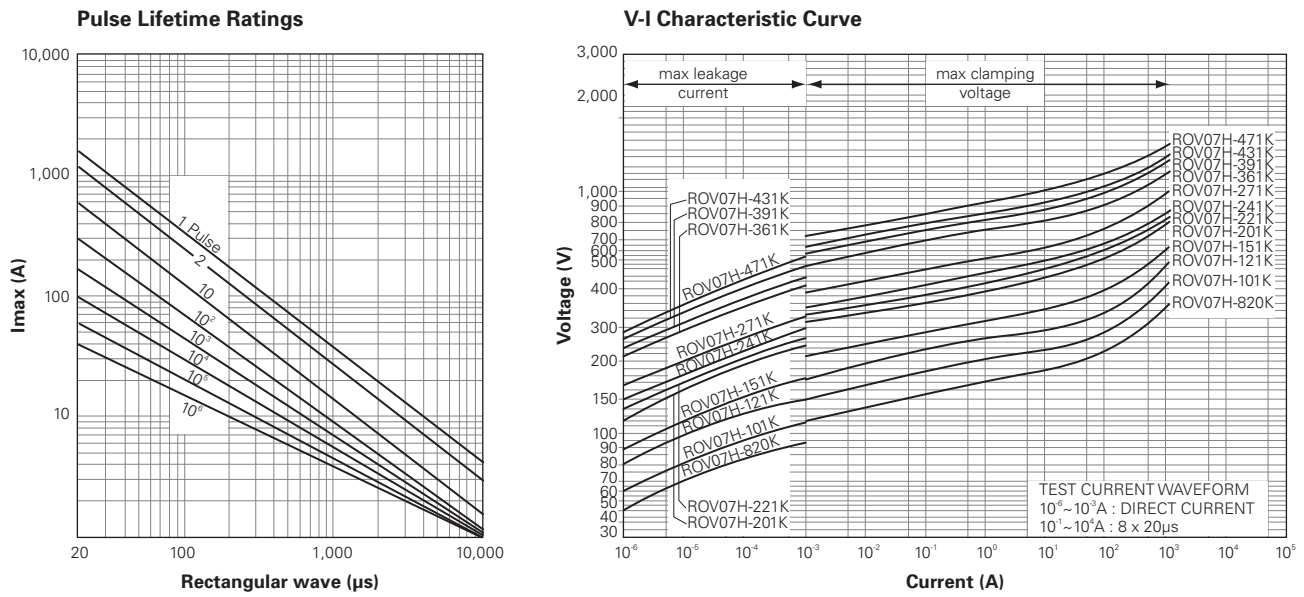

Table V11 Rating and Characteristics for H Series Specifications – 10mm Devices

Part Number	Varistor Voltage V@1.0mA		Maximum Allowance Voltage		Maximum Clamping Voltage	Maximum Surge Current (8x20µs)		Rated Woltage (W)	Energy (10x1000µs) (J)	Capacitance (Typical) (pF)	Certification†
	DC (V)	Tolerance	AC (V _{RMS})	DC (V)	V@25A (V)	1 Time (A)	2 Times (A)				
ROV10H180M	18	±20%	11	14	36*	1000	500	0.05	2.6	6500	● ■
ROV10H220L	22	±15%	14	18	43*	1000	500	0.05	3.2	5520	● ■
ROV10H270K	27	±10%	17	22	53*	1000	500	0.05	3.9	4740	● ■
ROV10H330K	33	±10%	20	26	65*	1000	500	0.05	4.8	4250	● ■
ROV10H390K	39	±10%	25	31	77*	1000	500	0.05	5.6	3660	● ■
ROV10H470K	47	±10%	30	38	93*	1000	500	0.05	6.8	3140	● ■
ROV10H560K	56	±10%	35	45	110*	1000	500	0.05	8.1	2900	● ■
ROV10H680K	68	±10%	40	56	135*	1000	500	0.05	9.8	2230	● ■
ROV10H820K	82	±10%	50	65	135	3500	2500	0.40	14.0	1260	● ■
ROV10H101K	100	±10%	60	85	165	3500	2500	0.40	18.0	1020	● ■
ROV10H121K	120	±10%	75	100	200	3500	2500	0.40	22.0	950	● ■
ROV10H151K	150	±10%	95	125	250	3500	2500	0.40	25.0	730	● ■
ROV10H181K	180	±10%	115	150	300	3500	2500	0.40	32.0	480	● ■
ROV10H201K	200	±10%	130	170	340	3500	2500	0.40	35.0	400	◆ ● ▲ ■
ROV10H221K	220	±10%	140	180	360	3500	2500	0.40	39.0	390	◆ ● ▲ ■
ROV10H241K	240	±10%	150	200	395	3500	2500	0.40	42.0	330	◆ ● ▲ ■
ROV10H271K	270	±10%	175	225	455	3500	2500	0.40	49.0	330	◆ ● ▲ ■
ROV10H301K	300	±10%	195	250	505	3500	2500	0.40	52.0	280	◆ ● ▲ ■
ROV10H331K	330	±10%	210	275	550	3500	2500	0.40	58.0	280	◆ ● ▲ ■
ROV10H361K	360	±10%	230	300	595	3500	2500	0.40	65.0	230	◆ ● ▲ ■
ROV10H391K	390	±10%	250	320	650	3500	2500	0.40	70.0	250	◆ ● ▲ ■
ROV10H431K	430	±10%	275	350	710	3500	2500	0.40	80.0	220	◆ ● ▲ ■
ROV10H471K	470	±10%	300	385	775	3500	2500	0.40	85.0	210	◆ ● ▲ ■
ROV10H511K	510	±10%	320	418	842	3500	2500	0.40	92.0	190	◆ ● ▲ ■
ROV10H561K	560	±10%	350	460	920	3500	2500	0.40	102.0	190	◆ ● ▲ ■
ROV10H621K	620	±10%	385	505	1025	3500	2500	0.40	107.0	160	◆ ● ▲ ■
ROV10H681K	680	±10%	420	560	1120	3500	2500	0.40	112.0	160	◆ ● ▲ ■
ROV10H751K	750	±10%	460	615	1240	3500	2500	0.40	115.0	130	◆ ● ▲ ■
ROV10H781K	780	±10%	485	640	1290	3500	2500	0.40	116.0	120	◆ ● ▲ ■
ROV10H821K	820	±10%	510	670	1355	3500	2500	0.40	118.0	130	◆ ● ▲ ■
ROV10H911K	910	±10%	550	745	1500	3500	2500	0.40	127.0	110	◆ ● ▲ ■
ROV10H102K	1000	±10%	625	825	1650	3500	2500	0.40	140.0	95	◆ ● ▲ ■
ROV10H112K	1100	±10%	680	895	1815	3500	2500	0.40	155.0	90	◆ ● ▲ ■
ROV10H182K	1800	±10%	1000	1465	2970	3500	2500	0.40	247.0	62	◆ ● ▲ ■

* The clamping voltages from 180M to 680K are tested at 5A current.

† Certification

Standard	UL1414‡	UL1449 (2nd Edition)‡	CSA	VDE
Title	Across-the-Line Components	Transient Voltage Surge Suppressors	Accessories and Parts for Electronic Equipment	Varistors for Use in Electronic Equipment
Symbols	◆	●	▲	■
File Number	E223034	E223033	220978	40006997

‡ For UL 1449 (2nd Edition), the maximum clamping voltage is measured at 500A.

Figure V20-V22 H Series Specifications – 10mm Devices
Pulse Lifetime Ratings and V-I Characteristic Curves

Figure V20 - ROV10H180M-ROV10H680K

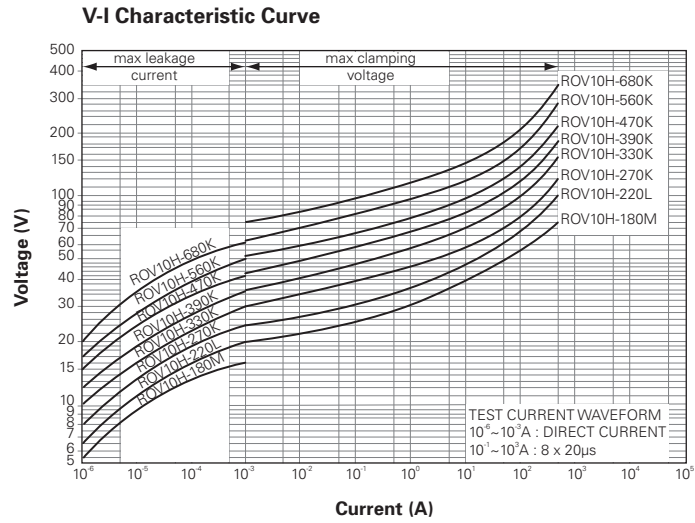
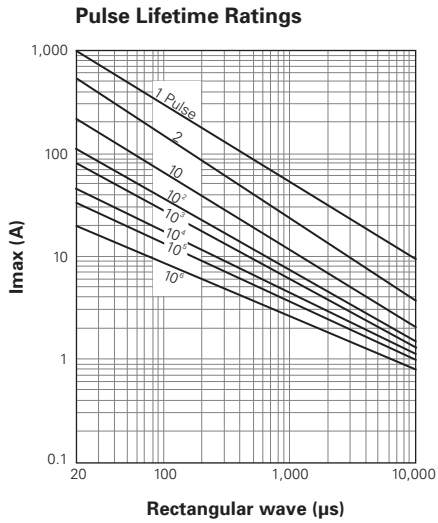

Figure V21 - ROV10H820K-ROV10H511K

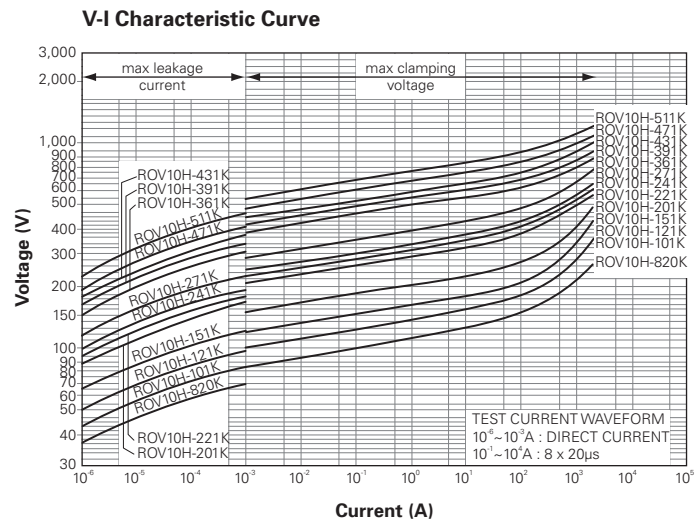
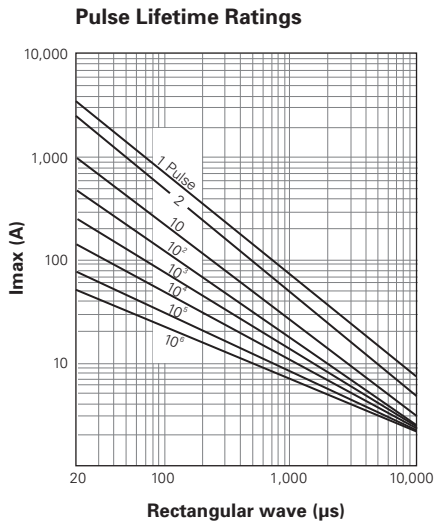

Figure V22 - ROV10H561K-ROV10H182K

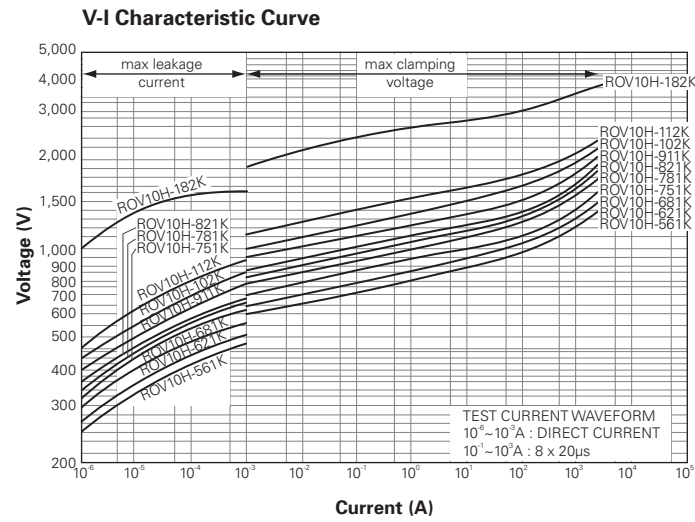
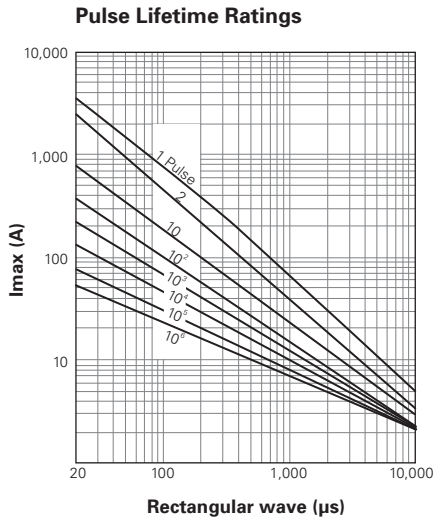

Table V12 Rating and Characteristics for H Series Specifications – 14mm Devices

Part Number	Varistor Voltage V@1.0mA		Maximum Allowance Voltage		Maximum Clamping Voltage	Maximum Surge Current (8x20µs)		Rated Woltage (W)	Energy (10x1000µs) (J)	Capacitance (Typical) (pF)	Certification†
	DC (V)	Tolerance	AC (V _{RMS})	DC (V)	V@50A (V)	1 Time (A)	2 Times (A)				
ROV14H180M	18	±20%	11	14	36*	2000	1000	0.1	5.2	14890	● ■
ROV14H220L	22	±15%	14	18	43*	2000	1000	0.1	6.3	11960	● ■
ROV14H270K	27	±10%	17	22	53*	2000	1000	0.1	7.8	9730	● ■
ROV14H330K	33	±10%	20	26	65*	2000	1000	0.1	9.5	7700	● ■
ROV14H390K	39	±10%	25	31	77*	2000	1000	0.1	11.0	7620	● ■
ROV14H470K	47	±10%	30	38	93*	2000	1000	0.1	14.0	6420	● ■
ROV14H560K	56	±10%	35	45	110*	2000	1000	0.1	16.0	5180	● ■
ROV14H680K	68	±10%	40	56	135*	2000	1000	0.1	20.0	5100	● ■
ROV14H820K	82	±10%	50	65	135	6000	4500	0.6	28.0	2970	● ■
ROV14H101K	100	±10%	60	85	165	6000	4500	0.6	36.0	2220	● ■
ROV14H121K	120	±10%	75	100	200	6000	4500	0.6	44.0	1740	● ■
ROV14H151K	150	±10%	95	125	250	6000	4500	0.6	53.0	1510	● ■
ROV14H181K	180	±10%	115	150	300	6000	4500	0.6	65.0	920	● ■
ROV14H201K	200	±10%	130	170	340	6000	4500	0.6	70.0	840	◆ ● ▲ ■
ROV14H221K	220	±10%	140	180	360	6000	4500	0.6	78.0	710	◆ ● ▲ ■
ROV14H241K	240	±10%	150	200	395	6000	4500	0.6	84.0	770	◆ ● ▲ ■
ROV14H271K	270	±10%	175	225	455	6000	4500	0.6	99.0	650	◆ ● ▲ ■
ROV14H301K	300	±10%	195	250	505	6000	4500	0.6	105.0	650	◆ ● ▲ ■
ROV14H331K	330	±10%	210	275	550	6000	4500	0.6	115.0	610	◆ ● ▲ ■
ROV14H361K	360	±10%	230	300	595	6000	4500	0.6	130.0	470	◆ ● ▲ ■
ROV14H391K	390	±10%	250	320	650	6000	4500	0.6	140.0	460	◆ ● ▲ ■
ROV14H431K	430	±10%	275	350	710	6000	4500	0.6	155.0	450	◆ ● ▲ ■
ROV14H471K	470	±10%	300	385	775	6000	4500	0.6	175.0	420	◆ ● ▲ ■
ROV14H511K	510	±10%	320	418	842	6000	4500	0.6	190.0	370	◆ ● ▲ ■
ROV14H561K	560	±10%	350	460	920	6000	4500	0.6	205.0	400	◆ ● ▲ ■
ROV14H621K	620	±10%	385	505	1025	6000	4500	0.6	215.0	300	◆ ● ▲ ■
ROV14H681K	680	±10%	420	560	1120	6000	4500	0.6	225.0	310	◆ ● ▲ ■
ROV14H751K	750	±10%	460	615	1240	6000	4500	0.6	230.0	270	◆ ● ▲ ■
ROV14H781K	780	±10%	485	640	1290	6000	4500	0.6	233.0	250	◆ ● ▲ ■
ROV14H821K	820	±10%	510	670	1355	6000	4500	0.6	235.0	260	◆ ● ▲ ■
ROV14H911K	910	±10%	550	745	1500	6000	4500	0.6	255.0	240	◆ ● ▲ ■
ROV14H102K	1000	±10%	625	825	1650	6000	4500	0.6	283.0	200	◆ ● ▲ ■
ROV14H112K	1100	±10%	680	895	1815	6000	4500	0.6	310.0	180	◆ ● ▲ ■
ROV14H182K	1800	±10%	1000	1465	2970	6000	4500	0.6	510.0	121	◆ ● ▲ ■

* The clamping voltages from 180M to 680K are tested at 10A current.

† Certification

Standard	UL1414‡	UL1449 (2nd Edition)‡	CSA	VDE
Title	Across-the-Line Components	Transient Voltage Surge Suppressors	Accessories and Parts for Electronic Equipment	Varistors for Use in Electronic Equipment
Symbols	◆	●	▲	■
File Number	E223034	E223033	220978	40006997

‡ For UL 1449 (2nd Edition), the maximum clamping voltage is measured at 500A.

Figure V23-V25 H Series Specifications – 14mm Devices
Pulse Lifetime Ratings and V-I Characteristic Curves

Figure V23 - ROV14H180M-ROV14H680K

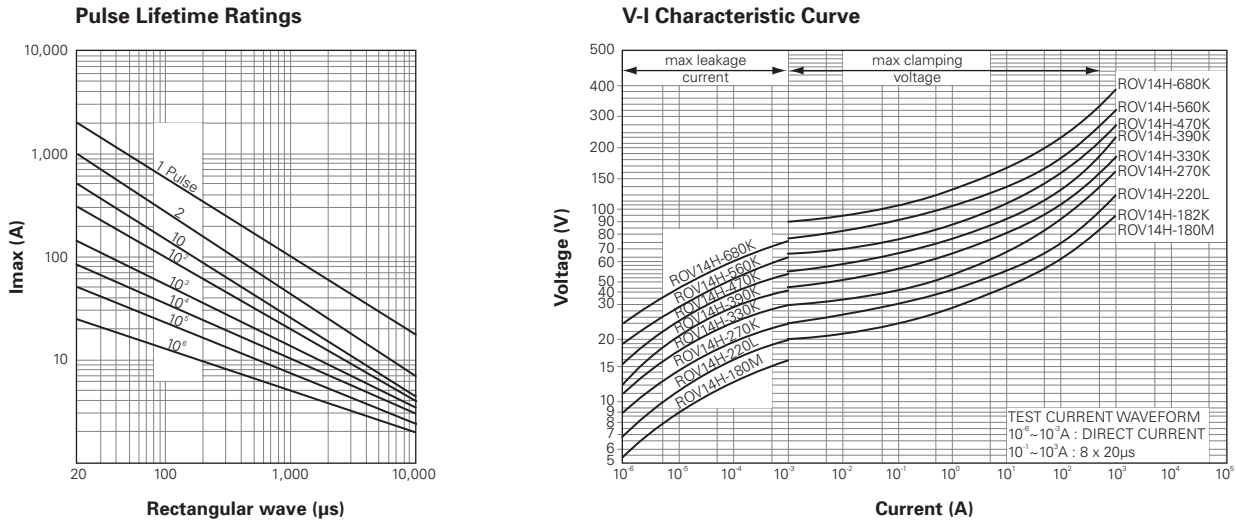

Figure V24 - ROV14H820K-ROV14H511K

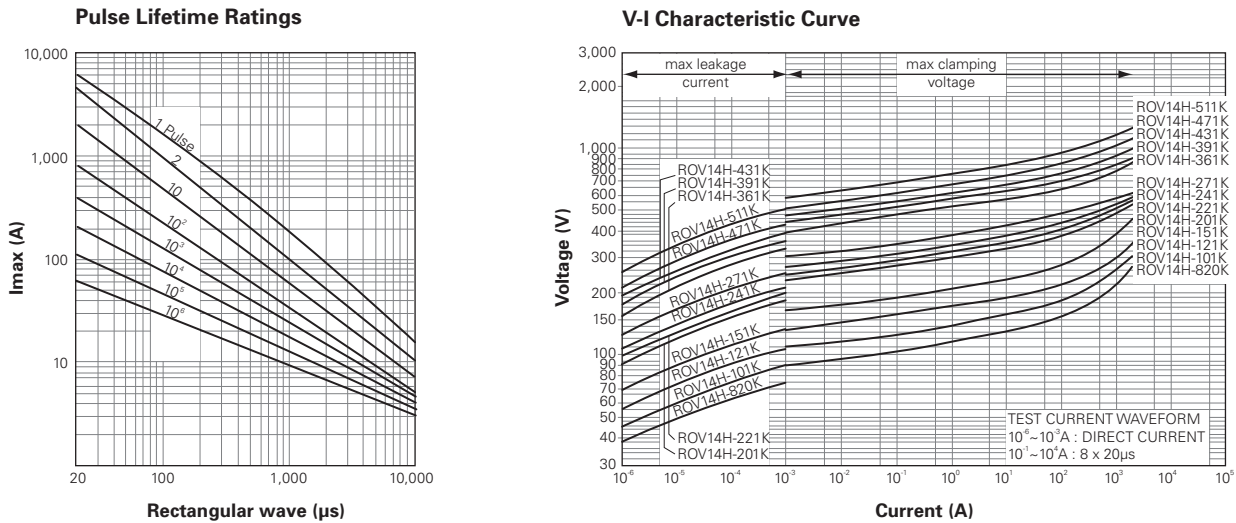

Figure V25 - ROV14H561K-ROV14H182K

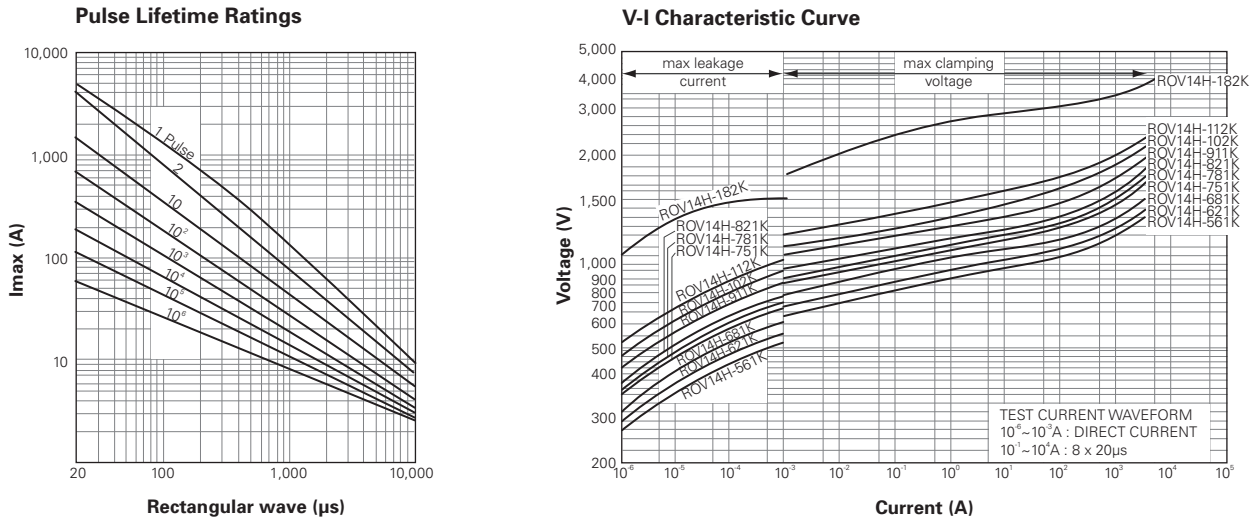

Table V13 Rating and Characteristics for H Series Specifications – 20mm Devices

Part Number	Varistor Voltage V@1.0mA		Maximum Allowance Voltage		Maximum Clamping Voltage	Maximum Surge Current (8x20µs)		Rated Woltage	Energy (10x1000µs)	Capacitance (Typical)	Certification†
	DC (V)	Tolerance	AC (V _{RMS})	DC (V)	V@100A (V)	1 Time (A)	2 Times (A)	(W)	(J)	(pF)	
ROV20H220M	22	±20%	14	18	43*	3000	2000	0.2	16.0	21200	● ■
ROV20H270M	27	±20%	17	22	53*	3000	2000	0.2	19.0	20000	● ■
ROV20H330M	33	±20%	20	26	65*	3000	2000	0.2	24.0	17200	● ■
ROV20H390L	39	±15%	25	31	77*	3000	2000	0.2	28.0	15000	● ■
ROV20H470L	47	±15%	30	38	93*	3000	2000	0.2	34.0	12100	● ■
ROV20H560L	56	±15%	35	45	110*	3000	2000	0.2	41.0	11600	● ■
ROV20H680L	68	±15%	40	56	135*	3000	2000	0.2	49.0	9600	● ■
ROV20H101K	100	±10%	60	85	165	10000	6500	1.0	72.0	4000	● ■
ROV20H121K	120	±10%	75	100	200	10000	6500	1.0	88.0	3800	● ■
ROV20H151K	150	±10%	95	125	250	10000	6500	1.0	106.0	3000	● ■
ROV20H181K	180	±10%	115	150	300	10000	6500	1.0	130.0	2400	● ■
ROV20H201K	200	±10%	130	170	340	10000	6500	1.0	140.0	1830	◆ ● ▲ ■
ROV20H221K	220	±10%	140	180	360	10000	6500	1.0	155.0	1600	◆ ● ▲ ■
ROV20H241K	240	±10%	150	200	395	10000	6500	1.0	168.0	1420	◆ ● ▲ ■
ROV20H271K	270	±10%	175	225	455	10000	6500	1.0	190.0	1260	◆ ● ▲ ■
ROV20H301K	300	±10%	195	250	505	10000	6500	1.0	210.0	1100	◆ ● ▲ ■
ROV20H331K	330	±10%	210	275	550	10000	6500	1.0	228.0	1110	◆ ● ▲ ■
ROV20H361K	360	±10%	230	300	595	10000	6500	1.0	255.0	990	◆ ● ▲ ■
ROV20H391K	390	±10%	250	320	650	10000	6500	1.0	275.0	980	◆ ● ▲ ■
ROV20H431K	430	±10%	275	350	710	10000	6500	1.0	303.0	860	◆ ● ▲ ■
ROV20H471K	470	±10%	300	385	775	10000	6500	1.0	350.0	760	◆ ● ▲ ■
ROV20H511K	510	±10%	320	418	842	10000	6500	1.0	382.0	790	◆ ● ▲ ■
ROV20H561K	560	±10%	350	460	920	10000	6500	1.0	410.0	680	◆ ● ▲ ■
ROV20H621K	620	±10%	385	505	1025	10000	6500	1.0	420.0	600	◆ ● ▲ ■
ROV20H681K	680	±10%	420	560	1120	10000	6500	1.0	430.0	550	◆ ● ▲ ■
ROV20H751K	750	±10%	460	615	1240	10000	6500	1.0	440.0	550	◆ ● ▲ ■
ROV20H781K	780	±10%	485	640	1290	10000	6500	1.0	450.0	480	◆ ● ▲ ■
ROV20H821K	820	±10%	510	670	1355	10000	6500	1.0	460.0	520	◆ ● ▲ ■
ROV20H911K	910	±10%	550	745	1500	10000	6500	1.0	510.0	440	◆ ● ▲ ■
ROV20H102K	1000	±10%	625	825	1650	10000	6500	1.0	566.0	400	◆ ● ▲ ■
ROV20H112K	1100	±10%	680	895	1815	10000	6500	1.0	620.0	360	◆ ● ▲ ■
ROV20H182K	1801	±11%	1000	1465	2970	10000	6500	1.0	1020.0	250	◆ ● ▲ ■

* The clamping voltages from 180M to 680K are tested at 20A current.

†Certification

Standard	UL1414‡	UL1449 (2nd Edition)‡	CSA	VDE
Title	Across-the-Line Components	Transient Voltage Surge Suppressors	Accessories and Parts for Electronic Equipment	Varistors for Use in Electronic Equipment
Symbols	◆	●	▲	■
File Number	E223034	E223033	220978	40006997

‡ For UL 1449 (2nd Edition), the maximum clamping voltage is measured at 500A.

Figure V26-V28 H Series Specifications – 20mm Devices
Pulse Lifetime Ratings and V-I Characteristic Curves

Figure V26 - ROV20H220M-ROV20H680L

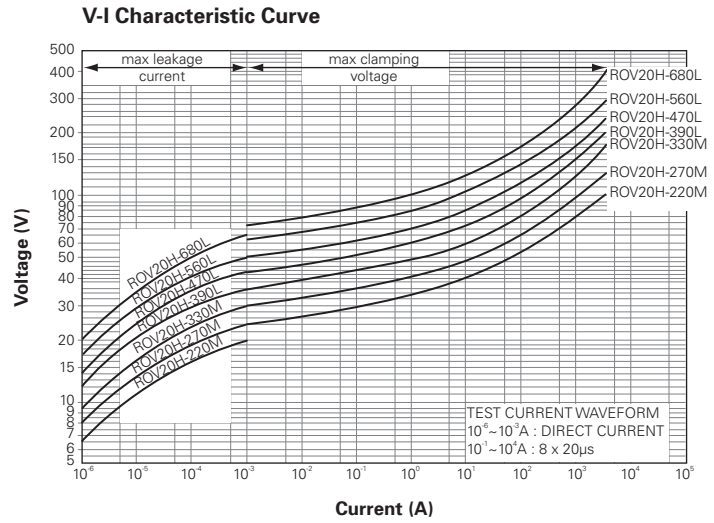
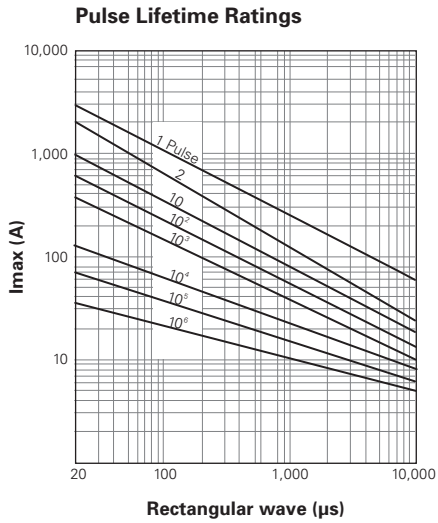

Figure V27 - ROV20H101K-ROV20H511K

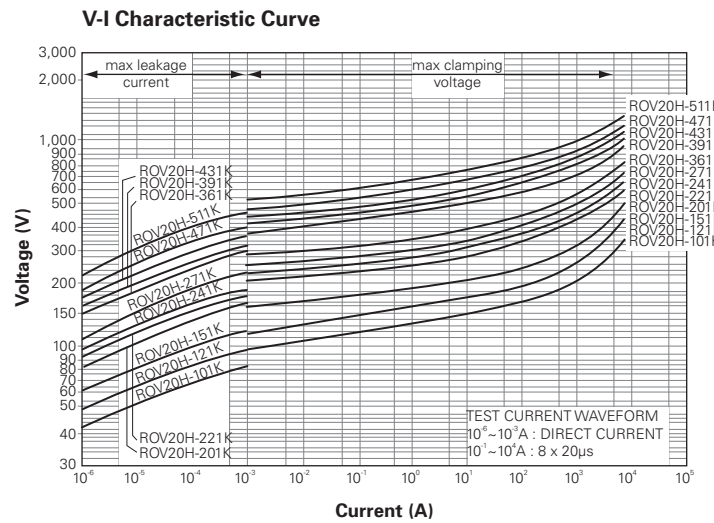
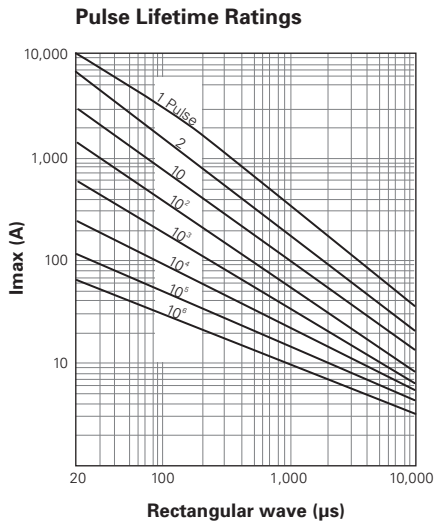

Figure V28 - ROV20H561K-ROV20H182K

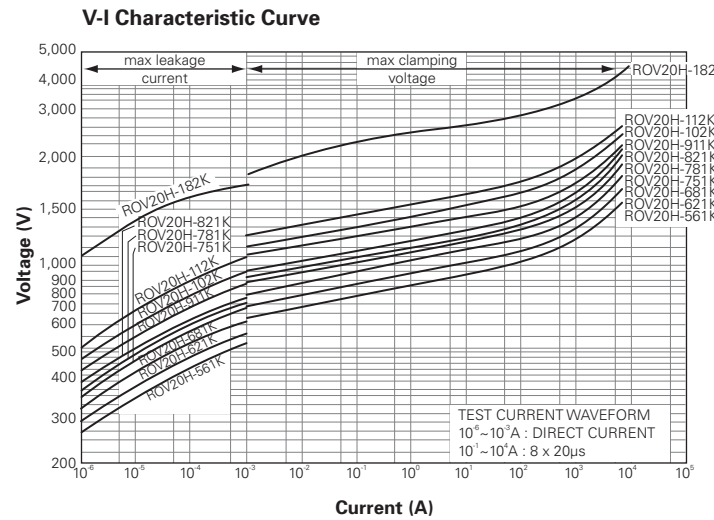
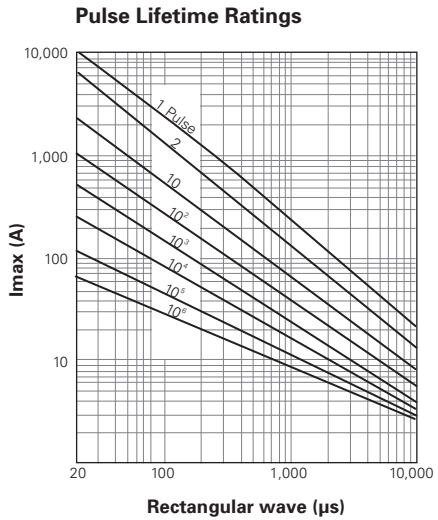

Table V14 Rating and Characteristics for E Series Specifications — 14mm Devices

Part Number	Varistor Voltage V@1.0mA		Maximum Allowance Voltage		Maximum Clamping Voltage	Maximum Surge Current (8x20µs)		Rated Woltage	Energy (10x1000µs)	Capacitance (Typical)	Certification†
	DC (V)	Tolerance	AC (V _{RMS})	DC (V)	V@50A (V)	1 Time (A)	2 Times (A)	(W)	(J)	(pF)	
ROV14E201K	200	±10%	130	170	340	6500	6000	0.6	84.0	840	●▲
ROV14E221K	220	±10%	140	180	360	6500	6000	0.6	93.0	710	●▲
ROV14E241K	240	±10%	150	200	395	6500	6000	0.6	101.0	770	●▲
ROV14E271K	270	±10%	175	225	455	6500	6000	0.6	113.0	—	—
ROV14E301K	300	±10%	195	250	505	6500	6000	0.6	126.0	—	—
ROV14E331K	330	±10%	210	275	550	6500	6000	0.6	138.0	—	—
ROV14E361K	360	±10%	230	300	595	6500	6000	0.6	151.0	—	—

Table V15 Rating and Characteristics for E Series Specifications — 20mm Devices

Part Number	Varistor Voltage V@1.0mA		Maximum Allowance Voltage		Maximum Clamping Voltage	Maximum Surge Current (8x20µs)		Rated Woltage	Energy (10x1000µs)	Capacitance (Typical)	Certification†
	DC (V)	Tolerance	AC (V _{RMS})	DC (V)	V@100A (V)	1 Time (A)	2 Times (A)	(W)	(J)	(pF)	
ROV20E201K	200	±10%	130	170	340	12500	10000	1.0	168.0	1830	●▲
ROV20E221K	220	±10%	140	180	360	12500	10000	1.0	186.0	1600	●▲
ROV20E241K	240	±10%	150	200	395	12500	10000	1.0	202.0	1420	●▲
ROV20E271K	270	±10%	175	225	455	12500	10000	1.0	227.0	—	—
ROV20E301K	300	±10%	195	250	505	12500	10000	1.0	252.0	—	—
ROV20E331K	330	±10%	210	275	550	12500	10000	1.0	277.0	—	—
ROV20E361K	360	±10%	230	300	595	12500	10000	1.0	302.0	—	—

†Certification

Standard	UL1414†	UL1449 (2nd Edition)†	CSA	VDE
Title	Across-the-Line Components	Transient Voltage Surge Suppressors	Accessories and Parts for Electronic Equipment	Varistors for Use in Electronic Equipment
Symbols	◆	●	▲	■
File Number	E223034	E223033	220978	40006997

† For UL 1449 (2nd Edition), the maximum clamping voltage is measured at 500A.

Mechanical and Environmental Tests for ROV Metal Oxide Varistors
Humidity

 The part is subjected to 40±2°C, 90 to 95% R.H. for 1000 hours without load and then stored at room temperature and ambient humidity for 1 to 2 hours. The change of V_B, (ΔV_B), is then measured and must meet the requirement of ΔV_B/V_B ≤ ± 5%, where V_B is the initial value.

Impulse Life

 The maximum surge current (8 x 20µs) listed in this catalog is applied 1000 times continuously with an interval of 30 seconds at room temperature. The change of V_B, (ΔV_B), is then measured and must meet the requirement of ΔV_B/V_B ≤ ± 10%, where V_B is the initial value.

Low-Temperature Storage

 The part is subjected to -40±2°C without load for 1000 hours and then stored at room temperature and ambient humidity for 1 to 2 hours. The change of V_B, (ΔV_B), is then measured and must meet the requirement of ΔV_B/V_B ≤ ± 5%, where V_B is the initial value.

High-Temperature Load

 After the Maximum Allowable Voltage is applied at 85±2°C for 1000 hours, the part is stored at room temperature and ambient humidity for 1 to 2 hours. The change of V_B, (ΔV_B), is then measured and must meet the requirement of ΔV_B/V_B ≤ ± 10%, where V_B is the initial value.

High-Temperature Storage

 The part is subjected to 125±2°C for 1000 hours in a drying oven without load and then stored at room temperature and ambient humidity for 1 to 2 hours. The change of V_B, (ΔV_B), is then measured and must meet the requirement of ΔV_B/V_B ≤ ± 5%, where V_B is the initial value.

Mechanical and Environmental Tests for ROV Metal Oxide Varistors

... Cont'd

Maximum Voltage

The specified voltage is applied between the terminals of the part for 1 minute. No mechanical damage should be noticeable.

	Test Voltage (AC)
Dielectric Withstand	2500 _{VRMS}

Terminal Pull Strength

After gradually applying the load specified below and keeping the unit fixed for 10 ± 1 s, no mechanical damage should be noticeable.

Terminal Diameter	Loading Weight in Pull Strength
0.6mm	10N (1.02Kg)
0.8mm	10N (1.02Kg)
1.0mm	20N (2.04Kg)

Terminal Bending Strength

The device is secured with one terminal in vertical position and the weight specified below is applied to the other terminal. The terminal is gradually bent by 90° in one direction, then 90° in the opposite direction and again back to the original position. This is repeated two times. No mechanical damage should be noticeable.

Terminal Diameter	Loading Weight in Pull Strength
0.6mm	5N (0.51Kg)
0.8mm	5N (0.51Kg)
1.0mm	10N (1.02Kg)

Vibration

The device is subjected to a simple harmonic motion of 0.75mm amplitude with 1.5mm maximum total excursion between limits. A 10-55Hz frequency scan is traversed in 1 minute. This motion is applied for a period of 2 hours in each of 3 mutually perpendicular directions. No mechanical damage should be noticeable.

Solderability

After dipping the terminal to a depth of approximately 3mm from the body in a soldering bath of $235 \pm 5^\circ\text{C}$ for 2 ± 0.5 s, the terminal is visually examined. Approximately 95% of the terminals should be uniformly covered with new solder.

Resistance to Soldering Heat

The terminal is dipped into a soldering bath with a temperature of $260 \pm 5^\circ\text{C}$ to a point of 2~2.5mm from the body of the unit. It is held there for 10 ± 1 s (5 Standard series: 5 ± 1 s) and then stored at room temperature and normal humidity for 1 to 2 hours. The change of V_B , ($\Delta V_B/B$), is then measured and must meet the requirement of $\Delta V_B/V_B \leq \pm 5\%$, (where V_B is the initial value) with no noticeable mechanical damage.

Damp Heat Load

The device is subjected to $40 \pm 2^\circ\text{C}$, 90 to 95% R.H. and the maximum allowable voltage for 1000 hours and then stored at room temperature and ambient humidity for 1 to 2 hours. The change of V_B , ($\Delta V_B/B$), is then measured and must meet the requirement of $\Delta V_B/V_B \leq 10\%$, where V_B is the initial value.

Temperature Cycle

The following temperature cycle is repeated 5 times:

1. $-40 \pm 3^\circ\text{C}$ for 30 ± 3 minutes
2. Room temperature for 15 ± 3 minutes
3. $125 \pm 2^\circ\text{C}$ for 30 ± 3 minute.
4. Room temperature for 15 ± 3 minutes

Afterwards, the part is stored at room temperature and ambient humidity for 1 to 2 hours. The change of V_B , ($\Delta V_B/B$), is then measured and must meet the requirement of $\Delta V_B/V_B \leq \pm 5\%$, (where V_B is the initial value) with no noticeable mechanical damage.

Figure V29-V30 Marking and Packaging Specifications for ROV Metal Oxide Varistors

Figure V29 - Marking

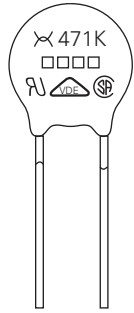

✕ : Manufacturer's mark
 471 : Varistor Voltage Indicator
 K : Varistor Voltage Tolerance
 □□□□ : Lot Identification

Figure V30 - Packaging in Millimeters

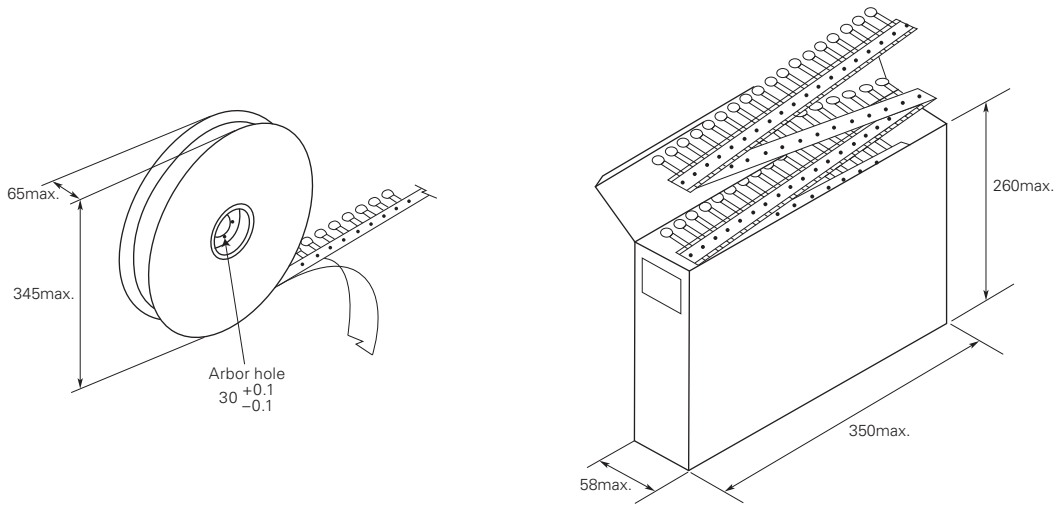

Table V16 Packaging Quantity in Pieces for ROV Metal Oxide Varistors

Part Number	Series														
	5mm			7mm			10mm			14mm			20mm		
	Bulk (Box)	Reel	Ammo	Bulk (Box)	Reel	Ammo	Bulk (Box)	Reel	Ammo	Bulk (Box)	Reel	Ammo	Bulk (Box)	Reel	Ammo
180M	5000	1500	1500	5000	1500	1500	2500	1000	500	1500	750	500	—	—	—
220M~470K	5000	1500	1500	5000	1500	1500	2500	1000	500	1500	750	500	150	500	500
560K~680K	5000	1500	1000	5000	1500	1000	2500	1000	500	1500	750	500	150	500	500
820K	5000	1500	1500	5000	1500	1500	2500	1000	500	1500	750	500	—	—	—
101K~331K	5000	1500	1500	5000	1500	1500	2500	1000	500	1500	750	500	150	500	500
360K~391K	5000	1500	1000	5000	1500	1000	2500	1000	500	1500	750	500	150	500	500
431K~471K	5000	1500	1000	5000	1000	1000	2000	750	500	1500	750	500	150	500	500
511K~681K	4000	1000	1000	4000	1000	1000	1500	500	500	750	500	500	150	500	500
751K	4000	1000	1000	4000	1000	1000	1500	500	500	750	500	500	150	—	—
781K~911K	—	—	—	—	—	—	1500	500	500	750	500	500	150	—	—
911K~112K	—	—	—	—	—	—	1500	500	500	750	—	—	150	—	—
182K	—	—	—	—	—	—	750	—	—	450	—	—	75	—	—

Packaging	Bulk (box)	Reel	Reel (14mm, 20mm)	Ammo (5mm, 7mm)	Ammo (10mm, 14mm) 180K-471K	Ammo (10mm, 14mm) 471K-751K	Ammo (20mm) 180K-751K
Box size (mm)	290 x 155 x 110	350 x 350 x 108	350 x 350 x 74	330 x 240 x 46	343 x 210 x 52	343 x 260 x 52	343 x 220 x 58
Carton size (mm)	310 x 328 x 250	371 x 371 x 590	370 x 370 x 468	350 x 500 x 270	363 x 440 x 250	363 x 540 x 250	363 x 460 x 250
One carton with	4 Boxes	5 Boxes (10 reels)	6 Boxes (6 reels)	10 Boxes	8 Boxes	8 Boxes	8 Boxes

Part Numbering System for ROV Metal Oxide Varistors

ROV 14 — 220 L -S -10 1 -2

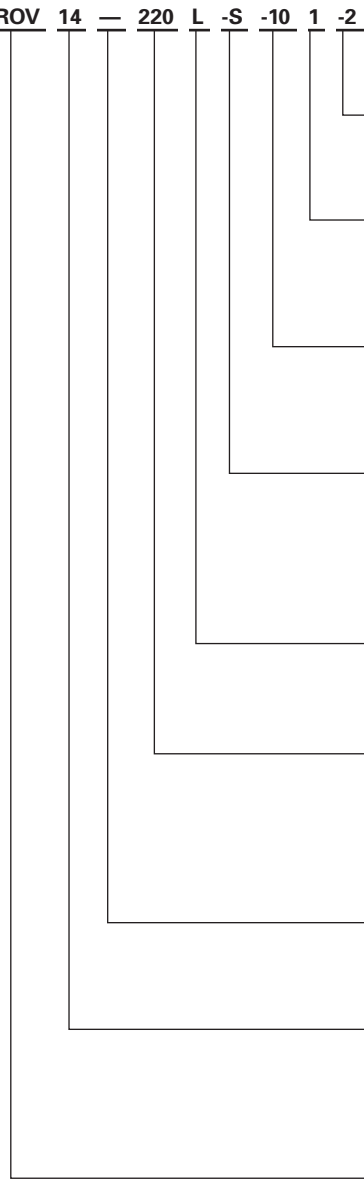

Packaging

No suffix = Bulk
 -2 = Tape & reel
 -AP= Ammo pack

Lead Diameter

No suffix = standard diameter
 6 = 0.6mm
 8 = 0.8mm
 1 = 1.0mm

Lead Spacing

No suffix = standard spacing
 -5 = 5mm
 -7 = 7.5mm
 -10 = 10mm

Lead Configuration

No suffix = Kinked lead
 -S = Straight lead
 -A = Inside crimp "Type A"
 -B = Inside crimp "Type B"
 -C = Outside crimp "Type C"
 -D = Outside crimp "Type D"

Varistor Voltage Tolerance

K = ±10%
 L = ±15%
 M = ±20%

Varistor Voltage Indicator

The first two digits indicate voltage.
 The third digit signifies the power of ten.
 For example:
 220: $22 \times 10^0 = 22V$
 221: $22 \times 10^1 = 220V$
 112: $11 \times 10^2 = 1100V$

Surge Series

— = Standard series (Standard surge series)
 H = H series (High surge series)
 E = E series (Extra surge series)

Diameter of Disc

05 = 5mm
 07 = 7mm
 10 = 10mm
 14 = 14mm
 20 = 20mm

Manufacturer Series



Warning :

- Operation beyond the maximum ratings or improper use may result in device damage and possible electrical arcing and flame.
- The devices are intended for protection against damage caused by occasional overvoltage fault conditions and should not be used when repeated fault conditions or prolonged trip events are anticipated.
- Device performance can be impacted negatively if devices are handled in a manner inconsistent with recommended electronic, thermal, and mechanical procedures for electronic components.

