

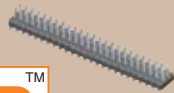

(1,00mm) .03937"

FTMH, FTM SERIES

FTM-125-02-L-DV



FTMH-116-02-L-DV-P



FTMH-111-02-F-DV-ES-A



SMT MICRO TERMINIAL STRIPS

SPECIFICATIONS

For complete specifications and recommended PCB layouts see www.samtec.com?FTMH or www.samtec.com?FTM

Insulator Material: Black Liquid Crystal Polymer



Terminal Material: Phosphor Bronze

Current Rating:

FTMH = 2.5A @ 80°C ambient

FTM = 1.5A @ 80°C ambient

Operating Temp Range:

-55°C to +125°C

Plating:

Sn or Au over

50µ" (1,27µm) Ni

RoHS Compliant:

Yes

Processing:

Lead-Free Solderable:

Yes

-DV Lead Coplanarity:

(0,10mm) .004" max

-DH Lead Coplanarity:

(0,10mm) .004" max (05-25)

(0,15mm) .006" max (26-50)

Mates with:
CLM, MLE

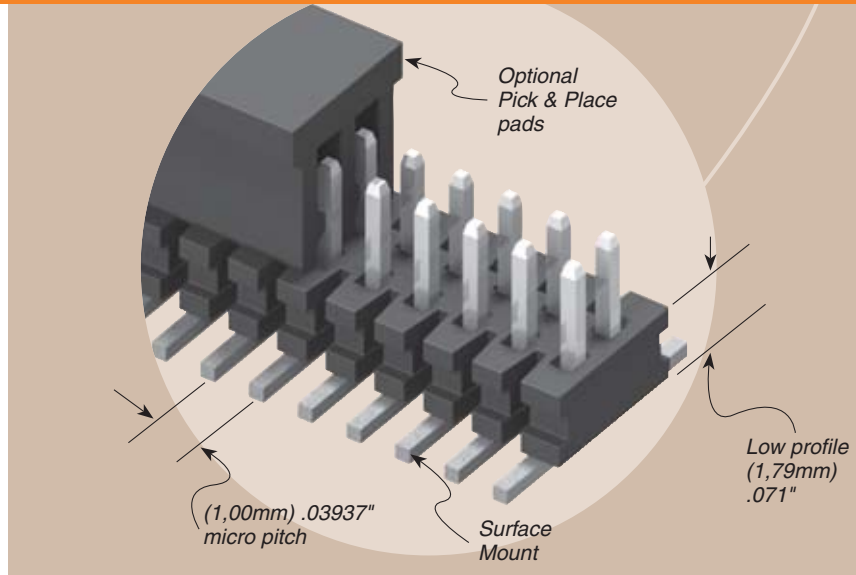

APPLICATION SPECIFIC OPTION

End shrouds with board locks available. Molded end shrouds available for 05 through 08 positions. Call Samtec.

TYPE STRIP

1

NO. PINS PER ROW

LEAD STYLE

PLATING OPTION

FTMH
= SMT Micro

FTM
= Micro Low Profile

FTMH & FTM
= 02 thru 50
(FTMH -DH Row Option)
(FTM except -S & -SA option 04 thru 46)

FTMH
= 05 thru 50
(-DV Row Option)

-02
= (1,91) .075" Post
(Mates with MLE)

-03
= (1,65) .065" Post
(Mates with CLM)

-F
= Gold flash on post,
Matte Tin on tail

-L
= 10µ" (0,25µm) Gold on post,
Matte Tin on tail

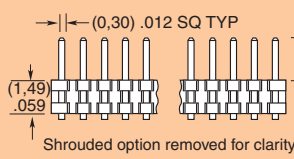
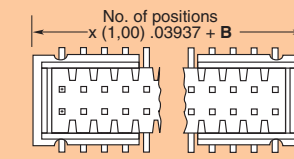
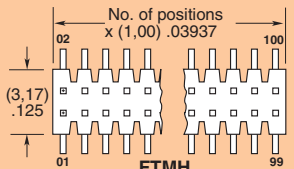

FTMH	
OPTION	B
-ES	(1,57) .062
-EC	(4,06) .160
-EP	(5,49) .216

FTMH	
LEAD STYLE	A
-02	(1,91) .075
-03	(1,65) .065

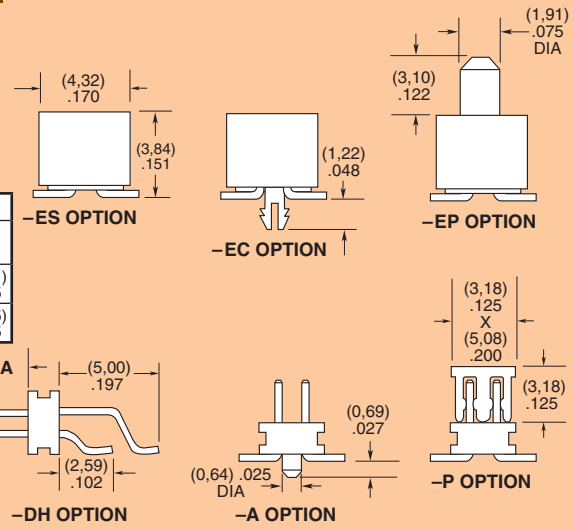

-DV OPTION

-DH OPTION

-A OPTION

-P OPTION

Note: Some lengths, styles and options are non-standard, non-returnable.

Due to technical progress, all designs, specifications and components are subject to change without notice.

WWW.SAMTEC.COM

FTMH-122-02-F-DV-EC

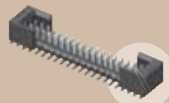

FTMH-120-02-L-DV



FTMH-135-02-F-DH



FTM-125-02-DV



FTMH-128-02-L-DV-EP

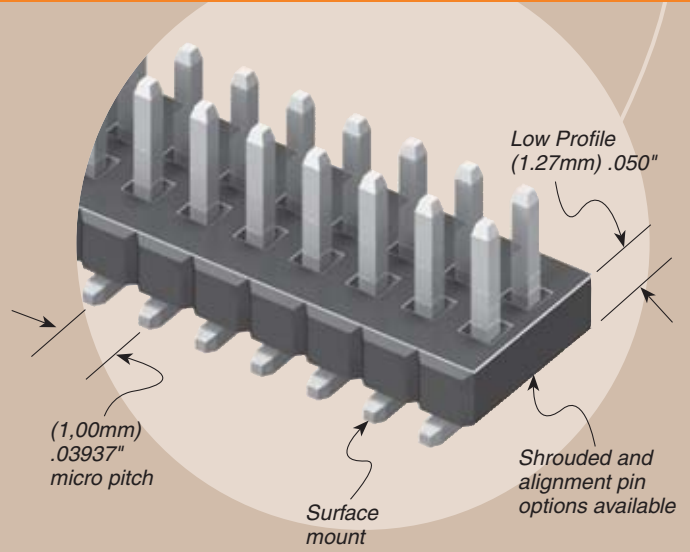
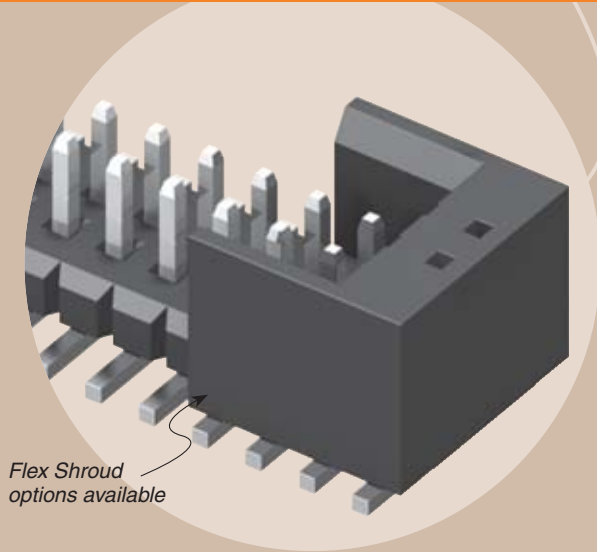
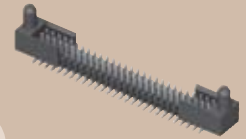

ROW OPTION

- DV = Dual Vertical
- DH = Dual Horizontal (FTMH only)

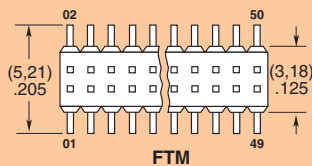

FTM

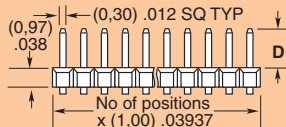
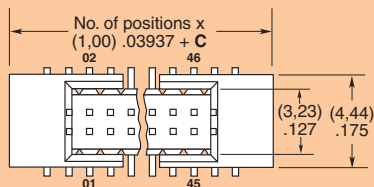

Shrouded options removed for clarity

FLEX SHROUD OPTIONS

(FTMH-DV only with 9 pins/row minimum)

- ES = End Shroud
- EC = End Shroud with Locking Clip (Manual placement required)
- EP = End Shroud with Guide Post (Use only when mating with CLM)

(FTM only)

- S = End Shroud (05 positions minimum). Molded or press fit shroud at Samtec's discretion (See assembly print at www.samtec.com?FTM for dimensions)
- SA = End Shroud with Alignment Pins (05 through 46 positions)

FTM	
OPTION	C
-S	(7,00) .276
-SA	(4,00) .157

FTM	
LEAD STYLE	D
-02	(1,91) .075
-03	(1,65) .065

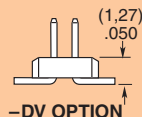

-DV OPTION

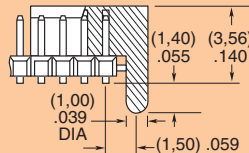

-SA OPTION

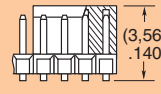

-S OPTION

OTHER OPTIONS

- A = Alignment Pin (3 positions minimum) Metal or plastic at Samtec discretion (FTMH-DV only)
- K = (2,50mm) .098" DIA Polyimide Film Pick & Place Pad (FTMH-DH only)
- P = Plastic Pick & Place Pad (-DV only) (6 positions minimum)
- TR = Tape & Reel

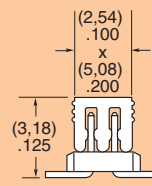

-P OPTION

Due to technical progress, all designs, specifications and components are subject to change without notice.

WWW.SAMTEC.COM