

# Bridge Rectifier

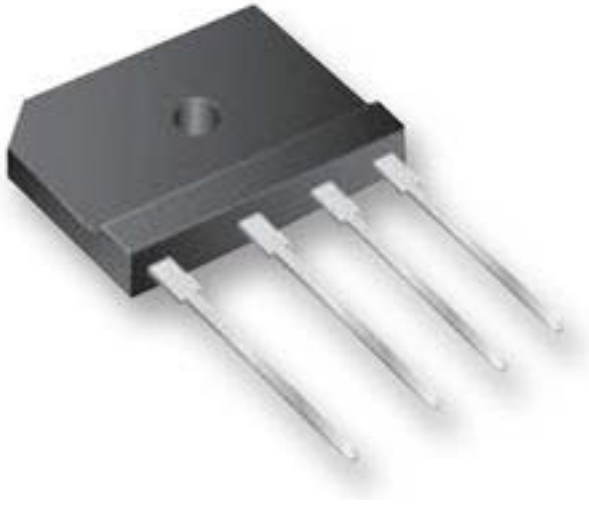

## Features:

- Glass passivated.
- Ideal for printed circuit board.
- Low forward voltage drop, high current capability.
- Reliable low cost construction utilizing moulded plastic technique results in inexpensive product.

Reverse Voltage - 100 V  
Forward Current - 15 Amperes

## GSIB

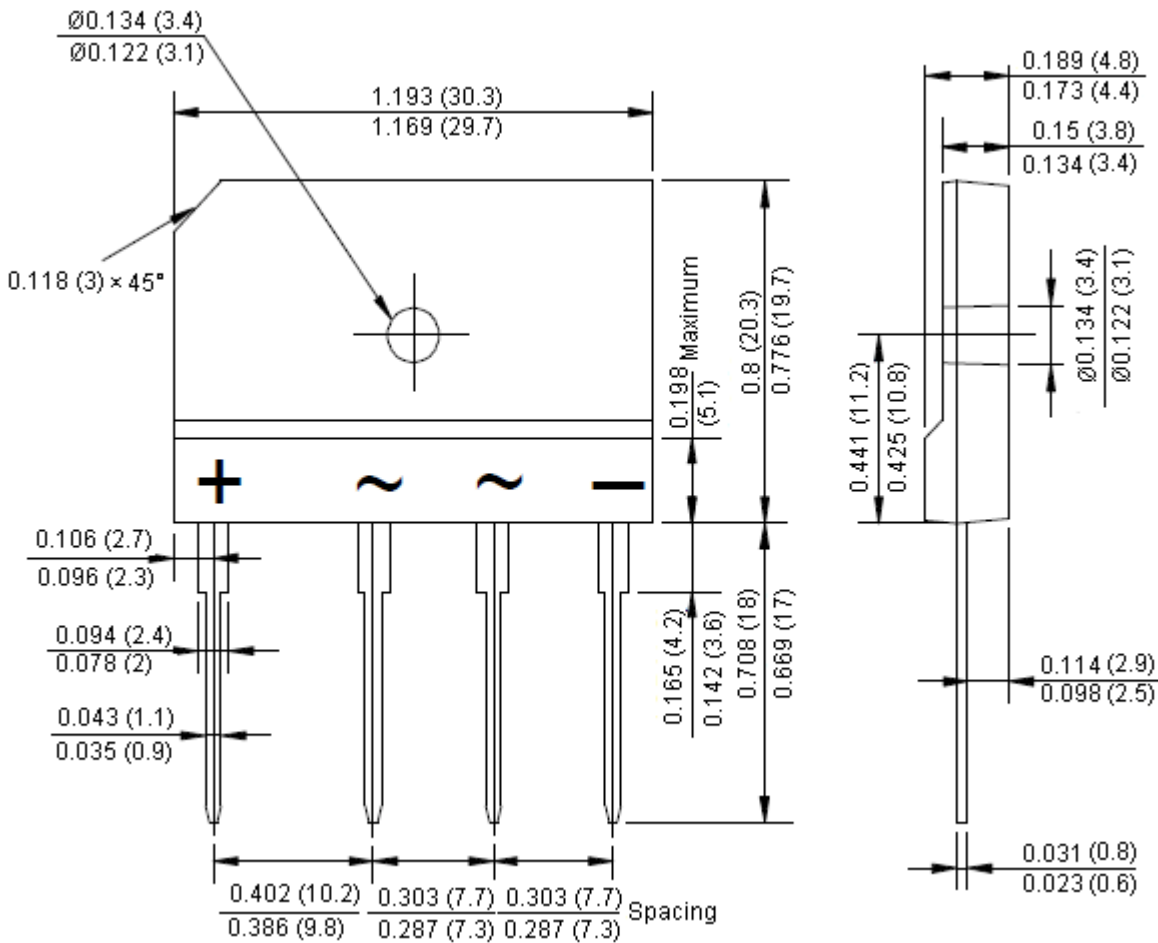

# Bridge Rectifier



## Maximum Ratings and Electrical Characteristics

Rating at 25°C ambient temperature unless otherwise specified.

Single phase, half wave, 60 Hz, resistive or inductive load.

For capacitive load, derate current by 20%.

Characteristics	Symbol	GSIB1501	Unit
Maximum Recurrent Peak Reverse Voltage	$V_{RRM}$	100	V
Maximum RMS Voltage	$V_{RMS}$	70	
Maximum DC Blocking Voltage	$V_{DC}$	100	
Maximum Average Forward (with heatsink Note 2) Rectified Current at $T_C = 100^\circ\text{C}$ (without heatsink)	$I_{(AV)}$	15 3.2	A
Peak Forward Surge Current 8.3 ms Single Half Sine-wave Super Imposed on Rated Load (JEDEC Method)	$I_{FSM}$	240	
Maximum Forward Voltage at 7.5 A dc	$V_F$	1.1	V
Maximum DC Reverse Current at $T_J = 25^\circ\text{C}$ at Rated DC Blocking Voltage at $T_J = 125^\circ\text{C}$	$I_R$	10 500	$\mu\text{A}$
$I^2t$ Rating for Fusing ( $t < 8.3$ ms)	$I^2t$	240	$\text{A}^2\text{s}$
Typical Junction Capacitance Per Element (Note1)	$C_J$	60	pF
Typical Thermal Resistance	$R_{\theta JC}$	0.8	$^\circ\text{C}/\text{W}$
Operating Temperature Range	$T_J$	-55 to +150	$^\circ\text{C}$
Storage Temperature Range	$T_{STG}$		

- Notes:** 1. Measured at 1 MHz and applied reverse voltage of 4 V dc.  
2. Device mounted on 300 × 300 × 1.6 mm Cu plate heatsink.

## Rating and Characteristics Curves

Forward Current Derating Curve

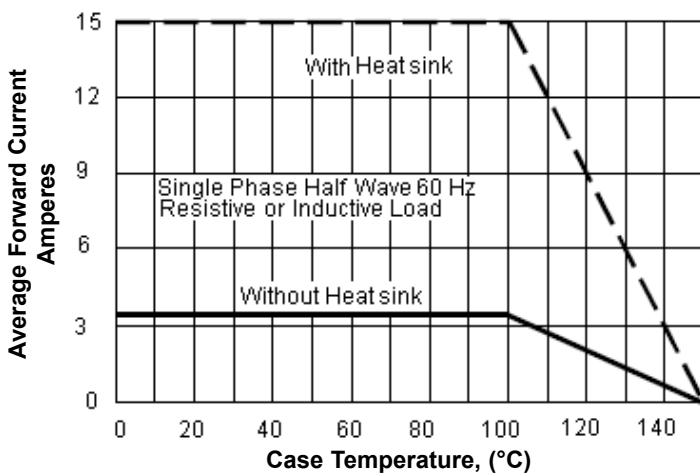

Maximum Non-Repetitive Surge Current

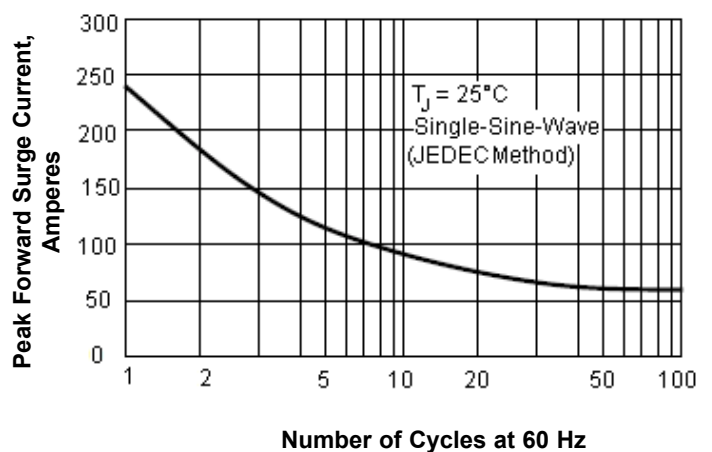

# Bridge Rectifier



## Rating and Characteristics Curves

Typical Junction Capacitance

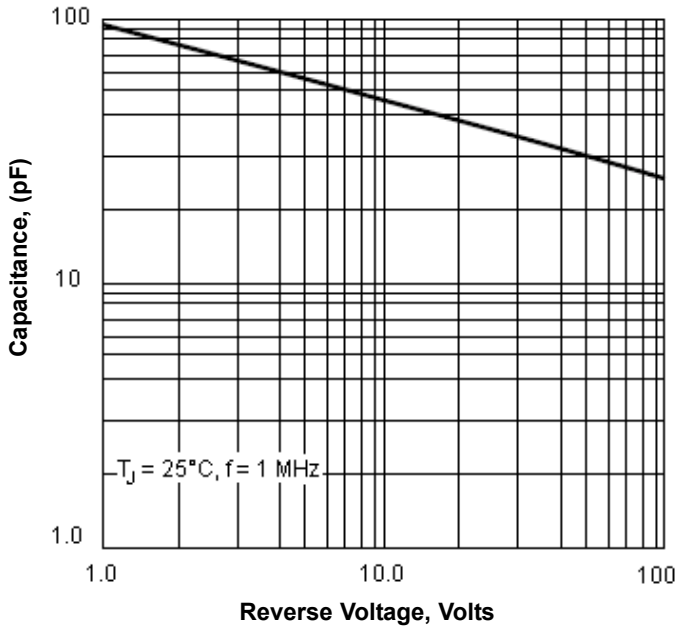

Typical Forward Characteristics

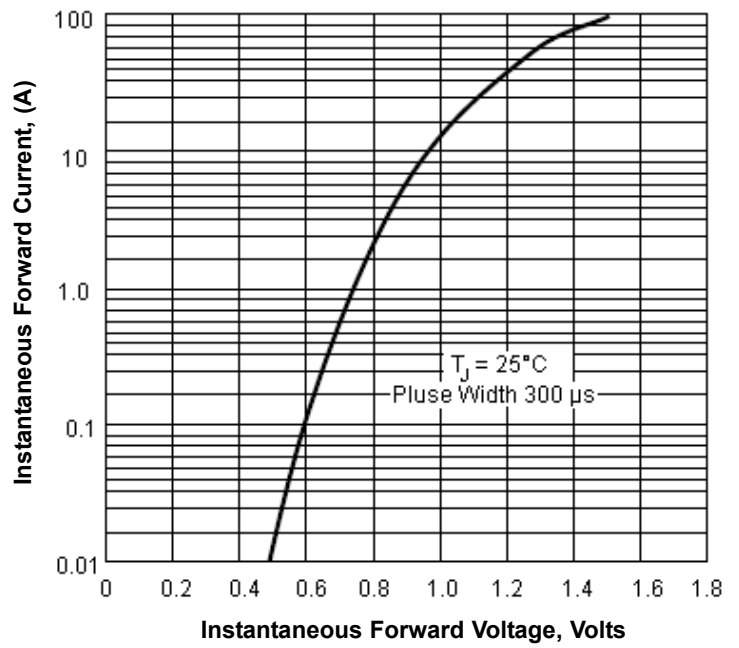

Typical Reverse Characteristics

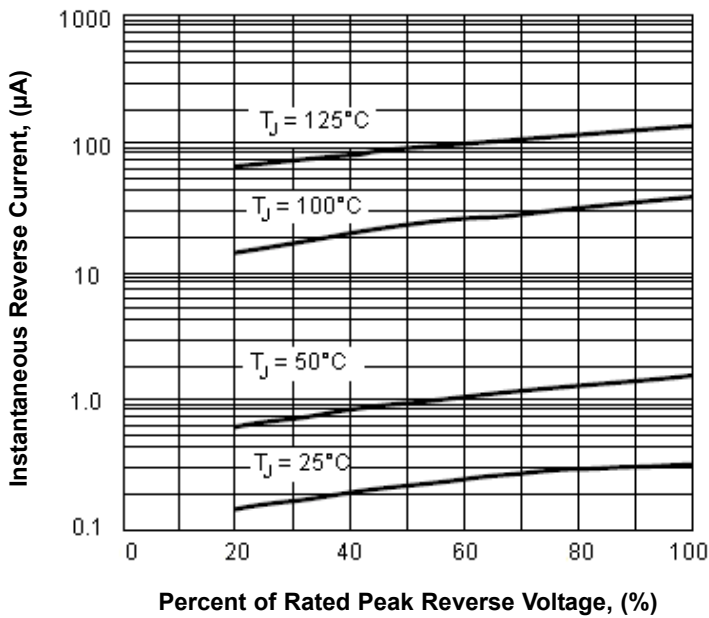

**Important Notice :** This data sheet and its contents (the "Information") belong to the members of the Premier Farnell group of companies (the "Group") or are licensed to it. No licence is granted for the use of it other than for information purposes in connection with the products to which it relates. No licence of any intellectual property rights is granted. The Information is subject to change without notice and replaces all data sheets previously supplied. The Information supplied is believed to be accurate but the Group assumes no responsibility for its accuracy or completeness, any error in or omission from it or for any use made of it. Users of this data sheet should check for themselves the Information and the suitability of the products for their purpose and not make any assumptions based on information included or omitted. Liability for loss or damage resulting from any reliance on the Information or use of it (including liability resulting from negligence or where the Group was aware of the possibility of such loss or damage arising) is excluded. This will not operate to limit or restrict the Group's liability for death or personal injury resulting from its negligence. Multicomp is the registered trademark of the Group. © Premier Farnell plc 2011.