



**Ordering number** FA11113  
**Description** FA11113\_LOST-W

Family	Leila	FWHM	degrees
Type	Assembly	Efficiency	-
LED	Ostar Lighting+	cd/lm	-
Color	Black	Gerber File	Available
Diameter	21.6 mm		
Height	13.2 mm		
Style	Round		
Optic Material	PMMA		
Holder Material	PC		
Fastening	Tape		
Status	Ready		



**Ordering number** FA11463  
**Description** FA11463\_LOST-M2

Family	Leila	FWHM	degrees
Type	Assembly	Efficiency	-
LED	Ostar Lighting+	cd/lm	-
Color	Black	Gerber File	Available
Diameter	21.6 mm		
Height	13.2 mm		
Style	Round		
Optic Material	PMMA		
Holder Material	PC		
Fastening	Tape		
Status	Ready		



**Ordering number** FA11110  
**Description** FA11110\_LOST-D

Family	Leila	FWHM	25 degrees
Type	Assembly	Efficiency	89 %
LED	Ostar Lighting+	cd/lm	-
Color	Black	Gerber File	Available
Diameter	21.6 mm		
Height	13.2 mm		
Style	Round		
Optic Material	PMMA		
Holder Material	PC		
Fastening	Tape		
Status	Ready		



**Ordering number** FA11112  
**Description** FA11112\_LOST-M

Family	Leila	FWHM	30 degrees
Type	Assembly	Efficiency	88 %
LED	Ostar Lighting+	cd/lm	-
Color	Black	Gerber File	Available
Diameter	21.6 mm		
Height	13.2 mm		
Style	Round		
Optic Material	PMMA		
Holder Material	PC		
Fastening	Tape		
Status	Ready		



**Ordering number** FA11114  
**Description** FA11114\_LOST-O-90

Family	Leila	FWHM	36+24 degrees
Type	Assembly	Efficiency	85 %
LED	Ostar Lighting+	cd/lm	-
Color	Black	Gerber File	Available
Diameter	21.6 mm		
Height	13.2 mm		
Style	Round		
Optic Material	PMMA		
Holder Material	PC		
Fastening	Tape		
Status	Ready		



**Ordering number** FA11115  
**Description** FA11115\_LOST-REC

Family	Leila	FWHM	36+29 degrees
Type	Assembly	Efficiency	81 %
LED	Ostar Lighting+	cd/lm	-
Color	Black	Gerber File	Available
Diameter	21.6 mm		
Height	13.2 mm		
Style	Round		
Optic Material	PMMA		
Holder Material	PC		
Fastening	Tape		
Status	Ready		

**Ordering number** FA11893  
**Description** FA11893-LOST-WW

Family	Leila	FWHM	degrees
Type	Assembly	Efficiency	-
LED	Ostar Lighting+	cd/lm	-
Color	Black	Gerber File	Available
Diameter	21.6 mm		
Height	13.2 mm		
Style	Round		
Optic Material	PMMA		
Holder Material	PC		
Fastening	Tape		
Status	Ready		

**NOTE: The typical divergence will be changed by different color, chip size and chip position tolerance. The typical total divergence is the full angle measured where the luminous intensity is half of the peak value.**



## PRODUCT DATASHEET LOST series

### GENERAL INFORMATION

- Product series especially designed & optimized for Ostar Lighting+ series of LEDs.
- Special care taken to make light distribution as uniform as possible.
- Lens material optical grade PMMA with high UV and temperature resistance (105 degrees of Celcius / 220 degrees of Fahrenheit). Allows use of high current and temperature conditions.

Please find more information about used material from below:

[http://ledil.fi/sites/default/files/Documents/Technical/Material/PMMA%20N%20UL94\\_Yellow%20Card.pdf](http://ledil.fi/sites/default/files/Documents/Technical/Material/PMMA%20N%20UL94_Yellow%20Card.pdf)

<http://ledil.fi/sites/default/files/Documents/Technical/Material/PMMA%20N%20PLEXIGLAS-Datasheet.pdf>

- Optic holder molded by high quality PC material (120 dergees of Celcius / 248 degrees of Fahrenheit).

- Fastening to heat sink with a PU foam adhesive tape of automotive grade. Please find fastening details by clicking link: [http://www.ledil.com/datasheets/DataSheet\\_TAPE.pdf](http://www.ledil.com/datasheets/DataSheet_TAPE.pdf)

**NOTE 1: We advise customer to ensure the suitability and sufficiency of the bond in the end product. For example, mechanical stress, vibration and holes on the surface of the circuit board weaken the strength of the tape.**

**NOTE 2: Assembly to the surface must be made straight, so the tape bonds constant and balanced with fastening surface. Slanted assembly might cause unbalanced bond to the surface. All surfaces where tape is applied must be clean, dry and free from grease and dirt.**

**If cleaning of PCB surfaces is needed, please follow strictly the cleaning instructions of your LED manufacturer - this is important as cleaning shall under no circumstances damage LEDs or other electronics components on the PCB.**

**Further note that optical components shall not be cleaned with any chemicals - only micro fiber cloth may be used to remove fingerprints or other traces from handling.**

**CA11483\_LXP2-M & XP-E-HEW**

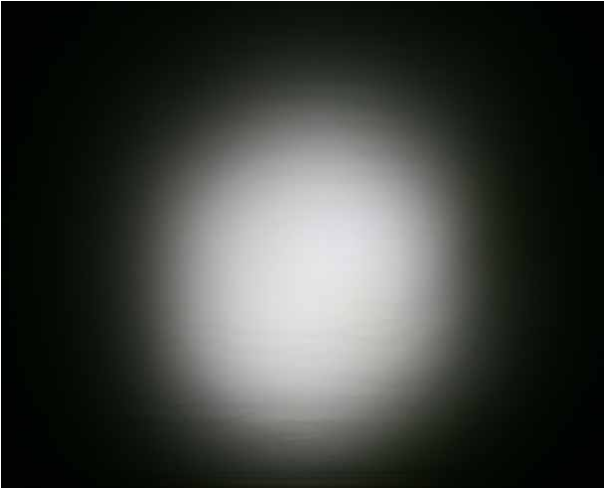

**CA11482\_LXP2-D**



**CA11481\_LXP2-RS**



**FA11116\_LXP-O-90**

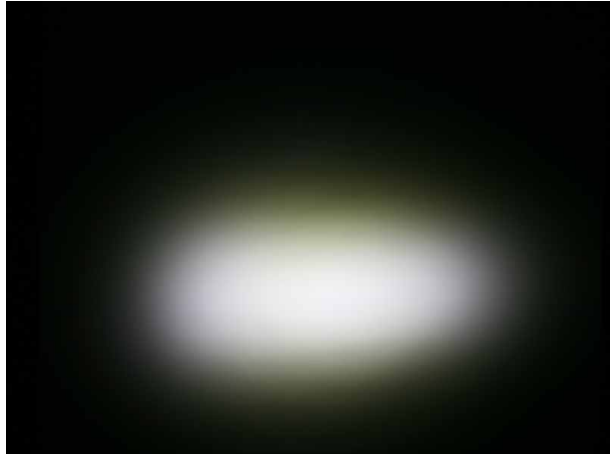

**FA10832\_LXP-W & XPE\_HEW**

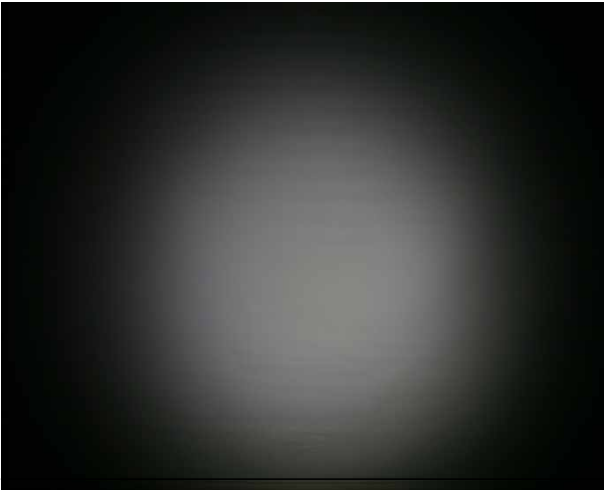

**FA10661\_LXP-RS**

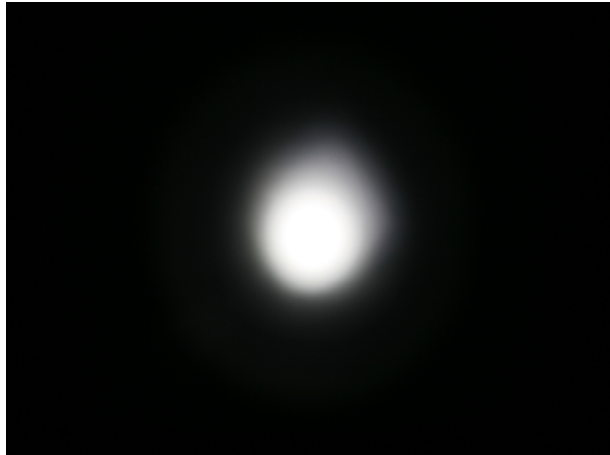



**FA10661\_LXP-RS & XP-E-HEW**

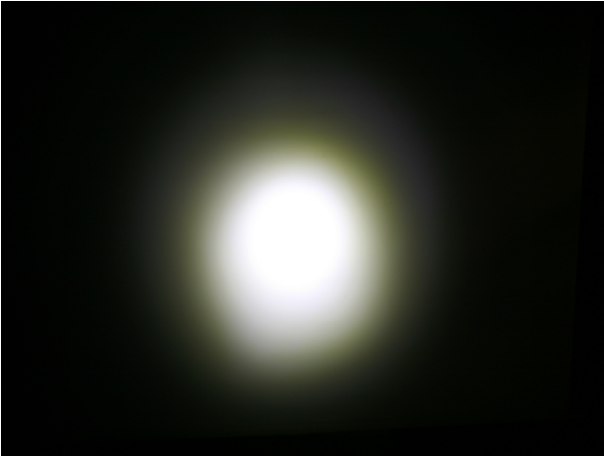

**CA11639\_LR2-M**

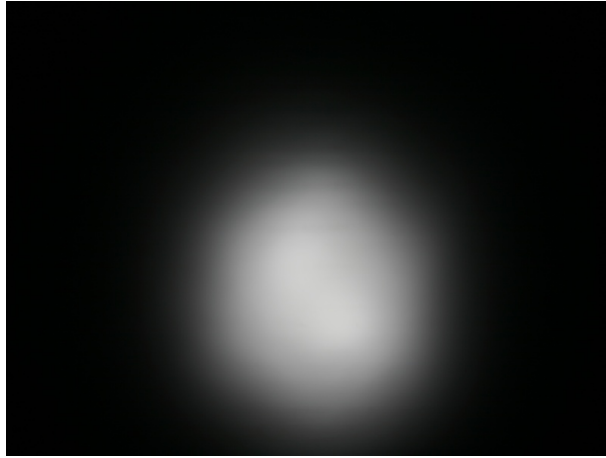

**CA11638\_LR2-D**



**CA11637\_LR2-RS**

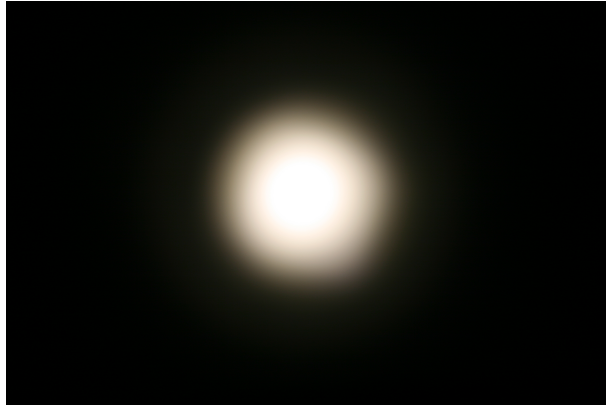

# Relative Intensity of CA11637\_LR2-RS

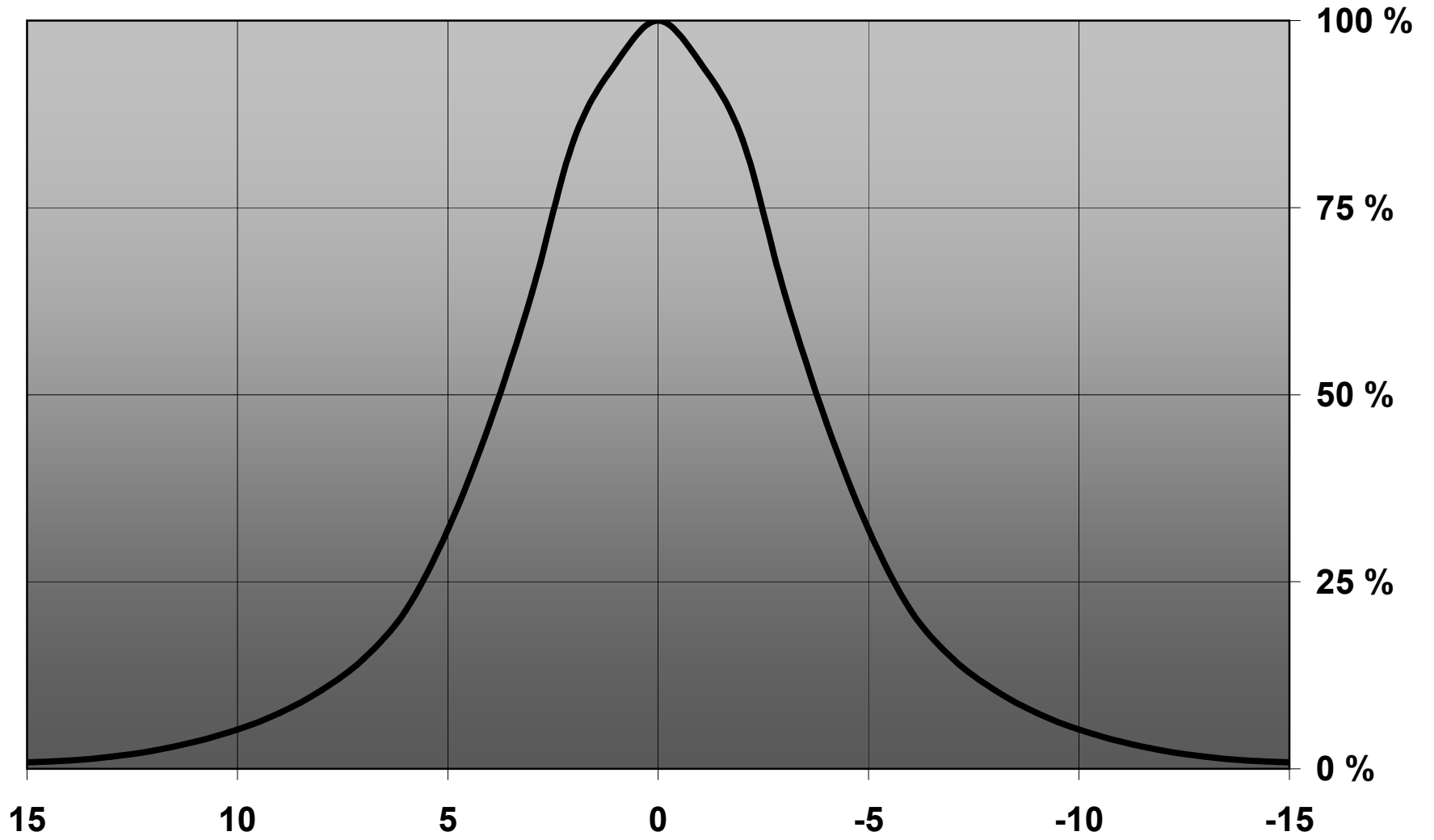

# Relative Intensity of CA11638\_LR2-D

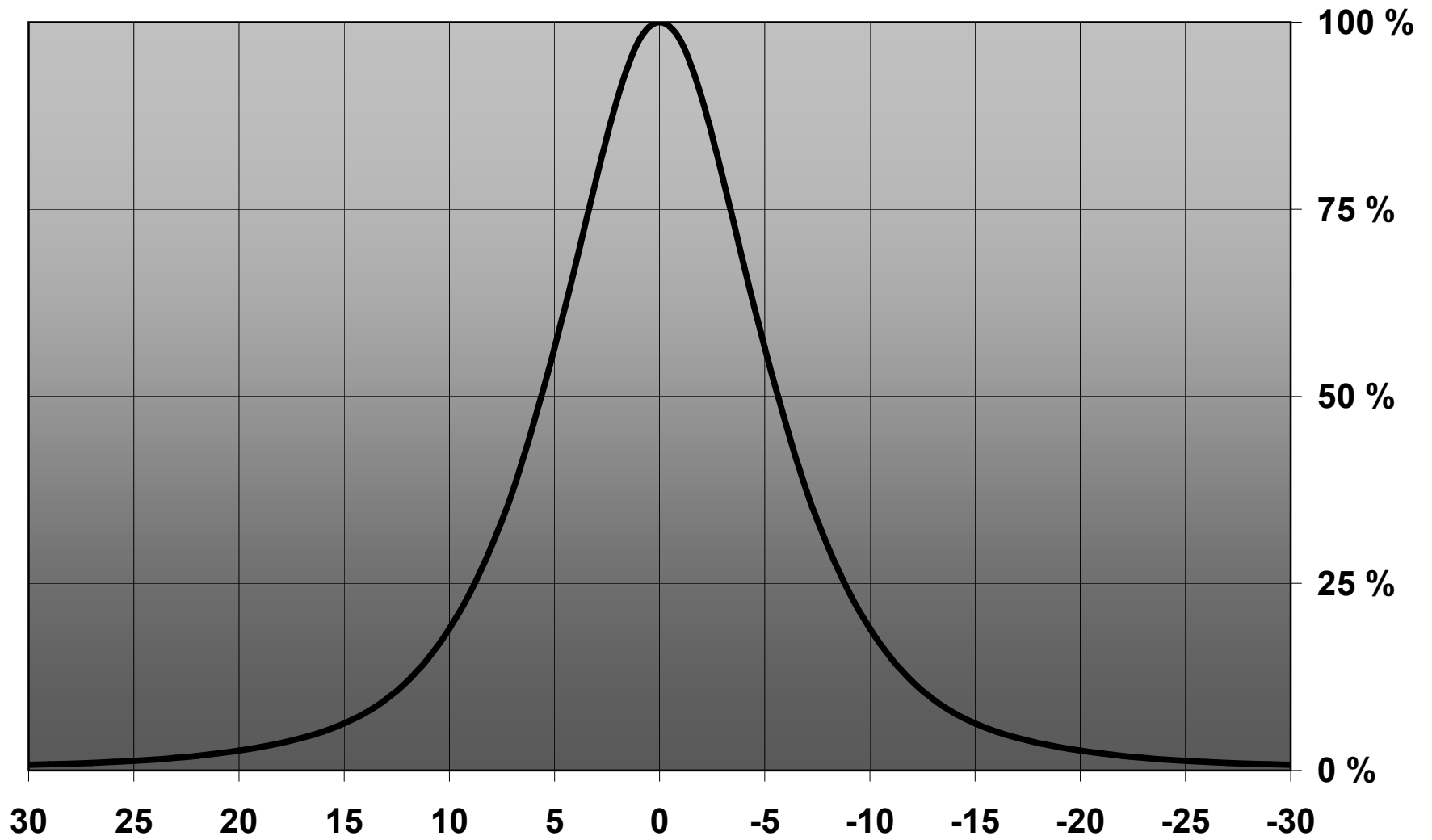

### Relative intensity of CA11639\_LR2-M

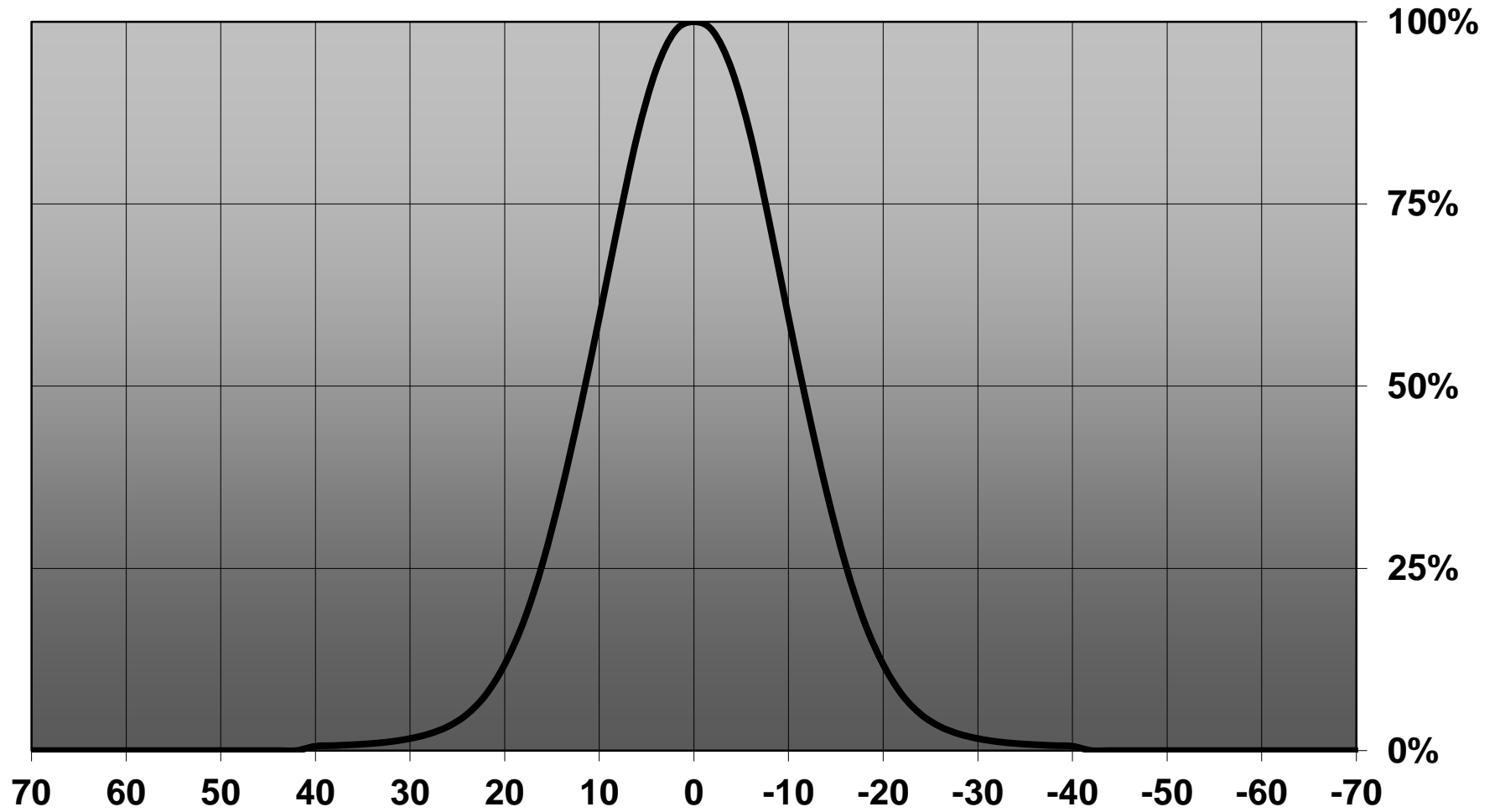

# Relative Intensity of FA10661\_LXP-RS-HEW

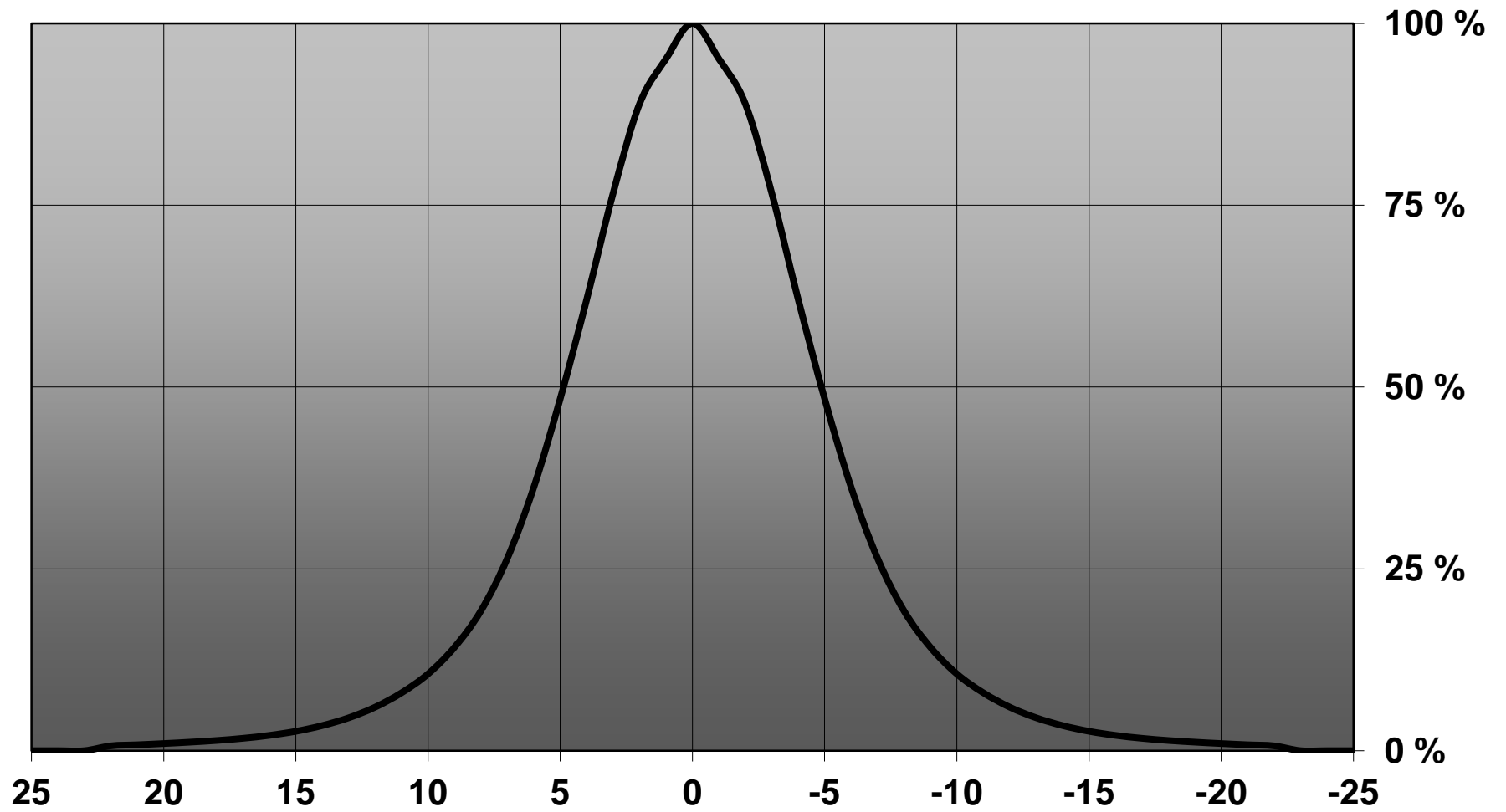



# Relative Intensity of FA10661\_LXP-RS

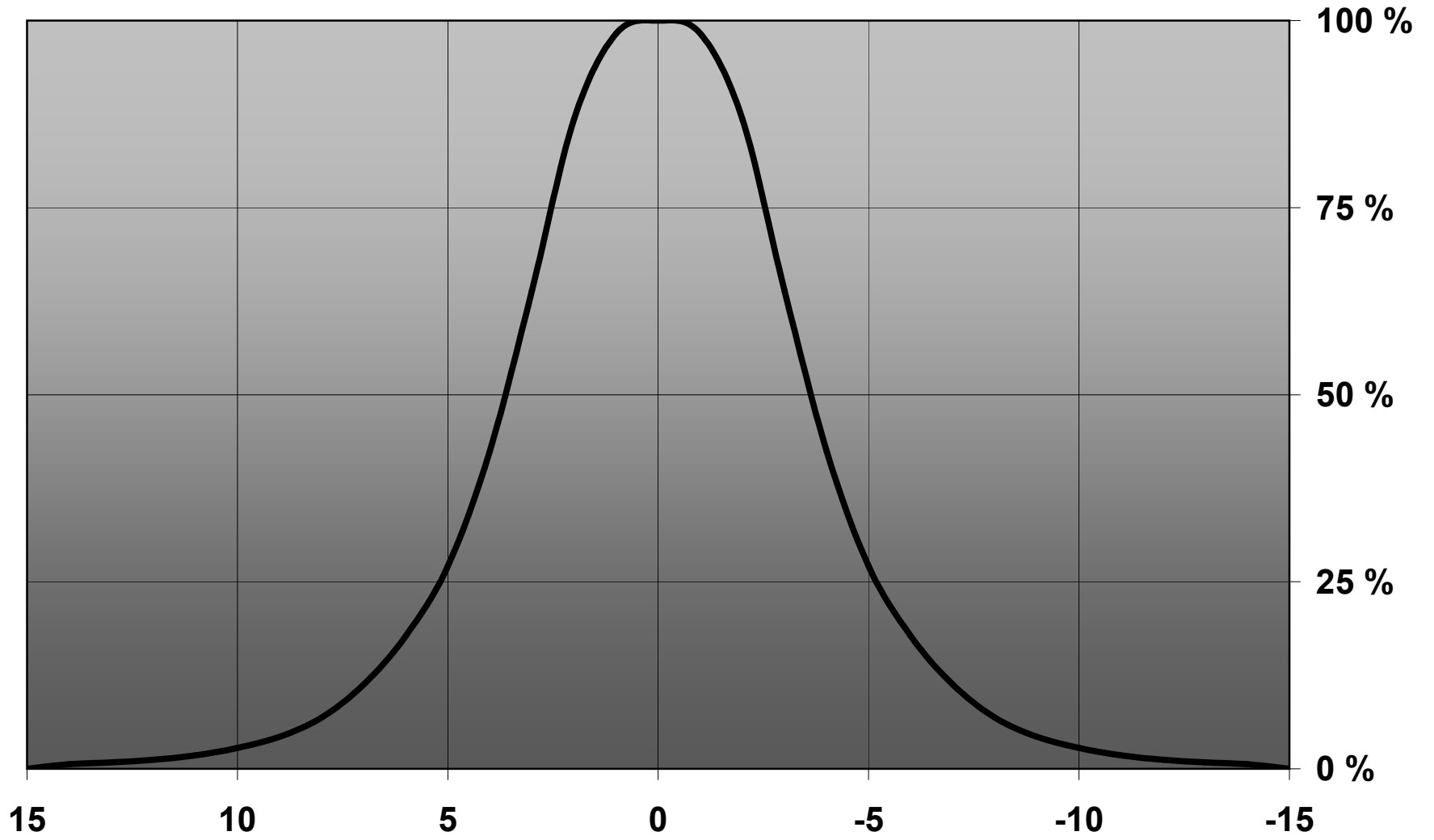

**Relative intensity of FA10832\_LXP-W-HEW**

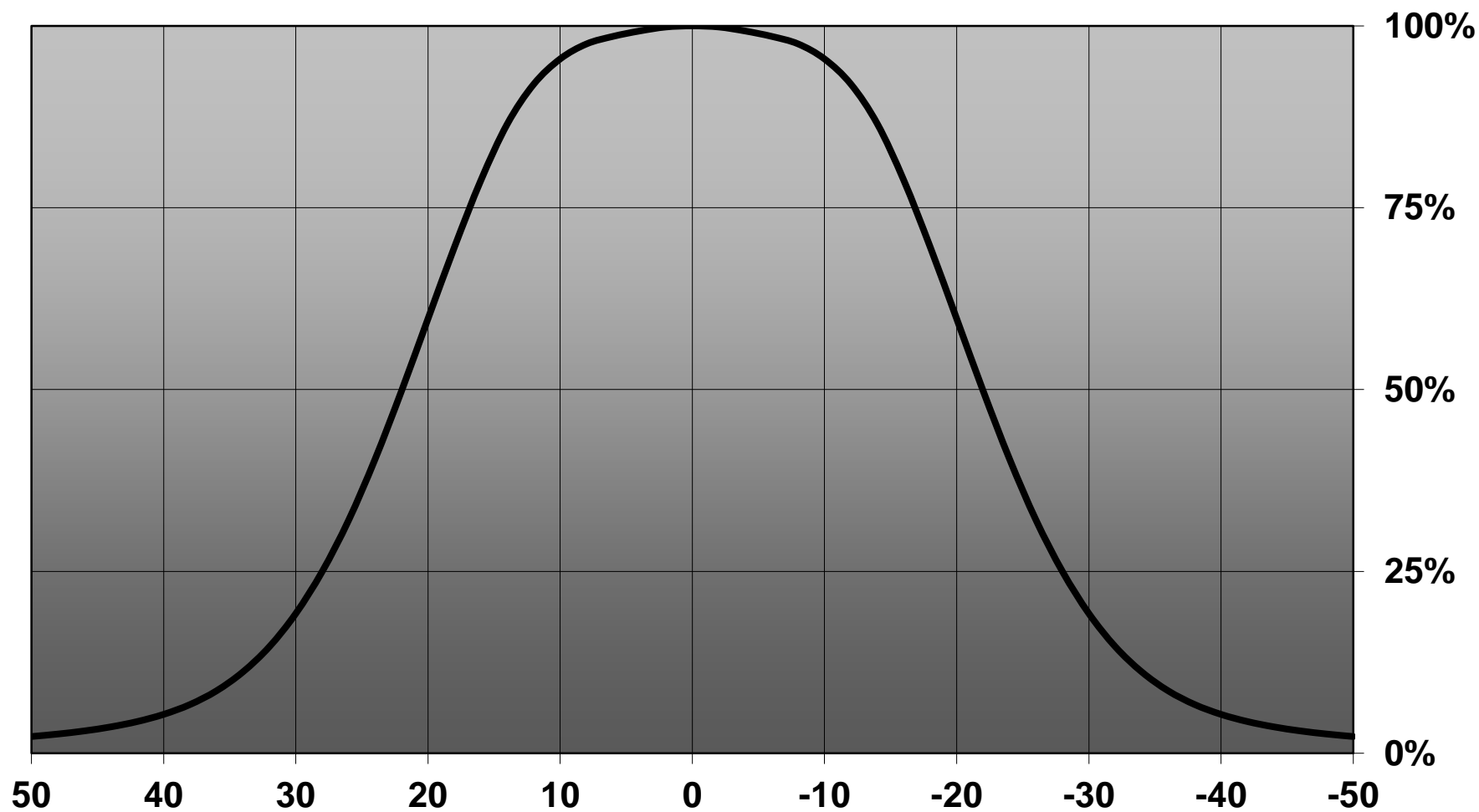

Relative intensity of FA11116\_LXP-O-90-HEW

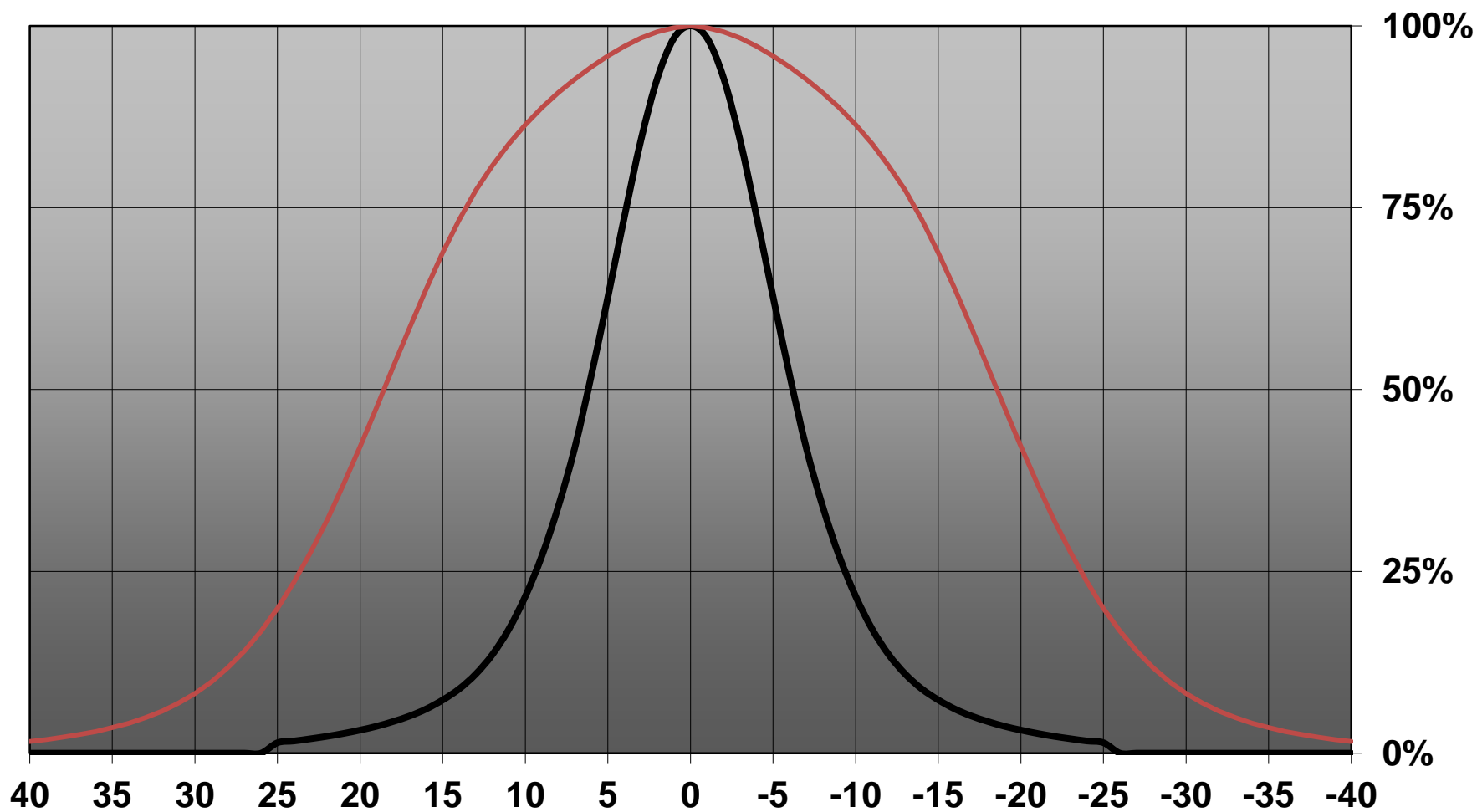

# Relative intensity of CA11631\_LXP3-G-RS

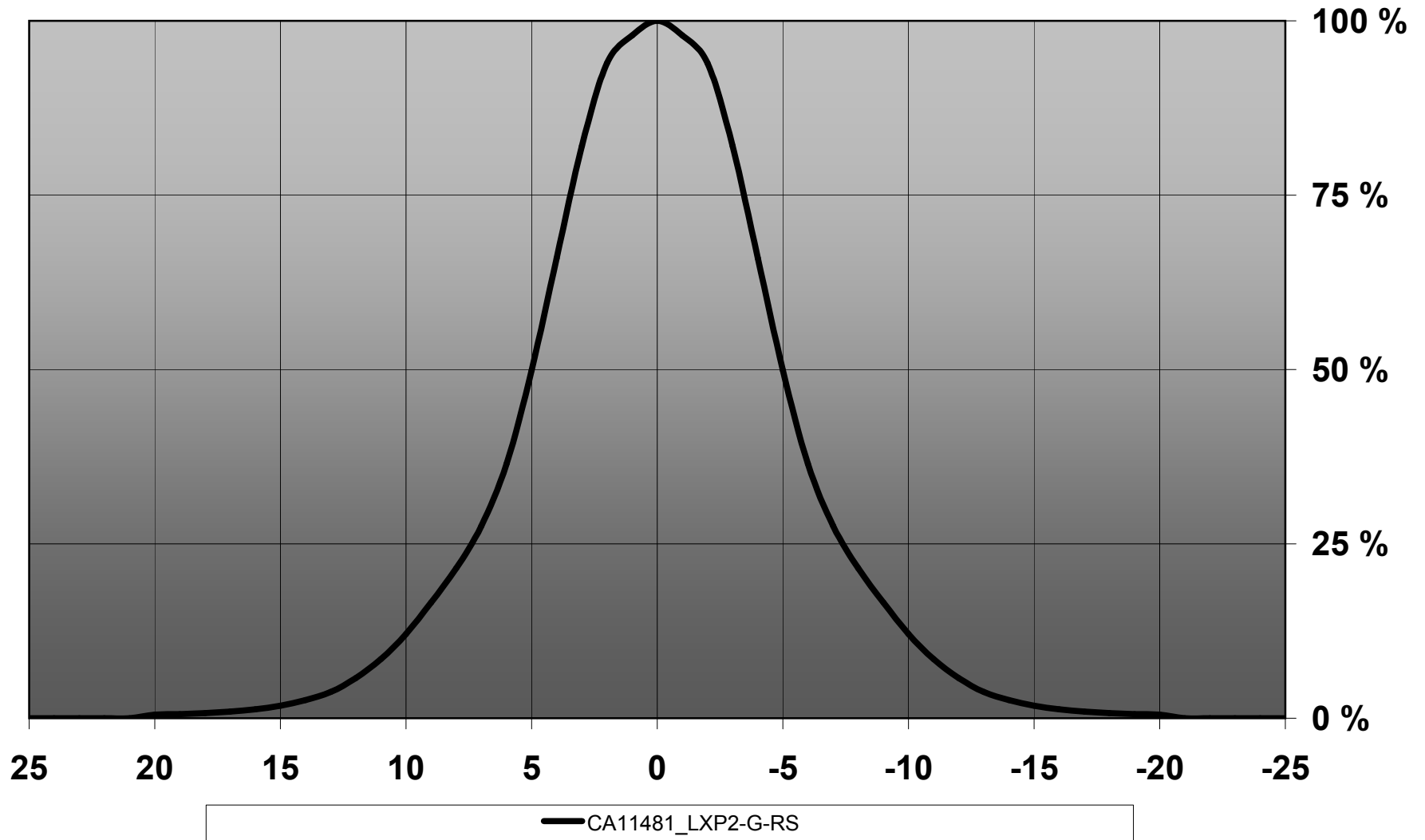

Relative intensity of CA11481\_LXP2-RS

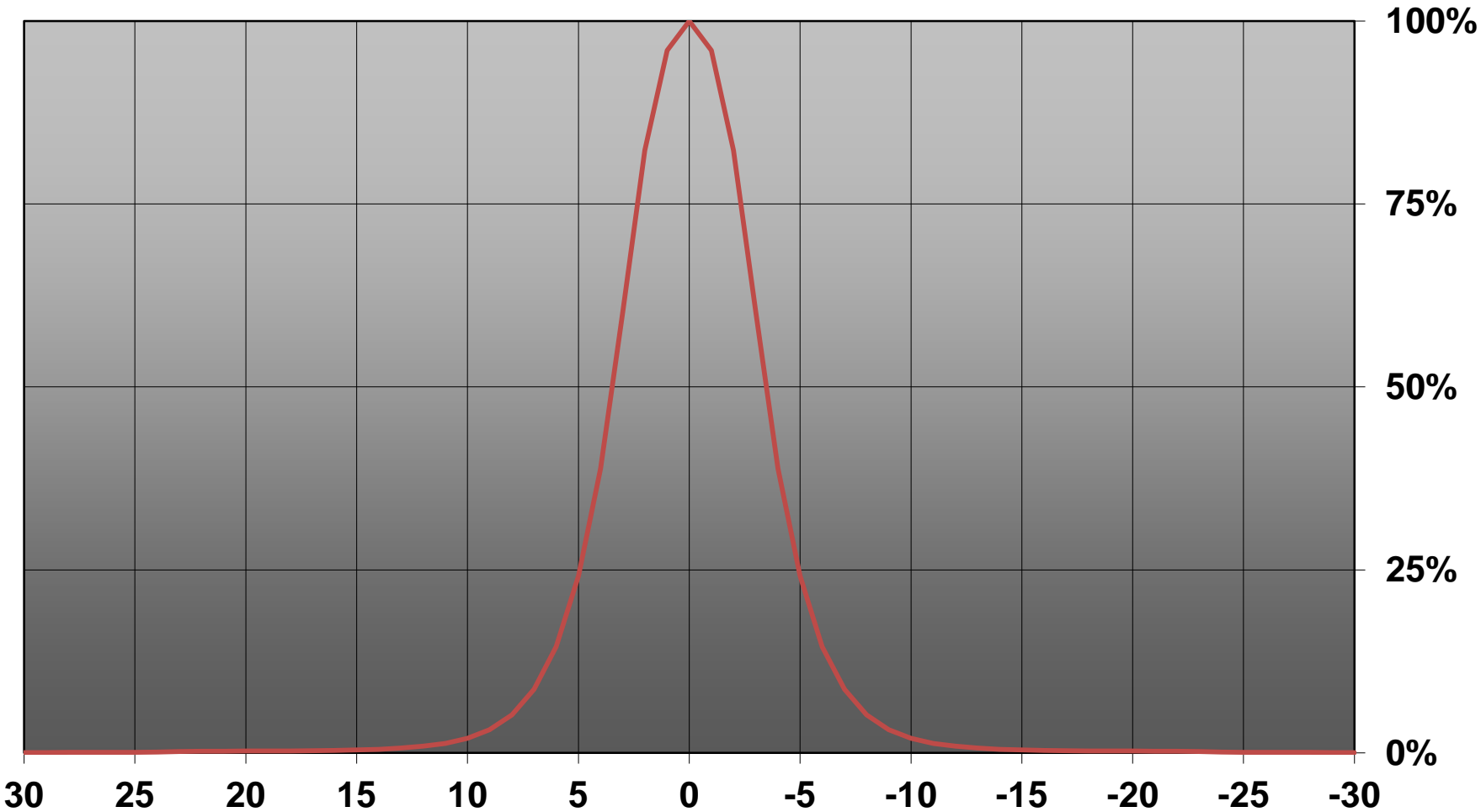



Relative intensity of CA11482\_LXP2-G-D

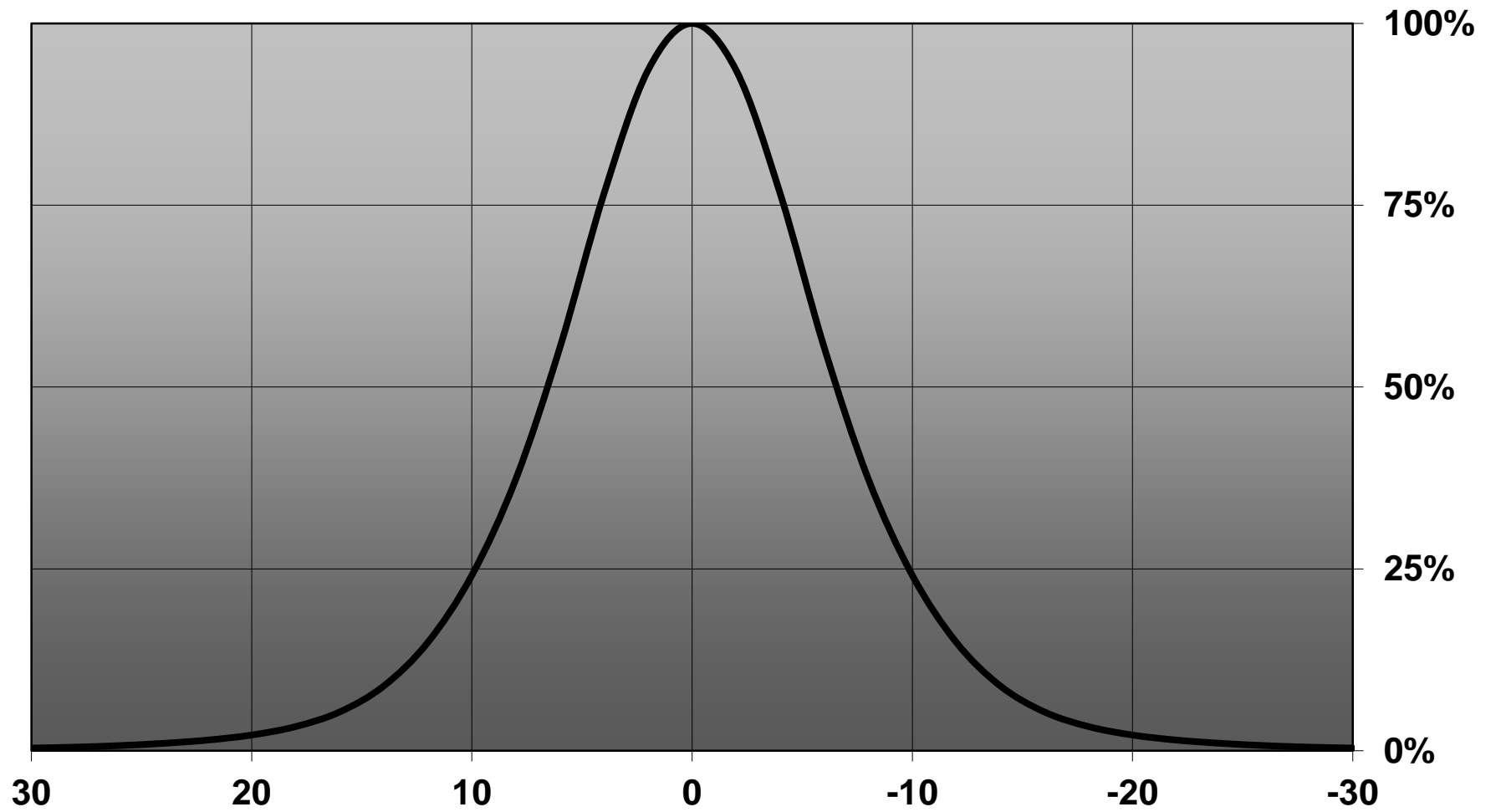

### Relative intensity of CA11482\_LXP2-D

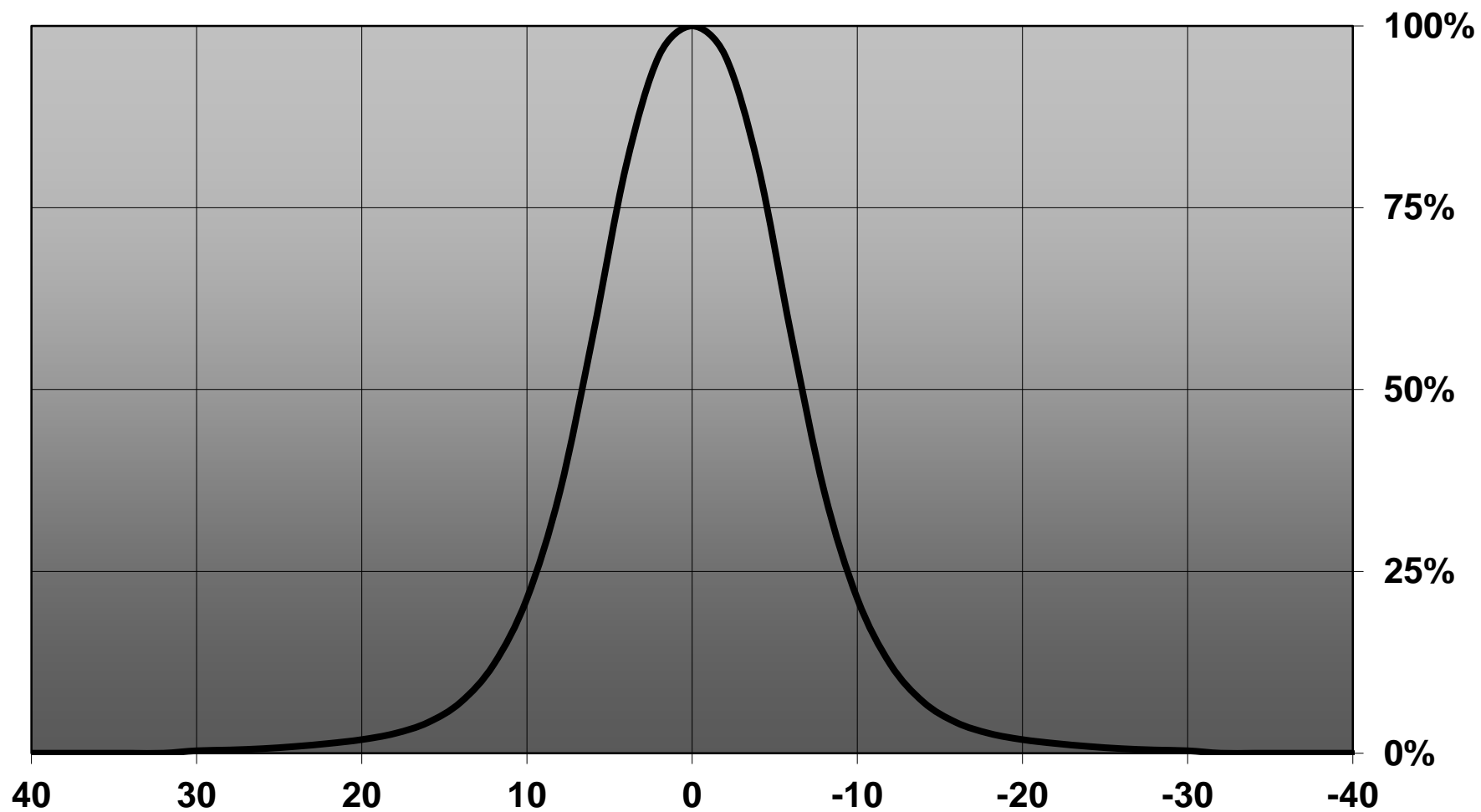

### Relative intensity of CA11483\_LXP2-G-M

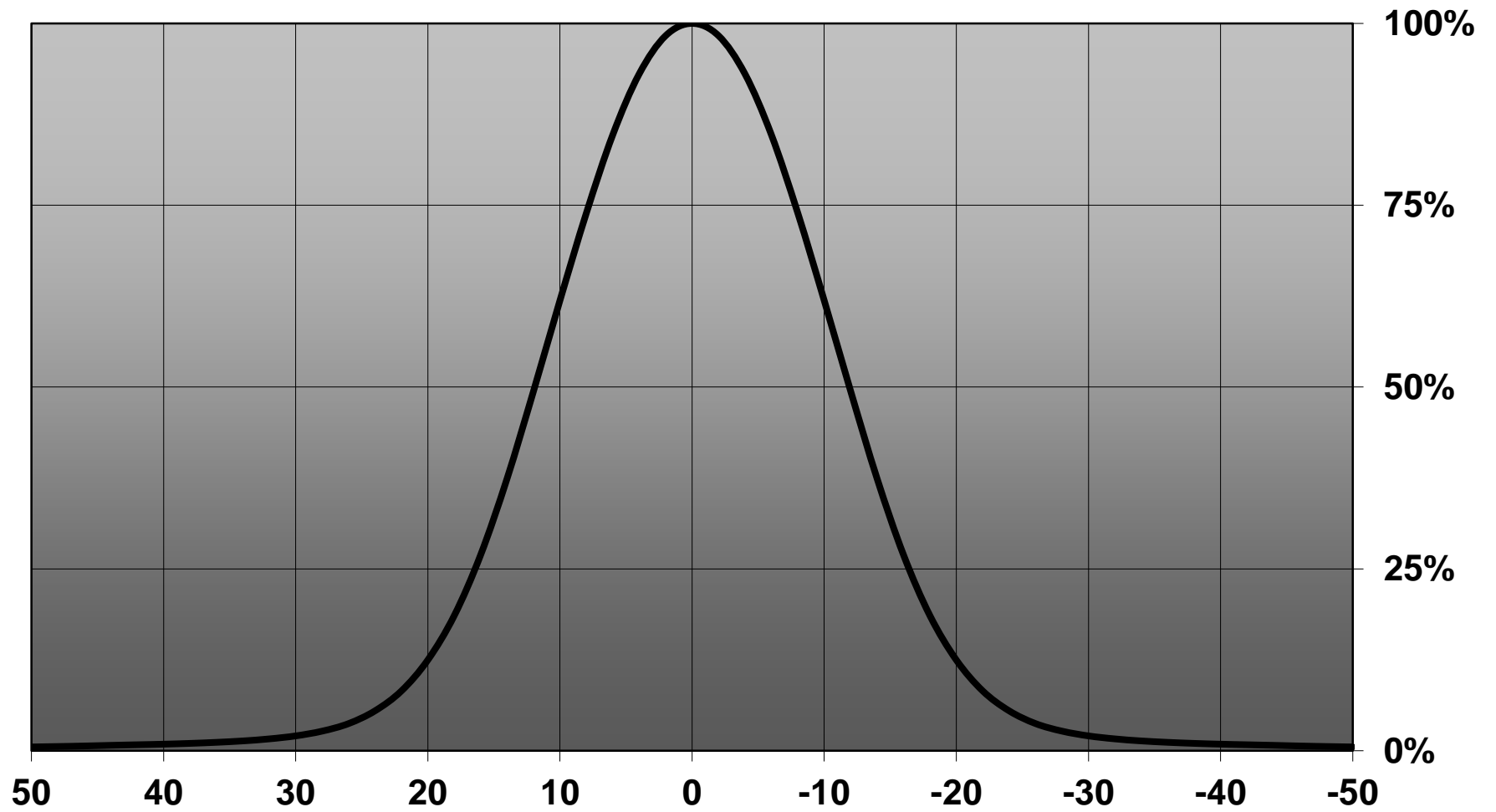

**Relative intensity of CA11483\_LXP2-M & Cree XP-E-HEW**

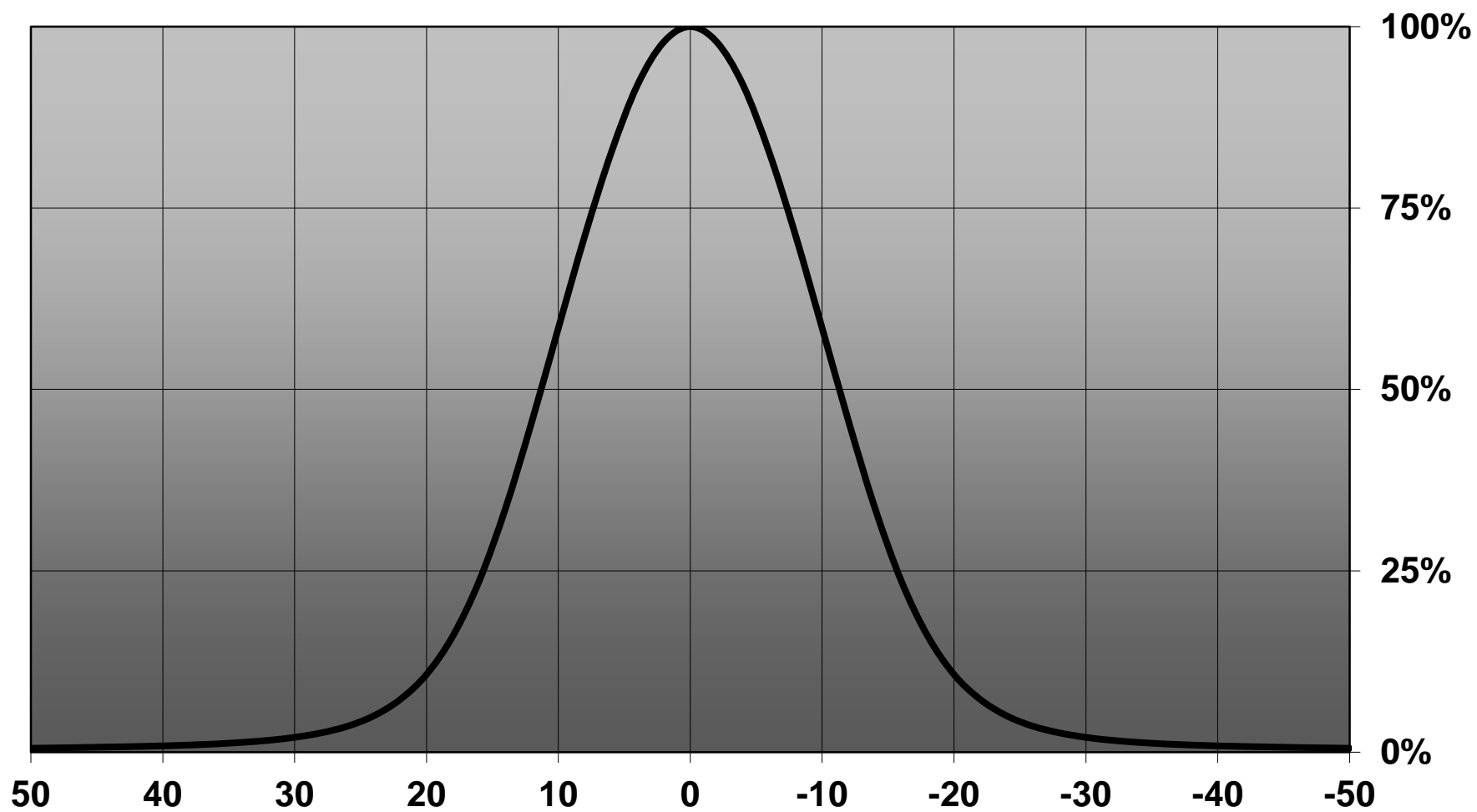

D

C

B

A

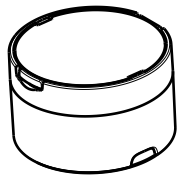

Isometric view  
Scale: 1:1

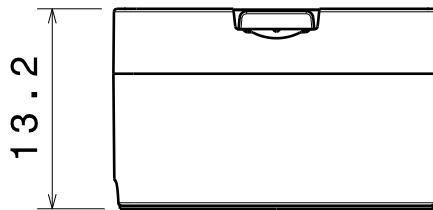
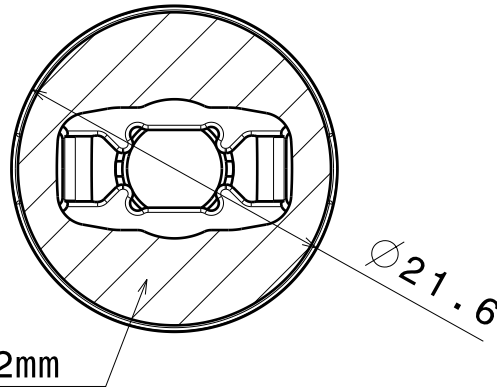

MATERIALS  
Lens: PMMA  
Holder: PC  
Tape: PU Foam

Part no.s:  
FA11109\_LOST-RS  
FA11110\_LOST-D  
FA11112\_LOST-M  
FA11114\_LOST-O-90  
FA11115\_LOST-REC

This drawing is our property.  
It can't be reproduced  
or communicated without  
our written agreement.



Ledil Oy  
Tehdaskatu 13  
FIN-24100 SALO  
Finland

DRAWING TITLE

Datasheet Lost-Series assy

DRAWN BY pv	DATE 09.03.2010
----------------	--------------------

CHECKED BY hh	DATE 17.09.2009
------------------	--------------------

DESIGNED BY pv	DATE 17.09.2009
-------------------	--------------------

SIZE A4	DRAWING NUMBER	REV 1
SCALE 2:1	WEIGHT (g) -	SHEET 1/1

D

A

4

4

3

3

2

2

1

1