

Position switches LS, proximity switches LS, pressure switches MCS

Moeller's safety/position switches are used everywhere where positions must be exactly registered. The LSE-Titan electronic safety/position switch allows the switching point to be set quickly and without complication. Proximity switches in various designs switch reliably and without contact.



Safety position switches LS-Titan

- Positions reliably registered
- Cage Clamp and screw terminals
- Metal or insulated
- Positively opening contacts
- Simple mounting of the various operating heads

Page 3/2

Electronic safety position switches LSE-Titan

- Switching point simply and variably adjustable
- Analogue 0-10 V DC or 4-20 mA
- Cage Clamp

Page 3/3



Safety door switches safety position switches

- Safety for personnel and processes
- Safety and interlocking of protective doors
- Safe switch off in emergencies
- Prevent tampering

Page 3/10

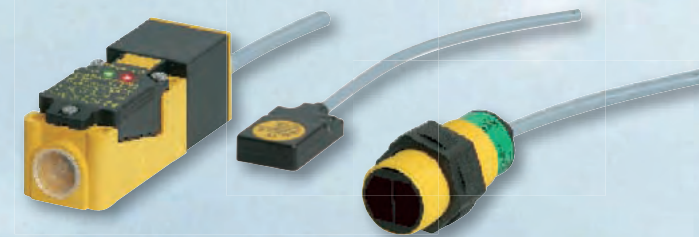

Proximity switches LSI, LSC, LSO

- Non-contact, safe switching: inductive, capacitive and optical
- Various types of construction

Page 3/15



Pressure switches MCSN/MCS

- For pressure monitoring of liquids and gases e.g. compressed air.
- Two adjustable switching points (ON an OFF switching points)
- 1 pole or 3 pole for actuation of control circuits or load switching

Page 3/18



Position switches



Safety switches



Proximity switches Pressure switches



	Page		Page		Page
System overview	3/2	System overview	3/10	Ordering	3/15
Ordering	3/3	Ordering	3/10	Inductive proximity switches	3/15
Complete units	3/3	Basic devices	3/12	Capacitive and optical proximity switches	3/16
Operating heads	3/8	Actuators, accessories	3/13	Accessories	3/17
Accessories	3/9	Door flap/hinge-operated switches, position switches	3/14	Pressure switches with main contacts	3/18
Engineering	3/21	Technical data	3/27	Pressure switches with auxiliary contacts	3/19
Contact travel diagrams	3/21	Dimensions	3/35	Accessories	3/20
Technical data	3/25			Engineering	3/24
Dimensions	3/33			Contact diagrams, changing the active area	3/24
				Technical data	3/28
				Inductive proximity switch	3/28
				Capacitive proximity switches	3/30
				Optical proximity switches	3/31
				Pressure switches	3/32
				Dimensions	3/39
				Inductive proximity switches	3/39
				Capacitive and optical proximity switches	3/40
				Pressure switches	3/41

Position switches LS, proximity switches LS, pressure switches MCS

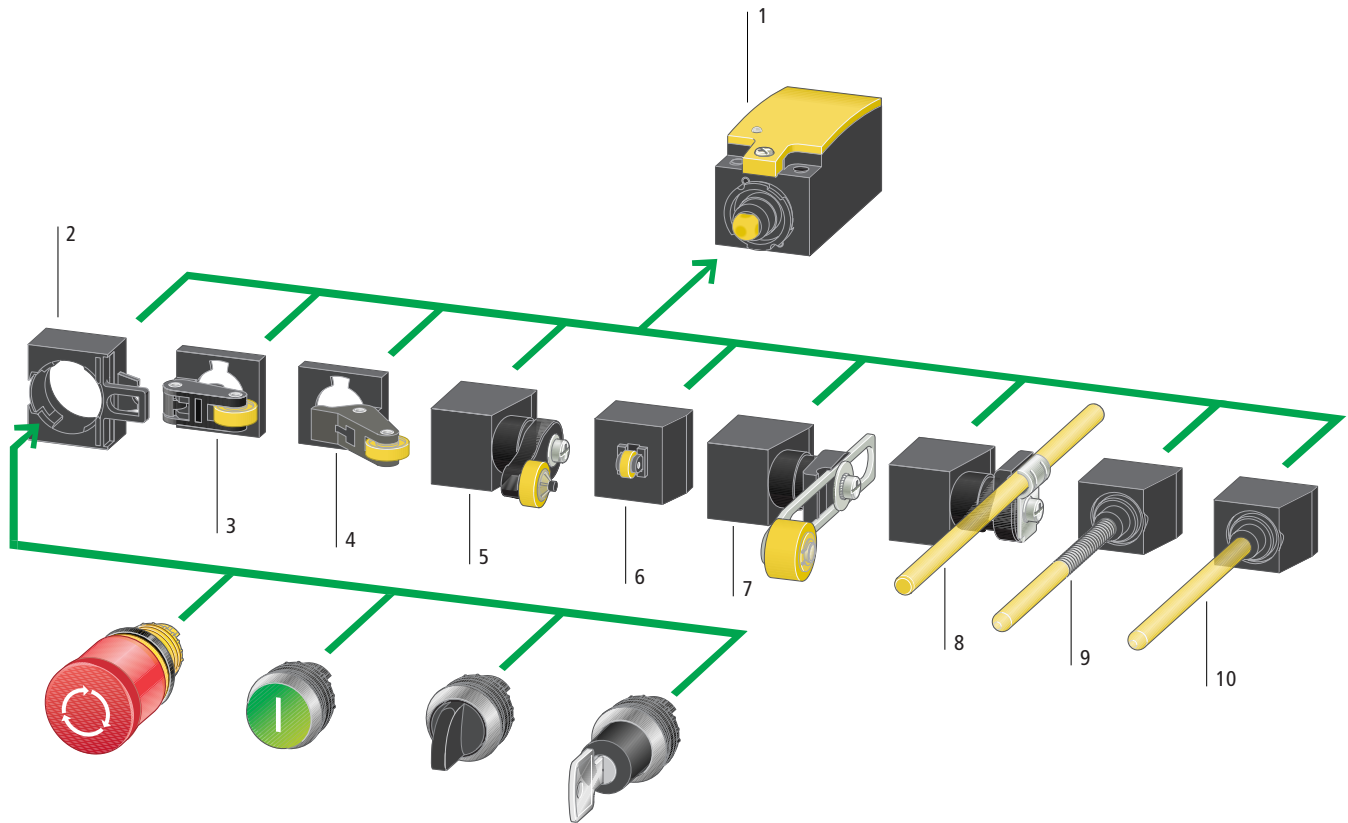

LS, LSM

Basic devices

Basic device	1
according to EN 50047	
With screw-on cover	
Contacts: 1NO/1NC, 2NO, 2NC	
Cage Clamp, screw terminal	
As snap-action or standard-action switch	
As electronic snap-action switch, (individually adjustable)	
As 4-20 mA analog signal encoder	
As 0-10 V DC analog signal encoder	
→ page 3/3	

Operating heads

Can be rotated by 90°

Fixing adapter	2
Actuation by front element RMQ-Titan	
Roller lever	3
For one-sided operation with higher operating speed	
Angled roller lever	4
For actuation along the unit axis	
Rotary lever	5
For actuation from the side, for pendulum movements	
→ page 3/6	

Operating heads

Can be rotated by 90°





Roller plunger	6
For actuation from the side with low actuating force	
Adjustable roller lever	7
For length adjustment as required	
Actuating rod	8
On conveyor belts for lightweight goods	
Spring-rod	9
For flexible actuation from all sides	
Actuating rod	10
Withdrawable mechanism from front	
→ page 3/6	

LS, LSM product features

- Modular system
- IP65 and IP66 degree of protection
-  (except LSM)
- Personnel protection
- Positive operation
- ⚡ Safety function by positive opening according to IEC/EN 60947-5-1 Up to category 4 according to EN 954-1
- Suitable for use with electronic devices to IEC/EN 61131-2
- Devices for world markets

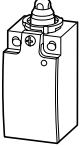
Notes

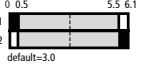
Do not use as a mechanical stop/shipping brace. Cage Clamp is a registered trademark of Wago Kontakttechnik, 32423 Minden, Germany.

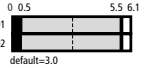
Contacts		Contact sequence	Contact travel	Colour of enclosure cover	Insulated material	Price	Std. pack
N/O = Normally open N/C = Normally closed ☉ = positive opening safety function to IEC/EN 60947-5-1			■ = contact closed □ = contact open ▨ = setting range		Part no. Article no.	see price list	
N/O = Normally open	N/C = Normally closed						
IP66, IP67 operating point electronically adjustable							
Basic unit Visible status display, comparable with positive opening function Conditional short-circuit, restart after reset							
							
	1 N/O	1 N/C			●	LSE-11 266121	1
		2 N/C			●	LSE-02 266122	1 off

Position switch



Notes LSE-11 and LSE-02: Individual operating point adjustment:

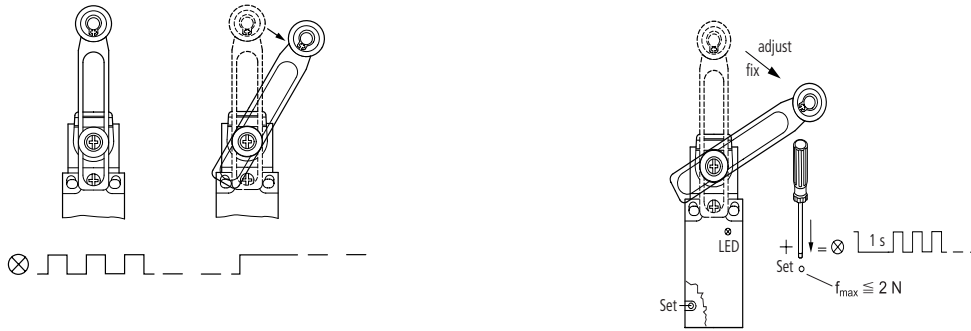

circuit example for series connection:
LSE-11 and LSE-02 can be used in safety circuits

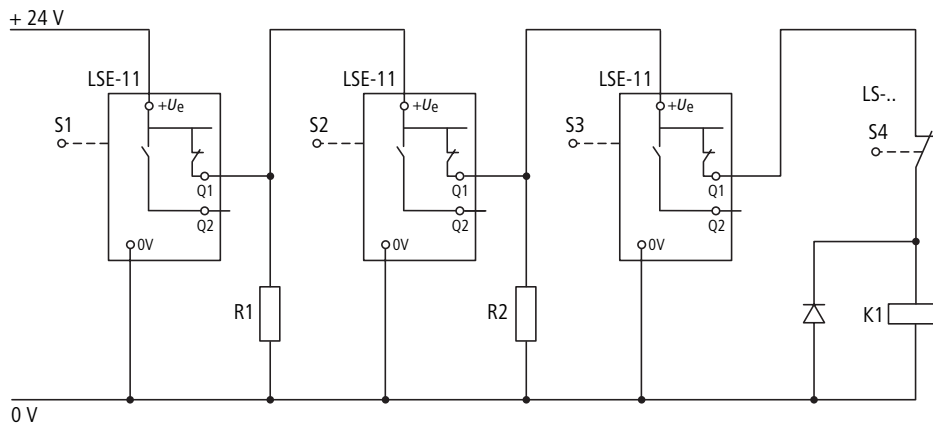

S1 is connected to 24 V DC
S2, S3 each switch with a delay of 0.7 s
R1, R2 e.g. series element M22-XLED60 (2820 Ω/0.5 W)

Analog electronic position switches IP66, IP67

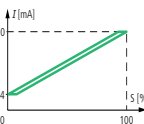
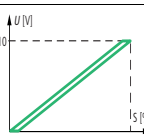
Basic unit Visual status indication Q1 = analog output Q2 = diagnostics output (the diagnostics output has a 0 V signal in the event of a fault.)	4 – 20 mA		●	LSE-AI 269461	1 off
	0 – 10 V		●	LSE-AU 274096	1 off

Auxiliary contacts: ⊕ = safety function, by positive opening to IEC/EN 60947-5-1

Contact sequence

Contact travel

■ = contact closed
□ = contact open

Colour of enclosure cover

Housing

Terminal connection

Part no. Article no.

Price see price list

Std. pack

N/O = Normally open
N/C = Normally closed

Rounded plunger, IP66, IP67

Basic unit

Front fixing, non expandable

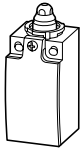

	2 N/C ⊕			●	Insulated material	Cage Clamp	LS-02/F 292365	1 off	
	2 N/C ⊕			●	Insulated material	Screw terminal	LS-S02/F 106780	1 off	
	2 N/C ⊕			●	Metal	Cage Clamp	LSM-02/F 292371	1 off	
	1 N/O	1 N/C ⊕			●	Insulated material	Cage Clamp	LS-11/F 290176	1 off
	1 N/O	1 N/C ⊕			●	Insulated material	Screw terminal	LS-S11/F 106784	1 off
	1 N/O	1 N/C ⊕			●	Metal	Cage Clamp	LSM-11/F 292372	1 off
	1 N/O	1 N/C ⊕			●	Insulated material	Cage Clamp	LS-11D/F 292366	1 off
	1 N/O	1 N/C ⊕			●	Insulated material	Screw terminal	LS-S11D/F 106792	1 off
	1 N/O	1 N/C ⊕			●	Metal	Cage Clamp	LSM-11D/F 292373	1 off
	1 N/O	1 N/C ⊕			●	Insulated material	Cage Clamp	LS-11DA/F 292369	1 off
	1 N/O	1 N/C ⊕			●	Insulated material	Screw terminal	LS-S11DA/F 106796	1 off
	1 N/O	1 N/C ⊕			●	Metal	Cage Clamp	LSM-11DA/F 292376	1 off
	1 N/O	1 N/C ⊕		Snap-action contact 	●	Insulated material	Cage Clamp	LS-11S/F 292367	1 off
	1 N/O	1 N/C ⊕			●	Insulated material	Screw terminal	LS-S11S/F 106799	1 off
	1 N/O	1 N/C ⊕			●	Metal	Cage Clamp	LSM-11S/F 292374	1 off
	2 N/O				●	Insulated material	Cage Clamp	LS-20/F 292368	1 off
	2 N/O				●	Insulated material	Screw terminal	LS-S20/F 106809	1 off
	2 N/O				●	Metal	Cage Clamp	LSM-20/F 292375	1 off
	2 N/O				●	Insulated material	Cage Clamp	LS-20A/F 292370	1 off
	2 N/O				●	Insulated material	Screw terminal	LS-S20A/F 106811	1 off
	2 N/O				●	Metal	Cage Clamp	LSM-20A/F 292377	1 off

Expandable with operating heads

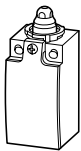

	2 N/C ⊕			●	Insulated material	Cage Clamp	LS-02 266107	10 off
	2 N/C ⊕			●	Insulated material	Cage Clamp	LS-02-SW 272009	10 off
	2 N/C ⊕			●	Insulated material	Screw terminal	LS-S02 106729	10 off
	2 N/C ⊕			●	Insulated material	Screw terminal	LS-S02-SW 106782	10 off
	2 N/C ⊕			●	Metal	Cage Clamp	LSM-02 266142	2 off

Notes Cage Clamp is a registered trademark of Wago Kontakttechnik, 32432 Minden, Germany.

Position switch



Auxiliary contacts: ⊕ = safety function, by positive opening to IEC/EN 60947-5-1

Contact sequence

Contact travel

■ = contact closed
□ = contact open

Colour of enclosure cover

Housing

Terminal connection

Part no. Article no.

Price see price list

Std. pack

N/O = Normally open
N/C = Normally closed

Rounded plunger, IP66, IP67

Basic unit

Expandable with operating heads

	Contact sequence	Contact travel	Colour of enclosure cover	Housing	Terminal connection	Part no. Article no.	Price see price list	Std. pack	
	1 N/O	1 N/C ⊕			●	Insulated material EN 50047 Form B	Cage Clamp	LS-11 266109	10 off
	1 N/O	1 N/C ⊕		●	Cage Clamp	LS-11-SW 272006	10 off		
	1 N/O	1 N/C ⊕		●	Screw terminal	LS-S11 106783	10 off		
	1 N/O	1 N/C ⊕		●	Screw terminal	LS-S11-SW 106807	10 off		
	1 N/O	1 N/C ⊕		●	Metal EN 50047 Form B	LSM-11 266144	2 off		
	1 N/O	1 N/C ⊕			●	Insulated material	Cage Clamp	LS-11D 266114	10 off
	1 N/O	1 N/C ⊕		●	Cage Clamp	LS-11D-SW 272007	10 off		
	1 N/O	1 N/C ⊕		●	Screw terminal	LS-S11D 106791	10 off		
	1 N/O	1 N/C ⊕		●	Screw terminal	LS-S11D-SW 106797	10 off		
	1 N/O	1 N/C ⊕		●	Metal	Cage Clamp	LSM-11D 266149	2 off	
	1 N/O	1 N/C ⊕			●	Insulated material	Cage Clamp	LS-11DA 292361	1 off
	1 N/O	1 N/C ⊕		●	Screw terminal	LS-S11DA 106795	1 off		
1 N/O	1 N/C ⊕		●	Metal	Cage Clamp	LSM-11DA 292363	1 off		
1 N/O	1 N/C ⊕		Snap-action contact 	●	Insulated material EN 50047 Form B	Cage Clamp	LS-11S 266105	10 off	
1 N/O	1 N/C ⊕		●	Cage Clamp	LS-11S-SW 272020	10 off			
1 N/O	1 N/C ⊕		●	Screw terminal	LS-S11S 106798	10 off			
1 N/O	1 N/C ⊕		●	Screw terminal	LS-S11S-SW 106806	10 off			
1 N/O	1 N/C ⊕		●	Metal EN 50047 Form B	Cage Clamp	LSM-11S 266140	2 off		
2 N/O				●	Insulated material	Cage Clamp	LS-20 266120	10 off	
2 N/O			●	Cage Clamp	LS-20-SW 272008	10 off			
2 N/O			●	Screw terminal	LS-S20 106808	10 off			
2 N/O			●	Screw terminal	LS-S20-SW 106812	10 off			
2 N/O			●	Metal	Cage Clamp	LSM-20 266155	2 off		
2 N/O				●	Insulated material	Cage Clamp	LS-20A 292362	1 off	
2 N/O			●	Screw terminal	LS-S20A 106810	1 off			
2 N/O			●	Metal	Cage Clamp	LSM-20A 100051	2 off		

Notes Cage Clamp is a registered trademark of Wago Kontakttechnik, 32432 Minden, Germany.

Position switch



Position switch

Auxiliary contacts: ⊕ = safety function, by positive opening to IEC/EN 60947-5-1

Contact sequence

Contact travel

■ = contact closed
□ = contact open

Colour of enclosure cover

Housing

Terminal connection

Part no. Article no.

Price see price list

Std. pack

N/O = Normally open
N/C = Normally closed

Spring-rod actuator IP66, IP67

Do not use spring-rod actuator as a safety position switch; admissible only with snap-action contact.



1 N/O	1 N/C ⊕
1 N/O	1 N/C ⊕
1 N/O	1 N/C ⊕

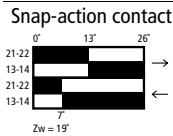

●	Insulated material	Cage Clamp
●	Insulated material	Screw terminal
●	Metal	Cage Clamp

LS-11S/S	266104
LS-S11S/S	106805
LSM-11S/S	266139

2 off
2 off
2 off

Roller plungers, IP66, IP67

EN 50047 Form C

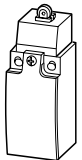

1 N/O	1 N/C ⊕
1 N/O	1 N/C ⊕
1 N/O	1 N/C ⊕

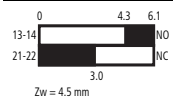

●	Insulated material	Cage Clamp
●	Insulated material EN 50047 Form C	Screw terminal
●	Metal EN 50047 Form C	Cage Clamp

LS-11/P	266112
LS-S11/P	106788
LSM-11/P	266147

2 off
2 off
2 off

1 N/O	1 N/C ⊕
1 N/O	1 N/C ⊕
1 N/O	1 N/C ⊕



●	Insulated material EN 50047 Form C	Cage Clamp
●	Insulated material EN 50047 Form C	Screw terminal
●	Metal EN 50047 Form C	Cage Clamp

LS-11S/P	266118
LS-S11S/P	106801
LSM-11S/P	266153

2 off
2 off
2 off

Adjustable roller levers, IP66, IP67

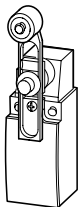

1 N/O	1 N/C ⊕
1 N/O	1 N/C ⊕
1 N/O	1 N/C ⊕

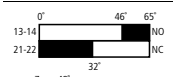

●	Insulated material	Cage Clamp
●	Insulated material	Screw terminal
●	Metal	Cage Clamp

LS-11/RLA	266113
LS-S11/RLA	106790
LSM-11/RLA	266148

2 off
2 off
2 off

1 N/O	1 N/C ⊕
1 N/O	1 N/C ⊕
1 N/O	1 N/C ⊕



●	Insulated material	Cage Clamp
●	Insulated material	Screw terminal
●	Metal	Cage Clamp

LS-11S/RLA	266119
LS-S11S/RLA	106803
LSM-11S/RLA	266154

2 off
2 off
2 off

IP66, IP67 actuating rod

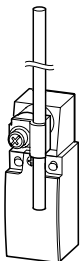

1 N/O	1 N/C ⊕
1 N/O	1 N/C ⊕
1 N/O	1 N/C ⊕

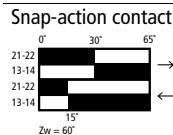









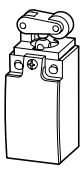

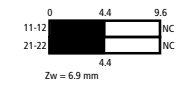

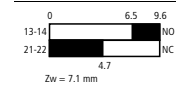

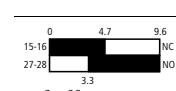

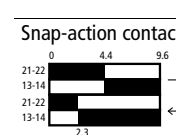

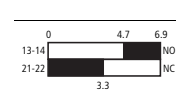
●	Insulated material	Cage Clamp
●	Insulated material	Screw terminal
●	Metal	Cage Clamp

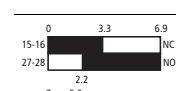
LS-11S/RR	266106
LS-S11S/RR	106804
LSM-11S/RR	266141

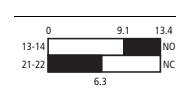
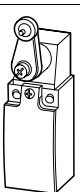
4 off
4 off
4 off

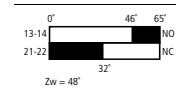
Notes Cage Clamp is a registered trademark of Wago Kontakttechnik, 32432 Minden, Germany.







Auxiliary contacts: ☉ = safety function, by positive opening to IEC/EN 60947-5-1		Contact sequence	Contact travel	Colour of enclosure cover	Housing	Terminal connection	Part no. Article no.	Price see price list	Std. pack	
N/O = Normally open	N/C = Normally closed		■ = contact closed □ = contact open							
Roller lever IP66, IP67										
Long										
	2 N/C ☉			●	Insulated material	Cage Clamp	LS-02/L 266108		2 off	
	2 N/C ☉			●	Insulated material	Screw terminal	LS-S02/L 106781		2 off	
	2 N/C ☉			●	Metal	Cage Clamp	LSM-02/L 266143		2 off	
	1 N/O	1 N/C ☉			●	Insulated material	Cage Clamp	LS-11/L 266110		2 off
	1 N/O	1 N/C ☉			●	EN 50047 Form E	Screw terminal	LS-S11/L 106785		2 off
	1 N/O	1 N/C ☉			●	Metal	Cage Clamp	LSM-11/L 266145		2 off
	1 N/O	1 N/C ☉			●	Insulated material	Cage Clamp	LS-11D/L 266115		2 off
	1 N/O	1 N/C ☉			●	Insulated material	Screw terminal	LS-S11D/L 106793		2 off
	1 N/O	1 N/C ☉			●	Metal	Cage Clamp	LSM-11D/L 266150		2 off
	1 N/O	1 N/C ☉		Snap-action contact 	●	Insulated material	Cage Clamp	LS-11S/L 266116		2 off
	1 N/O	1 N/C ☉			●	EN 50047 Form E	Screw terminal	LS-S11S/L 106800		2 off
	1 N/O	1 N/C ☉			●	Metal	Cage Clamp	LSM-11S/L 266151		2 off
Short										
1 N/O	1 N/C ☉			●	Insulated material	Cage Clamp	LS-11/LS 290173		1 off	
1 N/O	1 N/C ☉			●	Insulated material	Screw terminal	LS-S11/LS 106787		1 off	
1 N/O	1 N/C ☉			●	Insulated material	Cage Clamp	LS-11D/LS 290174		1 off	
1 N/O	1 N/C ☉			●	Insulated material	Screw terminal	LS-S11D/LS 106794		1 off	
Roller lever, large										
1 N/O	1 N/C ☉			●	Insulated material	Cage Clamp	LS-11/LB 290175		1 off	
1 N/O	1 N/C ☉			●	Insulated material	Screw terminal	LS-S11/LB 106786		1 off	
Rotary lever, IP66, IP67										
	1 N/O	1 N/C ☉			●	Insulated material	Cage Clamp	LS-11/RL 266111	2 off	
	1 N/O	1 N/C ☉			●	Insulated material	Screw terminal	LS-S11/RL 106789	2 off	
	1 N/O	1 N/C ☉			●	Metal	Cage Clamp	LSM-11/RL 266146	2 off	
	1 N/O	1 N/C ☉		Snap-action contact 	●	Insulated material	Cage Clamp	LS-11S/RL 266117	2 off	
	1 N/O	1 N/C ☉			●	Insulated material	Screw terminal	LS-S11S/RL 106802	2 off	
	1 N/O	1 N/C ☉			●	Metal	Cage Clamp	LSM-11S/RL 266152	2 off	
Customer specific complete device IP66, IP67										
(*) user-definable customer ID or warehouse No.; up to 10 characters										
					Insulated material		LS-COMBINATION-* 266168		1 off	







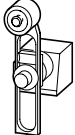
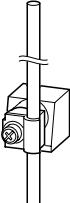
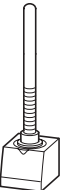
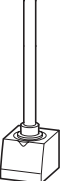

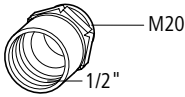
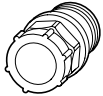

Position switch

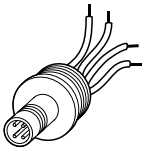

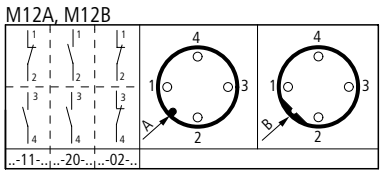
Notes Cage Clamp is a registered trademark of Wago Kontakttechnik, 32432 Minden, Germany.

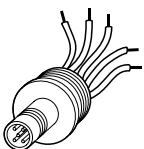

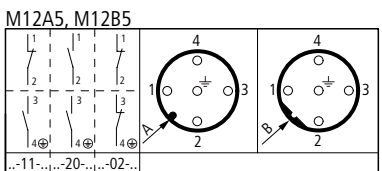
		Insulated material Part no. Article no.	Metal Part no. Article no.	Std. pack	Notes	
Operating heads						
Roller plungers						
		LS-XP 266125	LSM-XP 266158	10 off	The operating heads can be rotated in 90° stages to match the specified direction of operation.	
Roller lever						
	Long	LS-XL 266123	LSM-XL 266156	10 off		
	Short	LS-XLS 290177				
	Large	LS-XLB 290178		1 off		
Angled roller lever						
		LS-XLA 266124	LSM-XLA 266157	10 off		
Rotary lever						
		LS-XRL 266126	LSM-XRL 266159	5 off		
Adjustable roller levers						
	D = 18 mm	LS-XRLA 266127	LSM-XRLA 266160	4 off		
	D = 30 mm	LS-XRLA30 266128				
	D = 40 mm	LS-XRLA40 266129				
	D = 40 mm (rubber)	LS-XRLA40R 266130				
Actuating rods						
	Plastic rod	LS-XRR 266131	LSM-XRR 266161	4 off		
	Metal rod	LS-XRRM 266132	LSM-XRRM 266162	4 off		
Spring-rod						
	Not to be used as a safety position switch Use only in conjunction with snap-action contact.	LS-XS 266133	LSM-XS 266163	5 off		
Actuating rod						
		LS-XOR 290190		1 off		
Fixing adapter Actuation through RMQ-Titan® front elements						
		M22-LS 266137		10 off		

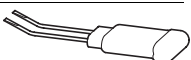
	For use with	Description	Part no. Article no.	Price see price list	Std. pack	Notes
		for use with american pipe thread, metal	V1/2"/M20-NA 225269		10 off	The screw connection must be earthed, not total insulation
		for use with american pipe thread, moulded material	V1/2"/M20 225270		10 off	
M20 diaphragm bolt, IP65						
With integral push-through membrane External diameter of cable up to 13 mm IP65 with cable inserted						
			EMS20 225271		25 off	
M20 screw closure						
(self-sealing grommet) For tightening / loosening by using a standard wrench for sealing grommet plugs						
			LS-X20 266134		25 off	
Plug connector, M12 × 1, IP65						
Moulded $U_i = 250 \text{ V}$, $I_{th} = 4 \text{ A}$ Fuse: 6 A gG/gL						
4-pole $U_e = 250 \text{ V}$						
	LS	„A” coded  Standard in IEC/EN 60947-5-2	M12A 266135		10 off	
	LS	„B” coded 	M12B 266136		10 off	
5-pole $U_e = 125 \text{ V}$						
	LSM	„A” coded  Standard in IEC/EN 60947-5-2	M12A5 272202		10 off	
	LSM	„B” coded 	M12B5 272203		10 off	
Cage Clamp twin N/C contact						
			LS-XTW 290179		1 off	

Position switch



LS-...ZBZ

Safety switches

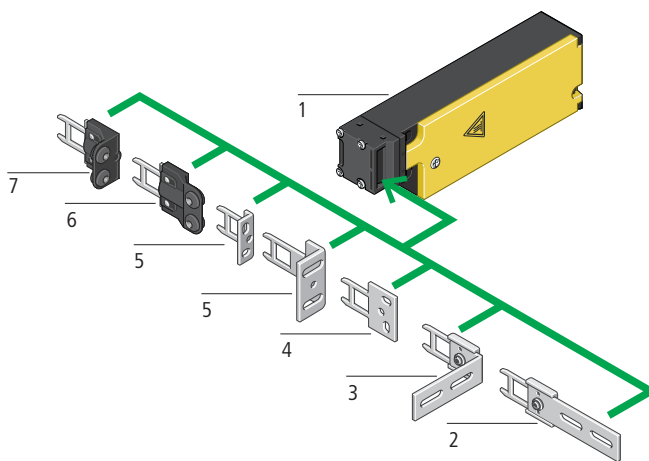

LS-...ZB

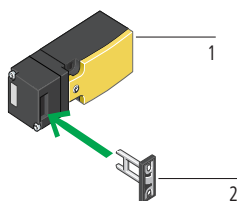

LSR-...TKG

LSR-...TS

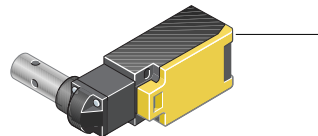
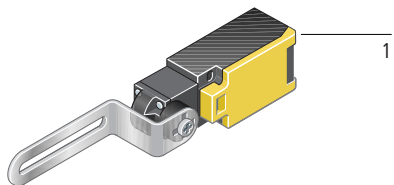

LS4-...ZB

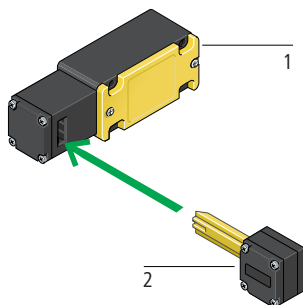

LS-...ZBZ

Basic device	1
Spring or magnet-powered interlock	
For increased personnel and process protection	
Tamper-proof	
Multiple coded actuators	
Contacts: 1 NO/1 NC or 2 NC	
→ page 3/12	

Flat flexible actuator	2
For doors that do not close precisely	
→ page 3/13	

Angled flexible actuator	3
For doors that do not close precisely	
→ page 3/13	

Flat actuator	4
For sliding doors	
→ page 3/13	

Angled actuator	5
For swing doors	
→ page 3/13	

Flat compensating actuator	6
For increased tolerance compensation in the direction of door closure	
→ page 3/13	

Angled compensating actuator	7
For increased tolerance compensation in the direction of door closure	
→ page 3/13	

LS-...ZB

Complete device	1
For personnel protection	
Contacts: 1 NC, 1 NO/1 NO or 2 NC	
5 directions of operation possible	
→ page 3/14	

Actuator	2
Multiple coding protection against tampering	

LSR-...TKG, LSR-...TS

Complete device	1
For personnel protection	
Contacts: 1 NO/1 NC or 2 NC	
For swing doors with fixed connection to the door/hinge pin	
LSR-...TKG → page 3/14	
LSR-...TS → page 3/14	

LS4-.../ZB

Complete device	1
Narrow enclosure version	
For personnel protection	
Contacts: 1NO, 1NO/1NC	
→ page 3/14	

Actuator	2
Multiple coding	
For horizontal or vertical operation	

Product features

- Interlocking device to EN 1088
- For use in safety circuits
- ⊕ Safety function by positive opening according to IEC/EN 60947-5-1

- Degree of protection IP65
- Operating head can be rotated 4 × 90°
- With M20 × 1.5 thread



Notes

Do not use as a mechanical stop/shipping brace.



Attention!
Any change to an original Moeller safety position switch is not permitted and automatically leads to the loss of all approvals





Auxiliary contacts: ⊕ = safety function, by positive opening to IEC/EN 60947-5-1

N/O = Normally open

N/C = Normally closed

Contact sequence

Rated control voltage for magnetic drive

U_s

V





Part no. Article no.

Price see price list

Std. pack

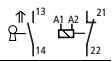
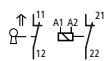

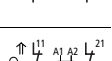

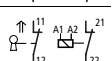

Basic units with spring-powered interlock (closed-circuit principle), IP65¹⁾

- With interlock monitoring and auxiliary release mechanism
- Monitoring of door position: continuous

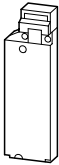
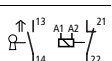
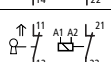
	1 N/O	1 N/C ⊕		24 V DC	LS-S11-24DFT-ZBZ/X 106829	1 off
		2 N/C ⊕		24 V DC		
	1 N/O	1 N/C ⊕		120 V 50/60 Hz	LS-S11-120AFT-ZBZ/X 106825	
		2 N/C ⊕		120 V 50/60 Hz		
	1 N/O	1 N/C ⊕		230 V 50/60 Hz	LS-S11-230AFT-ZBZ/X 106827	
		2 N/C ⊕		230 V 50/60 Hz		

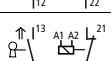
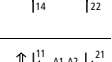
Basic units with magnet-powered interlock (open-circuit principle), IP65²⁾

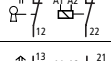
- With interlock monitoring
- Monitoring of door position: continuous

	1 N/O	1 N/C ⊕		24 V DC	LS-S11-24DMT-ZBZ/X 106830	1 off
		2 N/C ⊕		24 V DC		
	1 N/O	1 N/C ⊕		120 V 50/60 Hz	LS-S11-120AMT-ZBZ/X 106826	
		2 N/C ⊕		120 V 50/60 Hz		
	1 N/O	1 N/C ⊕		230 V 50/60 Hz	LS-S11-230AMT-ZBZ/X 106828	
		2 N/C ⊕		230 V 50/60 Hz		

- Notes**
- ¹⁾ Time control of the release operation possible using ESR4-NT30-30
 - ²⁾ Time control of the release operation possible using ESR4-NV30-30

Electric circuitry with DIL contactors and ESR4 safety relays Safety manual TB0-009, order no. 082309

With the actuator inserted, the NO contact is open and the NC contact is closed.



Switch must never be used as a mechanical stop!

The operating head can be rotated manually in 90° steps to suit the specified level of actuation.

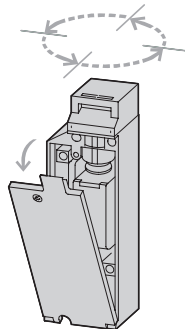

In the event of a loss of voltage, (e.g. during commissioning), the spring-powered LS-...-...FT-ZBZ can be released with a screwdriver. The auxiliary release mechanism must be sealed!

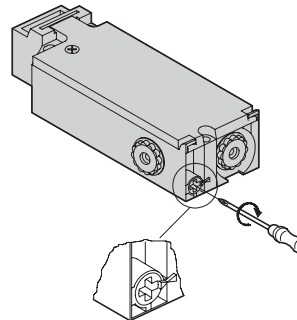

Care should be taken during mounting and operation that no foreign bodies enter the actuator's entry aperture.

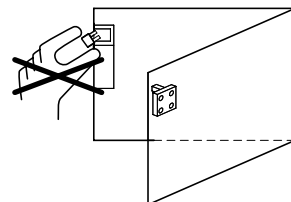





For degree of protection IP65, use V-M20 cable glands with connecting thread of max. 9 mm length

Accessories

V-M20 cable gland

Page

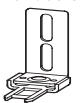
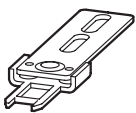
→ 13/35

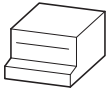
	Part no. Article no.	Price see price list	Std. pack
Actuators			
Stainless steel For combination with LS-...ZBZ/X basic devices			
Flat actuator For sliding doors 			
	LS-XG-ZBZ 106833		1 off
Angled actuator For swing doors from 250 mm width 			
short	LS-XW-ZBZ 106839		1 off
long	LS-XWA-ZBZ 106838		1 off
Angled, flexible actuator For doors that do not close precisely 			
	LS-XF-ZBZ 106832		1 off
even, flexible coasting actuator For doors that do not close precisely 			
	LS-XFG-ZBZ 106831		1 off
Flat, compensating actuator with increased tolerance in closing direction for inaccurately closing doors 			
	LS-XNG-ZBZ 106834		1 off
Angled, compensating actuator with increased tolerance in closing direction for inaccurately closing doors 			
	LS-XNW-ZBZ 106835		1 off
Accessories			
-			
Dust protection cap Prevents ingress of foreign matter into the device head 			
	LS-XSK-ZBZ 106837		1 off



Auxiliary contacts: ⊕ = safety function, by positive opening to IEC/EN 60947-5-1		Contact sequence	Contact sequence ■ = Contact closed □ = Contact open Zw = Positive opening sequence	Approval	Connection type	Part no. Article no.	Price see price list	Std. pack		
N/O = Normally open N/C = Normally closed										
Safety door flap switch LSR-.../TKG, IP65										
	2 N/C ⊕				Screw terminal	LSR-S02-1-I/TKG 106848		1 off		
	1 N/O	1 N/C ⊕							Screw terminal	LSR-S11-1-I/TKG 106847
Hinge-operated safety switch LSR-.../TS, IP65										
	2 N/C ⊕				Screw terminal	LSR-S02-1-I/TS 106852		1 off		
	1 N/O	1 N/C ⊕							Screw terminal	LSR-S11-1-I/TS 106851
Safety position switches LS...-ZB, IP65										
With the actuator inserted, the NO contact is open and the NC contact is closed.										
	2 N/C ⊕		—		Cage Clamp	LS-02-ZB 106817		2 off		
	2 N/C ⊕		—		Screw terminal	LS-S02-ZB 106874			1 off	
	1 N/O	1 N/C ⊕			—	Cage Clamp			LS-11-ZB 106819	2 off
	1 N/O	1 N/C ⊕			—	Screw terminal			LS-S11-ZB 106876	1 off
	1 N/O	1 N/C ⊕	—		Snap-action contact	Cage Clamp			LS-11S-ZB 106870	2 off
	1 N/O	1 N/C ⊕	—		Snap-action contact	Screw terminal			LS-S11S-ZB 106877	1 off
safety/ position switch LS4.../ZB, IP65										
With the actuator inserted, the NO contact is open and the NC contact is closed.										
	1 N/C ⊕		—		Screw terminal	LS4/S01-1-I/ZB 106855		1 off		
	1 N/O	1 N/C ⊕			—	Screw terminal			LS4/S11-1-I/ZB 106857	1 off

Notes Cage Clamp is a registered trademark of Wago Kontakttechnik, 32432 Minden, Germany.

Electric circuitry with DIL contactors and ESR4 safety relays a Safety manual TB0-009, order no. 082309

Actuator can be repositioned for horizontal or vertical installation. The operating heads can be rotated manually in 90° steps to suit the specified direction of operation.

Electric circuitry with DIL contactors and ESR4 safety relays Safety manual TB0-009, order no. 082309

Note: Care should be taken during mounting and operation that no foreign bodies enter the actuator's entry aperture.

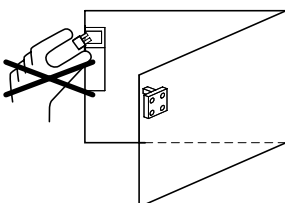

With the actuator inserted, the NO contact is open and the NC contact is closed.

For degree of protection IP65, use V-M20 cable glands with max 9 mm long thread.

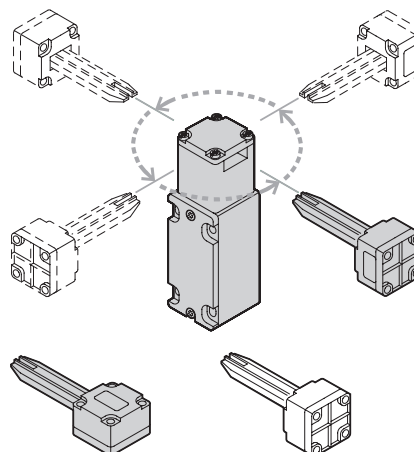

Accessories Page
V-M20 cable gland → 13/35

Contact sequences → Electronic Catalogue

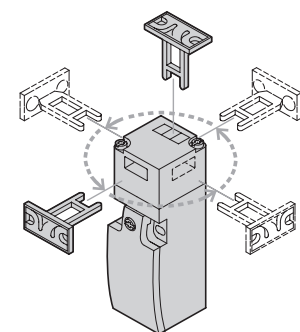

With the actuator inserted, the NO contact is open and the NC contact is closed.

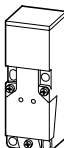

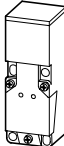
Contacts	Rated switching distance	Rated operating voltage	Style	Housing	Terminal connection	Fitting in metal	Part no. Article no.	Price see price list	Std. pack
N/O = normally open contact, C/O = changeover contact, P = programmable as N/C or N/O	S_n mm	U_e V DC	mm						
DC version, pulse-switching (PNP)									
	S	1.5	10 – 30	M8 × 1	Metal	2 m connection cable	Flush	LSI-R8S-F1-LD 281962	1 off
	S	1.5			Metal	Plug-in connection M12 x 1	Flush	LSI-R8S-F1-PD 281963	
	S	3			Metal	Plug-in connection M12 x 1	Non-flush	LSI-R8S-NF3-PD 281964	
	S	2		M12 × 1	Insulated material	2 m connection cable	Flush	LSI-R12P-F2-LD 281908	
	S	4			Insulated material	2 m connection cable	Non-flush	LSI-R12P-NF4-LD 281909	
	S	2			Metal	2 m connection cable	Flush	LSI-R12M-F2-LD 281904	
	S	2			Metal	Plug-in connection M12 x 1	Flush	LSI-R12M-F2-PD 281905	
	S	4			Metal	Plug-in connection M12 x 1	Non-flush	LSI-R12M-NF4-PD 281906	
	S	5		M18 × 1	Insulated material	2 m connection cable	Flush	LSI-R18P-F5-LD 281954	
	S	8			Insulated material	2 m connection cable	Non-flush	LSI-R18P-NF8-LD 281955	
	S	5			Metal	2 m connection cable	Flush	LSI-R18M-F5-LD 281950	
	S	5			Metal	Plug-in connection M12 x 1	Flush	LSI-R18M-F5-PD 281951	
	S	8			Metal	Plug-in connection M12 x 1	Non-flush	LSI-R18M-NF8-PD 281952	
	S	10		M30 × 1.5	Insulated material	2 m connection cable	Flush	LSI-R30P-F10-LD 281960	
	S	15			Insulated material	2 m connection cable	Non-flush	LSI-R30P-NF15-LD 281961	
	S	10			Metal	2 m connection cable	Flush	LSI-R30M-F10-LD 281956	
	S	10			Metal	Plug-in connection M12 x 1	Flush	LSI-R30M-F10-PD 281957	
	S	15			Metal	Plug-in connection M12 x 1	Non-flush	LSI-R30M-NF15-PD 281958	
	W	20	10 – 65	114 × 40 × 40	Insulated material	Screw terminal	Flush	LSI-Q40P-F20-CD 281998	
	W	40	10 – 65	114 × 40 × 40	Insulated material	Screw terminal	Non-flush	LSI-Q40P-NF40-CD 282002	
	S	20	10 – 30	65 × 40 × 40	Insulated material	Plug-in connection M12 x 1	Flush	LSI-Q40P-F20-PD 281999	
	S	35	10 – 30	65 × 40 × 40	Insulated material	Plug-in connection M12 x 1	Non-flush	LSI-Q40P-NF35-PD 282001	
AC voltage version 50/60 Hz V AC									
	S	2	20 – 250	M12 × 1	Insulated material	2 m connection cable	Flush	LSI-R12P-F2-LA 281907	
	S	5	20 – 250	M18 × 1	Insulated material	2 m connection cable	Flush	LSI-R18P-F5-LA 281953	
	S	10	20 – 250	M30 × 1.5	Insulated material	2 m connection cable	Flush	LSI-R30P-F10-LA 281959	
	P	20	20 – 250	114 × 40 × 40	Insulated material	Screw terminal	Flush	LSI-Q40P-F20-CA 281997	
	P	35	20 – 250	114 × 40 × 40	Insulated material	Screw terminal	Non-flush	LSI-Q40P-NF35-CA 282000	

Proximity switches



Contacts	Rated switching distance S_n mm	Rated operating voltage U_e V DC	Style mm	Housing	Connection type	Part no. Article no.	Price see price list	Std. pack
N/O = normally open contact, C/O = changeover contact, P = programmable as N/C or N/O								

LSC Capacitive proximity switches

Rated operational current I_{emax} . 200 mA
Fitting in metal: flush

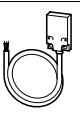
	N/O	3	10 – 30	M12 × 1	Metal	2 m connection cable	LSC-R12M-F3-LD 282005	1 off
	N/O	5	10 – 65	M18 × 1			LSC-R18M-F5-LD 282006	
	C	10	10 – 65	M30 × 1.5			LSC-R30M-F10-LD 282007	
	N/O	5	10 – 30	32 × 20 × 8	Insulated material	Screw terminal	LSC-Q20M-F5-LD 282003	
	C	20	10 – 65	114 × 40 × 40			LSC-Q40P-F20-CD 282004	

Operating range	Style	Housing	Terminal connection	Part no. Article no.	Price see price list	Std. pack
S_d	mm	mm				

LSO Optical proximity switches

Rated operating voltage U_e 10 – 30 V DC
Rated operational current I_{emax} . 150 mA
Output function M/B, programmable

Reflected-light beam





	300	M18 × 1	Insulated material	2 m connection cable	LSO-R18P-S300-LD 281987	1 off
	300	M18 × 1	Insulated material	Plug-in connection M12 x 1	LSO-R18P-S300-PD 281988	
	300	M18 × 1	Metal	2 m connection cable	LSO-R18S-S300-LD 281991	
	300	M18 × 1	Metal	Plug-in connection M12 x 1	LSO-R18S-S300-PD 281992	
With background suppression	400	M30 × 1.5	Insulated material	2 m connection cable	LSO-R30P-S400-LD 281995	
	400	M30 × 1.5	Insulated material	Plug-in connection M12 x 1	LSO-R30P-S400-PD 281996	

Reflected-light barrier
For combination with light-barrier reflector R...-ATL

	2000	M18 × 1	Insulated material	2 m connection cable	LSO-R18P-B2000-LD 281985	1 off
	2000	M18 × 1	Insulated material	Plug-in connection M12 x 1	LSO-R18P-B2000-PD 281986	
	2000	M18 × 1	Metal	2 m connection cable	LSO-R18S-B2000-LD 281989	
	2000	M18 × 1	Metal	Plug-in connection M12 x 1	LSO-R18S-B2000-PD 281990	
With polarisation filter	6000	M30 × 1.5	Insulated material	2 m connection cable	LSO-R30P-B6000-LD 281993	
With polarisation filter	6000	M30 × 1.5	Insulated material	Plug-in connection M12 x 1	LSO-R30P-B6000-PD 281994	



					Part no. Article no.	Price see price list	Std. pack
Light-barrier reflectors							
For combination with reflected-light barrier							
		Diameter: 40 mm			LSO-XR40 281983		1 off
		Diameter: 75 mm			LSO-XR75 281984		1 off
Length	Style input side	Style output side	Rated operating voltage	LED display	Part no. Article no.	Price see price list	Std. pack
m			U_e V				
Accessories: Plug and coupling, M12, "A" coded							
3-pole	1	Coupling, angled	Plug, straight	10 – 30	●	LSI-X3M-CAPS1-D4Y 281967	1 off
	2		Cable end open	10 – 30	●	LSI-X3M-CA2-D4Y 281965	
	5		Cable end open	10 – 30	●	LSI-X3M-CA5-D4Y 281966	
	1	Coupling, straight	Plug, straight	≅ 250		LSI-X3M-CSPS1-A4N 281969	
	1.5			≅ 250		LSI-X3M-CSPS1,5-A4N 281968	
	2			≅ 250		LSI-X3M-CSPS2-A4N 281970	
	5			≅ 250		LSI-X3M-CSPS5-A4N 281971	
4-pole	1	Coupling, angled	Plug, straight	10 – 30	●	LSI-X4M-CAPS1-D4Y 281974	1 off
	1	Coupling, straight	Plug, straight	≅ 250		LSI-X4M-CSPS1-A4N 281976	
	1.5			≅ 250		LSI-X4M-CSPS1,5-A4N 281975	
	2	Coupling, angled	Cable end open	≅ 250		LSI-X4M-CA2-A4N 281972	
	2	Coupling, straight	Cable end open	≅ 250		LSI-X4M-CS2-A4N 281973	
	2	Coupling, straight	Plug, straight	≅ 250		LSI-X4M-CSPS2-A4N 281977	
	5			≅ 250		LSI-X4M-CSPS5-A4N 281978	
				Plug, angled	Free	≅ 250	
		Plug, straight	≅ 250			LSI-X4M-PSF-A4N 281980	
		Coupling, angled	≅ 250			LSI-X4P-CAF-A4N 281981	
	Coupling, straight		≅ 250		LSI-X4P-CSF-A4N 281982		



Cut-in pressure and cut-out pressure: **separate** stepless adjustment. All the intersection points within the diagram area can be set.

Max. operating pressure
bar

Part no.
Article no.

Price see price list

Std. pack

Notes

Pressure switches with main contacts IP65, 3 pole

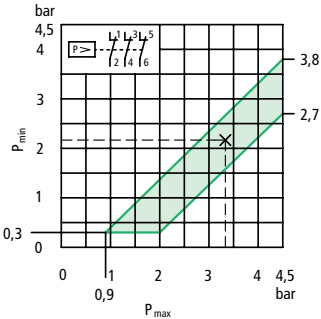
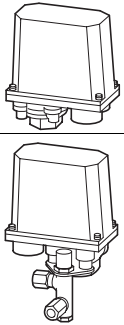

Variable switching differential

7

MCSN4
057679

1 off

- Features:
- With terminal cover as standard
 - 1 insulated earth terminal \oplus
 - One insulated N terminal
 - Two cable entry knockouts for M20, without cable gland
 - IP65 in conjunction with V-M20 cable gland
 - Pressure pipe flange R 1/2"
 - when requested: pressure pipe flange R 1/4"
 - Neoprene diaphragm

Min. switching differential: 0.6 bar
Example:
Cut-out pressure 3.3 bar
Cut-in pressure 2.2 bar

With release valve for 6 mm Ermeto coupling

7

MCSN4-V
062425

R 1/4" corresponds to G 1/4
R 1/2" corresponds to G 1/2 to ISO 228-1

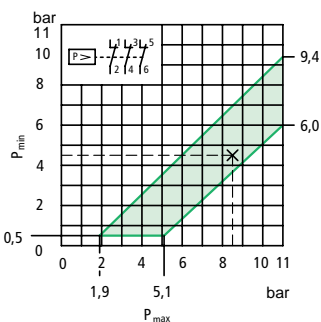
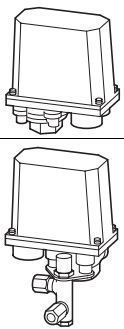

Variable switching differential

15

MCSN11
029203

For use as motor switch to IEC/EN 60947-4-1 for:

AC-3

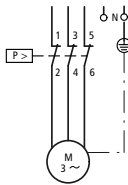

Min. switching differential: 1.4 bar
Example:
Cut-out pressure 8.5 bar
Cut-in pressure 4.5 bar

With release valve for 6 mm Ermeto coupling

15

MCSN11-V
033949

Single-phase current

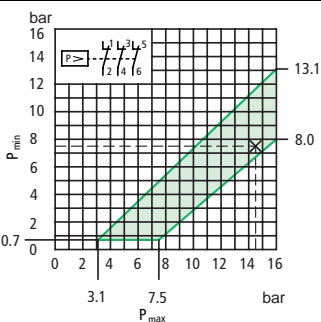
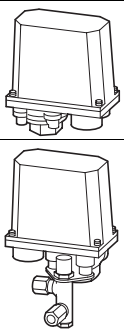
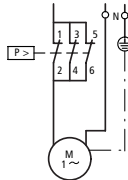

Variable switching differential

25

MCSN16
038695

DC-3

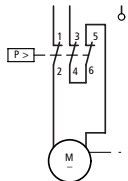

Min. switching differential: 2.4 bar
Example:
Cut-out pressure 14.5 bar
Cut-in pressure 7.5 bar

With release valve for 6 mm Ermeto coupling

25

MCSN16-V
043441

For use as control switch:

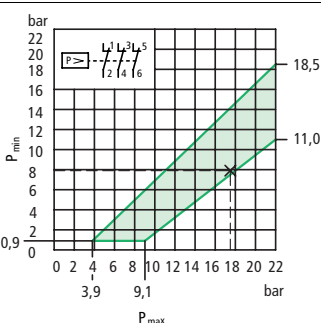
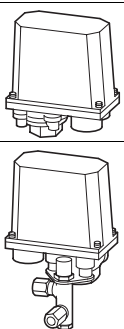
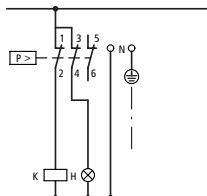

Variable switching differential

25

MCSN22
048187

Cut-in and cut-out pressures are factory-preset as specified with type suffix.

With release valve for 6 mm Ermeto coupling

25

MCSN22-V
052933

Min. switching differential: 3.0 bar
Example:
Cut-out pressure 17.5 bar
Cut-in pressure 7.8 bar





Contacts

Max. operating pressure

Make and break pressure: **separately** infinitely adjustable. Pressures can be set to any point within the area of the pressure diagram for the appropriate switch.

Part no. Article no.

Price see price list

Std. pack

Notes

Number

bar

Pressure switch with auxiliary contacts, IP65

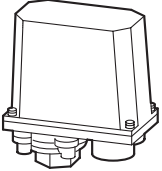

1 changeover contact

7

1 changeover contact with gold-plated contacts

7

2 changeover contacts with gold-plated contacts

7

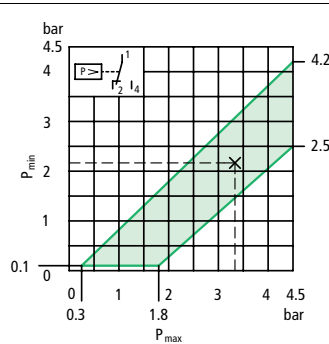

MCS4 019711

MCS4-G 058693

MCS4-SOND910-G 087792

1 off

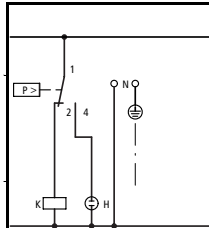

Features:

- Pressure pipe flange R 1/4"
- If required: pressure pipe flange R 1/2"
- IP65 in conjunction with V-M20 cable gland
- 1 insulated earth terminal ⊕
- 2 cable entry knockouts for M20
- Neoprene diaphragm

Cut-in and cut-out pressures are factory-preset as specified with type suffix:
→ page 3/20

1 changeover contact

15

1 changeover contact with gold-plated contacts

15

2 changeover contacts with gold-plated contacts

15

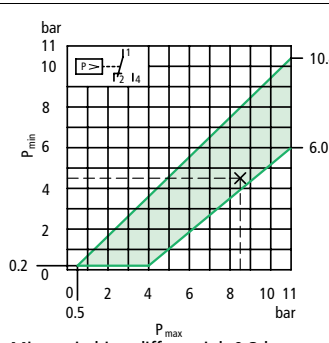

MCS11 088527

MCS11-G 058692

MCS11-SOND910-G 087793

1 off

R 1/4" corresponds to G 1/4
R 1/2" corresponds to G 1/2 according to ISO 228-1

Auxiliary contacts to IEC/EN 60947-1

MCS...-G: Gold-plated contacts, particularly suitable for switching low voltages and currents from 5 V AC/DC 1 mA.

1 changeover contact

25

1 changeover contact with gold-plated contacts

25

2 changeover contacts with gold-plated contacts

25

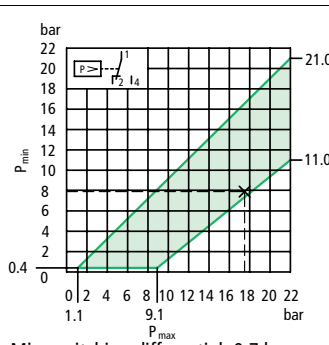



MCS22 098019

MCS22-G 058691

MCS22-SOND910-G 087794

1 off

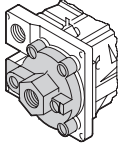
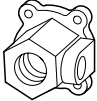
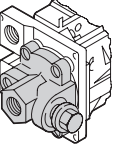
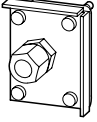
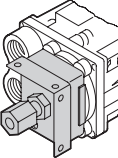

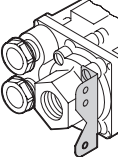
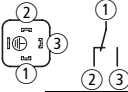
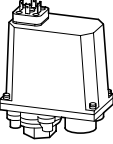
For use with	Part no. Order number for separate orders	Price see price list	Part no. suffix Order number for orders with basic unit	Price see price list	Std. pack	Notes
Pressure pipe flange						
Other than standard version						
	MCS with R 1/2"	R1/2"-MCS 031617	+R1/2"-MCS 001627		1 off	
	MCSN(-V) with R 1/4"	R1/4"-MCSN 033990	+R1/4"-MCSN 001628		1 off	
Pressure pipe flange with pressure gauge connection						
	MCS, MCSN(-V)	M-MCS 071913	+M-MCS 001625		1 off	 Manometer connection R 1/4", Pressure pipe flange always R 1/2" also with MCS
Compression fitting						
	MCS, MCSN	E8-MCS 040949	+E8-MCS 001624		1 off	 External diameter pipe coupling 8 mm Wall fixing bracket built-in, reversible by 180°
Wall fixing brackets						
	MCS, MCSN	W-MCS 050665	+W-MCS 001631		1 off	 Wall mounting bracket can be rotated to right or left in 90° stages
External device plug, IP65						
3-pole plus earth for socket adapters to DIN 43650-A/ISO 4400 Plug configuration:						
						
	MCS MCS...-G Not for use with MCS...SOND910-G		+S3-MCS 201854		1 off	-
Pressure setting						
Standard setting of the cut-in and cut-out pressures When ordering, the type reference must include the following details: 1st wildcard Δ cut-in pressure in bar 2nd wildcard Δ switch-off pressure in Bar						
MCS, MCSN			+PMIN(*)/PMAX(*) 203948		1 off	

Notes**Ordering example**

- Desired part no.: MCS4
 - Required cut-in pressure in bar: 2.2
 - Required cut-out pressure in bar: 3
- A maximum of one decimal place after the comma is possible with the pressure definition.



LSE-11



LSE-02

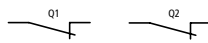

Basic units

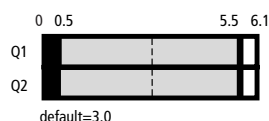
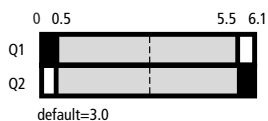

Operating heads

Roller plunger

- LS-XP
- LSM-XP
- PLS-XOR

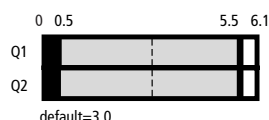
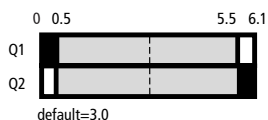

Roller lever

- LS-XL
- LSM-XL
- LS-XL
- LS-XLB

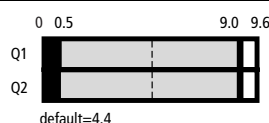
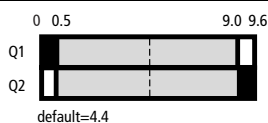

Angled roller lever

- LS-XLA
- LSM-XLA

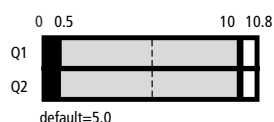
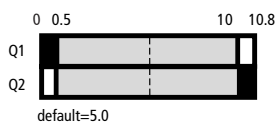

Rotary lever

- LS-XRL
- LSM-XRL

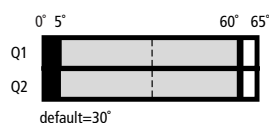
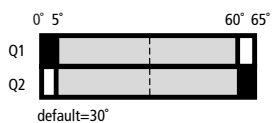

Adjustable roller lever

- LS-XRLA
- LSM-XRLA
- LS-XRLA30
- LS-XRLA40
- LS-XRLA40R

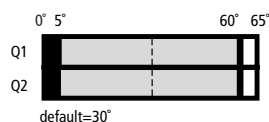
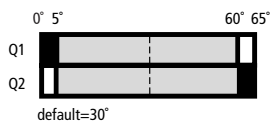

Actuating rod

- LS-XRR
- LSM-XRR
- LS-XRRM
- LSM-XRRM

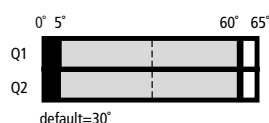
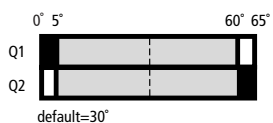

Spring-rod

- LS-XS
- LSM-XS

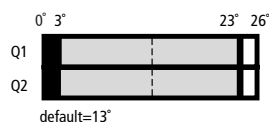

LS-02
LS-S02
LSM-02

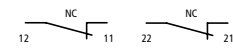

LS-11
LS-S11
LSM-11

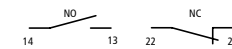

LS-11D
LS-S11D
LSM-11D

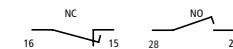

Basic units

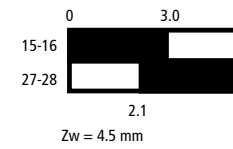
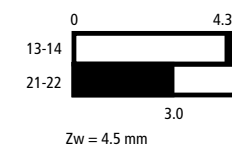
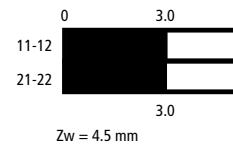

Operating heads

Roller plunger

LS-XP
LSM-XP

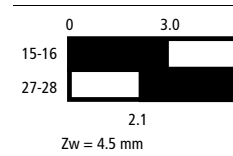
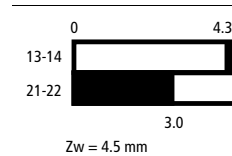
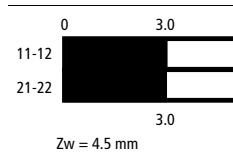

Roller lever

LS-XL, LSM-XL

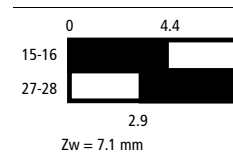
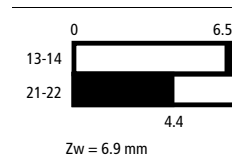
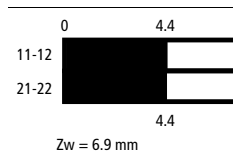

Roller lever, short
LS-XLS

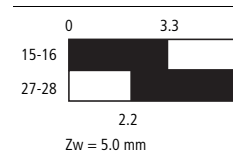
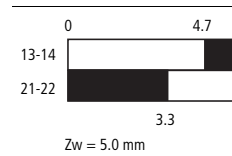
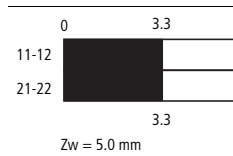

Roller lever, large
LS-XLB

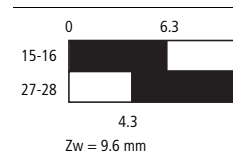
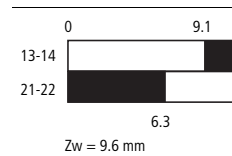
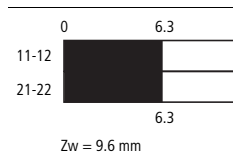

Angled roller lever

LS-XLA, LSM-XLA

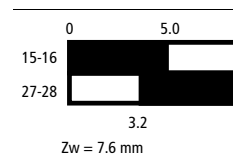
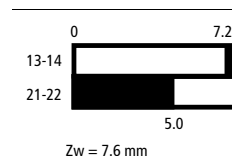
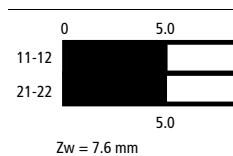

Rotary lever

LS-XRL, LSM-XRL

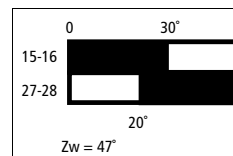
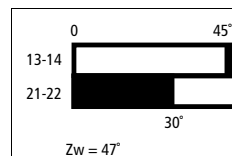

Adjustable roller lever

LS-XRLA, LSM-XRLA,
LS-XRLA30, LS-XRLA40,
LS-XRLA40R

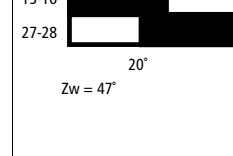
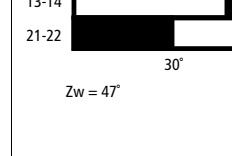
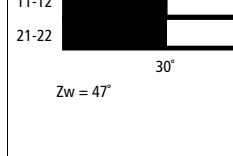

Actuating rod

LS-XRR, LSM-XRR,
LS-XRRM, LSM-XRRM

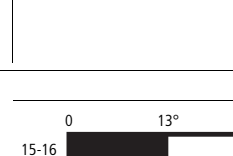
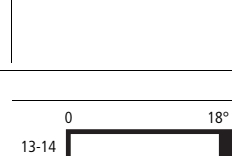
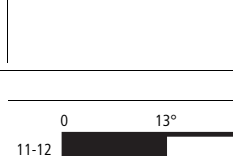

Spring-rod

LS-XS, LSM-XS

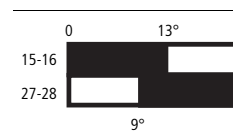
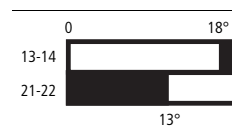
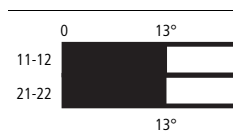

LS-11DA
LS-S11DA
LSM-11DA

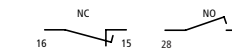

LS-11S
LS-S11S
LSM-11S

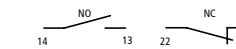

LS-20
LS-S20
LSM-20

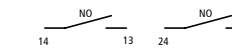

LS-20A
LS-S20A
LSM-20A

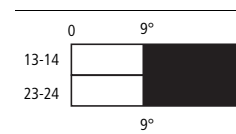
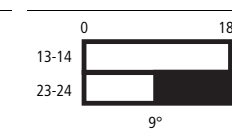
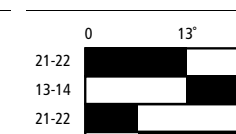
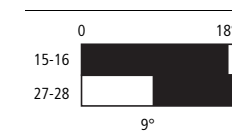
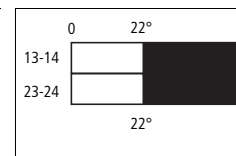
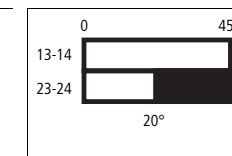
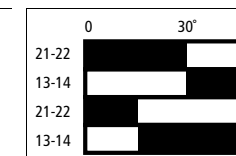
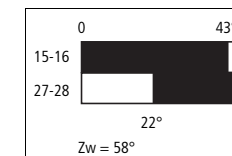
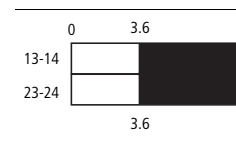
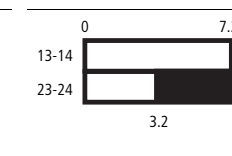
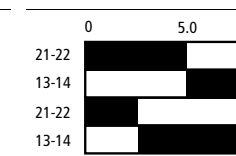
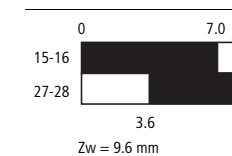
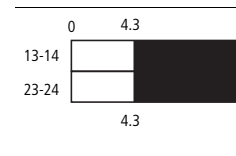
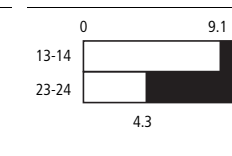
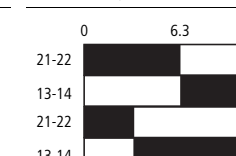
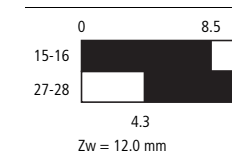
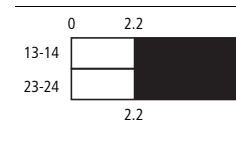
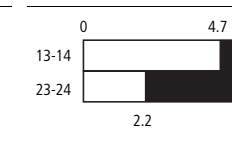
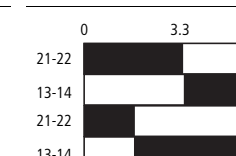
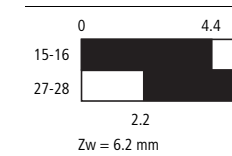
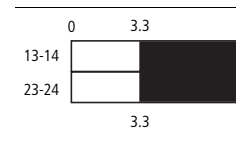
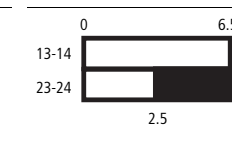
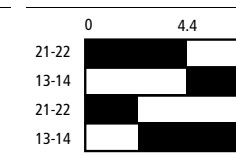
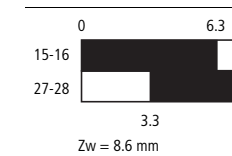
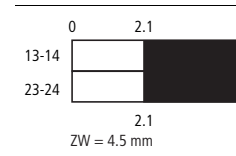
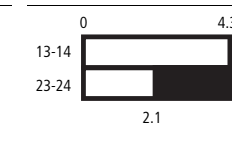
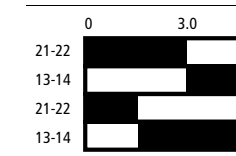
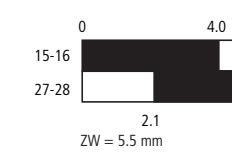
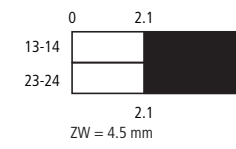
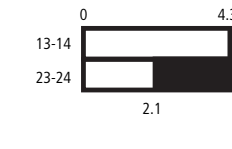
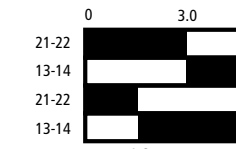
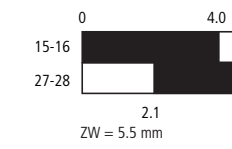
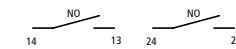

Position switch

Position switch



Position switch



LSI-R85-F1-LD
LSI-R12M-F2-LD
LSI-R12P-F2-LD
LSI-R12P-NF4-LD
LSI-R18M-F5-LD
LSI-R18P-F5-LD
LSI-R18P-NF8-LD
LSI-R30M-F10-LD
LSI-R30P-F10-LD
LSI-R30P-NF15-LD
LSC-R12M-F3-LD
LSC-R18M-F5-LD
LSC-Q20M-F5-LD

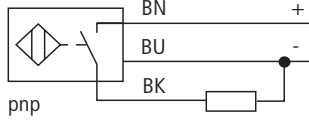

LSI-*-LD with 2 m connection cable (open end)

Changing the active area
LSI-Q40P-...-CA

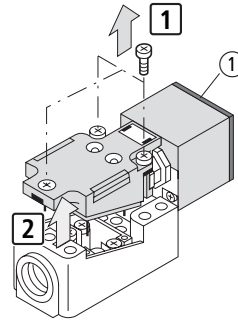

LSI-R85-F1-PD
LSI-R85-NF3-PD
LSI-R12M-F2-PD
LSI-R12M-NF4-PD
LSI-R18M-F5-PD
LSI-R18M-NF8-PD
LSI-R30M-F10-PD
LSI-R30M-NF15-PD
LSI-Q40P-F20-PD
LSI-Q40P-NF35-PD

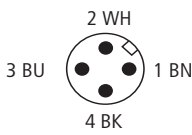
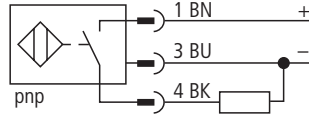

LSI-*-PD with M12 x 1 plug-in connection

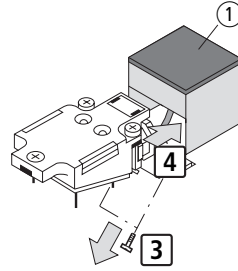

LSI-R12P-F2-LA
LSI-R18P-F5-LA
LSI-R30P-F10-LA

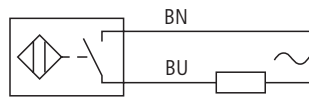

LSI-*-LA with 2 m connection cable (open end)

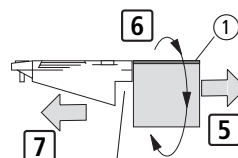

LSI-Q40P-F20-CA
LSI-Q40P-NF35-CA

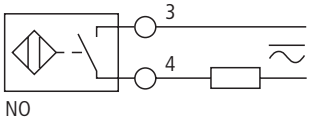

LSI-*-CA Terminal connection inside enclosure

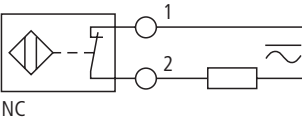

LSC-Q40P-F20-CD
LSC-R30M-F10-LD

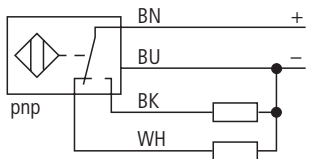

LSC-*-LD with 2 m connection cable (open end)
LSC-*-CD Terminal connection inside enclosure

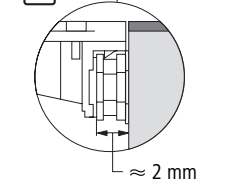

LSO-R18P-B2000-LD
LSO-R18P-B2000-PD
LSO-R18P-S300-LD
LSO-R18P-S300-PD
LSO-R18S-B2000-LD
LSO-R18S-B2000-PD
LSO-R18S-S300-LD
LSO-R18S-S300-PD
LSO-R30P-B6000-LD
LSO-R30P-B6000-PD
LSO-R30P-S400-LD
LSO-R30P-S400-PD

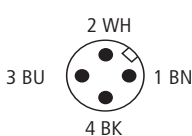
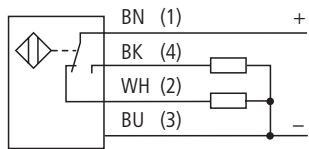

LSO-*-LD with 2 m connection cable (open end)
LSO-*-PD with M12 x 1 plug-in connector

LSI-Q40P-...-PD

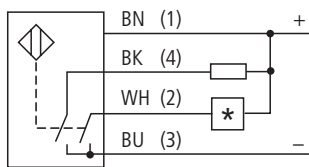
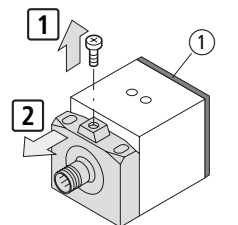

LSI-*-CD Terminal connection inside enclosure

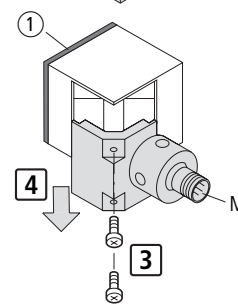

Notes

BN \triangle brown
BK \triangle black
BU \triangle blue
WH \triangle white

Set position of cable exit

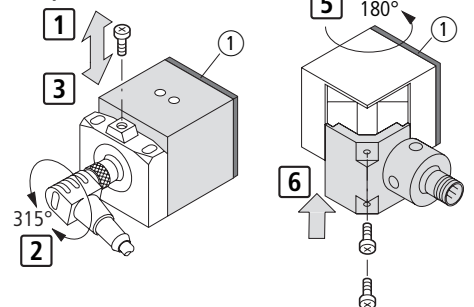

				IP66, IP67 complete units			
				LS, LSM	LSE-11 LSE-02	LSE-AI	LSE-AU
General							
Standards				IEC/EN 60947	IEC/EN 60947 EN 61000-4	IEC/EN 60947 EN 61000-4	IEC/EN 60947 EN 61000-4
Climatic proofing				Damp heat, constant, to IEC 60068-2-78; damp heat, cyclical, to IEC 60068-2-30			
Ambient temperature			°C	-25...+70	-25...+70	-25...+70	-25...+70
Mounting position				As required	As required	As required	As required
Protection type				IP66, IP67	IP66, IP67	IP66, IP67	IP66, IP67
Terminal capacity of screw terminal and Cage Clamp							
Solid			mm ²	1 × (0.5 – 2.5)	1 × (0.5 – 2.5)	1 × (0.5 – 2.5)	1 × (0.5 – 2.5)
Flexible with ferrules to DIN 46228			mm ²	1 × (0.5 – 1.5)	1 × (0.5 – 1.5)	1 × (0.5 – 1.5)	1 × (0.5 – 1.5)
Power supply							
Rated voltage			U_e V DC		12 – 30	24 (-15%/+20%)	24 (-15%/+20%)
Rated operational current							
12 V			I_e mA		15		
24 V			I_e mA		18	28 – 45	24
30 V			I mA		19		
Contacts/switching capacity							
Rated impulse withstand voltage			U_{imp} V AC	4000			
Rated insulation voltage			U_i V	400			
Overvoltage category/pollution degree				III/3	III/3		
Rated operational current							
AC-15	24 V		I_e A	6			
	230 V/240 V		I_e A	6			
	400 V/415 V		I_e A	4			
DC-13	24 V		I_e A	3	0.2		
	110 V		I_e A	0.8			
	220 V		I_e A	0.3			
Analog output Q1							
Output voltage (max. 10 mA)			V DC				0 – 10
Output current			mA			4 – 20	
Fault scenario			V			0	0
Resolution				Steps		100	100
Step tolerance				Steps		1	1
Shunt resistor, resistive load			Ω			< 400	> 1000
Digital diagnostics output Q2 (switching to + pole PNP)							
Response threshold			V mA			approx. U_e < 200	approx. U_e < 200
Control circuit reliability							
at 24 V DC/5 mA			H_f Fault probability	< 10 ⁻⁷ , < 1 fault in 10 ⁷ operations			
at 5 V DC/1 mA			H_f Fault probability	< 10 ⁻⁶ , < 1 failure at 5 × 10 ⁶ operations			
Supply frequency				Hz	max. 400		
Short-circuit rating to IEC/EN 60947-5-1							
max. fuse			A gG/gL	6			
Repetition accuracy			mm	± 0.02	± 0.02	± 0.02	± 0.02

Notes

The following applies for LSE-11 and LSE-02: ensure that the power supply operates correctly when setting the operating point.

Cage Clamp is a registered trademark of Wago Kontakttechnik, 32423 Minden, Germany.
Accessories for the Cage Clamp terminals from Wago:
Jumper insert, grey, Wago article no. 264-402





				IP66, IP67 complete units			
				LS, LSM	LSE-11 LSE-02	LSE-AI LSE-AU	LSE-AI LSE-AU
Mechanical variables							
Lifespan							
Standard-action contact	Operations	$\times 10^6$	8				
Snap-action contact	Operations	$\times 10^6$	8	3 (electronic)			
Contact temperature of roller head		°C	≤ 100	≤ 100	≤ 100	≤ 100	≤ 100
Mechanical shock resistance (half-sinusoidal shock, 20 ms)							
Standard-action contact		g	25				
Snap-action contact		g					
Basic unit		g		30	30		30
Operating frequency	Operations/h		≤ 6000	≤ 3000	≤ 3000	≤ 3000	≤ 3000
Switching point				0.5 – 5.5 mm, freely adjustable			
Hysteresis		mm		0.4	0.4		0.4
Contact sequence (contact closed open Zw = positive opening clearance)		mm		0.04	0.06		0.06
Actuation							
Mechanical							
Actuating force at beginning/end of stroke							
Basic units		N	1.0/8.0	3.5/8.0	3.5/8.0		3.5/8.0
LS(M)-XP		N	1.0/8.0	1.0/8.0	1.0/8.0		1.0/8.0
LS(M)-XL		N	1.0/8.0	1.0/8.0	1.0/8.0		1.0/8.0
LS(M)-XLA		N	1.0/8.0	1.0/8.0	1.0/8.0		1.0/8.0
Actuating torque of rotary drives		Nm	0.2	0.2	0.2		0.2
Max. operating speed with DIN cam							
Basic units for angle of actuation	$\alpha = 0^\circ/30^\circ$	m/s	1/0.5	1/0.5	1/0.5		1/0.5
LS(M)-XRL for angle of actuation	$\alpha = 0^\circ$	m/s	1.5	1.5	1.5		1.5
LS(M)-XRLA for angle of actuation	$\alpha = 30^\circ, L = 125 \text{ mm}$	m/s	1.5	1.5	1.5		1.5
LS(M)-XRR for	$L = 130 \text{ mm}$	m/s	1.5	1.5	1.5		1.5
LS(M)-XL for angle of actuation	$\alpha = 30^\circ/45^\circ$	m/s	1	1	1		1
LS(M)-XLA for angle of actuation	$\alpha = 30^\circ/45^\circ$	m/s	1	1	1		1
LS(M)-XP for angle of actuation	$\alpha = 0^\circ/30^\circ$	m/s	1/1	1/1	1/1		1/1
Electromagnetic compatibility (EMC)							
Electrostatic discharge (IEC/EN 61000-4-2, Level 3, ESD)							
Air discharge		kV		8	8		8
Contact discharge		kV		4	4		4
Electromagnetic fields (IEC/EN 61000-4-3, RFI)		V/m		10	10		10
Burst pulses (IEC/EN 61000-4-4, level 3)							
Supply cables		kV		2	2		2
Signal lines		kV		2	2		2
High-energy pulses (surge) (IEC/EN 61000-4-5)		kV		0.5	0.5		0.5
Immunity to line-conducted interference to (IEC/EN 61000-4-6)		V		10	10		10

Notes

The following applies for LSE-11 and LSE-02: ensure that the power supply operates correctly when setting the operating point.

Cage Clamp is a registered trademark of Wago Kontakttechnik, 32423 Minden, Germany.
Accessories for the Cage Clamp terminals from Wago:
Jumper insert, grey, Wago article no. 264-402

				Connector M12A(B)	M12A(B)5
General					
No. of poles				4	5
Protection type				IP66	IP66
Lifespan, mechanical	Operations			> 500	> 500
Characteristics					
Rated operational voltage	U_e	V AC		250	125
Rated operational current	I_e	A		4	4
Overvoltage category/pollution degree				II/3	II/3

				Safety position switches		
				LS-...ZBZ	LS-...ZB	LS4...ZB
General						
Standards				IEC/EN 60947		
Climatic proofing				Damp heat, constant, to IEC 60068-2-78; damp heat, cyclical, to IEC 60068-2-30		
Ambient temperature			°C	-25...+0	-25...+70	-25...+70
Mounting position				As required		
Protection type				IP 65		
Terminal capacities						
Solid			mm ²	1 × (0.75 – 2.5) 2 × (0.75 – 1.5)	1 × (0.75 – 2.5) 2 × (0.75 – 1.5)	1 × (0.75 – 2.5) 2 × (0.75 – 1.5)
Flexible with ferrule			mm ²	1 × (0.5 – 1.5) 2 × (0.5 – 1.5)	1 × (0.5 – 1.5) 2 × (0.5 – 1.5)	1 × (0.5 – 1.5) 2 × (0.5 – 1.5)
Contacts/switching capacity						
Rated impulse withstand voltage			U_{imp}	V AC	4000	6000
Rated insulation voltage			U_i	V	400	500
Overvoltage category/pollution degree				III/3	III/3	III/3
Rated operational current						
AC-15	24 V	I_e	A	6	10	10
	230 V/240 V	I_e	A	6	6	6
	400 V/415 V	I_e	A	4	4	4
DC-13	24 V	I_e	A	3	3	3
	110 V	I_e	A	0.8	0.8	0.8
	220 V	I_e	A	0.3	0.3	0.3
Supply frequency				Hz	max. 400	max. 400
Short-circuit rating to IEC/EN 60947-5-1						
max. fuse			A gG/gL	6	6	6
Repetition accuracy				mm	± 0.02	± 0.02
Mechanical variables						
Lifespan						
Standard-action contact			Operations	× 10 ⁶	1	10
Snap-action contact			Operations	× 10 ⁶		10
Mechanical shock resistance (half-sinusoidal shock, 20 ms)						
Standard-action contact				g	10	25
Snap-action contact				g		5
Operating frequency				Operations/h	≦ 800	≦ 1800
Actuation						
Mechanical						
Actuating force at beginning/end of stroke						
ZB/ZBZ (push in/pull out)			N	25/15	10/5	15/20
Mechanical holding force acc. to GS-ET-19 (04/2004)						
XG, XW			N	1500		
XFF, XNG, XWA			N	1300		
XF			N	750		
XNW			N	500		
Electromechanical						
For magnet						
Power consumption						
at 120 V AC			VA	8		
at 230 V AC			VA	11		
at 24 V DC			W	8		
Pick-up and drop-out values				× U_s	0.85 – 1.1	
Magnet duty factor				% ED	100	



			DC voltage version (PNP)					
			LSI-R8...D	LSI-R12...D	LSI-R18...D	LSI-R30...D	LSI-Q40...-CD	LSI-Q40...-PD
General								
Standards			IEC/EN 60947-5-2					
Ambient temperature		°C	-25...+70	-25...+70	-25...+70	-25...+70	-25...+70	-25...+70
Protection type			IP 67	IP 67	IP 67	IP 67	IP 67	IP 67
Shock resistance Shock duration 11 ms		g	30	30	30	30	30	30
Characteristics								
Rated switching distance								
Flush	S_n	mm	1.5	2	5	10	20	20
Non-flush	S_n	mm	2	4	8	15	40	35
Repetition accuracy of S_n		%	2	2	2	2	2	2
Temperature drift of S_n		%	< 10	< 10	< 10	< 10	< 10	< 10
Switching hysteresis of S_n		%	15	15	15	15	15	15
Rated operating voltage	U_e	V DC	10 – 30	10 – 30	10 – 30	10 – 30	10 – 65	10 – 30
Rated operating voltage	U_e	V AC	–	–	–	–	–	–
Supply frequency	S_n	Hz						
Residual ripple of U_e		%	≤ 10	≤ 10	≤ 10	≤ 10	≤ 10	≤ 10
Operating current in the switched state at 24 V DC	I_b	mA	15	15	15	15	15	15
Maximum load current	I_e	mA	< 150	< 200	< 200	< 200	< 200	< 200
Voltage drop with I_e	U_d	V	1.8	1.8	1.8	1.8	1.8	1.8
Max. operating frequency (resistive load)	f	Hz	≤ 3000	≤ 2000	≤ 1000	≤ 500	≤ 150	≤ 150
Rated operational current min.	I_e	mA						
Short-time current (10 ms, 5 Hz)		A						
Residual current through the load in the blocked state at 230 V AC and 24 V DC	I_r	mA	0.1	0.1	0.1	0.1	0.1	0.1
Switching state display	LED		Yellow	Yellow	Yellow	Yellow	Yellow	Yellow
Operating voltage display	LED						Green	Green
Short-circuit protection, polarity reversal, wire breakage			●	●	●	●	●	●
Output function								
Two-wire								
Three-wire			●	●	●	●		●
Four-wire							●	
Make contact			●	●	●	●	●	●
Changeover contact							●	
Threaded barrel		mm	M8 × 1	M12 × 1	M18 × 1	M30 × 1.5	114 × 40 × 40	65 × 40 × 40
Threaded barrel			●	●	●	●		
Rectangular housing							●	●
Connection options								
Cable, open			●	●	●	●		
Connector M12, "A"-keyed			●	●	●	●		●
Enclosure material								
Plastic				PA	PA	PA	PBT	PBT
Metal			Stainless steel 1.4301	CuZn chromed	CuZn chromed	CuZn chromed		
Enclosure nut tightening torque								
Plastic		Nm	1	2	5			
Metal		Nm	10	10	25	90		
Installation note								
Sensor to sensor clearance								
Flush			2 × d	2 × d	2 × d	2 × d	2 × d	2 × d
Non-flush			3 × d	3 × d	3 × d	3 × d	4.5 × d	4.5 × d
Terminal capacities								
Solid		mm ²					≤ 2.5	

Proximity switches



Two-wire AC proximity switches				
LSI-R12...A	LSI-R18...A	LSI-R30...A	LSI-Q40...A	
IEC/EN 60947-5-2				
-25...+70	-25...+70	-25...+70	-25...+70	
IP 67	IP 67	IP 67	IP 67	
30	30	30	30	
2	5	10	20	
			35	
2	2			
< 10	< 10	< 10	< 10	
15	15	15	15	
20 – 250	20 – 250	20 – 250	20 – 250	
20 – 250	20 – 250	20 – 250	20 – 250	
50 – 60	5060	5060	5060	
< 100	< 400	< 400	< 400	
6	6	6	6	
≤ 20	≤ 20	≤ 20	≤ 20	
2	2	2	2	
1	8	8	8	
1.7	1.7	1.7	1.7	
Yellow	Yellow	Yellow	Red	
●	●	●	Programmable	
M12 × 1	M18 × 1	M30 × 1.5	114 × 40 × 40	
●	●	●		
			●	
●	●	●		
PA	PA	PA	PBT	
1	2	5		
2 × d	2 × d	2 × d	2 × d	
			≤ 2.5	

Notes

UL-File: E244290
 Rated switching distance S_n [mm] with LSI
 According to the standard, the rated switching distance S_n relates to a measurement control point made of St 37 which is 1 mm thick with the dimensions B 3 H.
 LSI...R: B x H = device diameter
 LSI...Q: B x H = edge length

- Deviation in the type, size and shape of the approaching metal object
- Ambient temperature
- Different alloys

Ideal band

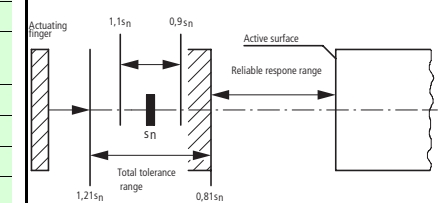

Correction factor with LSI:

Steel St 37		1.0	× S_n
Nickel chrome	Approx.	0.9	× S_n
Brass	Approx.	0.5	× S_n
Aluminium	Approx.	0.45	× S_n
Copper	Approx.	0.4	× S_n
Galvanized sheet steel	Approx.	0.85	× S_n
Stainless-steel depending on the alloy		1.0 0.1	– × S_n

Proximity switches





			DC voltage version (PNP)				
			LSC-R12M-F3-LD	LSC-R18M-F5-LD	LSC-R30M-F10-LD	LSC-Q20M-F5-LD	LSC-Q40P-F20-CD
General							
Standards			IEC/EN 60947-5-2	IEC/EN 60947-5-2	IEC/EN 60947-5-2	IEC/EN 60947-5-2	IEC/EN 60947-5-2
Ambient temperature		°C	-25...+70	-25...+70	-25...+70	-25...+70	-25...+70
Protection type			IP 67	IP 67	IP 67	IP 67	IP 67
Shock resistance	Shock duration 11 ms	g	30	30	30	30	30
Characteristics							
Rated switching distance							
Flush	S_n	mm	3	5	10	5	20
Non-flush	S_n	mm	3	5	10	5	30
Repetition accuracy of S_n		%	2	2	2	2	2
Temperature drift of S_n		%	< 20	< 20	< 20	< 20	< 20
Switching hysteresis of S_n		%	20	20	20	20	20
Rated operating voltage	U_e	V DC	10 – 30	10 – 65	10 – 65	10 – 30	10 – 65
Residual ripple of U_e		%	≤ 10	≤ 10	≤ 10	≤ 10	≤ 10
Operating current in the switched state at 24 V DC	I_b	mA	15	15	15	15	15
Maximum load current	I_e	mA	< 200	< 200	< 200	< 200	< 200
Voltage drop with I_e	U_d	V	1.8	1.8	1.8	1.8	1.8
Max. operating frequency (resistive load)	f	Hz	≤ 100	≤ 100	≤ 100	≤ 100	≤ 100
Residual current through the load in the blocked state at 230 V AC and 24 V DC	I_r	mA	0.1	0.1	0.1	0.1	0.1
Switching state display		LED	Yellow	Yellow	Yellow	Yellow	Yellow
Operating voltage display		LED				Green	Green
Short-circuit protection, polarity reversal, wire breakage			●	●	●	●	●
Output function							
Three-wire			●	●		●	
Four-wire					●		●
Make contact			●	●		●	
Changeover contact					●		●
Style							
Threaded barrel		mm	M12 × 1	M18 × 1	M30 × 1.5	32 × 20 × 8	114 × 40 × 40
Threaded barrel			●	●	●		
Rectangular housing						●	●
Connection options							
Cable, open			●	●	●	●	
Terminal capacities							
Solid		mm ²					≤ 2.5
Enclosure material							
Plastic							PBT
Metal			CuZn chromed	CuZn chromed	CuZn chromed	GdZn	
Tightening torque							
Enclosure nut		Nm	10	25	25		

			DC voltage version (PNP)			
			Retro-reflective sensor		Diffuse mode sensor	
			LSO-R18...-B...	LSO-R30...-B...	LSO-R18...-S...	LSO-R30...-S...
General						
Standards			IEC/EN 60947-5-2	IEC/EN 60947-5-2	IEC/EN 60947-5-2	IEC/EN 60947-5-2
Ambient temperature		°C	-40...+70	-40...+70	-40...+70	-40...+70
Protection type			IP 67	IP 67	IP 67	IP 67
Characteristics						
Range		mm	2000	6000	300	400
Rated operating voltage	U_e	V DC	10 – 30	10 – 30	10 – 30	10 – 30
Maximum load current	I_e	mA	< 150	< 150	< 150	< 150
Operating current in the switched state at 24 V DC	I_b	mA	25	30	25	30
Max. operating frequency (resistive load)	f	Hz	≤ 160	≤ 160	≤ 160	≤ 160
Overcurrent release		mA	220	220	220	220
Readiness delay	t_v	ms	100	100	100	100
Switching state display		LED	Yellow	Yellow	Yellow	Yellow
Alarm display		LED	Yellow, flashing			
Operating voltage display		LED	Green	Green	Green	Green
Fault display		LED	Green, flashing	Green, flashing	Green, flashing	Green, flashing
Terminal connection			●	●	●	●
Style			Programmable	Programmable	Programmable	Programmable
Style						
Threaded barrel		mm	M18 × 1	M30 × 1.5	M18 × 1	M30 × 1.5
Connection options						
Cable, open			●	●	●	●
Connector M12, "A"-keyed			●	●	●	●
Enclosure material						
Plastic			PBT	PBT	PBT	PBT
Metal			Stainless steel 1.4301		Stainless steel 1.4301	
Enclosure nut tightening torque						
Plastic		Nm	5	5	5	5
Metal		Nm	25		25	

Notes

Switching range S_d [mm] with LSO

The switching range is defined conform to IEC/EN 60947-5-2. It relates to reflected-light beams on a white paper card with a 90 % degree of reflection and

- 100 mm edge length with $S_d < 400$ mm
- 200 mm edge length with $S_d \geq 400$ mm

Correction factor with LSO as an optical sensor:

- Paper, matt white, 200 g/m² $1.0 \times S_d$
- Metal, gloss $1.2...1.6 \times S_d$
- Aluminium, black anodized $1.1...1.8 \times S_d$
- Expanded polystyrene, white $1 \times S_d$
- Cotton, white $0.6 \times S_d$
- PVC, grey $0.5 \times S_d$
- Wood, untreated $0.4 \times S_d$
- Carton, black, gloss $0.3 \times S_d$
- Carton, black, matt $0.1 \times S_d$

Short-circuit protection monitored

DC-operated proximity switches are proof against short-circuit. The device is not damaged by the effects of a short-circuit. No matter how long its duration. Once the fault has been cleared, the switch is immediately ready for operation again.





				Pressure switches	
				MCS	MCSN
General					
Standards				IEC/EN 60947-5-1	
Test pressure		bar		32	32
Rupturing pressure		bar		90	90
Operating frequency	Operations/h			≤ 3000	≤ 1500
Climatic proofing					
Damp heat, constant to IEC 60068-2-78 Damp heat, cyclic to IEC 60068-2-30					
Ambient temperature		°C		-25...70	-25...70
Protection type				IP 65	IP 65
Mounting position				As required	As required
Mechanical shock resistance to IEC 60068-2-27	Half-sinusoidal shock 20 ms	g		> 10	> 10
Vibration resistance acc. to IEC/EN 60068-2-6	Amplitude 1 mm	Hz		36	36
Lifespan at 50 – 12% pressure differential	Operations	× 10 ⁶		1 – 2	0.5
Terminal capacities					
Solid		mm ²		1 × (0.75 – 2.5)	1 × (0.75 – 2.5) 2 × (0.75 – 2.5)
Flexible with ferrules to DIN 46228		mm ²		1 × (0.5 – 1.5)	1 × (0.5 – 1.5) 2 × (0.5 – 1.5)
Terminations				Tunnel terminal	Flat terminal with clamping washer
Terminal screw				M3	M4
Tightening torque of terminal screw		Nm		0.5	
Contacts/switching capacity					
Rated impulse withstand voltage	U_{imp}	V AC		4000	4000
Rated insulation voltage	U_i	V		400	400
Overvoltage category/pollution degree				III/3	III/3
Max. short-circuit protective device					
Fuseless		Type		PKZ2/ZM16	PKZ2/ZM16
Fuse	gG/gL	A		10	20
Type of coordination					
Rated operational current					
AC-15	230 V	A		2	
Rated operational current					
AC-3	230 V	A			15
	400 V	A			11.5
Rated operational current					
DC-13	24 V	A		2	
	110 V	A		0.5	
Rated operational current					
DC – 3	24 V	A			16
	110 V	A			12.5
	250 V	A			2
Rated frequency	f	Hz		50	50

Notes

The following applies to the rated operational current for DC-13:

- with 24 V: ...SOND910-G: 0.25 A
- with 110 V: ...SOND910-G: 0.8 A

Position switch

LS-..., LSM-..., LSE-...

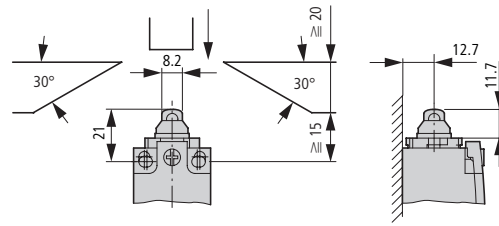
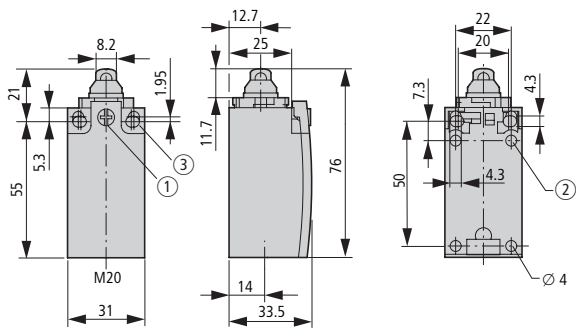

- ① Tightening torque of cover screws: 0.8 Nm ±0.2 Nm
 - ② only with LS (insulated version)
 - ③ Fixing screws 2 x M4 ≧ 30
- $M_A = 1.5 \text{ Nm}$

Position switch

LS(M)-.../P

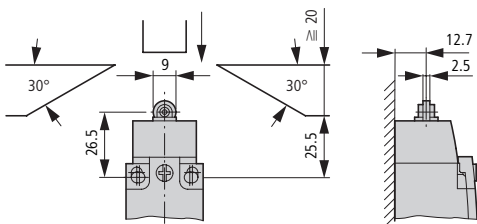

Rotary lever

LS(M)-.../RL

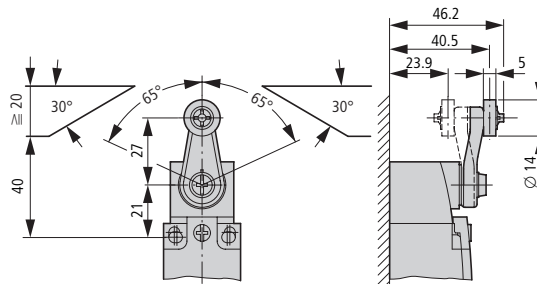

Adjustable roller lever

LS(M)-.../RLA

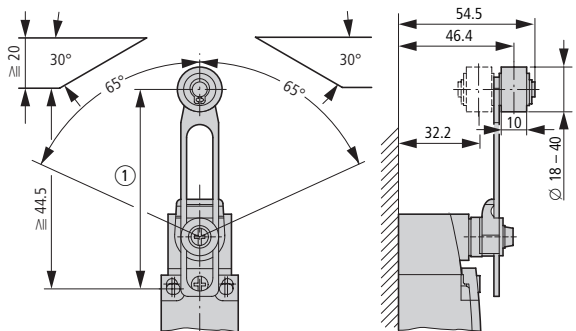

- ① setting range of 54.5 to 97

Position switches

LS(M)-.../S

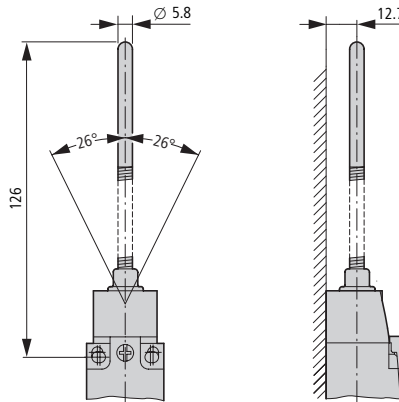

Roller lever

LS(M)-.../L

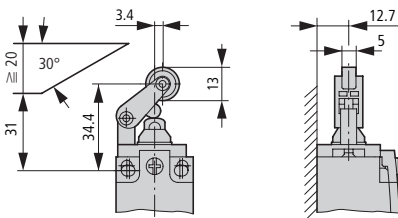

Actuating rod

LS(M)-.../RR

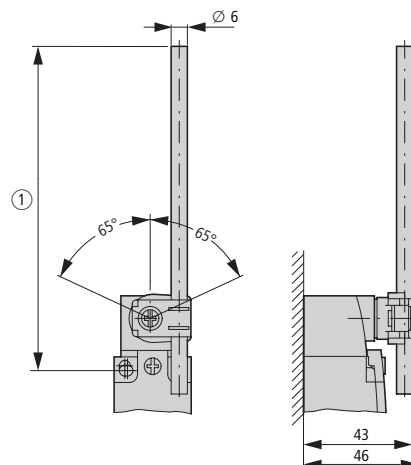

- ① LS.../RR ≧ 150
- LS.../RRM ≧ 210

Angled roller lever

LS(M)-XLA

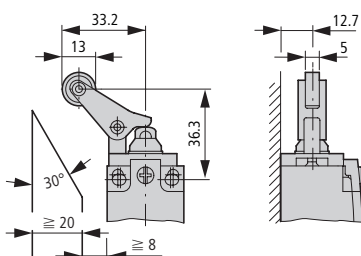

Front fixing, non expandable

LS(M)-.../F

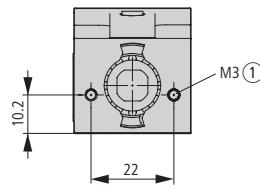
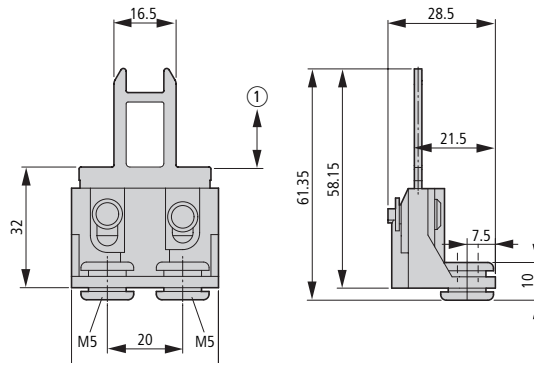

① screw-in depth max. 12 mm

Position switch

Actuating rod

LS(M)-.../OR

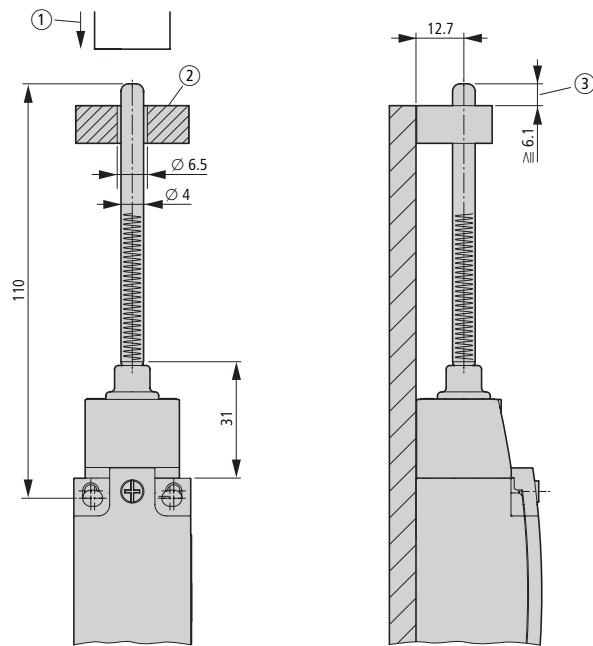

- ① Approach direction, vertical
- ② guide is done by customer, not included
- ③ max. push-through



Roller lever, large

LS(M)-.../LB

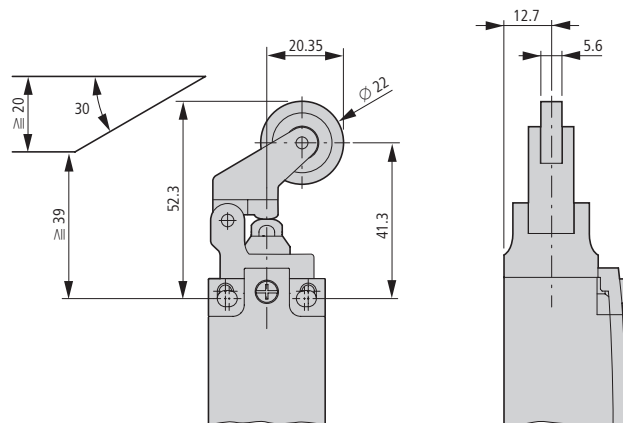

① Tightening torque of cover screws: 0.8 Nm ±0.2 Nm

Roller lever, short

LS(M)-.../LS

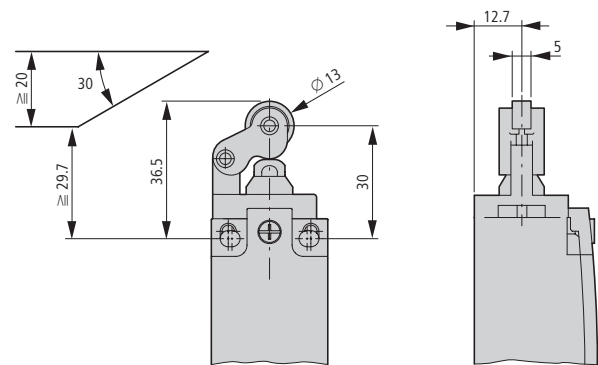

Safety position switches
LS...-ZBZ

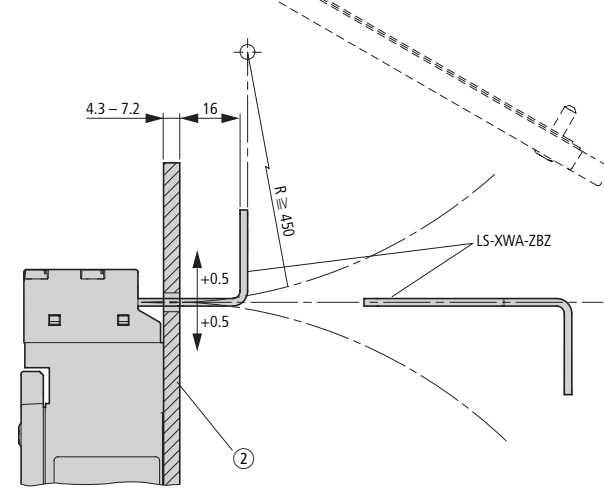
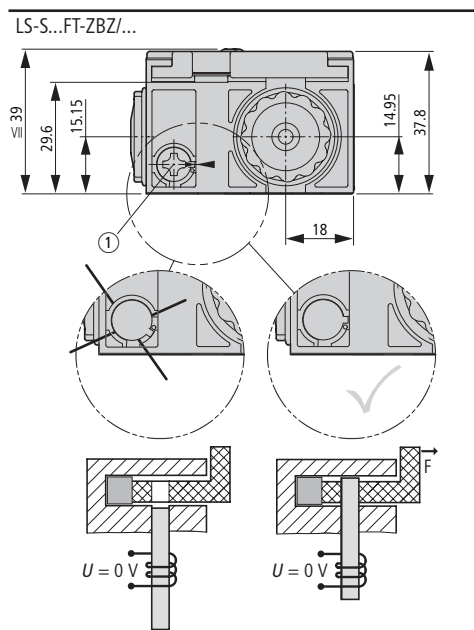
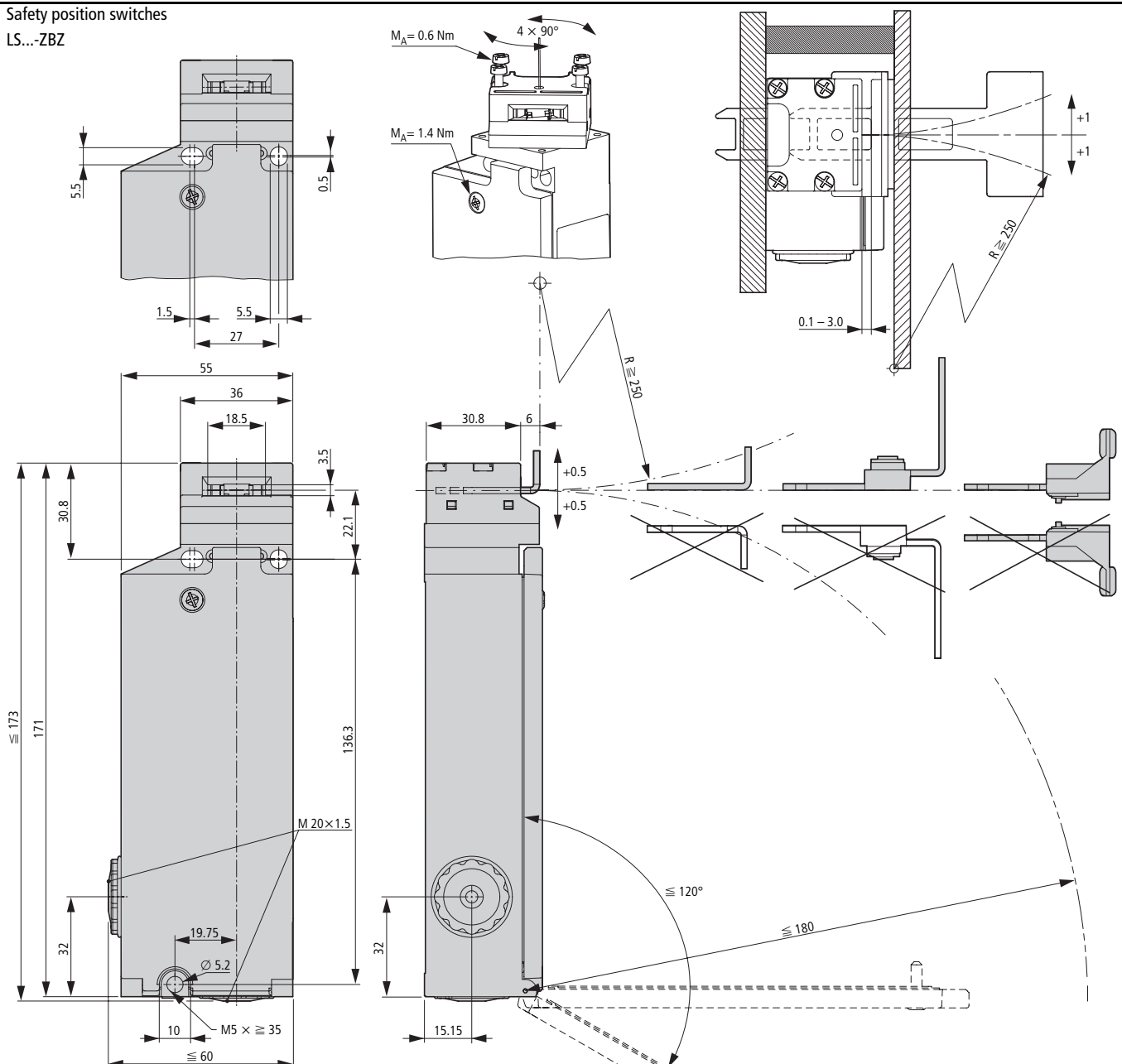

Switch must not be used as a mechanical stop.
 ① = the auxiliary release mechanism must be sealed for proper operation!
 ② can be used as stop with the corresponding material selection and design

Safety switches

Actuators

LS-XG-ZBZ

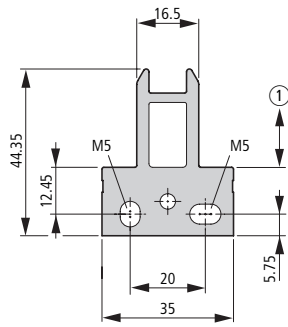

LS-XW-ZBZ

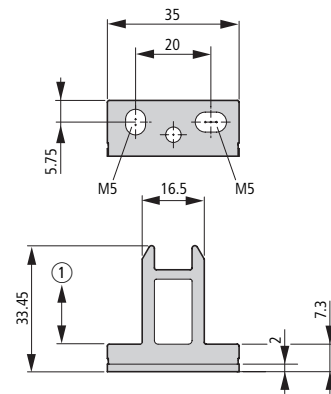

LS-XF-ZBZ

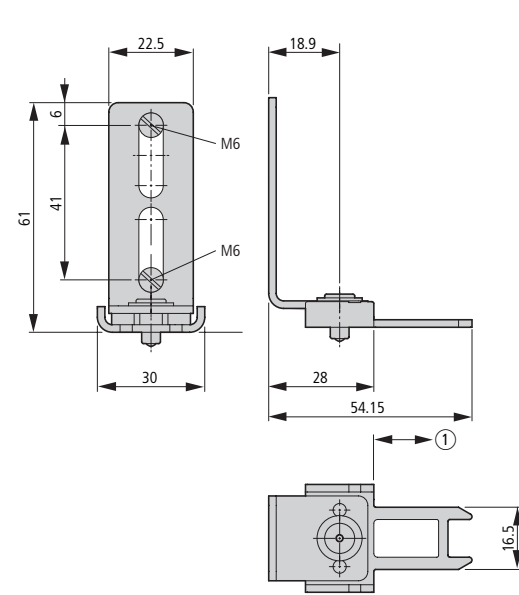

LS-XNW-ZBZ

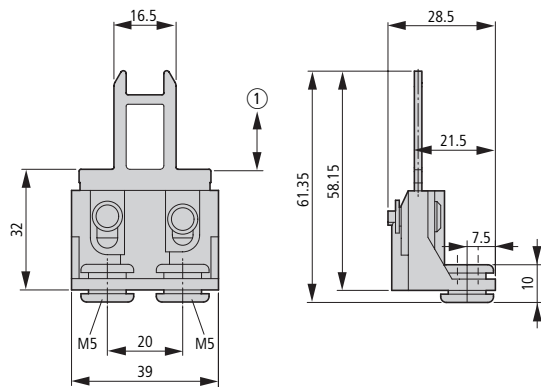

LS-XNG-ZBZ

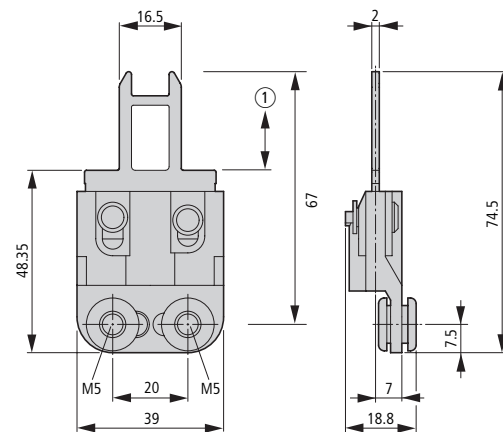

Fixing only allowed with M5 fixing screw and washer according to DIN EN ISO 7093

Fixing only allowed with M5 fixing screw and washer according to DIN EN ISO 7093

LS-XFG-ZBZ

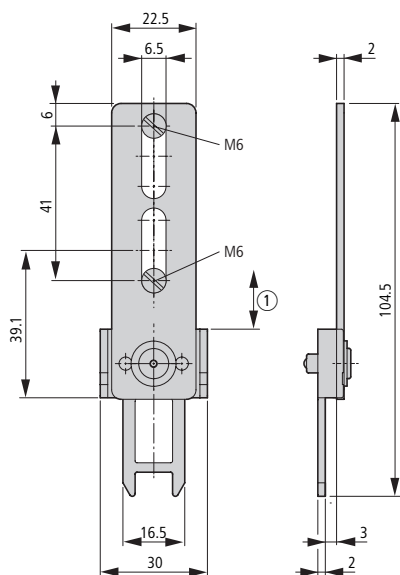

LS-XWA-ZBZ

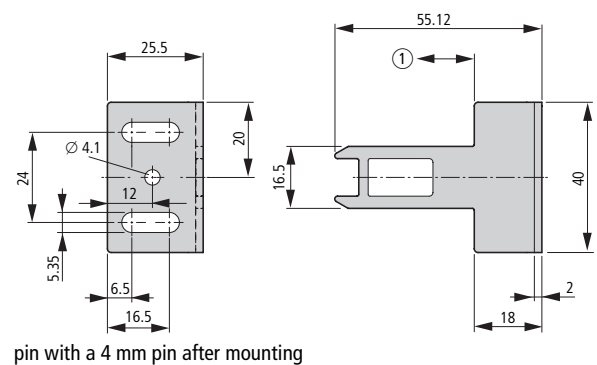

pin with a 4 mm pin after mounting

① Distance to device head = 0.1 ... 3.0 mm

Safety switches



Position switches, safety position switch

<http://catalog.moeller.net>

Moeller HPL0211-2007/2008

LS, LSR **xCommand**

Safety door flap switch

LSR-.../TKG

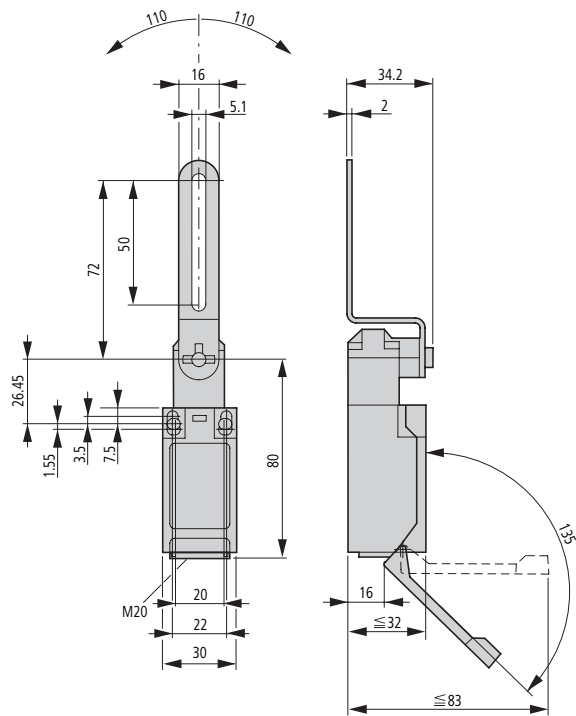

Safety hinge switch

LSR-.../TS

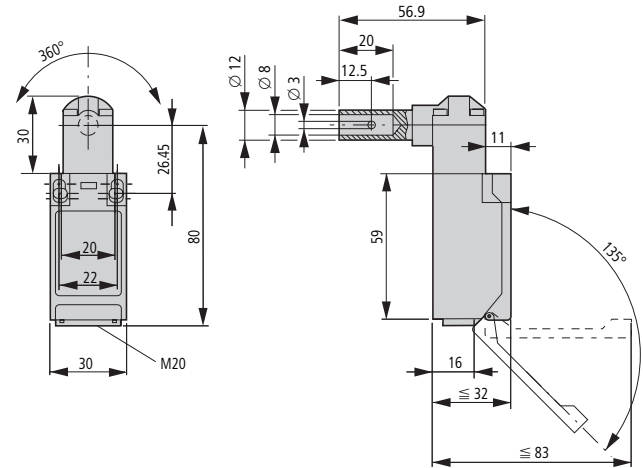

Safety position switches

LS...-ZB

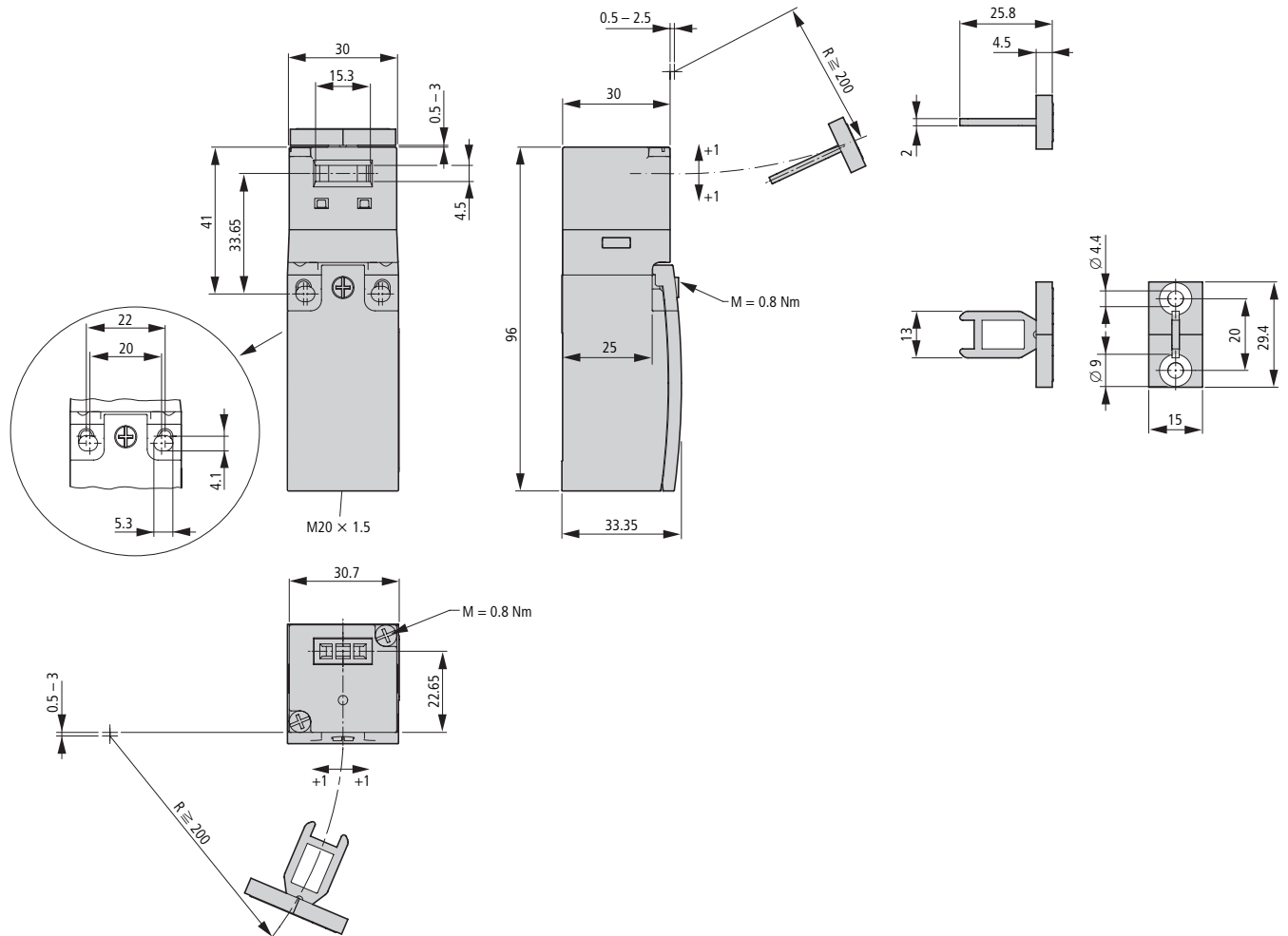

Switch must not be used as a mechanical stop.

Safety switches



Safety position switches

LS4...ZB

Safety switches

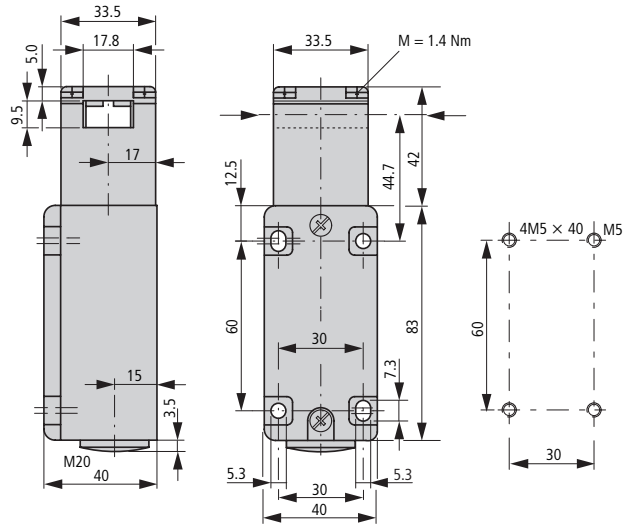

Actuator

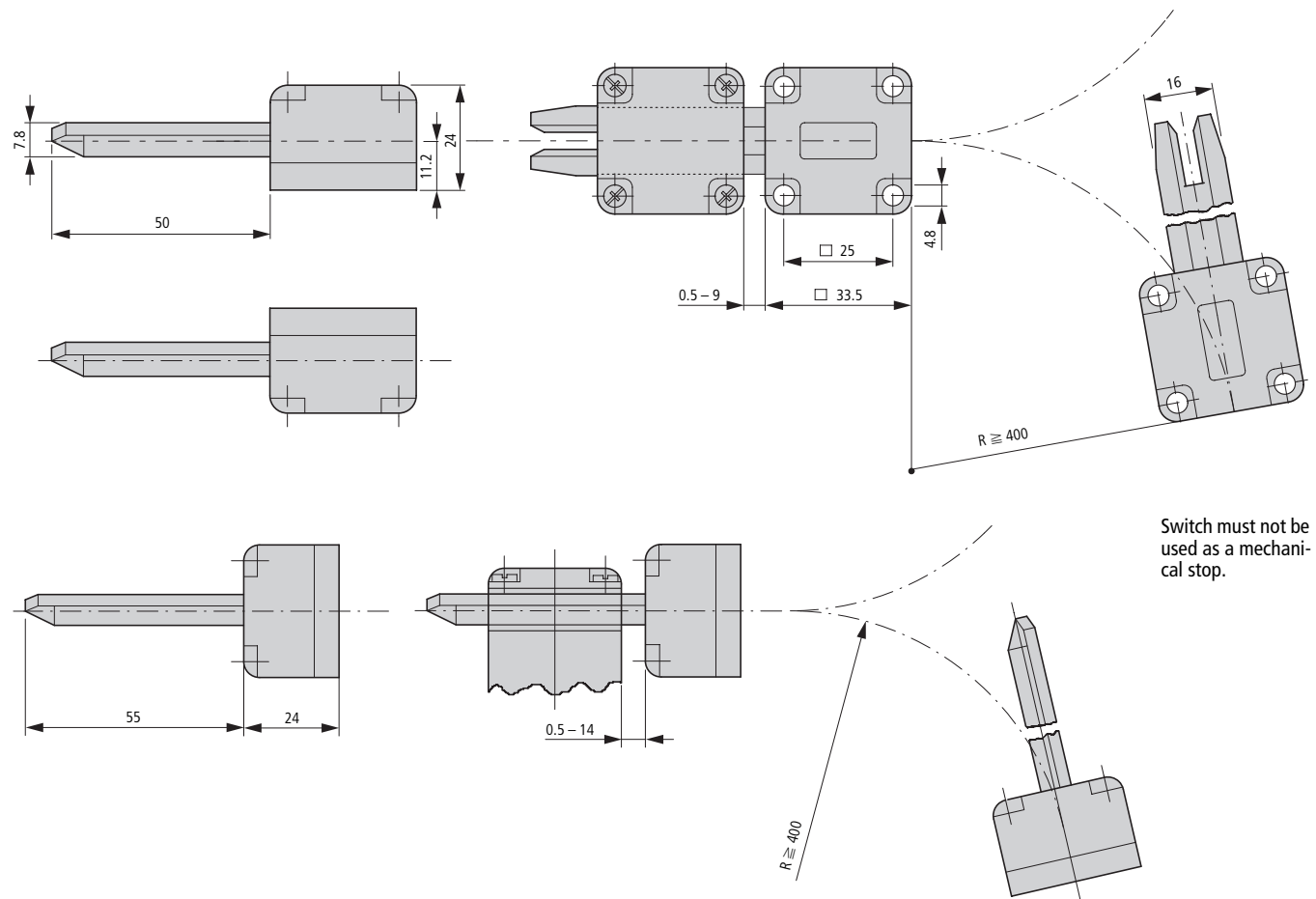

DC voltage version (PNP)
Metal housing

LSI-R85-F1-LD

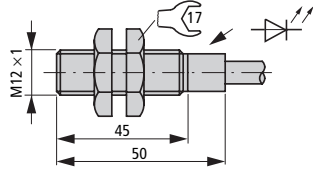

LSI-R85-F1-PD
LSI-R85-NF3-PD

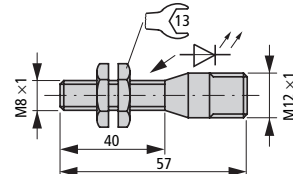

LSI-R12M-F2-LD

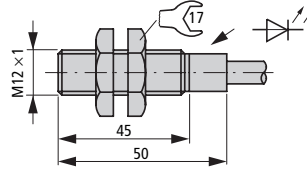

LSI-R12M-F2-PD
LSI-R12M-NF4-PD

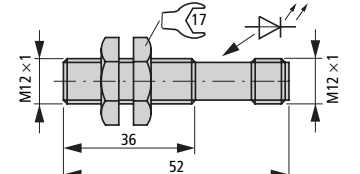

LSI-R12P-F2-LD
LSI-R12P-NF4-LD
LSI-R12P-F2-LA

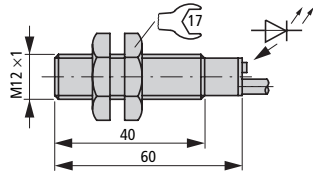

LSI-R18P-NF8-LD
LSI-R18P-F5-LD
LSI-R18P-F5-LA
LSI-R18M-F5-LD

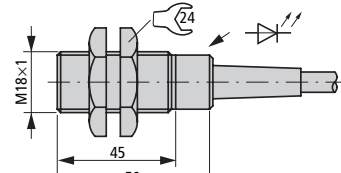

LSI-R18M-NF8-PD
LSI-R18M-F5-PD

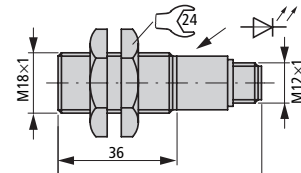

LSI-R30M-F10-LD

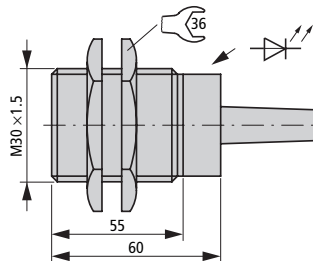

LSI-R30M-NF15-PD
LSI-R30M-F10-PD

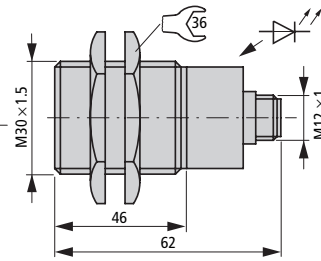

LSI-R30P-F10-LD
LSI-R30P-F10-LA
LSI-R30P-NF15-LD

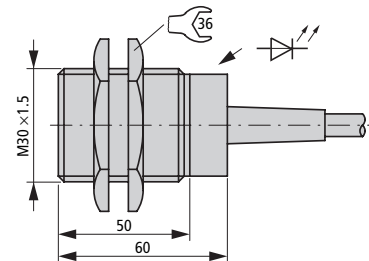

LSI-Q40P-F20-CD
LSI-Q40P-F20-CA
LSI-Q40P-NF40-CD
LSI-Q40P-NF35-CA

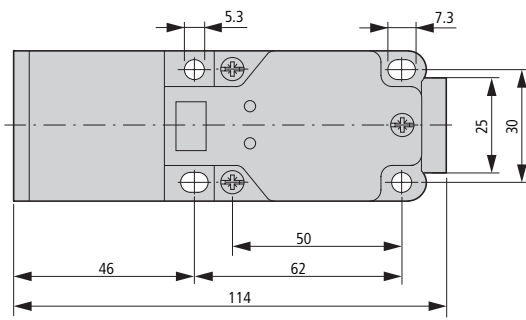
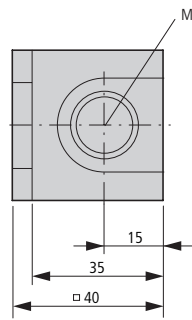

LSI-Q40P-NF35-PD
LSI-Q40P-F20-PD

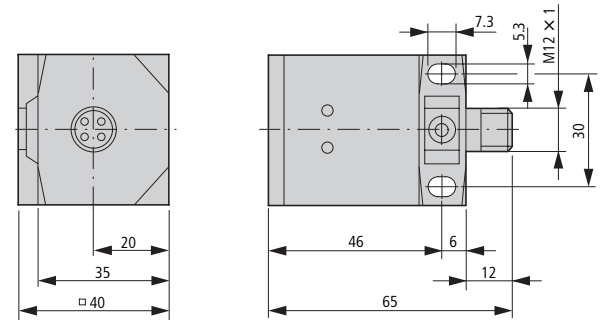

LSI-X3M-CA2-D4Y
LSI-X3M-CAPS1-D4Y
LSI-X3M-CA5-D4Y
LSI-X4M-CAPS1-D4Y
LSI-X4M-CA2-A4N

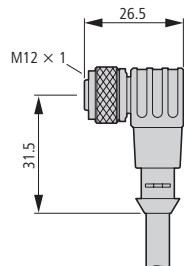

LSI-X4P-CAF-A4N

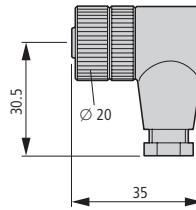

LSI-X4M-PAF-A4N

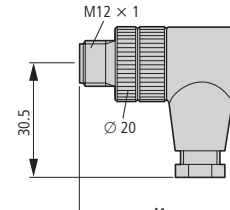

LSI-X3M-CSPS5-A4N
LSI-X3M-CSPS2-A4N
LSI-X3M-CSPS1-A4N
LSI-X3M-CSPS1,5-A4N
LSI-X4M-CSPS1-A4N
LSI-X4M-CSPS5-A4N
LSI-X4M-CSPS2-A4N
LSI-X4M-CS2-A4N

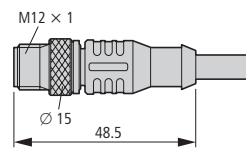

LSI-X4P-CSF-A4N

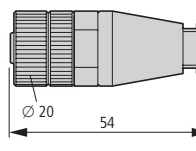

LSI-X4M-PSF-A4N

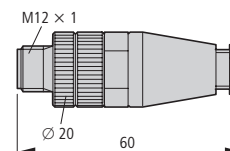

Proximity switches

LSC capacitive proximity switches

LSC-R12M-F3-LD

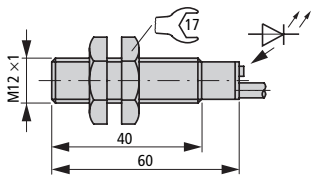

LSC-R18M-F5-LD

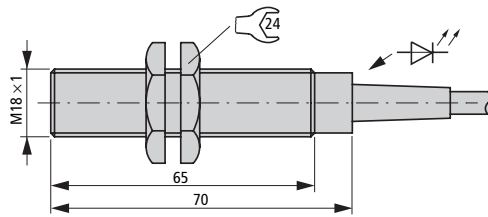

LSC-R30M-F10-LD

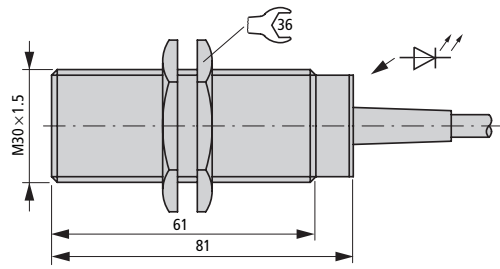

LSC-Q20M-F5-LD

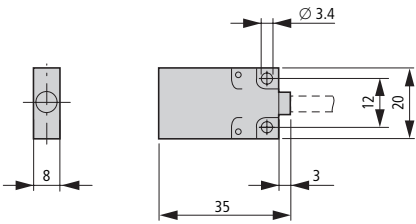

LSC-Q40P-F20-CD

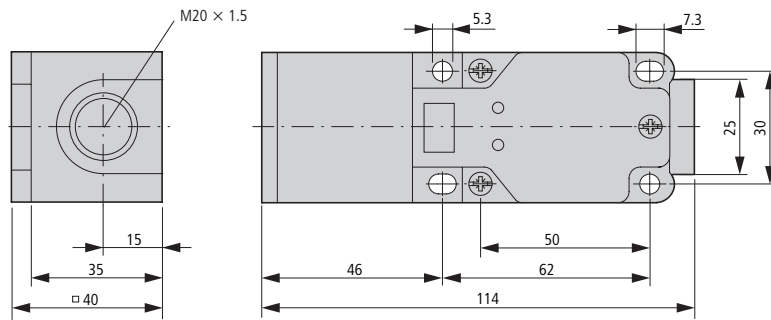

Optical proximity switches

LSO-R18P-S300-PD

LSO-R18P-B2000-PD

LSO-R18S-S300-PD

LSO-R18S-B2000-PD

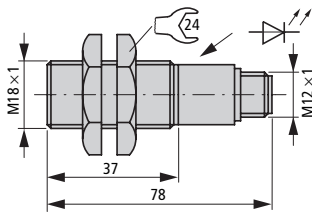

LSO-R18S-B2000-LD

LSO-R18P-S300-LD

LSO-R18P-B2000-LD

LSO-R18S-S300-LD

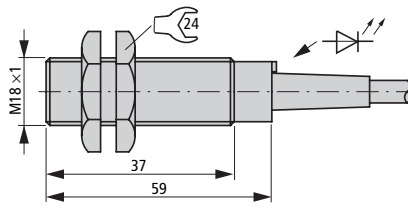

LSO-R30P-B6000-LD

LSO-R30P-S400-LD

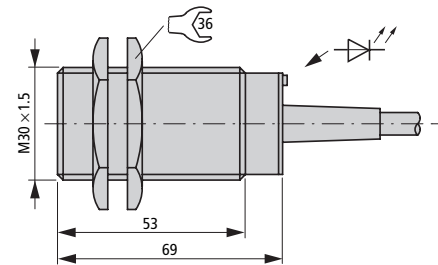

LSO-R30P-B6000-PD

LSO-R30P-S400-PD

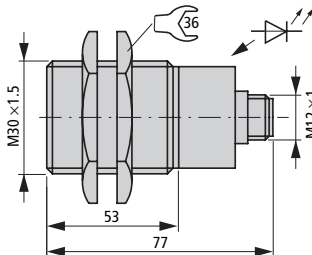

Reflectors for optical proximity switches

LSO-XR40

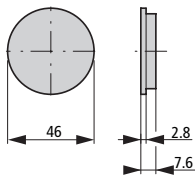

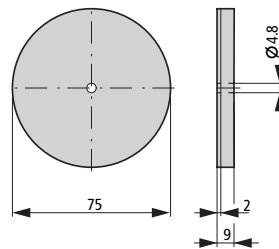

LSO-XR75

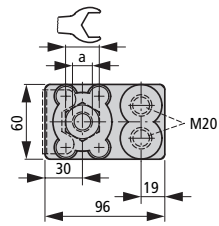

Pressure switches

MCS..., MCS N...



Part no.	Cable entry	a	
MSC...	2 × M20	R 1/4"	27
MSCN...	2 × M20	R 1/2"	36

MCSN...V
With relief valve

