

DIN W48 × H48mm Star-delta timer

Upgrade

■ Features

- Realization of wide range of power supply
: 100–240VAC 50/60Hz / 24–240VDC
- Wide range of setting time and switching time
 - T1 (Setting time) : Selectable 5 to 100sec.
 - T2 (Switching time) : Selectable 0.05, 0.1, 0.2, 0.3, 0.4, 0.5sec.
- Simple setting time, switching time operation
- Easy to check output status by LED display
- Application : Starting large capacity motors



⚠ Please read "Caution for your safety" in operation manual before using.



■ Ordering information

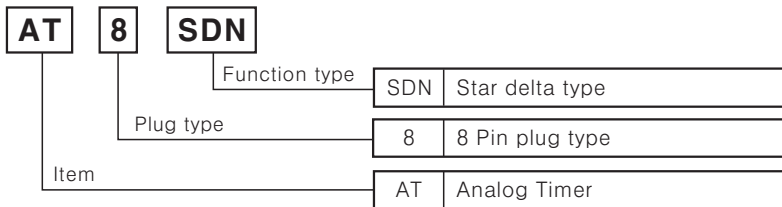

※ Socket required : PG-08, PS-08

■ Specifications

Model	AT8SDN	
Function	Star-delta timer	
Control time setting range	0.5 to 100 sec.	
Power supply	100–240VAC 50/60Hz / 24–240VDC	
Allowable voltage range	90 to 110% of rated voltage	
Power consumption	100–240VAC : 3.2VA, 24–240VDC : 1.5W	
Reset time	Max. 100ms	
Timing operation	Power ON start type	
Control output	Contact type	∧ contact : SPST(1a), Δ contact : SPST(1a)
	Contact capacity	250VAC 5A resistive load
Relay life cycle	Mechanical	Min. 10,000,000 times
	Electrical	Min. 100,000 times (250VAC 5A resistive load)
Repeat error	Max. ±0.2 % ±10ms	
∧ Setting error	Max. ±5% ±50ms	
Voltage error	Max. ±0.5%	
Temperature error	Max. ±2%	
Δ Switching time error	Max. ±25%	
Insulation resistance	100MΩ (at 500VDC megger)	
Dielectric strength	2000VAC 50/60Hz for 1 minute	
Noise strength	±2kV the square wave noise (pulse width : 1μs) by the noise simulator	
Vibration	Mechanical	0.75mm amplitude at frequency of 10 to 55Hz in each of X, Y, Z directions for 1 hours
	Malfunction	0.5mm amplitude at frequency of 10 to 55Hz in each of X, Y, Z directions for 10 minutes
Shock	Mechanical	300m/s ² (Approx. 30G) in X, Y, Z directions 3 times
	Malfunction	100m/s ² (Approx. 10G) in X, Y, Z directions 3 times
Ambient temperature	–10 to 55°C (at non-freezing status)	
Storage temperature	–25 to 65°C (at non-freezing status)	
Ambient humidity	35 to 85%RH	
Approval	CE c UL US	
Unit weight	Approx. 90g	

- (A) Photo electric sensor
- (B) Fiber optic sensor
- (C) Door/Area sensor
- (D) Proximity sensor
- (E) Pressure sensor
- (F) Rotary encoder
- (G) Connector/Socket
- (H) Temp. controller
- (I) SSR/Power controller
- (J) Counter
- (K) Timer**
- (L) Panel meter
- (M) Tacho/Speed/Pulse meter
- (N) Display unit
- (O) Sensor controller
- (P) Switching power supply
- (Q) Stepping motor & Driver & Controller
- (R) Graphic/Logic panel
- (S) Field network device
- (T) Production stoppage models & replacement

AT8SDN Series

Connections

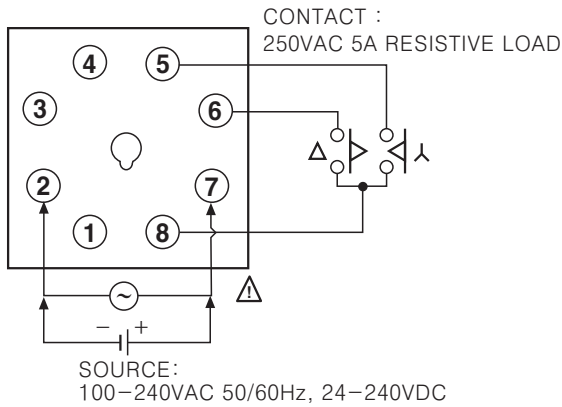

Dimensions

●Bracket

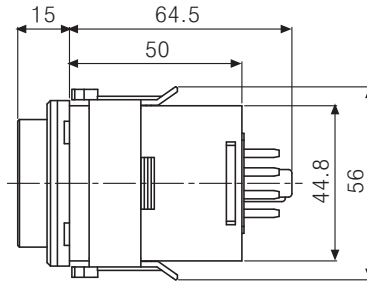
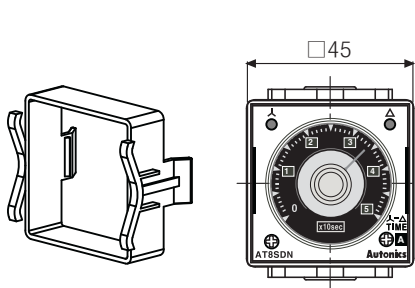

●Panel cut-out

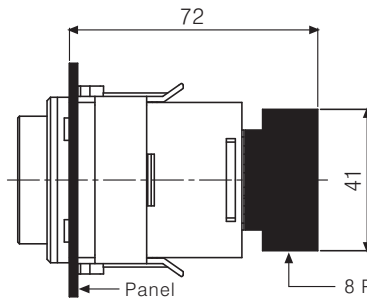
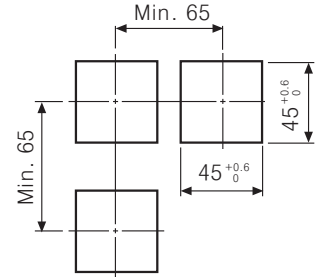

8 Pin socket : PG-08(Sold separately)
*Refer to G-11 page.

(Unit:mm)

Front panel identification

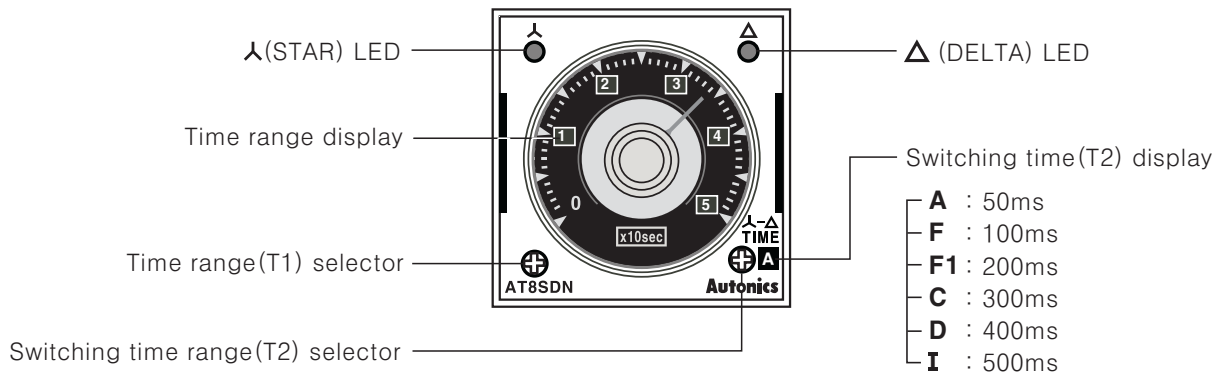

Time specifications

1. T1 (Setting time)

Time range	Time unit	Time setting range
0.5	× 10sec	0.5 to 5sec.
1.0		1 to 10sec.
5		5 to 50sec.
10		10 to 100sec.

2. T2 (Switching time)

Display	A	F	F1	C	D	I
T2 switching time	0.05 sec.	0.1 sec.	0.2 sec.	0.3 sec.	0.4 sec.	0.5 sec.

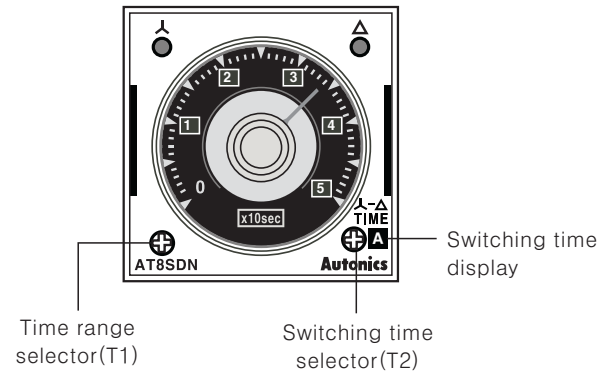

Output operation mode

When power is applied, λ contact will be ON. When reaching to T1 setting time, λ contact will be OFF and Δ contact will be ON after switching time of T2 is passed. If the power is OFF, λ contact will be OFF.

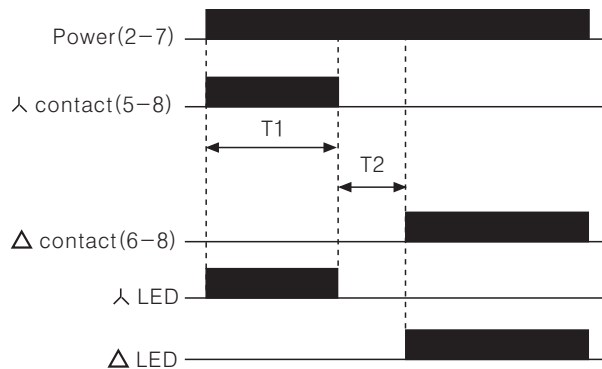

※T1 : Setting time (λ contact operation time)

※T2 : Switching time (λ contact and Δ contact are OFF simultaneously at power ON)

Proper usage

1. Please supply power quickly at once with using switch or relay contact. Otherwise it may cause time error or power reset failure.
2. When supply the power to the timer, connection shown in (Fig. 1) might cause malfunction due to leakage current through R and C. Please connect R and C as shown in (Fig. 2) to prevent malfunction.

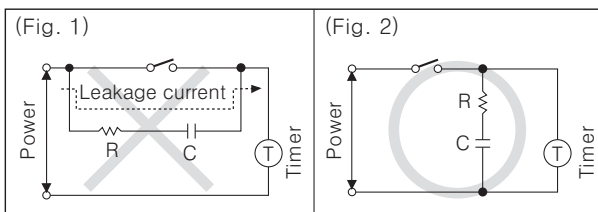

3. It might cause malfunction if changing the setting time, time range or operation mode during operating unit. Please change the the setting time, time range or operation mode after cut the power off.

4. When performing dielectric voltage test or insulation resistance test while the unit is installed on control panel,
 - Please isolate this unit from the circuit of control panel.
 - Please make all terminals of this unit short-circuited.
5. Do not use this unit at below places.
 - Place where there are severe vibration or impact.
 - Place where strong alkalis or acids are used.
 - Place where there are direct rays of the sun
 - Place where strong magnetic field or electric noise are generated.
6. Installation environment
 - It shall be used indoor
 - Altitude Max. 2000m
 - Pollution Degree 2
 - Installation Category II.

(A) Photo electric sensor
(B) Fiber optic sensor
(C) Door/Area sensor
(D) Proximity sensor
(E) Pressure sensor
(F) Rotary encoder
(G) Connector/Socket
(H) Temp. controller
(I) SSR/Power controller
(J) Counter
(K) Timer
(L) Panel meter
(M) Tacho/Speed/Pulse meter
(N) Display unit
(O) Sensor controller
(P) Switching power supply
(Q) Stepping motor & Driver & Controller
(R) Graphic/Logic panel
(S) Field network device
(T) Production stoppage models & replacement