

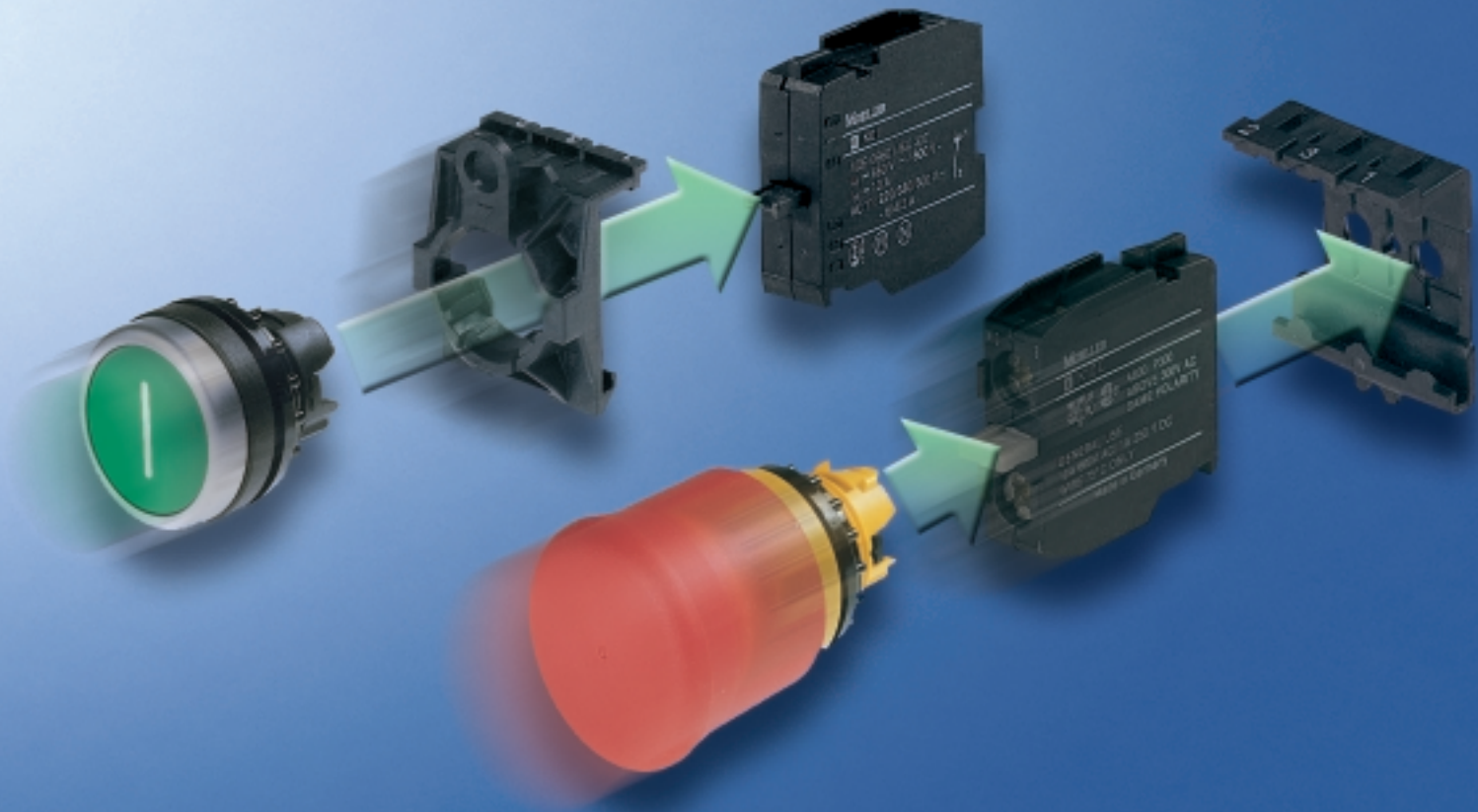









Selection aid







Reliable and Precise Command and Signalling















A22 control circuit devices





Modular units

| Push-button actuators, IP 65 | | Illuminated Push-button actuators, IP 65 | | Mushroom actuators, IP 65 | | |
|-----------------------------------------------------------------------------------|-------------------------------|-----------------------------------------------------------------------------------|-------------------------------------|-------------------------------------------------------------------------------------|-------------------------------------------------------------------------------------|----------------------------------|
|  | |  | |  | | |
| Button plate | Actuator flush, spring return | Button plate | Double actuator with indicator lens | Button plate | Mushroom | Mushroom actuator, spring return |
|  | A22-RD-11 |  | A22-QDDL-11/10 |  |  | A22-RP-GN11 |
|  | A22-RD-10 |  | |  | A22-RP-RT10 | |
| Without | A22-RD-X | | | | | |

| Emergency stop actuators, IP 65 | | Illuminated Push-button actuators, IP 65 | | | |
|-----------------------------------------------------------------------------------|----------------------------------|-------------------------------------------------------------------------------------|-------------------------------|--------------------------|----------------------------------|
|  | |  | | | |
| Funktion | Mushroom actuator, spring return | Button plate | Actuator flush, spring return | Actuator flush, stay put | Actuator extended, spring return |
| Pull to Release | A22-RPV |  | A22-RLT-WS11 | | A22-RLTH-WS11 |
| | |  | A22-RLT-WS | A22-RLTR-WS | A22-RLTH-WS |
| | |  | A22-RLT-GN | A22-RLTR-RN | A22-RLTH-GN |
| | |  | A22-RLT-RT | A22-RLTR-RT | A22-RLTH-RT |
| | |  | A22-RLT-GE | A22-RLTR-GE | A22-RLTH-GE |

| Indicator light lens assemblies, IP 65 | | | Selector switch actuators, IP 65 | | Key-operated actuators, IP 65 |
|-------------------------------------------------------------------------------------|------------|-----------|---------------------------------------------------------------------------------------|-------------------------|---------------------------------------------------------------------------------------|
|  | | |  | |  |
| Lens | Flush | Conical | Function | Thumb-grip, 2 positions | KMS1 lock mechanism, 2 positions |
|  | A22-RLF-WS | A22-RL-WS |  | A22-RWK1V | |
|  | A22-RLF-GN | A22-RL-GN |  | A22-RWK1R | A22-RS |
|  | A22-RLF-RT | A22-RL-RT |  | A22-RWK1 | |
|  | A22-RLF-GE | A22-RL-GE | | 3 positions | 3 positions |
|  | A22-RLF-BL | |  | A22-RWK3R | A22-RS3 |
| | | |  | A22-RWK3 | A22-RS3-KMS1-A4 |
| | | |  | Stay-put | |
| | | |  | Spring-Return | |

| Mushroom actuator IP 65 | | Adapters | | BA9s Filament bulbs | |
|-------------------------------------------------------------------------------------|------------------------------------|-------------------------------------------------------------------------------------|-----------------------|---------------------|-----------|
|  | |  | | | |
| Funktion | KMS1 key release Mushroom actuator | Flushing mounting | Surface/rear mounting | BA9s Filament bulbs | Type |
| | A22-RPSR | A22-BE6 | A22-BE3C | 2W / 24 V | A22-GL24 |
| | | | | 2.4 W / 130 V | A22-GL130 |

Modular units

Contact elements,
IP 20



| Function | Flushing mounting | Surface/rear mounting |
|----------|-------------------|-----------------------|
| | A22-EK10 | A22-EK10C |
| | A22-EK01 | A22-EK01C |
| | A22-EC11 | |
| | A22-EC20 | |
| | A22-EC02 | |

Lamp Sockets,
IP 20



| Lamp voltage | Flushing mounting | Surface/rear mounting |
|--------------|-------------------|-----------------------|
| Max. 2 W | A22-EF | A22-EFC |
| Max. 2.4 W | A22-EFR | A22-EFRC |

Complete units

Push-button actuators,
IP 65



| Button plate | Function | Flush |
|--------------|----------|----------------|
| | | A22-RD-11/K 10 |
| | | A22-RD-11/K 11 |
| | | A22-RD-10/K 01 |
| | | A22-RD-10/K 11 |

Double actuators with indicator light 220-240 V,
IP 65



| Button plate | Function | Flush |
|--------------|----------|-----------------------|
| | | A22-QDDL-11/10/K 11 F |
| | | |

Mushroom actuators,
IP 65



| Button plate | Function | Flush |
|--------------|----------|------------------|
| | | A22-RP-GN11/K 10 |

Key-release mushroom actuator with two keys,
KMS1 lock mechanism, IP 65



| Button plate | Function | Flush |
|--------------|----------|---------------|
| | | A22-RPSR/K 01 |

Illuminated push-button actuators, Flush with
BA 9s filament bulb 230 V, IP 65



| Color | Function | Flush |
|-------|----------|--------------------|
| | | A22-RLT-WS/K 10/FR |
| | | A22-RLT-GN/K 10/FR |
| | | A22-RLT-RT/K 01/FR |

Indicator lights conical with
BA 9s filament bulb 230 V, IP 65



| Color | Function | Flush |
|-------|----------|--------------|
| | | A22-RL-WS/FR |
| | | A22-RL-GN/FR |
| | | A22-RL-RT/FR |
| | | A22-RL-GE/FR |

Complete units

Indicator light, compact without lights, Flush, with BA 9s lamp socket, IP 67, IP 69 K

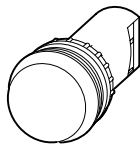

| Color | | |
|-------|--|----------|
| | | A22-LC-W |
| | | A22-LC-G |
| | | A22-LC-R |
| | | A22-LC-Y |

Complete Units for surface mounting, IP 65



| Button plate | Function | Push button actuators, Flush |
|--------------|----------|------------------------------|
| | | A22-RD-11/KC/I |
| | | A22-RD-10/KC/I |

Accessories

Accessories

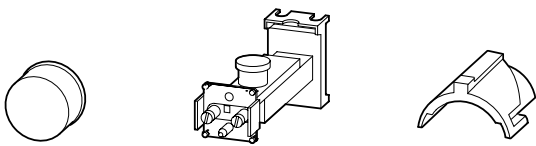

Actuator diaphragms for IP 67, Round style

A22-MT-D

Telescopic clip

A22-TC-RMO

Set of coding adapters for Selector switch actuators consist of two coding adapters

A22-SP-RMQ

| Function | | | |
|---------------|--|---|--|
| Stay-put | | - | |
| Spring-Return | | - | |

Accessories

BA 9s single chip LED For 18-30 V DC / AC voltage (protected against polarity reversal)

| Color/Symbol | Type |
|--------------|-----------|
| | A22-LED-W |
| | A22-LED-G |
| | A22-LED-R |
| | A22-LED-Y |

Push-button plates

| | |
|--|---------|
| | A22-01T |
| | A22-02T |
| | A22-03T |
| | A22-04T |
| | A22-05T |
| | A22-06T |
| | A22-10T |
| | A22-11T |
| | A22-12T |
| | A22-13T |
| | A22-14T |
| | A22-19T |
| | A22-20T |
| | A22-37T |
| | A22-38T |
| | A22-32T |

Complete Legend Plates,

Label mount, black, with aluminium colored insert plate

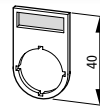

| Text black | |
|-------------|-------------|
| | A22-RAS-32 |
| | A22-RAS-33 |
| | A22-RAS-90 |
| | A22-RAS-93 |
| | A22-RAS-98 |
| STOP | A22-RAS-110 |
| START | A22-RAS-111 |
| MAN./AUTO | A22-RAS-395 |
| MAN. 0 AUTO | A22-RAS-397 |

Insert plates, aluminium colored, can be engraved



| Color | |
|-------|----|
| | XA |

Label mounts

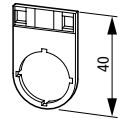

| Color | |
|-------|-------|
| | RAS-X |

Emergency Stop Labels

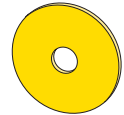

| Text | |
|----------------|----------|
| Blank | 1 AK |
| Emergency-Stop | 1 AK-999 |

Enclosure, IP 65



| Color | Enclosure, IP 65 |
|--------------|------------------|
| Yellow/Black | A22-IGE 1M |

Enclosures IP 65, Gray / Black



| | Enclosures |
|---------------|------------|
| (1 location) | A22-I1M |
| (2 locations) | A22-I2M |
| (3 locations) | A22-I3M |
| (4 locations) | A22-I4M |
| (5 locations) | A22-I5M |

E-Mail:
info@moeller.net
www.moeller.net

© 2003 by Moeller GmbH
Subject to alteration
AH1160-0032GB MDS/?? 10/03
Printed in the Federal Republic
of Germany (10/03)
Article No.: 274160