

## GN DC Series



- Output current ratings of 10, 15 and 30 amps
- Output voltage 3-60, 1-50, 1-100 and 1-200 VDC
- 3-32VDC control
- cUL/TUV Approved, CE & RoHS Compliant

### PRODUCT SELECTION

Control Voltage	10A	10A	15A	30A
3-32 VDC	84134750	84134850	84134860	84134870

### AVAILABLE OPTIONS

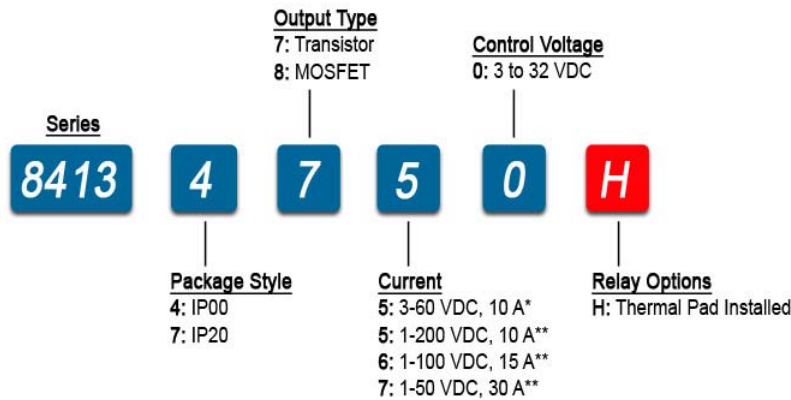

- Required for valid part number
- For options only and not required for valid part number

\* With Output Type 7 only  
\*\* With Output Type 8 only

### OUTPUT SPECIFICATIONS (1)

Description	84134750	84134850	84134860	84134870
Operating Voltage Range [Vdc]	3-60	1-200	1-100	1-50
Maximum Load Current [Adc]	10	10	15	30
Minimum Load Current [mAdc]	10	0.1	0.1	0.1
Maximum Off-State Leakage Current [mAdc]	1.0	0.01	0.01	0.01
Maximum 1 sec Surge Current	90	60	120	180
Maximum On-State Voltage Drop @ Rated Current	1.6	n/a	n/a	n/a
Maximum On-State Resistance [Ohms]	n/a	0.09	0.09	0.09
Thermal Resistance Junction to Baseplate [°C/W]	4.3	4.4	4.6	2.3

### INPUT SPECIFICATIONS (1)

Description	84134750	841348xx
Input Voltage Range (5)	3-32 VDC	3-32 VDC
Minimum Turn-On Voltage	3.0 VDC	3.0 VDC
Drop out Voltage	1.0 VDC	1.0 VDC
Maximum Input Current	14.5mA	20mA
Minimum input current (for on-state)	9mA	12mA
Turn-on time [ms]	0.1	2
Turn-off time [µs]	200	50

**GENERAL SPECIFICATIONS**

Description	Parameters
Ambient Operating Temperature Range (5)	-40 to 80 °C
Ambient Storage Temperature Range	-40 to 100 °C
Input to output isolation	4000 Vrms
Input/output to ground isolation	2500 Vrms
Input to output capacitance	8 pF
Housing Material	UL 94V0 (self extinguishing)
Status Indicating Display	Green
Weight (typical)	0.16 lbs (73.6 g)
Input Terminal Screw Torque (6-32 screw) [in lbs/Nm]	8-10 / 0.9-1.1
Output Terminal Screw Torque (8-32 screw) [in lbs/Nm]	15-20 / 1.7-2.2

**GENERAL NOTES**

**MECHANICAL SPECIFICATIONS**

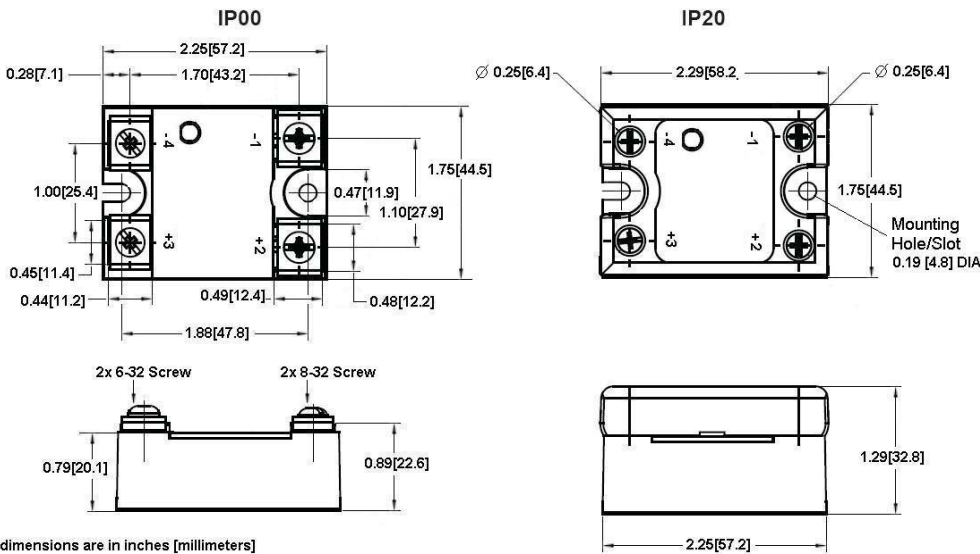

All dimensions are in inches [millimeters]

**WIRING DIAGRAM**

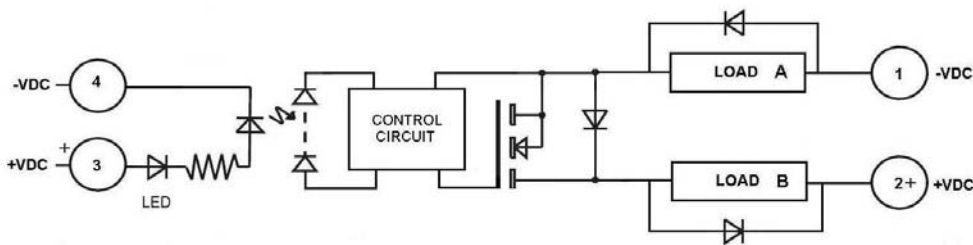

Load can be wired in position A or B

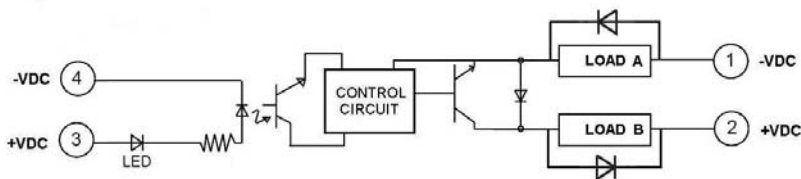

**THERMAL DERATE INFORMATION**

DERATING CURVE: 8413x750

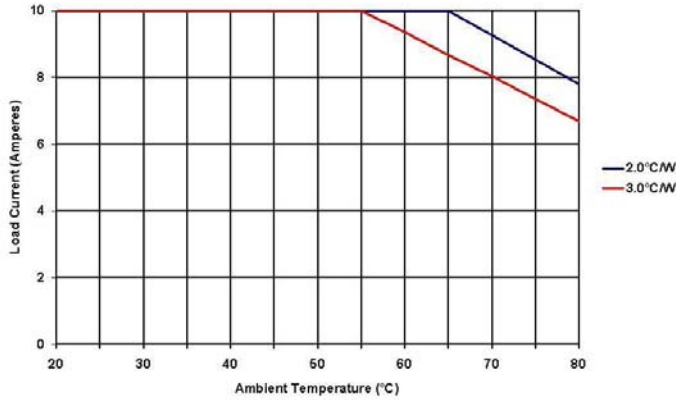

DERATING CURVE: 8413x850

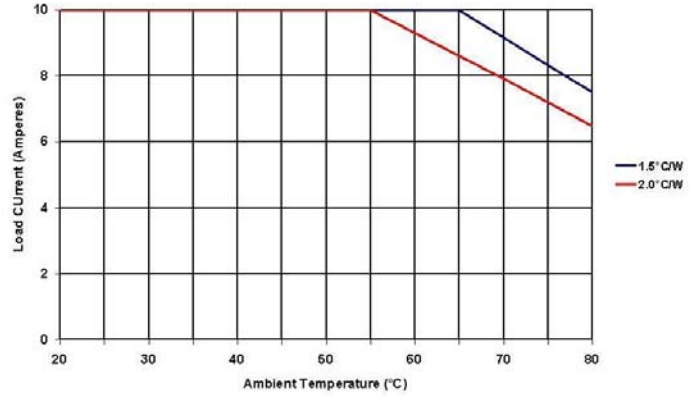

DERATING CURVE: 8413x860

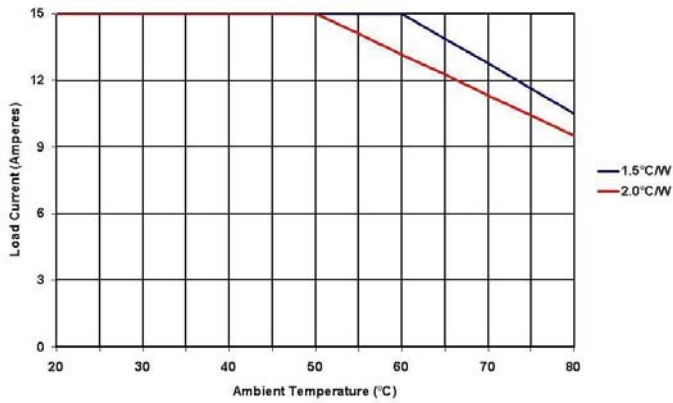

DERATING CURVE: 8413x870

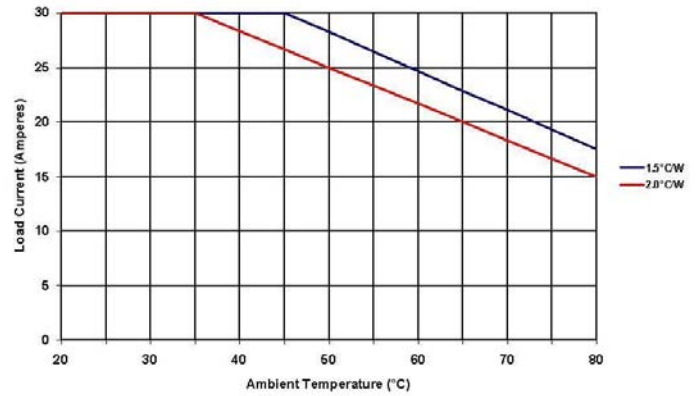

Heat sink part numbers corresponding to °C/W ratings above:  
 3.0°C/W = HS301  
 2.0°C/W = HS202 or HS201  
 1.5°C/W = HS151

**AGENCY APPROVALS**



Rev. 022811

 <b>DANGER / PELIGRO / DANGER /GEFAHR / PERICOLO / PERIGO</b>					
<p><b>HAZARD OF ELECTRIC SHOCK, EXPLOSION, OR ARC FLASH.</b></p> <ul style="list-style-type: none"> <li>Disconnect all power before installing or working with this equipment.</li> <li>Verify all connections and replace all covers before turning on power.</li> </ul> <p>Failure to follow these instructions will result in death or serious injury.</p>	<p><b>RIESGO DE DESCARGA ELECTRICA O EXPLOSION.</b></p> <ul style="list-style-type: none"> <li>Desconectar todos los suministros de energia a este equipo antes de trabajar con este equipo.</li> <li>Verificar todas las conexiones y colocar todas las tapas antes de energizar el equipo.</li> </ul> <p>El incumplimiento de estas instrucciones puede provocar la muerte o lesiones serias.</p>	<p><b>RISQUE DE DESCARGE ELECTRIQUE OU EXPLOSION</b></p> <ul style="list-style-type: none"> <li>Eteindre toutes les sources d'énergie de cet appareil avant de travailler dessus de cet appareil</li> <li>Vérifier tous connections, et remettre tous couverts en olace avant de mettre sous</li> </ul> <p>De non-suivi de ces instructions provoquera la mort ou des lésions sérieuses sérieuses.</p>	<p><b>GEFAHR EINES ELEKTRISCHE N SCHLAGES ODER EINER EXPLOSION.</b></p> <ul style="list-style-type: none"> <li>Stellen Sie jeglichen Strom ab, der dieses Gerät versorgt, bevor Sie an dem Gerät Arbeiten durchführen</li> <li>Vor der Inbetriebnahme alle Anschlüsse überprüfen und alle Gehäuseteile montieren.</li> </ul> <p>Unterlassung dieser Anweisungen können zum Tode oder zu schweren Verletzungen führen.</p>	<p><b>RISCHIO DI SCOSSA ELETTRICA O DELL'ESPLOSIONE.</b></p> <ul style="list-style-type: none"> <li>Spenga tutta l'alimentazion e che fornisce questa apparecchiatura prima del lavorare a questa apparecchiatura</li> <li>Verificare tutti i collegamenti e sostituire tutte le coperture prima della rotazione sull'alimentazione</li> </ul> <p>L'omissione di seguire queste istruzioni provocherà la morte o di lesioni serie</p>	<p><b>RISCO DE DESCARGA ELÉTRICA OU EXPLOÇÃO</b></p> <ul style="list-style-type: none"> <li>Desconectar o equipamento de toda a energia antes de instalar ou trabalhar com este equipamento</li> <li>Verificar todas as conexões e recolocar todas as tampas antes de religar o equipamento</li> </ul> <p>O não cumprimento destas instruções pode levar a morte ou lesões sérias.</p>

 <b>WARNING / AVERTISSEMENT / WARNUNG /ADVERTENCIA / AVVERTENZA / AVISO</b>		
<p><b>RISK OF MATERIAL DAMAGE AND HOT ENCLOSURE</b></p> <ul style="list-style-type: none"> <li>The product's side panels may be hot, allow time for product to cool before touching.</li> <li>Follow proper mounting instructions including torque values.</li> <li>Do not allow liquids or foreign objects to enter this product.</li> </ul> <p>Failure to follow this instruction can result in serious injury, or equipment damage.</p>	<p><b>RISQUE DE DOMMAGE MATERIEL ET DE SURCHAUFFE DU BOITIER</b></p> <ul style="list-style-type: none"> <li>Les panneaux latéraux du produit peuvent être chauds. Laisser le produit refroidir avant de le toucher.</li> <li>Respecter les consignes de montage, et notamment les couples de serrage.</li> <li>Ne pas laisser pénétrer de liquide ni de corps étrangers à l'intérieur du produit.</li> </ul> <p>Le non-respect de cette directive peut entraîner, des lésions corporelles graves ou des dommages matériels.</p>	<p><b>GEFAHR VON MATERIALSCHÄDEN UND GEHÄUSEERHITZUNG</b></p> <ul style="list-style-type: none"> <li>Die Seitenwände können heiß sein. Lassen Sie das Produkt abkühlen, bevor Sie es berühren.</li> <li>Beachten Sie die Montageanweisungen, • Führen Sie keine Flüssigkeiten oder Fremdkörper in das Produkt ein.</li> </ul> <p>Die Nichtbeachtung dieser Anweisung kann Körperverletzung oder Materialschäden zur Folge haben.</p>
<p><b>RIESGO DE DAÑOS MATERIALES Y DE SOBRECALENTAMIENTO DE LA UNIDAD</b></p> <ul style="list-style-type: none"> <li>Los paneles laterales del producto pueden estar calientes. Esperar que el producto se enfríe antes de tocarlo.</li> <li>Respetar las instrucciones de montaje, y en particular los pares de apretado.</li> <li>No dejar que penetren líquidos o cuerpos extraños en el producto.</li> </ul> <p>Si no se respetan estas precauciones pueden producirse graves lesiones, daños materiales.</p>	<p><b>RISCHIO DI DANNI MATERIALI E D'INVOLUCRO CALDO</b></p> <ul style="list-style-type: none"> <li>I pannelli laterali dell'apparecchio possono scottare; lasciar quindi raffreddare il prodotto prima di toccarlo.</li> <li>Seguire le istruzioni di montaggio corrette.</li> <li>Non far entrare liquidi o oggetti estranei in questo apparecchio.</li> </ul> <p>La mancata osservanza di questa precauzione può causare gravi rischi per l'incolumità personale o danni alle apparecchiature.</p>	<p><b>RISCO DE DANO MATERIAL E DE AQUECIMENTO</b></p> <ul style="list-style-type: none"> <li>Os painéis laterais do produto podem estar quentes; dê tempo ao produto para arrefecer antes de lhe tocar.</li> <li>Siga devidamente as instruções de montagem.</li> <li>Não permita a entrada de líquidos e de objectos estranhos no produto.</li> </ul> <p>A não observância destas precauções pode provocar a morte, ferimentos graves ou danos materiais.</p>



### ANNEX - ENVIROMENTAL INFORMATION

The environmental information disclosed in this annex including the EIP Pollution logo are in compliance with People's Republic of China Electronic Industry Standard SJ/T11364 – 2006, Marking for Control of Pollution Caused by Electronic Information Products.

Part Name	Toxic or hazardous Substance and Elements					
	Lead (Pb)	Mercury (Hg)	Cadmium (Cd)	Hexavalent Chromium (Cr (VI))	Polybrominated biphenyls (PBB)	Polybrominated diphenyl ethers (PBDE)
Semiconductor die	X	0	0	0	0	0
Solder	X	0	0	0	0	0

此附件所标示的包括电子信息产品污染图标的环保信息符合中华人民共和国电子行业标准 **SJ/T11364 - 2006**, 电子信息产品污染控制标识要求



部件名称	有毒有害物质或元素					
	铅 (Pb)	汞 (Hg)	镉 (Cd)	六价铬 (Cr (VI))	多溴联苯 (PBB)	多溴二苯醚 (PBDE)
半导体芯片	X	0	0	0	0	0
焊接点	X	0	0	0	0	0