

D2n Relay V23105

- Standard DIL relay
- Dimensions 20x10x11mm (.795x.394x.433")
- Switching and continuous current 3A
- 2 form C contacts (2 CO, 2 changeover contacts)
- Immersion cleanable
- Four different coil sensitivities, 150mW, 200mW, 400mW, >500mW
- Surge voltage resistance meets FCC Part 68 requirement: 1.5kV (10/700µs) between coil and contacts

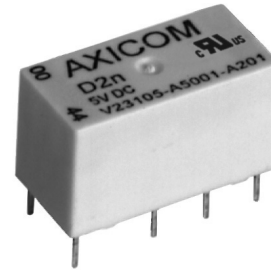

Typical applications

Communications equipment, office equipment, measurement and control equipment, entertainment electronics, medical equipment, consumer electronics

Approvals

UL 508 File No. E 111441
Technical data of approved types on request

Contact Data

Contact arrangement	2 form C (CO)
Max. switching voltage	220VDC, 250VAC
Rated current	3A
Limiting continuous current, 85°C	3A
Contact material	AgNi, gold-covered
Min. recommended contact load	10mA at 20mV
Minimum switching voltage	100µV
Initial contact resistance	<100mΩ at 10mA, 20mV
Frequency of operation without load	max. 50 operations/s
Operate / release time max.	6ms/4ms
Bounce time max.	5 ms
Electrical endurance	
at 230VAC/0.5A	typ. 3x10 ⁵ operations
at 6VDC/0.1A	typ. 2x10 ⁶ operations
at 30VDC/1A	typ. 5x10 ⁵ operations
at 30VDC/2A	typ. 1x10 ⁵ operations
Contact ratings, UL	30VDC/1.0A
	100VDC/0.3A
	125VAC/0.5A
	125VAC/1.0A
150mW and 200mW coil	
400mW and 500mW coil	
Mechanical endurance	typ. 15x10 ⁶ operations

Coil Data

Magnetic system	neutral
Coil voltage range	3 to 48VDC
Max. coil temperature	85 °C
Thermal resistance	< 85K/W

Coil versions, monostable

Coil code	Rated voltage VDC	Operate voltage VDC	Limiting Voltage VDC	Release voltage VDC	Coil resistance Ω±10%	Rated coil power mW
150mW coil power						
001	5	4.0	11.7	0.25	167	150
002	6	4.8	14.0	0.30	240	150
006	9	7.2	21.0	0.45	540	150
003	12	9.6	28.0	0.60	960	150
005	24	19.2	56.0	1.20	3840	150
200mW coil power						
308	3	2.1	6.1	0.15	45	200
301	5	3.5	10.1	0.25	125	200
302	6	4.2	12.2	0.30	180	200
306	9	6.3	18.2	0.45	405	200
303	12	8.4	24.3	0.60	720	200
305	24	16.8	48.6	1.20	2880	200
307	48	33.6	97.2	2.40	11520	200
400mW coil power						
401	5	3.5	7.2	0.25	62	400
402	6	4.2	8.6	0.30	90	400
406	9	6.3	12.9	0.42	203	400
403	12	8.4	17.2	0.60	360	400
405	24	16.8	34.3	1.20	1440	400
407	48	33.6	68.6	2.40	5760	400
>500mW coil power						
501	5	3.5	6.1	0.25	36	695
502	6	4.2	7.3	0.30	70	515
506	9	6.3	10.9	0.45	140	580
503	12	8.4	14.5	0.60	280	515
505	24	16.8	29.1	1.20	1050	550
507	48	33.6	58.1	2.40	4000	575

All figures are given for coil without pre-energization, at ambient temperature +23°C. Other coil voltages on request.

Max. DC load breaking capacity

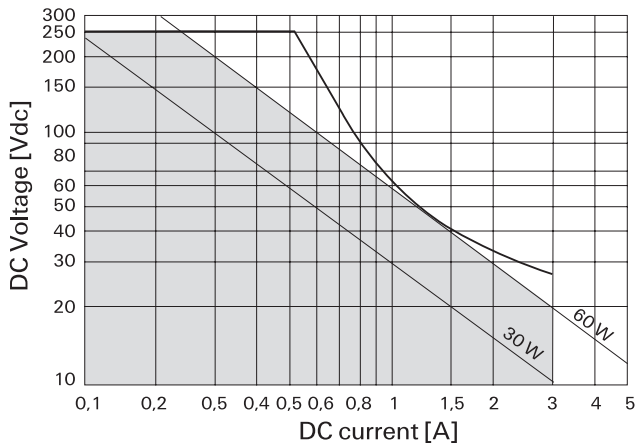

D2n Relay V23105 (Continued)

Coil Data (continued)

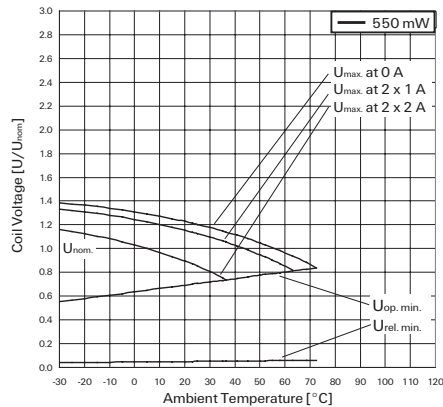
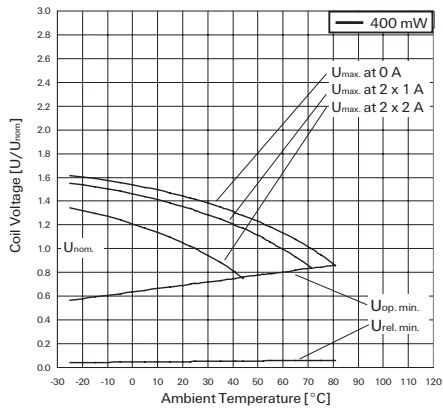
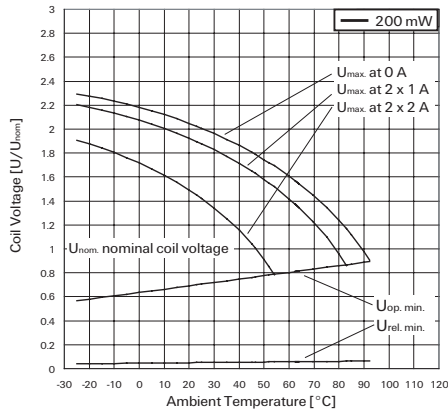
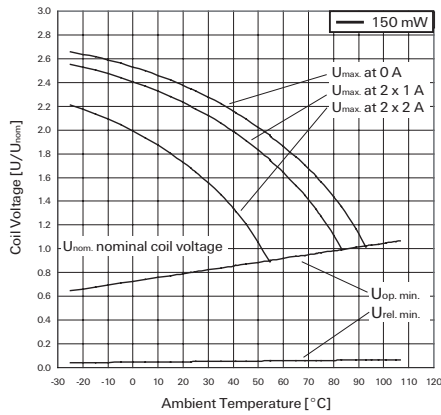

Coil Data (continued)

Coil operative range graphs

- U_{nom} Nominal coil voltage
- U_{max} Upper limit of the operative range of the coil voltage (limiting voltage) when coils are continuously energized
- $U_{op. min.}$ Lower limit of the operative range of the coil voltage (reliable operate voltage)
- $U_{rel. min.}$ Lower limit of the operative range of the coil voltage (reliable release voltage)

Insulation Data

Initial dielectric strength	
between open contacts	750V _{rms}
between contact and coil	1050V _{rms}
between adjacent contacts	750V _{rms}
Initial surge withstand voltage	
between open contacts	1500V
between contact and coil	1500V
between adjacent contacts	1500V
Initial insulation resistance at 500 VDC	
	> 10 ⁹ Ω
Capacitance	
between open contacts	max. 2pF
between contact and coil	max. 4pF
between adjacent contacts	max. 2 pF

RF Data

Isolation at 100MHz/900MHz	-39.0dB/-20.7dB
Insertion loss at 100MHz/900MHz	-0.02dB/-0.27dB
Voltage standing wave ratio (VSWR) at 100MHz/900MHz	1.04/1.40

Other Data

Material compliance: EU RoHS/ELV, China RoHS, REACH, Halogen content refer to the Product Compliance Support Center at www.te.com/customer-support/rohssupportcenter

Ambient temperature	-40 to +85°C
Category of environmental protection	IEC 61810
Degree of protection, IEC 60529	IP 67
Vibration resistance (functional)	10g, 10 to 55Hz
Shock resistance (functional)	IEC 60068-2-27 (half sine)
Shock resistance (destructive)	10g
Terminal type	PCB-THT
Weight	max. 6g
Resistance to soldering heat THT	IEC 60068-2-20
Ultrasonic cleaning	not recommended
Packaging unit	1000 pcs.

Terminal assignment

TOP view on component side of PCB

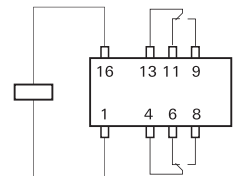

PCB layout

TOP view on component side of PCB

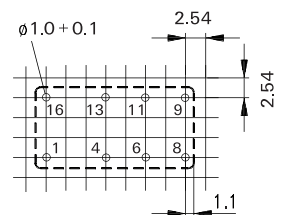

D2n Relay V23105 (Continued)

Dimensions

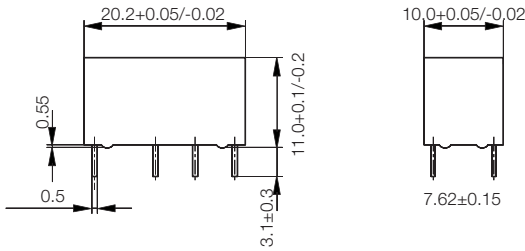

Packing

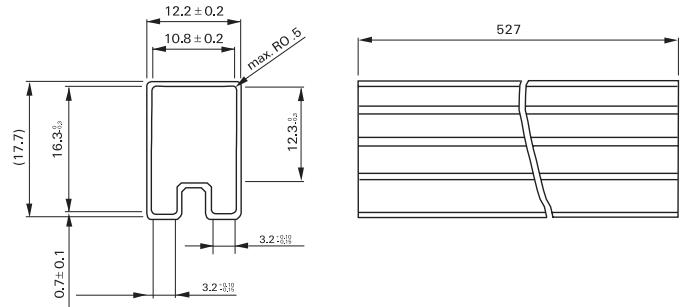

Product code structure

Typical product code **V23105-A5 001 A201**

Type	V23105-A5	D2n Series Signal Relay
Coil	Coil code: please refer to coil versions table	
	Coil power	
	0xx 150 mW	4xx 400 mW
	3xx 300 mW	5xx 550 mW
Contacts	A201 2 form C, 2 CO, AgNi+Au contacts	

Product Code	Version	Coil power	Coil voltage	Part number		
V23105A5001A201	AgNi+Au contacts	150mW	5VDC	8-1393792-5		
V23105A5002A201			6VDC	8-1393792-7		
V23105A5006A201			9VDC	9-1393792-1		
V23105A5003A201			12VDC	8-1393792-8		
V23105A5005A201	200mW	24VDC	24VDC	9-1393792-0		
V23105A5308A201			3VDC	1393793-5		
V23105A5301A201			5VDC	9-1393792-3		
V23105A5302A201			6VDC	9-1393792-5		
V23105A5306A201			9VDC	1393793-2		
V23105A5303A201			12VDC	9-1393792-7		
V23105A5305A201			24VDC	9-1393792-9		
V23105A5307A201			48VDC	1393793-3		
V23105A5401A201			400mW	5VDC	5VDC	1393793-6
V23105A5402A201					6VDC	1393793-7
V23105A5406A201					9VDC	1-1393793-0
V23105A5403A201					12VDC	1393793-8
V23105A5405A201	24VDC	1393793-9				
V23105A5407A201	48VDC	1-1393793-1				
V23105A5501A201	>500mW	5VDC	5VDC	1-1393793-6		
V23105A5502A201			6VDC	1-1393793-8		
V23105A5506A201			9VDC	2-1393793-3		
V23105A5503A201			12VDC	1-1393793-9		
V23105A5505A201			24VDC	2-1393793-1		
V23105A5507A201			48VDC	2-1393793-4		
V23105A5475A201	BT 47 type spec T4563C (current tested)	5VDC	5VDC	1-1393793-2		
V23105A5479A201			10VDC	3-1393794-0		
V23105A5476A201			12VDC	1-1393793-3		
V23105A5477A201			24VDC	1-1393793-4		
V23105A5478A201			48VDC	1-1393793-5		