

# 771

Milliamp Process Clamp Meter

## Calibration Manual



November 2007

© 2007 Fluke Corporation, All rights reserved. Printed in USA. Product specifications are subject to change without notice.  
All product names are trademarks of their respective companies.

### **LIMITED WARRANTY AND LIMITATION OF LIABILITY**

This Fluke product will be free from defects in material and workmanship for 3 years (one year for cable and clamp) from the date of purchase. This warranty does not cover fuses, disposable batteries or damage from accident, neglect, misuse or abnormal conditions of operation or handling. Resellers are not authorized to extend any other warranty on Fluke's behalf. To obtain service during the warranty period, send your defective Meter to the nearest Fluke Authorized Service Center with a description of the problem.

THIS WARRANTY IS YOUR ONLY REMEDY. NO OTHER WARRANTIES, SUCH AS FITNESS FOR A PARTICULAR PURPOSE, ARE EXPRESSED OR IMPLIED. FLUKE IS NOT LIABLE FOR ANY SPECIAL, INDIRECT, INCIDENTAL OR CONSEQUENTIAL DAMAGES OR LOSSES, ARISING FROM ANY CAUSE OR THEORY. Since some states or countries do not allow the exclusion or limitation of an implied warranty or of incidental or consequential damages, this limitation of liability may not apply to you.

Fluke Corporation  
P.O. Box 9090  
Everett, WA 98206-9090  
U.S.A.

Fluke Europe B.V.  
P.O. Box 1186  
5602 BD Eindhoven  
The Netherlands

11/99

To register your product online, visit <http://register.fluke.com>

# Table of Contents

Title	Page
Introduction.....	1
Contacting Fluke.....	2
Safety Information .....	2
Symbols .....	3
Specifications.....	4
Getting Acquainted with the Meter.....	5
Maintenance.....	6
Cleaning the Meter .....	6
Battery Replacement .....	6
Performance Tests.....	8
Required Equipment.....	8
Testing the Batteries .....	8
Testing the Display.....	9
Display Hold Test.....	9
Backlight Test.....	9
Spotlight LED Test.....	9
Zero Test.....	9
Accuracy Tests .....	9
Calibration Adjustment.....	11
Adjustment Subroutines .....	11
Front Panel Operation for Adjustment .....	11
Calibration Error Messages .....	12
Calibration Adjustment Procedure .....	12
Temperature Adjustment Procedure.....	13
Low Range Adjustment Procedure.....	13
High Range Adjustment Procedure .....	13
Phase Adjustment Procedure .....	14
User Replaceable Parts .....	15



# ***List of Tables***

<b>Table</b>	<b>Title</b>	<b>Page</b>
1.	Symbols.....	3
2.	Required Equipment.....	8
3.	Accuracy Tests.....	10
4.	Error Messages.....	12
5.	Replaceable Parts.....	15



# ***List of Figures***

<b>Figure</b>	<b>Title</b>	<b>Page</b>
1.	The 771 Milliamp Process Clamp Meter .....	5
2.	Changing the Batteries .....	7
3.	Display Test .....	9
4.	Accessing the Calibration Button.....	12
5.	Phase Adjustment.....	14
6.	Replaceable Parts .....	16





# 771 Milliamp Process Clamp Meter

## Introduction

### Warning

**To avoid electric shock or personal injury, do not perform the calibration verification tests or calibration procedures described in this manual unless you are qualified to do so. The information provided in this manual is for the use of qualified personnel only.**

This manual provides the complete verification and adjustment procedure for the 771 Milliamp Process Clamp Meter (referred to in this manual as the Meter). The Meter allows closed-case calibration using reference sources. It measures the reference signals, calculates the correction factors, and stores them in memory. The instrument should be calibrated after repair, or if it fails a performance test.

The *771 Calibration Manual* provides the following information:

- Precautions and safety information
- Specifications
- Basic maintenance
- Calibration verification procedure
- Replaceable parts and accessories

For complete operating instructions, refer to the *771 Instruction Sheet*.

## Contacting Fluke

To contact Fluke, call:

1-888-993-5853 in USA  
1-800-363-5853 in Canada  
+31-402-675-200 in Europe  
+81-3-3434-0181 in Japan  
+65-738-5655 in Singapore  
+1-425-446-5500 from anywhere in the world

Or, visit Fluke's Web site at [www.fluke.com](http://www.fluke.com)

To register your product, visit <http://register.fluke.com>

## Safety Information

In this manual, a **Warning** identifies conditions and actions that pose hazard(s) to the user. A **Caution** identifies conditions and actions that may damage the test instrument.

The design and manufacture of the device conforms to the latest state of technology and the safety standards specified in IEC 61010-1/ 2<sup>nd</sup> edition. If used improperly, there is a risk of damage to persons and property.

### Warning

**To avoid possible electric shock or personal injury, follow these guidelines:**

- **Read this manual before use and follow all safety instructions.**
- **Use the Meter only as specified in this manual; otherwise, the Meter's safety features may be impaired.**
- **Before each use inspect Meter and cable for damage. Look for cracks and missing portions of the clamp and cable. Do not use if clamp is damaged.**
- **Use caution when working with voltages above 33 V rms 47 V peak or 70 V dc these voltages pose a shock hazard.**
- **Do not use to measure ac current.**
- **Do not use to measure dc mA in circuits carrying more than 300 V CAT II.**
- **Avoid working alone so assistance can be rendered in an emergency.**
- **Use extreme caution when working around bare conductors or bus bars. Contact with the conductor could result in electric shock.**
- **To avoid false readings that can lead to electrical shock and injury, replace the batteries as soon as the low battery indicator (🔋) appears.**
- **Adhere to local and national safety codes. Individual protective equipment must be used to prevent shock and arc blast injury where hazardous live conductors are exposed.**

- **When measuring, keep fingers behind the Tactile Barrier. See Figure 1.**
- **Not for use with non-insulated conductors.**











**⚠ Caution**

**To avoid damage to the Meter, do not open the Meter for cleaning. Do not use solvents to clean it, and do not immerse it in liquid.**



## Symbols

Table 1 explains the symbols that are used on the Meter or in this manual.

**Table 1. Symbols**

	Do not apply around, or remove from HAZARDOUS LIVE conductors
	Risk of danger. Important information. See Users Manual.
	Risk of Electrical Shock
	Equipment protected by double or reinforced insulation
	Battery
	Low Battery
	Conforms to relevant European Union directives
	DC (Direct Current)
	Do not dispose of this product as unsorted municipal waste. Go to Fluke's web site for recycling information.
 N10140	Conforms to relevant Australian standards
	Conforms to relevant Canadian and US standards
<b>CAT II 300 V</b>	Equipment is designed to protect against transients in equipment in fixed-equipment installations, such as distribution panels, feeders and short branch circuits, and lighting systems in large buildings.

## Specifications

<b>Current Ranges</b>	±20.99 mA	±21.0 mA - ±99.9 mA
<b>Resolution</b>	0.01 mA	0.1 mA
<b>Accuracy</b>		
20.99 mA range	0.2 % reading ±5 digits	
99.9 mA range	1 % reading ±5 digits	
<b>Maximum Reading</b>	±99.9 mA	
<b>Influence of Earth's Field</b>	< 0.20 mA	
<b>Battery</b>	2 AA 1.5 V Alkaline, IEC LR6	
<b>Working hours</b>	45 hours	
<b>Size (H X W X L)</b>	59 mm x 38 mm x 212 mm (2.32 in x 1.49 in x 8.34 in) (with clamp nested)	
<b>Weight</b>	260 g (9.17 oz) (Including battery)	
<b>Operating Temperature</b>	-10 to 50 °C (14 to 122 °F)	
<b>Storage Temperature</b>	-25 to 70 °C (-13 to 158 °F)	
<b>Operating Humidity</b>	< 90 % @ <30 °C (86 °F) <75 % @ 30 to 50 °C (86 to 122 °F)	
<b>Operating Altitude</b>	0 to 2000 m (1.24 miles)	
<b>Storage Altitude</b>	None	
<b>IP Rating</b>	IP 40	
<b>Vibration Requirements</b>	Random 2 g, 5 to 500 Hz	
<b>EMI, RFI, EMC</b>	Meets all applicable requirements in EN 61326-1	
<b>Temperature Coefficients</b>	0.1x(specified accuracy)/°C (< 18 °C or > 28 °C)	
<b>Measurement Category</b>	IEC 61010-1 61010-2-032 CAT II 300 V  CAT II Equipment is designed to protect against transients from energy-consuming equipment supplied from the fixed installation, such as TVs, PCs, portable tools, and other household appliances.	
<b>Agency Approvals</b>	   <b>FCC</b> N10140	

**Getting Acquainted with the Meter**

Figure 1 shows the Meter functions and features.

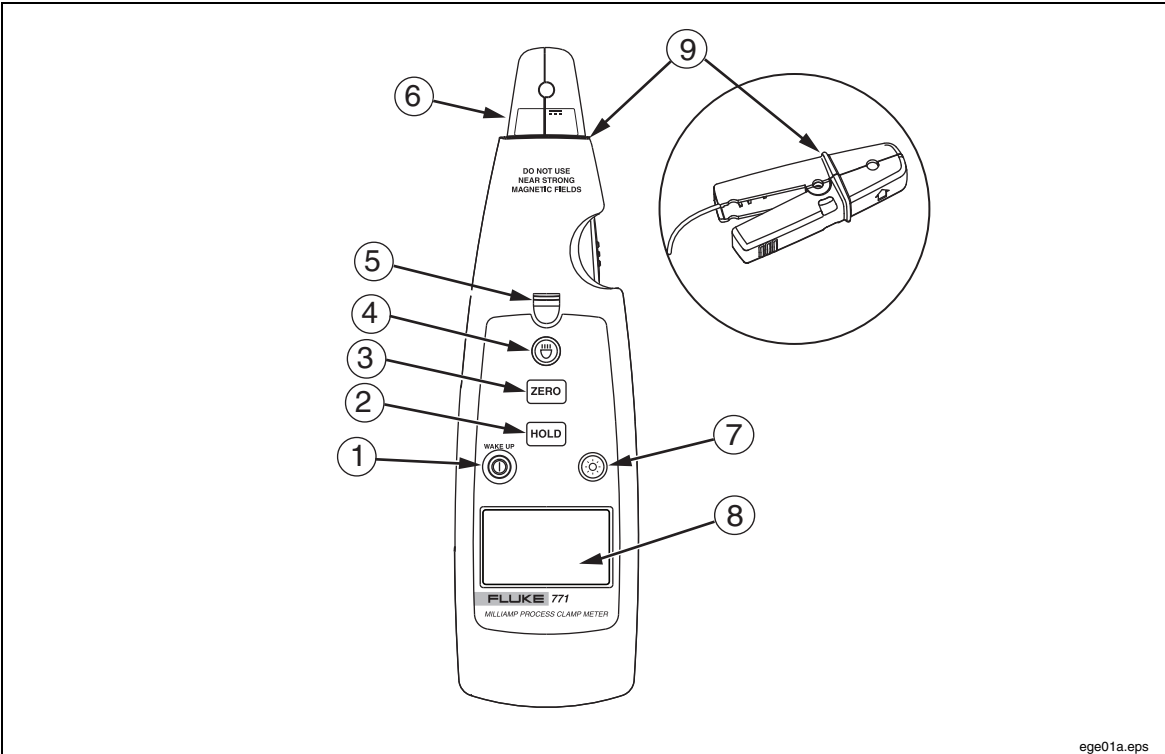

ege01a.eps

Number	Description
①	Turns the Meter on and off. When the Meter is in sleep mode, press this button to wake it up.
②	Captures and holds the current reading
③	Removes interference and zeros the display
④	Measurement spotlight LED button
⑤	Measurement spotlight LED
⑥	Detachable clamp
⑦	Turns the backlight off and on
⑧	LCD
⑨	Tactile Barrier docked and un-docked

**Figure 1. The 771 Milliamp Process Clamp Meter**

## **Maintenance**

### **⚠⚠ Warning**

To avoid possible electric shock or personal injury, repairs or servicing not covered in this manual should be performed only by qualified personnel.

### **Cleaning the Meter**

#### **⚠⚠ Warning**

To avoid electrical shock, remove any input signals before cleaning.

#### **⚠ Caution**

To avoid damaging the Meter, do not use aromatic hydrocarbons or chlorinated solvents for cleaning. These solutions will react with the plastics used in the Meter.

Clean the instrument case with a damp cloth and mild detergent.

### **Battery Replacement**

#### **⚠⚠ Warning**

To avoid false readings, that could lead to possible electric shock or personal injury, replace the battery as soon as the low battery indicator (⚡) appears.

To replace the batteries, see Figure 2:

1. Turn the Meter off.
2. Use a flat head screwdriver to loosen the battery access door fastener, and remove the door from the case bottom.
3. Remove the batteries.
4. Replace the batteries with two new AA batteries.
5. Reattach the battery access door to the case bottom and tighten the fastener.

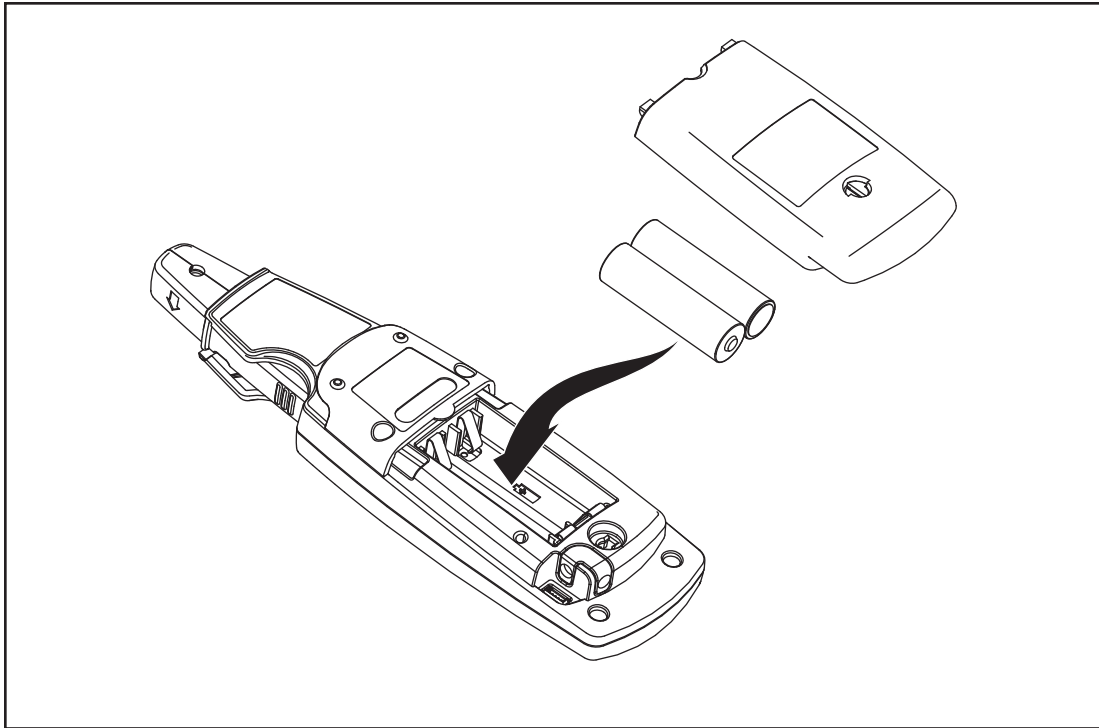

ege02.eps

**Figure 2. Changing the Batteries**

## Performance Tests

### ⚠⚠ Warning

To avoid electrical shock, personal injury, or fire:

- Do not perform the verification tests or calibration adjustment described in this manual unless you are qualified to do so.
- Repairs or servicing should be performed only by qualified personnel.

The following tests are used to verify the functions of the Meter. If the Meter fails any of the verification tests, repair is necessary. For service, see Contacting Fluke.

### Required Equipment

Required equipment for the performance tests is listed in Table 2. If the recommended models are not available, equipment with equivalent specifications may be used.

Table 2. Required Equipment

Equipment	Minimum Required Characteristics	Recommended Model
Calibrator	DC Current Accuracy: Range: 20.99 mA = 0.11 % 99.9 mA = 0.375 %	5520A or equivalent
1 loop insulated copper wire	Insulated 18 gauge, minimum, copper wire, 6 inch diameter	

### Testing the Batteries

Prior to performing the following tests, check the batteries with a multimeter and replace as necessary. See Battery Replacement.



### Testing the Display

1. Press and hold **ZERO** while powering on the Meter.
2. Compare the Meter display to Figure 3.
3. Check all display segments for clarity and contrast.

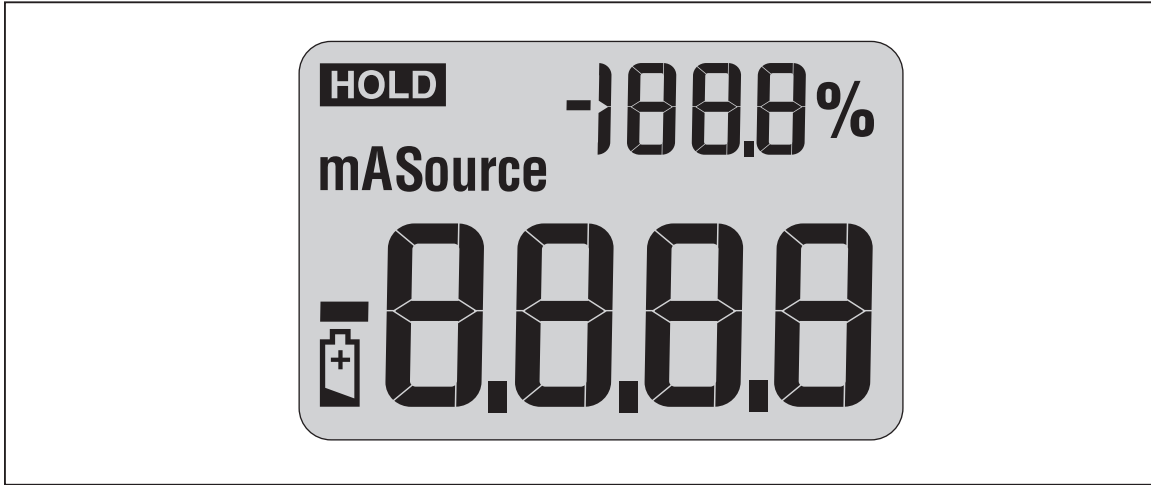



Figure 3. Display Test

fdp1.eps

### Display Hold Test

1. Power on the Meter and allow time for the normal operating display to appear.
2. Press **HOLD** and observe that **HOLD** appears on the display. **HOLD** flashes at 3 to 4 second intervals.

### Backlight Test

1. Power on the Meter and allow time for the normal operating display to come up.
2. Press  and observe that the backlight comes on.

### Spotlight LED Test

1. Power on the Meter and allow time for the normal operating display to come up.
2. Press  and observe that the spotlight LED comes on.

### Zero Test

1. Power on the Meter and allow time for the normal operating display to come up.
2. Press **ZERO**. The main display momentarily reads **0.00**, and the percentage scale momentarily reads **-25.0%**.

### Accuracy Tests

Accuracy specifications are valid for 1 year after calibration when measured at an operation temperature of 18 °C to 28 °C. Allow the Meter to stabilize at room temperature prior to performing the accuracy tests.

Table 3 lists the required performance test points for verifying Meter accuracy. A zero adjustment must be performed prior to completing each performance test point.

Perform the tests as follows:

1. Connect a single loop of 14 gauge insulated copper wire to the calibrator **AUX** output terminals.
2. Clamp the Meter jaw around the wire with the jaw arrow pointing toward the calibrator **HI** terminal.
3. Output 0 mA dc from the calibrator.
4. Press **ZERO** on the Meter.
5. Set the calibrator output for the value in Step 1 of Table 3.
6. Compare the Meter displayed reading with the display reading limits in Table 3.
7. Complete steps 2-4 for each calibrator output setting in Table 3.
8. If the Meter fails to meet any of the Display Reading Limits, it requires calibration adjustment, or repair. See Calibration Adjustment or Contacting Fluke.

**Table 3. Accuracy Tests**

Step	Unit Under Test Function	Calibrator Output Setting	Unit Under Test Display Reading Limits	
			Lower Limit	Upper Limit
1.	mA dc	100 mA dc	98.5	101.5
2.		-100 mA dc	-100.7	-99.3
3.		20 mA dc	19.91	20.09
4.		-20 mA dc	-20.09	-19.91
5.		12 mA dc	11.93	12.07
6.		-12 mA dc	-12.07	-11.93
7.		4 mA dc	3.94	4.06
8.		-4 mA dc	-4.06	-3.94

## Calibration Adjustment

### Adjustment Subroutines

The Meter features closed-case calibration adjustment using a known reference source. The Meter measures the applied reference source, calculates correction factors, and stores the correction factors in nonvolatile memory.

There are four adjustment subroutines in the Meter adjustment procedure:



- Low Range ( $\pm 20$  mA)
- High range ( $\pm 100$  mA)
- Temperature
- Phase



#### Note

*Temperature adjustment should always be performed prior to performing the other adjustment routines. The phase adjustment routine is ONLY required if the unit is repaired or the current clamp is replaced.*

### Front Panel Operation for Adjustment

Use a small probe to press the calibration button once to enter the Meter's calibration mode. The calibration button is usually covered by the factory calibration seal. A second press of the button saves new calibration constants and exits calibration mode. See Figure 4.

In calibration mode,  is used to select subroutines: low range, high range, temperature, or phase. A short press of  (<1 second) will toggle between low and high range subroutines. A long press (>1 second) will toggle between temperature and phase subroutines.

- Pressing **ZERO** is valid for all subroutines and normal operation. Pressing **ZERO** will zero the reading.
- In the low and high range subroutines, **HOLD** and  are used to adjust the negative and positive gain of the range.
- In the temperature subroutine, only **HOLD** is valid for adjustment.
- In the phase subroutine, **HOLD** and  are used to adjust the phase of two sensor-excitation signals by increasing or decreasing a parameter.

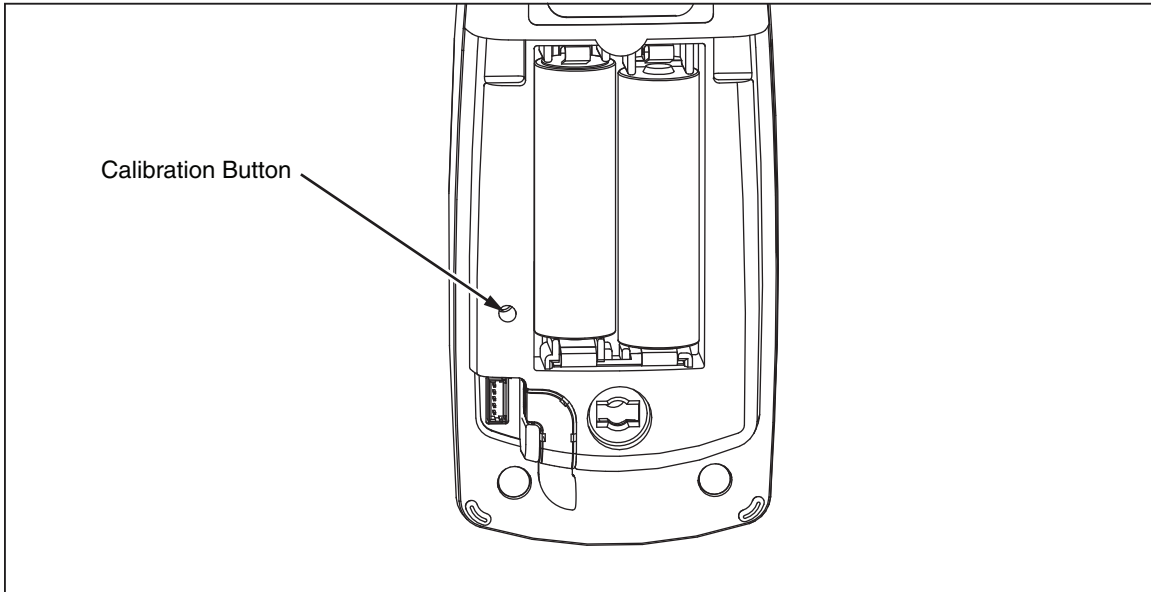

Figure 4. Accessing the Calibration Button

fdp3.eps

### Calibration Error Messages

Table 4 lists the calibration error messages that can be shown on the Meter display. The suggested actions to eliminate messages are also listed.

Table 4. Error Messages

Error Message	Cause of Error	Suggested Action
CAL ERR1	The difference between the input level and the zero point is less than the minimal threshold when performing low range and high range adjustments.	Check current loop and ensure correct current is generated.
CAL ERR2	Calibration parameter checksum failure.	Execute all adjustments including temperature and phase.
CAL ERR3	Code checksum failure.	The Meter requires repair.



### Calibration Adjustment Procedure

Allow the Meter to stabilize to room temperature before beginning the calibration adjustment.





To prepare for adjustment:

1. Remove the battery door and calibration seal.
2. Clamp the current loop in the current flow direction where required.
3. Turn the meter on and wait at least 10 seconds for warming up.
4. Press the hidden calibration button with a probe to enter calibration mode. See Figure 4.





### Temperature Adjustment Procedure

1. Press  for >1 second until **t23** appears on the percentage display.
2. Wait at least 60 seconds for the internal temperature to balance.
3. Press  to adjust the temperature.

### Low Range Adjustment Procedure

1. Clamp the Meter's current clamp around an insulated 18 gauge, copper wire, with 6-inch diameter. Current flow should be in the direction of the arrow on the current clamp.
2. Press  < 1 second until **CAL 20** appears on percentage display.
3. Output 0  $\mu$ A dc from the calibrator.
4. Wait at least 15 seconds for the Meter's internal circuits to stabilize.
5. Press  on the Meter to zero the reading.
6. Output 20 mA dc from the calibrator.
7. Wait at least 15 seconds for the Meter's internal circuits to stabilize.
8. Press  on the Meter to adjust the positive gain.
9. Output -20 mA dc from the calibrator.
10. Wait at least 15 seconds for the Meter's internal circuits to stabilize.
11. Press  on the Meter to adjust the negative gain.

### High Range Adjustment Procedure

1. Clamp the Meter's current clamp around an insulated 18 gauge, copper wire, with 6-inch diameter. Current flow should be in the direction of the arrow on the current clamp.
2. Press  < 1 second until **CAL 100** appears on percentage display.
3. Output 0  $\mu$ A dc from the calibrator.
4. Wait at least 15 seconds for the Meter's internal circuits to stabilize.
5. Press  on the Meter to zero the reading.
6. Output 100 mA dc from the calibrator.
7. Wait at least 15 seconds for the Meter's internal circuits to stabilize.
8. Press  on the Meter to adjust the positive gain.
9. Output -100 mA dc from the calibrator.
10. Wait at least 15 seconds for the Meter's internal circuits to stabilize.
11. Press  on the Meter to adjust the negative gain.

#### Note

*The following procedure is not required unless the Meter's current clamp has been replaced.*

### Phase Adjustment Procedure

1. Clamp the Meter's current clamp around an insulated 18 gauge, copper wire, with 6-inch diameter. Current flow should be in the direction of the arrow on the current clamp.
2. Press  $\odot$  >1 second until the percentage display indicates the Meter's currently saved phase value.
3. Output 0  $\mu$ A dc from the calibrator.
4. Press **ZERO** on the Meter to zero the reading.
5. Rotate the Meter's clamp around the current loop conductor and record the minimum and maximum values of the Meter's display reading. See Figure 5.
6. Use  $\odot$  and **HOLD**, to adjust the difference between the minimum and maximum value recorded in Step 5, until the reading difference is less than 0.05 mA.

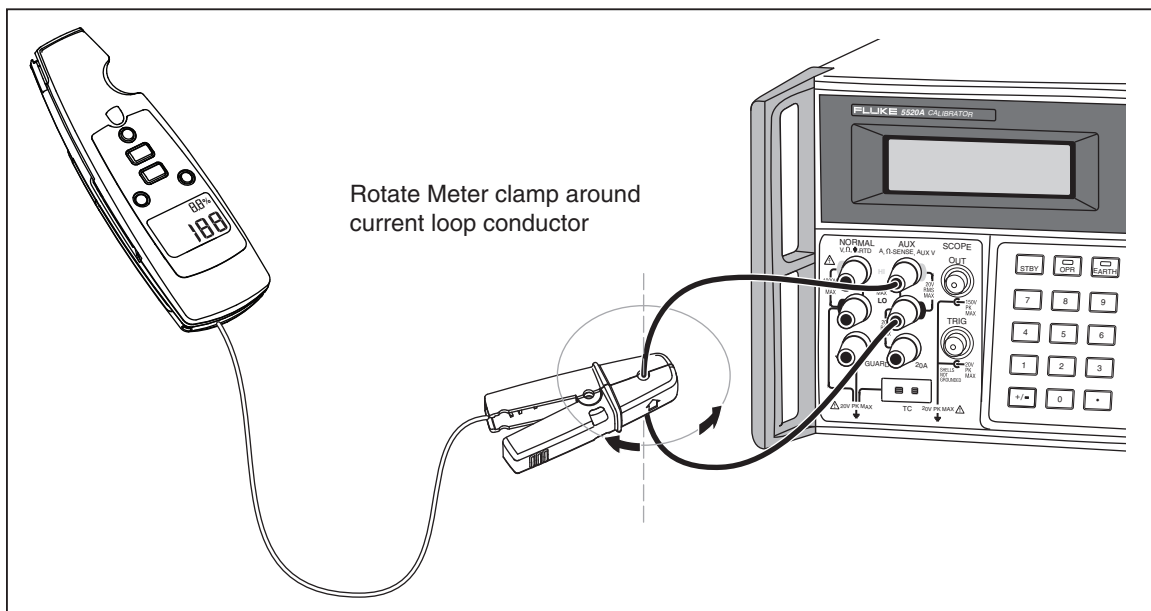

Figure 5. Phase Adjustment

fdp5.eps

## User Replaceable Parts

Table 5 and Figure 6 list all user replaceable parts.

**Table 5. Replaceable Parts**

Item ID	Description	P/N	Qty
①	Decal	2723063	1
②	Case top assembly (does not include decal, order separately)	2720362	1
③	Keypad	2723056	1
④	Jaw assembly (Includes cable)	2722971	1
⑤	Screw,m2.2x0.8,8mm,pan,phillips,steel,zinc-black chromate, thread form	1991287	2
⑥	Case, bottom (does not include battery contact, order separately)	2720285	1
⑦	Cable cleat	2720328	1
⑧	Screw,4-14,.375,pan,phillips,steel, zinc-black chromate, thread form	2800097	2
⑨	Battery contact, dual	666435	1
⑩	Screw,m3,13.5mm,pan,phillips,steel,zinc-black chromate, thread form	2388412	2
⑪	Battery,primary,mno2-zn,1.5v,2.24ah,15a,lr6,alkaline,aa,14x50mm,bulk	376756	2
⑫	Battery pad,urethane,adhesive-back,20.0mm l,20.0mm w,5.0mm thk	2687457	1
⑬	Battery door (does not include fastener, order separately)	2720304	1
⑭	Access door fastener	948609	1
⑮	LED housing	2720319	1
-	Soft case, black/yellow	2726174	1
-	<i>771 Instruction Sheet</i>	2567301	1

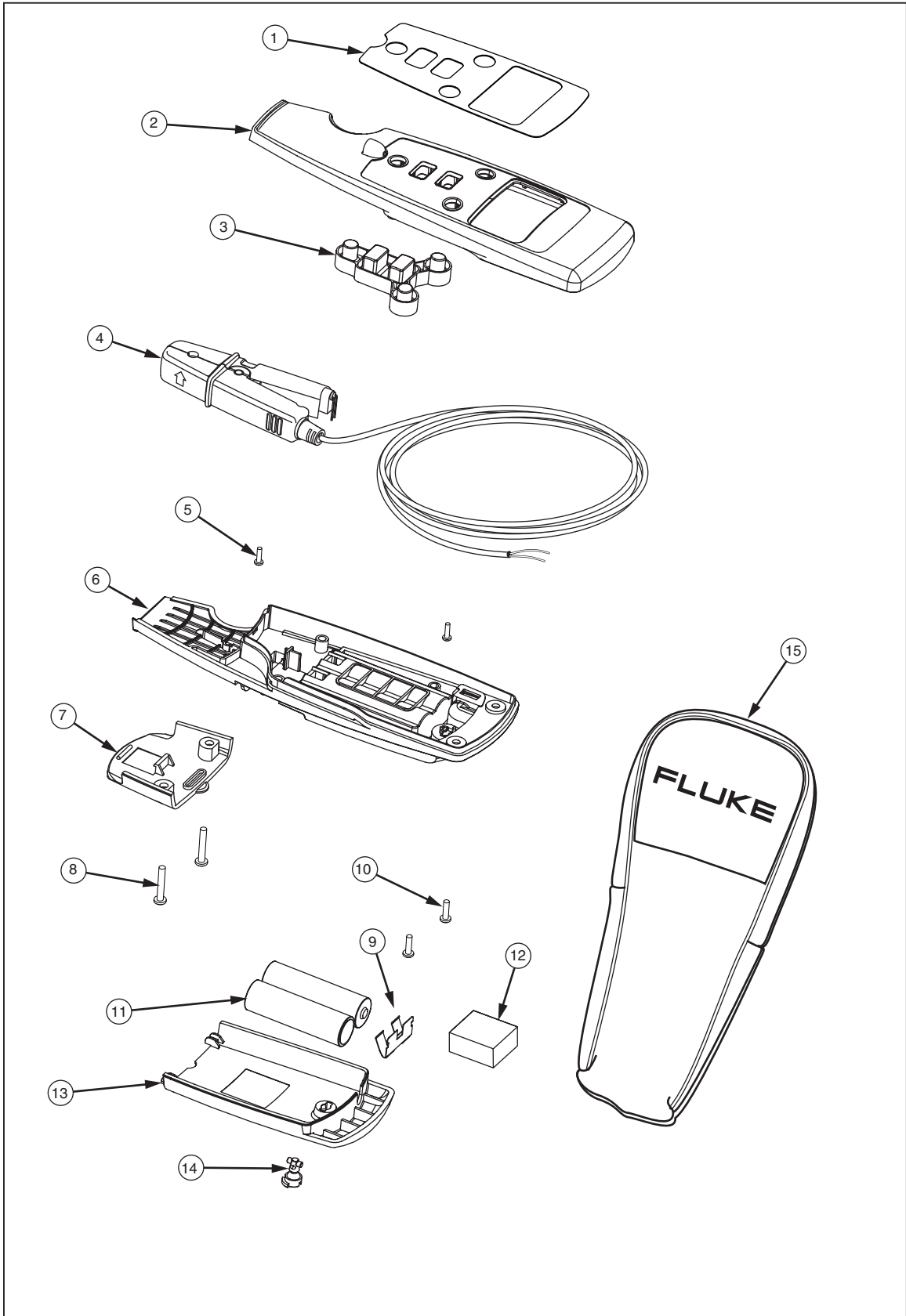

Figure 6. Replaceable Parts

fdp4.eps