

# SKKT 72, SKKH 72, SKKT 72B



## SEMIPACK<sup>®</sup> 1

### Thyristor / Diode Modules

**SKKT 72**  
**SKKH 72**  
**SKKT 72B**

#### Features

- Heat transfer through aluminium oxide ceramic isolated metal baseplate
- Hard soldered joints for high reliability
- UL recognized, file no. E 63 532

#### Typical Applications\*

- DC motor control (e. g. for machine tools)
- AC motor soft starters
- Temperature control (e. g. for ovens, chemical processes)
- Professional light dimming (studios, theaters)

1) See the assembly instructions

| $V_{RSM}$<br>V | $V_{RRM}, V_{DRM}$<br>V | $I_{TRMS} = 125 \text{ A}$ (maximum value for continuous operation)<br>$I_{TAV} = 70 \text{ A}$ (sin. 180; $T_c = 85 \text{ °C}$ ) |             |             |
|----------------|-------------------------|--|-------------|-------------|
|                |                         | SKKT 72/08E  | SKKT 72B08E | SKKH 72/08E |
| 900            | 800                     | SKKT 72/08E  | SKKT 72B08E | SKKH 72/08E |
| 1300           | 1200                    | SKKT 72/12E  | SKKT 72B12E | SKKH 72/12E |
| 1500           | 1400                    | SKKT 72/14E  | SKKT 72B14E | SKKH 72/14E |
| 1700           | 1600                    | SKKT 72/16E  | SKKT 72B16E | SKKH 72/16E |
| 1900           | 1800                    | SKKT 72/18E  | SKKT 72B18E | SKKH 72/18E |

| Symbol           | Conditions  | Values                     | Units            |
|------------------|---|----------------------------|------------------|
| $I_{TAV}$        | sin. 180; $T_c = 85$ (100) °C;                          | 70 (50)                    | A                |
| $I_D$            | P3/180; $T_a = 45$ °C; B2 / B6                          | 62 / 75                    | A                |
|                  | P3/180F; $T_a = 35$ °C; B2 / B6                         | 115 / 145                  | A                |
| $I_{RMS}$        | P3/180F; $T_a = 35$ °C; W1 / W3                         | 155 / 3 * 115              | A                |
| $I_{TSM}$        | $T_{vj} = 25$ °C; 10 ms                                 | 1600                       | A                |
|                  | $T_{vj} = 125$ °C; 10 ms                                | 1450                       | A                |
| $i^2t$           | $T_{vj} = 25$ °C; 8,3 ... 10 ms                         | 13000                      | A <sup>2</sup> s |
|                  | $T_{vj} = 125$ °C; 8,3 ... 10 ms                        | 10500                      | A <sup>2</sup> s |
| $V_T$            | $T_{vj} = 25$ °C; $I_T = 300$ A                         | max. 1,9                   | V                |
| $V_{T(TO)}$      | $T_{vj} = 125$ °C                                       | max. 0,9                   | V                |
| $r_T$            | $T_{vj} = 125$ °C                                       | max. 3,5                   | mΩ               |
| $I_{DD}, I_{RD}$ | $T_{vj} = 125$ °C; $V_{RD} = V_{RRM}, V_{DD} = V_{DRM}$ | max. 20                    | mA               |
| $t_{gd}$         | $T_{vj} = 25$ °C; $I_G = 1$ A; $di_G/dt = 1$ A/μs       | 1                          | μs               |
| $t_{gr}$         | $V_D = 0,67 * V_{DRM}$                                  | 1                          | μs               |
| $(di/dt)_{cr}$   | $T_{vj} = 125$ °C                                       | max. 150                   | A/μs             |
| $(dv/dt)_{cr}$   | $T_{vj} = 125$ °C                                       | max. 1000                  | V/μs             |
| $t_q$            | $T_{vj} = 125$ °C,                                      | 80                         | μs               |
| $I_H$            | $T_{vj} = 25$ °C; typ. / max.                           | 150 / 250                  | mA               |
| $I_L$            | $T_{vj} = 25$ °C; $R_G = 33$ Ω; typ. / max.             | 300 / 600                  | mA               |
| $V_{GT}$         | $T_{vj} = 25$ °C; d.c.                                  | min. 3                     | V                |
| $I_{GT}$         | $T_{vj} = 25$ °C; d.c.                                  | min. 150                   | mA               |
| $V_{GD}$         | $T_{vj} = 125$ °C; d.c.                                 | max. 0,25                  | V                |
| $I_{GD}$         | $T_{vj} = 125$ °C; d.c.                                 | max. 6                     | mA               |
| $R_{th(j-c)}$    | cont.; per thyristor / per module                       | 0,35 / 0,18                | K/W              |
| $R_{th(j-c)}$    | sin. 180; per thyristor / per module                    | 0,37 / 0,19                | K/W              |
| $R_{th(j-c)}$    | rec. 120; per thyristor / per module                    | 0,39 / 0,2                 | K/W              |
| $R_{th(c-s)}$    | per thyristor / per module                              | 0,2 / 0,1                  | K/W              |
| $T_{vj}$         |   | - 40 ... + 125             | °C               |
| $T_{stg}$        |   | - 40 ... + 125             | °C               |
| $V_{isol}$       | a. c. 50 Hz; r.m.s.; 1 s / 1 min.                       | 3600 / 3000                | V~               |
| $M_s$            | to heatsink   | $5 \pm 15$ % <sup>1)</sup> | Nm               |
| $M_t$            | to terminals  | $3 \pm 15$ %               | Nm               |
| $a$              |   | $5 * 9,81$                 | m/s <sup>2</sup> |
| $m$              | approx.   | 95                         | g                |
| Case             | SKKT  | A 46                       |                  |
|                  | SKKT ...B   | A 48                       |                  |
|                  | SKKH  | A 47                       |                  |

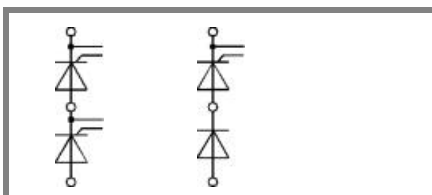

**SKKT**      **SKKH**

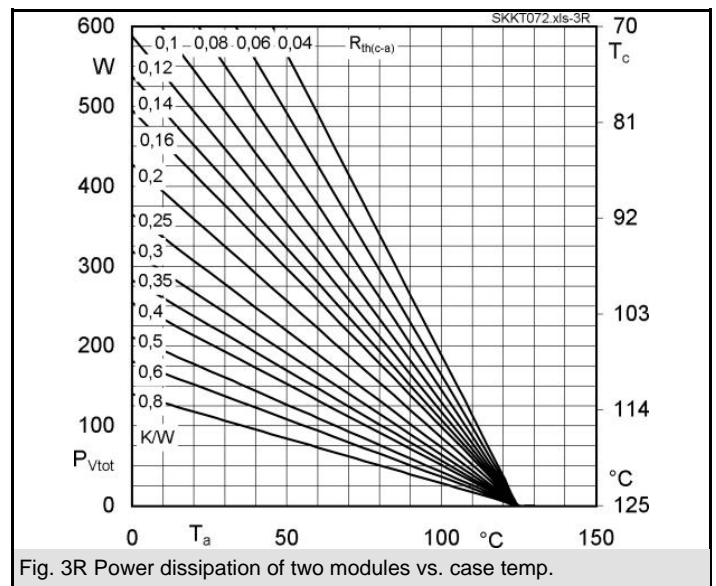
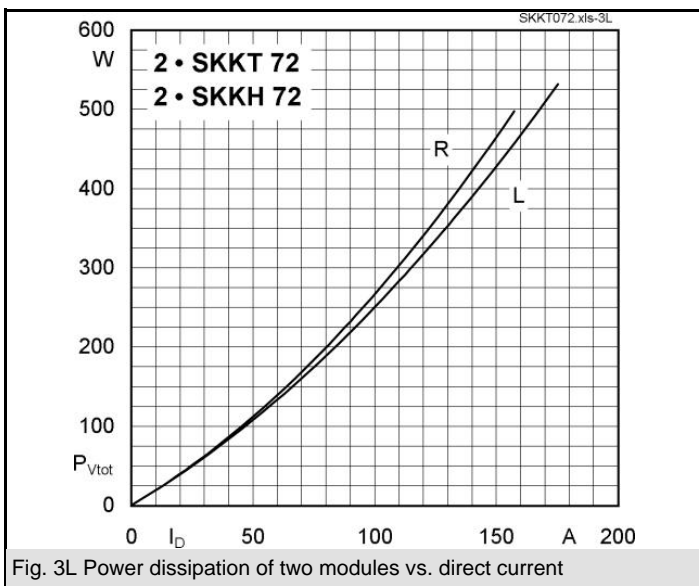
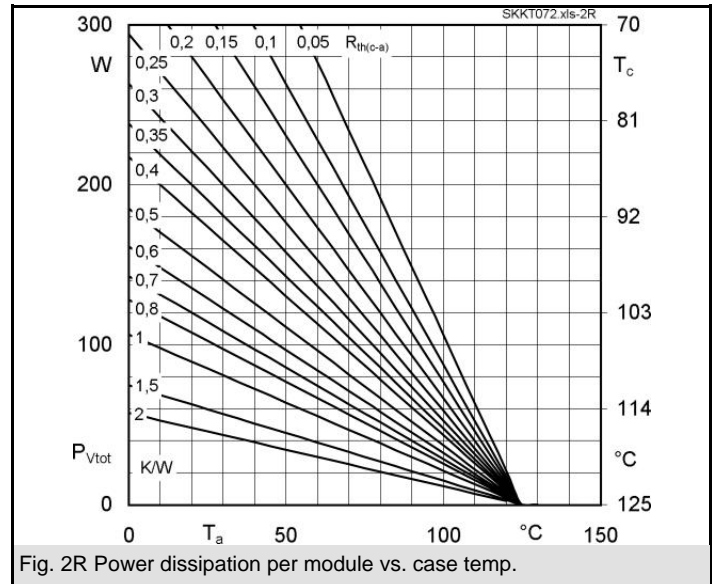
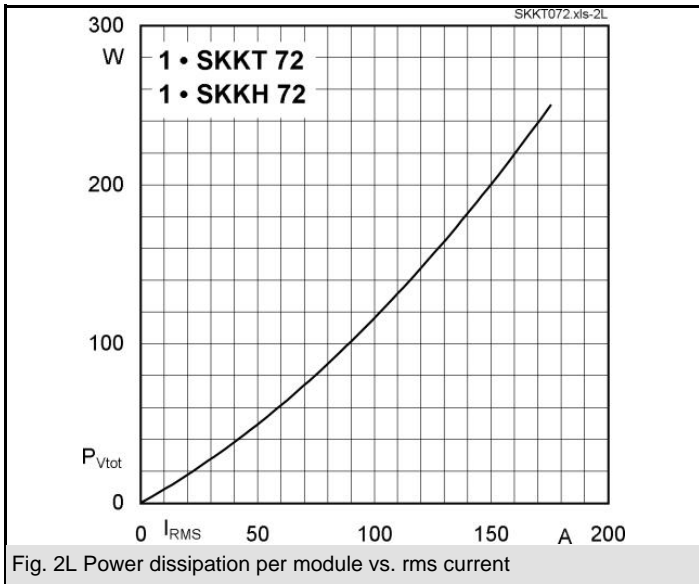
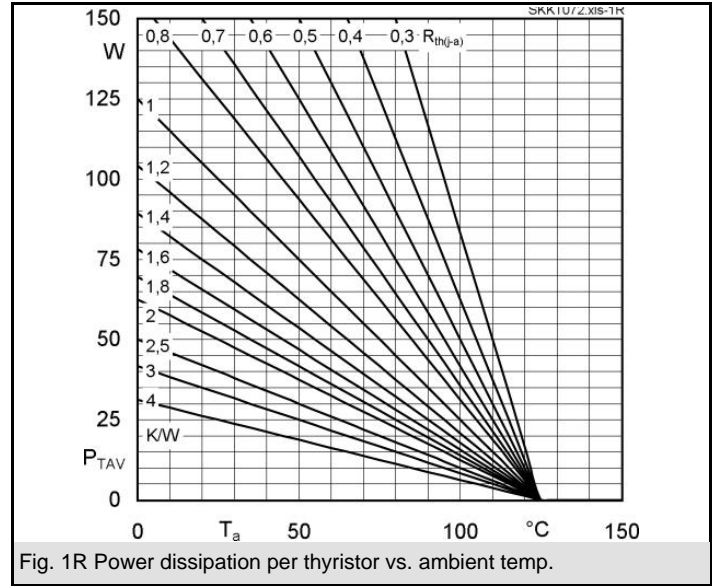
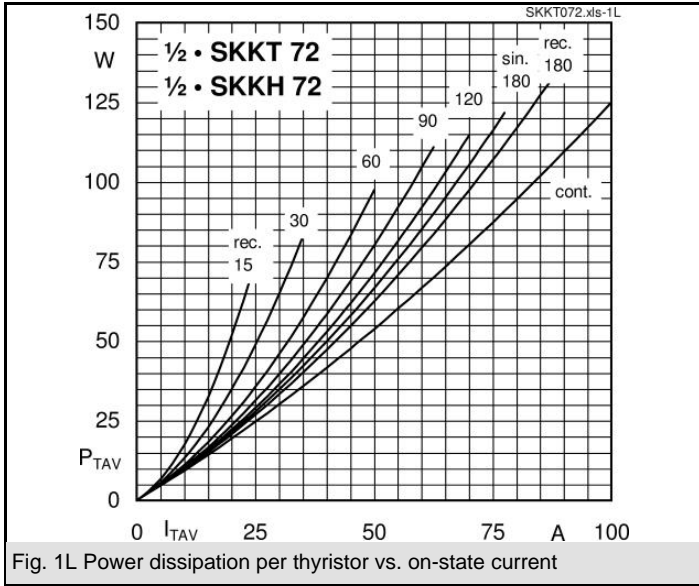

# SKKT 72, SKKH 72, SKKT 72B

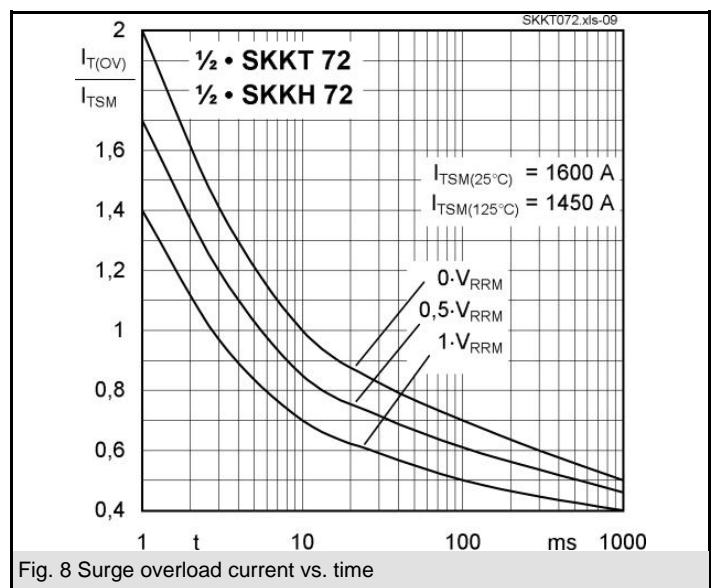
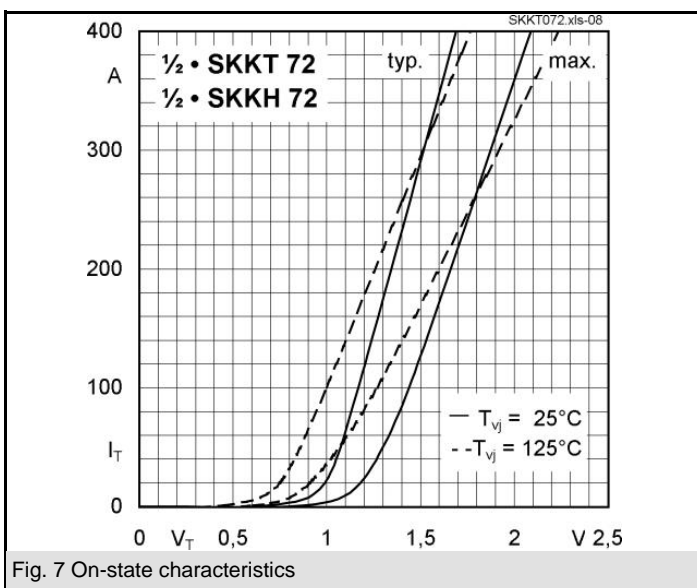
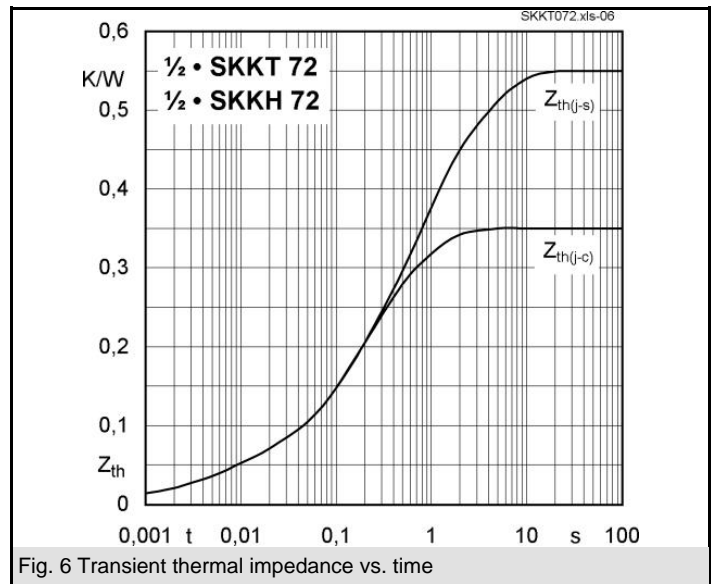
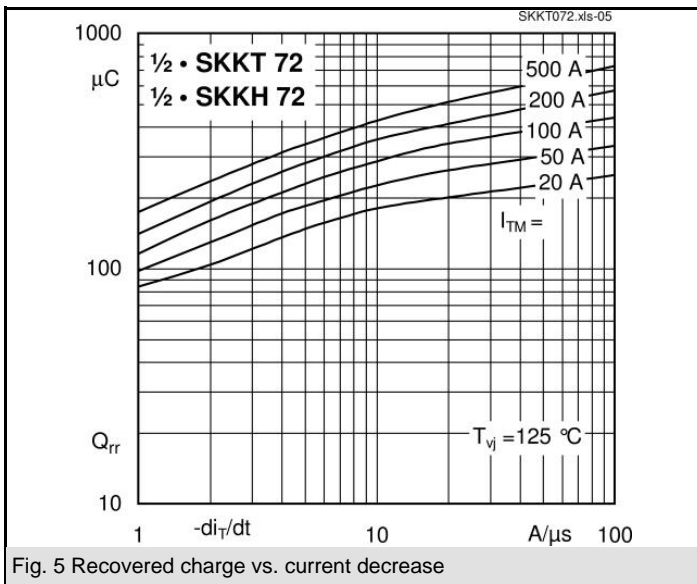
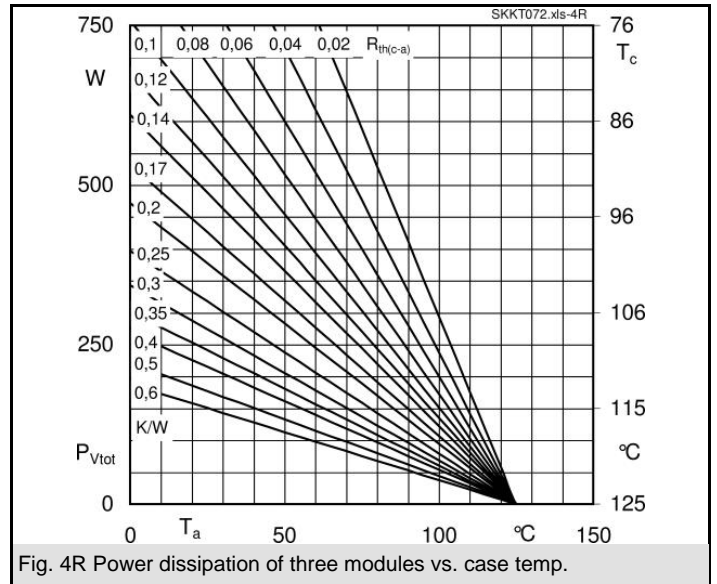
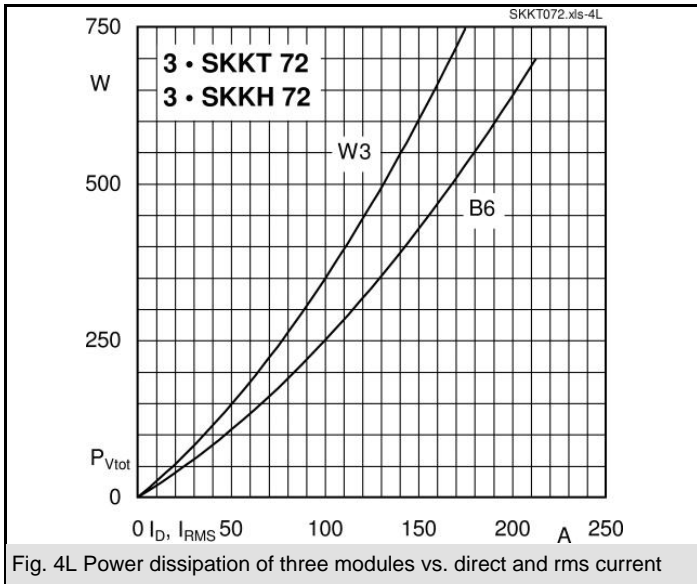

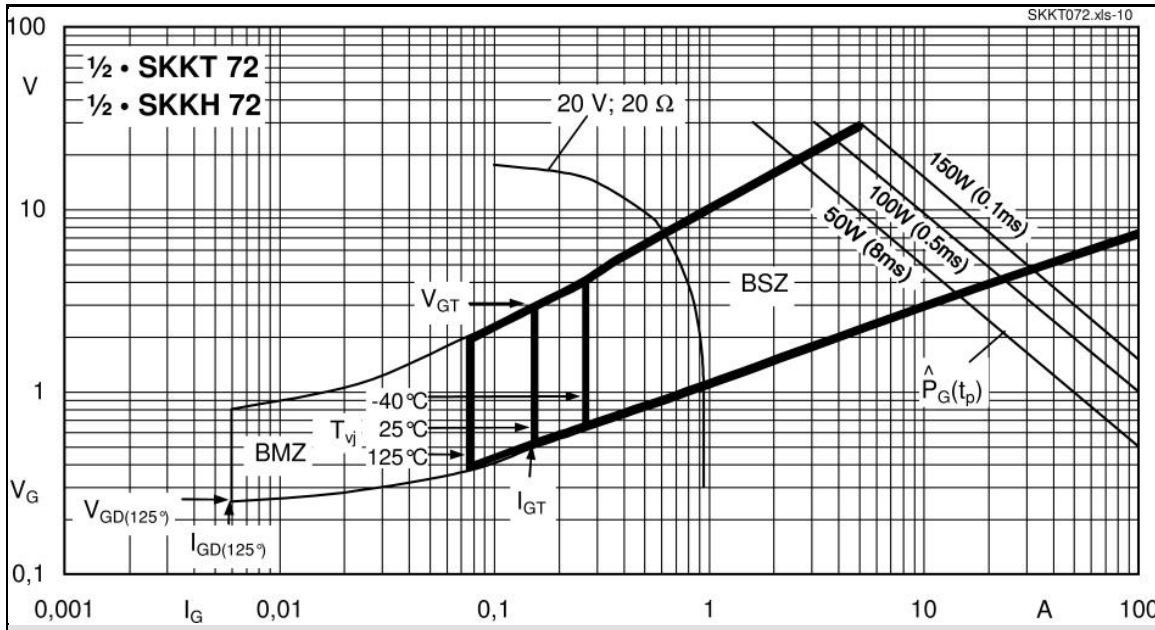
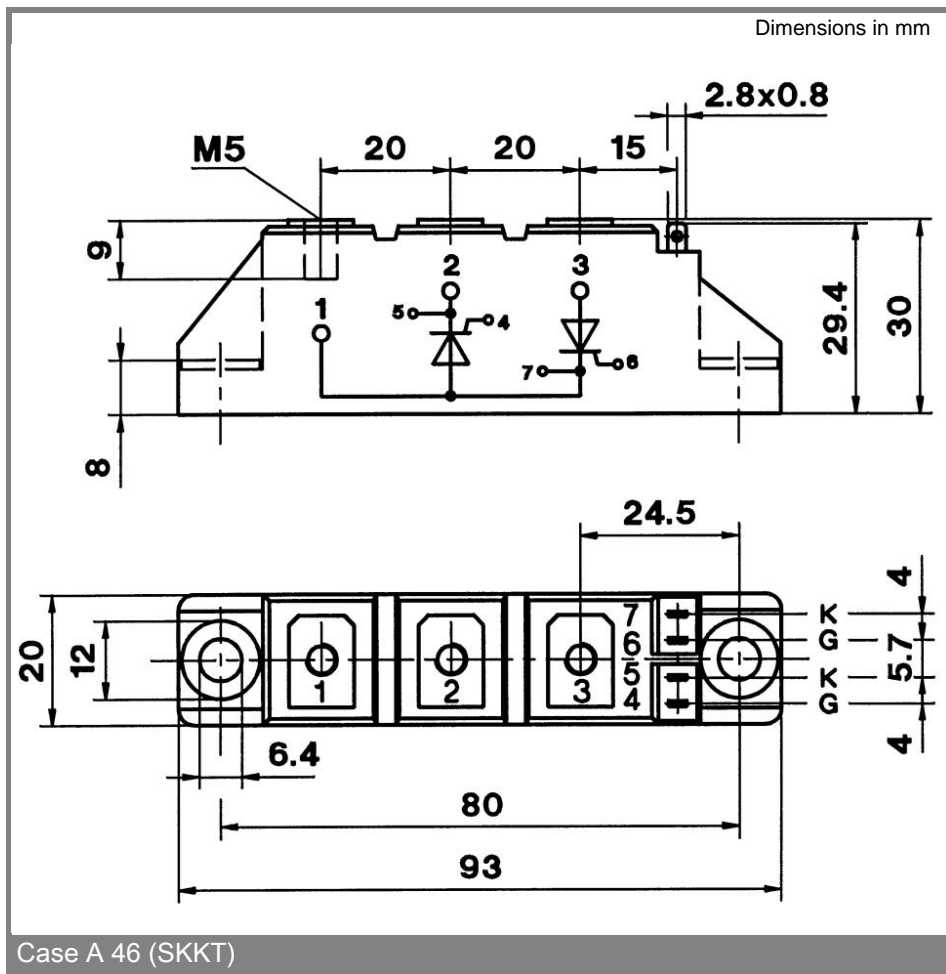
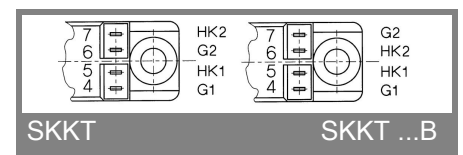
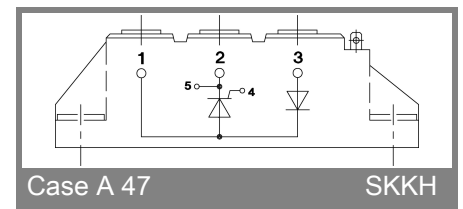
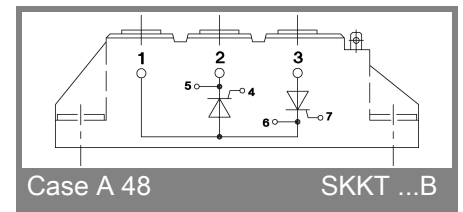

Fig. 9 Gate trigger characteristics



Case A 46 (SKKT)



\* The specifications of our components may not be considered as an assurance of component characteristics. Components have to be tested for the respective application. Adjustments may be necessary. The use of SEMIKRON products in life support appliances and systems is subject to prior specification and written approval by SEMIKRON. We therefore strongly recommend prior consultation of our personal.