

Programa*stat*

Wireless 7 Day Programmable Room Thermostat

Cat. No. TRT037



Transmitter



Receiver

Operating & Installation Instructions



A **theben** Group Company

What is a programmable room thermostat?

... an explanation for householders

A programmable room thermostat is both a programmer and a room thermostat. A programmer allows you to set 'On' and 'Off' time periods to suit your own lifestyle. A room thermostat works by sensing the air temperature, switching on the heating when the air temperature falls below the thermostat setting, and switching it off once this set temperature has been reached.

So, a programmable room thermostat lets you choose what times you want the heating to be on, and what temperature it should reach while it is on. It will allow you to select different temperatures in your home at different times of the day (and days of the week) to meet your particular needs.

Turning a programmable room thermostat to a higher setting will not make the room heat up any faster. How quickly the room heats up depends on the design of the heating system, for example, the size of boiler and radiators.

Neither does the setting affect how quickly the room cools down. Turning a programmable room thermostat to a lower setting will result in the room being controlled at a lower temperature, and saves energy.

The way to set and use your programmable room thermostat is to find the lowest temperature settings that you are comfortable with at the different times you have chosen, and then leave it alone to do its job. The best way to do this is to set low temperatures first, say

18oC, and then turn them up by one degree each day until you are comfortable with the temperatures. You won't have to adjust the thermostat further. Any adjustments above these settings will waste energy and cost you more money.

If your heating system is a boiler with radiators, there will usually be only one programmable room thermostat to control the whole house. But you can have different temperatures in individual rooms by installing thermostatic radiator valves (TRVs) on individual radiators. If you don't have TRVs, you should choose a temperature that is reasonable for the whole house. If you do have TRVs, you can choose a slightly higher setting to make sure that even the coldest room is comfortable, then prevent any overheating in other rooms by adjusting the TRVs.

The time on the programmer must be correct. Some types have to be adjusted in spring and autumn at the changes between Greenwich Mean Time and British Summer Time.

You may be able to temporarily adjust the heating programme, for example, 'Override', 'Advance' or 'Boost'. These are explained in the manufacturer's instructions.

Programmable room thermostats need a free flow of air to sense the temperature, so they must not be covered by curtains or blocked by furniture. Nearby electric fires, televisions, wall or table lamps may prevent the thermostat from working properly.



Certification mark

1. Introduction

TRT products are a cost effective comprehensive range of thermostats and controllers designed for internal use only.

The TRT037 is a battery powered wireless electronic programmable room thermostat, with 6 different temperature periods per day, automatic summer/winter time changeover, 5 day plus 2 or individual (7) day programming, and a frost mode. There is also the option of optimum start and adjustable span, from 1°C to 0.5°C.

The TRT037 comes in two parts - a thermostat/transmitter which is battery powered and totally wire-free as well as a receiver which connects into the heating system. This eases the installation in two ways - there is no need to bury cable runs to the thermostat/transmitter and the receiver can be mounted close to the boiler and other system components.

The two parts are designed to be surface mounted on their supplied wall plates.

The electrical supply **must** be isolated before attempting to install the receiver unit.

TRT037 Wireless Programmable Room Thermostat/Transmitter

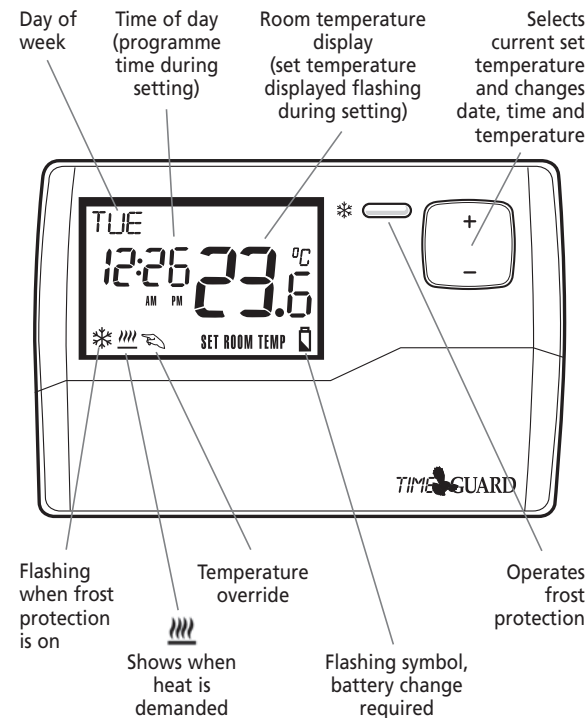

Fig. 1

TRT037 Wireless Programmable Room Thermostat/Transmitter

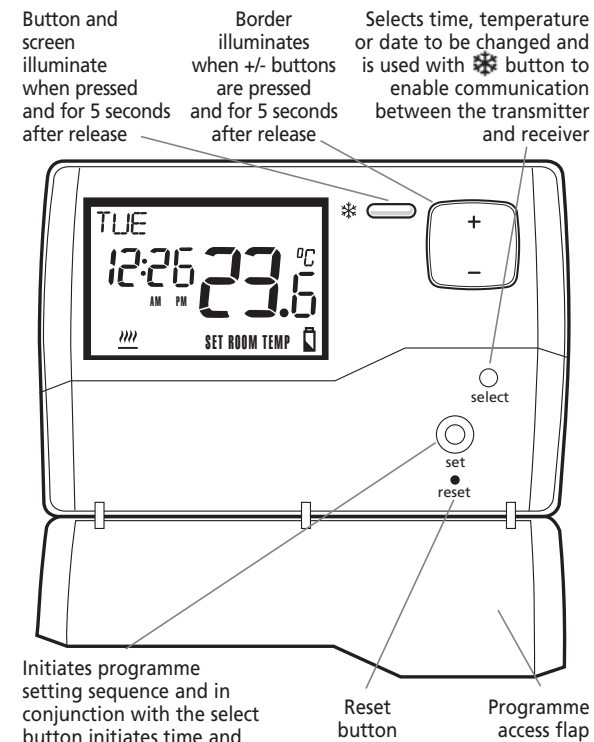

Fig. 1a

TRT037 Receiver Front View

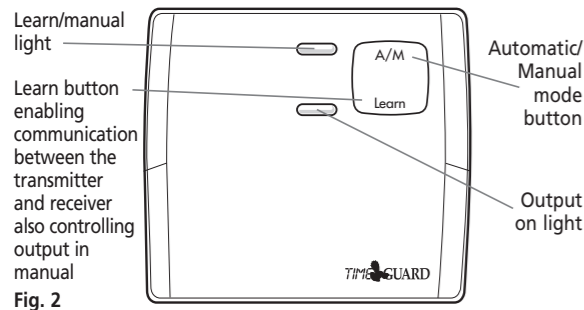

Fig. 2

TRT037 Transmitter Rear View

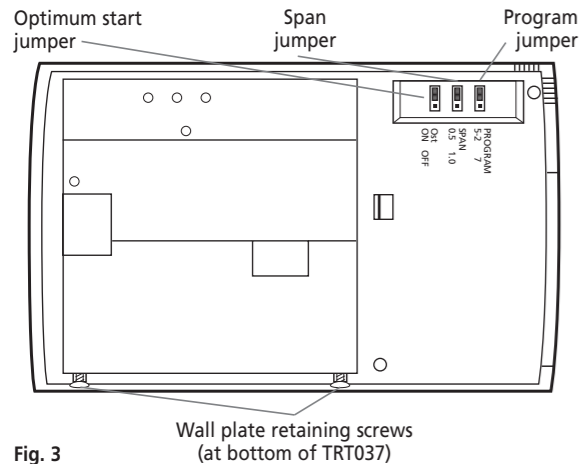

Fig. 3

Receiver Back Plate Removed

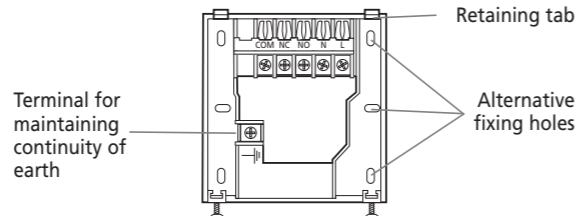

Fig. 4 Mount the wall plate in this configuration only

Transmitter Back Plate Removed

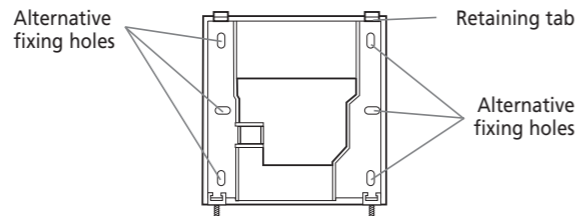

Fig. 5 Mount the wall plate in this configuration only

Battery Holder Removal

Lever battery holder outwards using a large flat bladed screwdriver (shown) or a large coin.

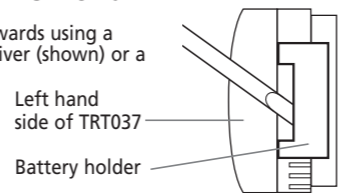

Fig. 6

Contents

- TRT037 thermostat
- TRT037 wall plate
- TRT037 instruction leaflet
- 4 x wall plugs
- 4 x screws
- 2 x AA batteries
- TRT037 receiver
- TRT037 receiver wall plate

2. Siting

The TRT037 transmitter must be sited where it would not be influenced by heat sources, for example, above a radiator or television or refrigerator/freezer, or in direct sunlight or subject to draughts. The product requires air circulation, so do not position above or below shelving or other wall mounted obstacles.

It should be mounted approximately 1.5m above floor level.

The TRT037 receiver should be mounted close to the items it will be controlling i.e. boiler, control valves and pump. It should be mounted in a position where its control buttons and indicator lights can be easily accessed.

3. Installation

This product must be installed in accordance with the appropriate building and wiring regulations.

In all cases if there is a doubt as to how to proceed with an installation consult a qualified electrician, your local authority's building control department or the Timeguard helpline (020 8450 0515).

The TRT037 transmitter and receiver are designed to be surface mounted on their supplied wall plates.

Always isolate the mains supply before removing the receiver from its wall plate.

Transmitter

Lever the battery holder out using a large flat blade screwdriver or large coin (see Fig. 6) and then pull out fully.

Insert the 2 x AA alkaline batteries supplied into the battery holder maintaining the correct polarity as shown in the base of the battery holder.

Push the battery holder back into place until it clicks shut.

Remove wall plate from unit, by undoing retaining screws (see Fig. 5), and pivoting the bottom of the wall plate outwards. The TRT037 transmitter can then be lifted off.

Fix wall plate securely to the wall, using screws (and wall plugs if necessary) provided. The screws which secure the TRT037 transmitter to the wall plate should point downwards.

To reinstall the unit on the wall plate first ensure the wall plate retaining screws are loosened enough to clear the TRT037 transmitter body then engage the top of the TRT037 transmitter onto the wall plate retaining tabs (see Fig. 5), and push firmly downwards and then inwards. Once in place, secure with the retaining screws.

Receiver

Isolate 230VAC mains supply. Incoming and outgoing wires should be 1.5 sq mm.

Remove wall plate from unit, by undoing retaining screws (see Fig. 4), and pivoting the bottom of the wall plate outwards. The TRT037 receiver can then be lifted off.

Thread the incoming wires through the hole in the wall plate, and fix wall plate securely to the wall, using screws (and wall plugs if necessary) provided. The screws which secure the TRT037 receiver to the wall plate should point downwards.

Allow sufficient excess cable to wire up the unit, but not too much to make it difficult to close the unit onto the wall plate.

Connect the conductors to the relevant terminals, according to the wiring diagram below (Fig. 7). Ensure that the curved brass washers grip the conductors.

Receiver Wiring Diagram

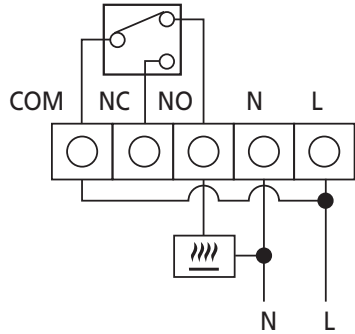

Fig. 7

This unit is double insulated, and hence does not need connection to the earth. If earth continuity is required, please use the earth terminal on the wall plate, (see Fig. 4).

To reinstall the unit on the wall plate first ensure the wall plate retaining screws are loosened enough to clear the TRT037 receiver body then engage the top of the TRT037 receiver onto the wall plate retaining tabs (see Fig. 4), and push firmly downwards and then inwards. There will be some resistance from the terminals. Once in place, secure with the retaining screws.

Finally check that the system wiring is complete and correct.

4. Operation

Initially it is important to get the two parts (transmitter and receiver) talking to each other. This is best carried out by two people, one at each of the separate locations.

Press reset on the transmitter and at the receiver connect the mains supply to the unit. Both indicator lights (learn/manual and output on the receiver) will come on for around 3 seconds and then go out. Press and hold the learn button on the receiver for around 10 seconds until the blue learn/manual light starts flashing.

At the transmitter press and hold the select and  buttons until the flashing blue learn/manual light on the receiver goes out. The transmitter and receiver are now communicating. This can be confirmed by carrying out the following:- at the transmitter press the + button until the set temperature (identified by momentarily pressing the + or - button) is higher than the room temperature (normally displayed). After a short delay the output on light on the receiver comes on.

Now press the - button at the transmitter until the set temperature is lower than the room temperature and after a short delay the output light will turn off. This proves the communication is fully functional.

There is a manual facility available at the receiver. If the auto/manual (A/M) button is pressed the blue

learn/manual light will come on indicating the receiver is in manual mode. The receiver output can now be turned on and off using the learn button.

Programming

Decide whether weekday/weekend (5-2) or individual (7) day programming is required and move the appropriate jumper on the rear of the TRT037 transmitter.

The temperature span (difference between on and off temperatures) can be adjusted between 1°C and 0.5°C using a jumper found on the rear of the unit.

Optimum start (switching on earlier on colder mornings) can also be turned on or off using a jumper on the rear of the unit.

It is important to make these decisions first, as after any change of jumper position, reset needs to be pressed, which will return the unit to default time and programme.

Pressing any button illuminates the screen automatically.

During time/date and programme setting if a button is not pressed within 15 seconds the display will revert to the start of the sequence.

Setting date and time of day

Open programme access flap and press reset, using a pen or similar object. All of the screen segments will show briefly, and then the current room temperature will be displayed.

To programme the date and time of day, open programme access flap, and simultaneously press and hold both the select and set buttons for 3 seconds. The year will flash.

Use the + and - button to set the correct year. Press select to move on to programming the month (shown to the left), and then again to programme the day. Press select again to programme the hours (am/pm), and again to programme the minutes (each time using the +/- button to make the change). Press set to return to operating mode.

If at any time a button is not pressed for 15 seconds, the unit will return to operating mode.

Programming temperature periods for 7 days option

Notes

- 1) There are no off periods with this controller. The programming sequence is:- Start time, temperature, second start time, second temperature and so on. Setting temperature to 10°C is as close to off as can be achieved (and for most situations will be off unless the weather is very cold).
- 2) If you do not want a higher temperature period in the middle of the day adjust the temperature for this period downward to match those of the preceding and subsequent period temperatures.

3) The TRT037 comes with a factory installed (default) programme for both 5-2 and 7 day options which you use or modify as you wish. Just pressing the reset button brings this programme into operation.

The default programme for every day is as follows:-

6:00 AM	21°C
8:00 AM	17°C
12:00 PM	21°C
2:00 PM	17°C
4:00 PM	21°C
10:00 PM	17°C

For both 5-2 and 7 day options.

To programme the temperature periods, press the set button. Mon will flash. To programme Mondays time/temperature periods press select button. Alternatively use the + and - buttons to change the day, and then select to continue. The time will then flash. This is the start time for the first period. Press + or - to set the hour for the start time for period 1. Press select to move to the minutes. Use the + and - to set the minutes. Press select to set the temperature for this period. Use the + or - keys to set the desired temperature. Press select again to programme the next time period. There are 6 time periods per day.

Once the 6 periods for Monday are programmed, Press set button, and Monday will start to flash. Use the + and - button to change the day to Tuesday, and then use select to program Tuesdays time periods and temperatures. For 7 day programming, this will need to be done for all 7 days. If set is pressed twice, the unit will return to operating mode.

Omitting Days

Omitting a day can be achieved by selecting 10°C for every time period for that day (all times and temperatures must be entered).

The heating will not turn on unless the room temperature falls below 10°C (50°F).

Programming temperature periods for 5-2 days option

For 5-2 day mode, time periods and temperatures will need to be programmed for M-F and then for S-S. ie: only 2 sets of times need to be programmed, not 7 (individual) sets of times.

Temperature override

In operating mode, the temperature set for the current period can be overridden. To adjust the set temperature, press the + or - button once. The screen will illuminate blue while button is pressed. Use + and - buttons to set desired temperature. If the + or - button is held down, the display will advance rapidly. Once the desired temperature is

set, the unit should revert to displaying the current room temperature 5 seconds after the last button press. The illumination will also turn off after 5 seconds. In manual mode, there will be a hand symbol displayed on the screen. The new temperature will remain valid until the next programmed period starts.

A burner symbol  is displayed when temperature is below desired value, indicating that the thermostat is calling for heat from the boiler.

Review set temperature

The set temperature can be reviewed at any time, by a single press of the + or - button. 5 seconds after this single button push, the unit will show the current room temperature, and the screen illumination will turn off.

Frost protection

Frost protection reduces the set temperature to 5°C. Frost protection is activated by holding down the frost protection button for 3 seconds. When in frost mode, the frost symbol  will flash on the display. The set temperature buttons remain non-functional during frost mode. The unit will remain in frost mode until the frost button is held down for a further 3 seconds.

Battery replacement

When the battery needs replacing, a battery symbol  will flash on the display.

Sleep mode

The unit can be put into sleep mode by simultaneously holding down the + and - buttons for 3 seconds. Pressing any button will exit sleep mode. In sleep mode, all outputs are suspended and the screen is blank (useful for longer periods when the house is unoccupied and frost protection is not required).

To clean use a dry cloth only. Do not use any liquid cleaners.

5. Specifications

Current rating:	3 (1) A
Voltage:	230V, 50Hz
Switch type:	Single pole, change-over (SPCO)
Operating temperature range:	0°C to 50°C
Set temperature range:	10°C to 35°C adjustable in 0.5°C steps
Complies with:	BS EN 60730
Conforms to directives:	73-23-EEC, 89-336-EEC
Span:	1°C or 0.5°C
Micro disconnection:	Type 1.B control action
Batteries:	2 x AA alkaline

For assistance with the product please contact:-

HELPLINE

020-8450-0515

or email helpline@timeguard.com



3 Year Guarantee

In the unlikely event of this product becoming faulty due to defective material or manufacture within 3 years of the date of purchase, please return it to your supplier in the first year with proof of purchase and it will be replaced free of charge. For years 2 and 3 or any difficulty in the first year telephone the helpline on **020 8450 0515**.

For a product brochure please contact:

Timeguard Ltd. Victory Park, 400 Edgware Road,
London NW2 6ND Tel: 020-8452-1112
or email csc@timeguard.com

A **thoben** Group company

67-058-328