

	Overview – Supplementary Protectors, UL/CSA – Miniature Circuit Breakers, IEC	9/2
	Single and Multi-Pole Switches, Type <b>FAZ-(B)(C)</b> B and C Trip characteristics	9/4
	Single and Multi-Pole Switches Type <b>FAZ-(D)(S)(R)...</b> D, S and R Trip characteristics	9/5
	Accessories- Auxiliary Contacts, Voltage Trips	9/6
	Wiring Accessories- Feeder Bus Connectors, Terminals	9/7
	Technical Data, Trip Curves, Let-Through Curves	9/10
	Dimensions	9/14
	Fusible and Non-Fusible Disconnect Switches Type <b>P 2-...</b> – Fusible Disconnect Switches, Fuse Blocks – Non-Fusible Disconnect Switches	9/8
	Accessories- Handles, Auxiliary Contacts	9/9
	Technical Data	9/9
	Dimensions	9/14

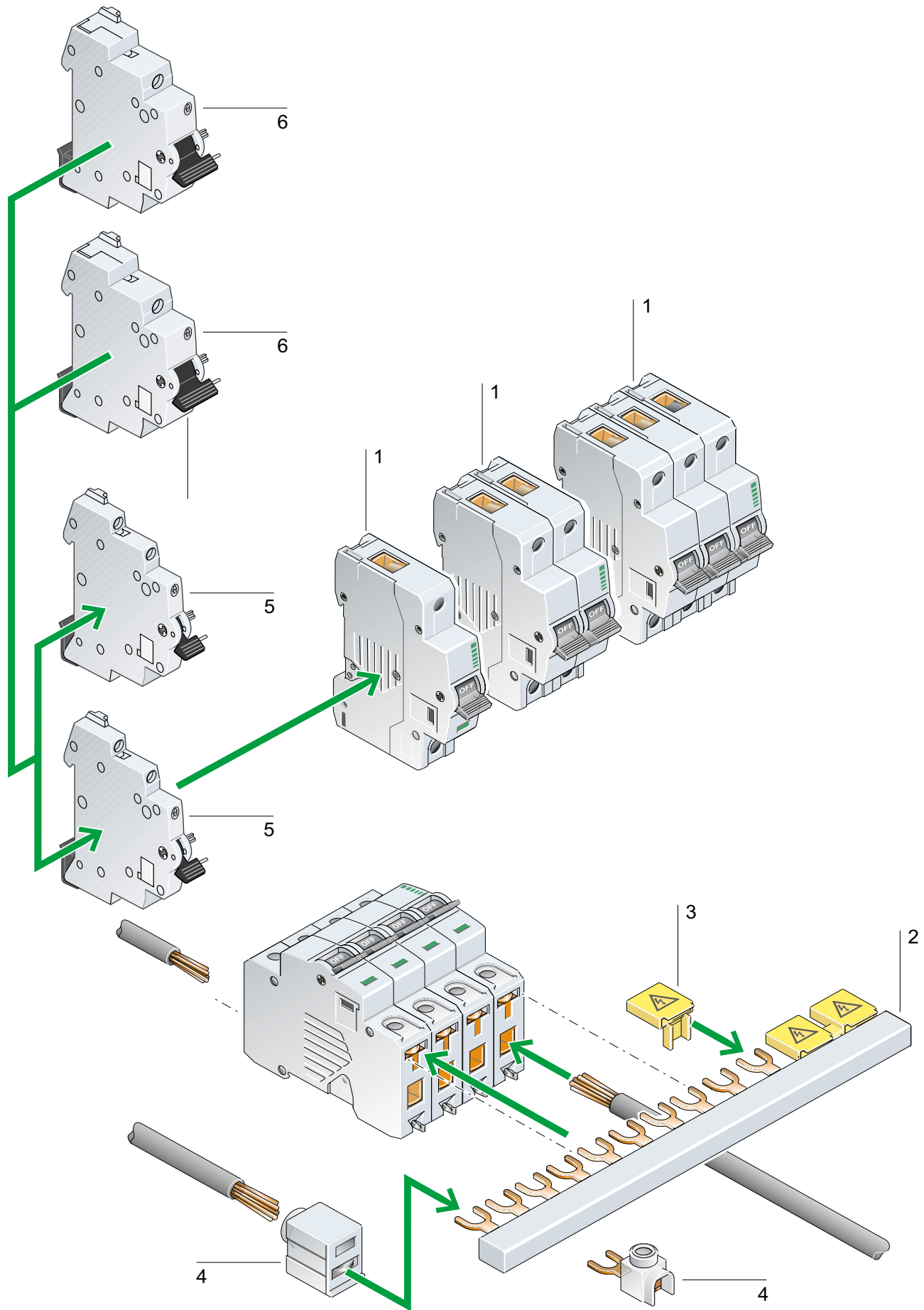

**1 Miniature Circuit Breakers  
Supplementary Protectors**

Available in single or multipole.  
Meets **UL 1077/ CSA 22.2 No. 235**.  
In Conformity with **IEC/EN 60 898**.  
**CE** Marked.  
**B** Trip Characteristic for resistive or slightly inductive loads.  
**C** Trip Characteristic for inductive loads.  
**D\*** Trip Characteristic for highly inductive loads.  
**S\*** Trip Characteristic for protection of control circuits and higher inrush loads.  
**AC** ratings up to 40 A.

\* - UL/CSA pending

**2 Feeder Bus Connectors**

Feeder Bus Connectors for single pole and multipole Supplementary Protectors.  
Will supply from 2 to 12 Supplementary Protector poles.  
Can be joined to accommodate more units.  
Finger-safe design.  
Available for Supplementary Protectors with or without auxiliary contact modules.

**3 Protective Covers**

Slip-on covers for unused terminals on the feeder bus connector to provide protection against shock hazards.

**4 Incoming Supply Terminal**

Accommodates conductor cross-sections up to 35 mm<sup>2</sup>. (~ AWG 2).  
Finger-safe design protects against shock hazards.



**5 Auxiliary Contact Modules**

1 N.O. & 1 N.C. set of contacts  
Field installable or supplied with device.  
Standard Auxiliary Contacts.  
Trip Indicating Auxiliary Contacts.  
Finger-safe design protects against shock hazards.  
Mounts to the side.  
Module width is half the size of a single pole.

**6 Voltage Trips**

Undervoltage Trip  
Shunt Trip  
Field installable or supplied with device.  
Mounts to the side.  
Module width is equal to that of a single pole.

# Miniature Circuit Breakers, FAZ-(B)(C)... Supplementary Protectors, FAZ-(B)(C)...

1	2	3	4	5	6	7	8
Finger-safe Design	Continuous Current Rating (I <sub>n</sub> )	Type 	Price	Type 	Price	Type 	Price
	A	1-pole	\$	2-pole	\$	3-pole	\$
<b>Trip Characteristic "B"</b>	6	FAZ-B6	See Price List	FAZ-2-B6	See Price List	FAZ-3-B6	See Price List
Response Time of Instantaneous Trip: 3...5 x Current Rating In	10	FAZ-B10	See Price List	FAZ-2-B10	See Price List	FAZ-3-B10	See Price List
	13	FAZ-B13	See Price List	FAZ-2-B13	See Price List	FAZ-3-B13	See Price List
	16	FAZ-B16	See Price List	FAZ-2-B16	See Price List	FAZ-3-B16	See Price List
For resistive or slightly inductive loads	20	FAZ-B20	See Price List	FAZ-2-B20	See Price List	FAZ-3-B20	See Price List
	25	FAZ-B25	See Price List	FAZ-2-B25	See Price List	FAZ-3-B25	See Price List
	32	FAZ-B32	See Price List	FAZ-2-B32	See Price List	FAZ-3-B32	See Price List
	40	FAZ-B40	See Price List	FAZ-2-B40	See Price List	FAZ-3-B40	See Price List
<b>Trip Characteristic "C"</b>	0.5	FAZ-C0.5*	See Price List	FAZ-2-C0.5*	See Price List	FAZ-3-C0.5*	See Price List
Response Time of Instantaneous Trip: 5...10 x Current Rating In	1	FAZ-C1*	See Price List	FAZ-2-C1*	See Price List	FAZ-3-C1*	See Price List
	2	FAZ-C2	See Price List	FAZ-2-C2	See Price List	FAZ-3-C2	See Price List
For inductive loads	3	FAZ-C3	See Price List	FAZ-2-C3	See Price List	FAZ-3-C3	See Price List
	4	FAZ-C4	See Price List	FAZ-2-C4	See Price List	FAZ-3-C4	See Price List
	6	FAZ-C6	See Price List	FAZ-2-C6	See Price List	FAZ-3-C6	See Price List
	10	FAZ-C10	See Price List	FAZ-2-C10	See Price List	FAZ-3-C10	See Price List
	13	FAZ-C13	See Price List	FAZ-2-C13	See Price List	FAZ-3-C13	See Price List
	16	FAZ-C16	See Price List	FAZ-2-C16	See Price List	FAZ-3-C16	See Price List
	20	FAZ-C20	See Price List	FAZ-2-C20	See Price List	FAZ-3-C20	See Price List
	25	FAZ-C25	See Price List	FAZ-2-C25	See Price List	FAZ-3-C25	See Price List
	32	FAZ-C32	See Price List	FAZ-2-C32	See Price List	FAZ-3-C32	See Price List
	40	FAZ-C40	See Price List	FAZ-2-C40	See Price List	FAZ-3-C40	See Price List

\* - UL/CSA pending

Type **FAZ-...** components are single pole and multi-pole thermal-magnetic protective devices which can be used both internationally and domestically.

Internationally, **FAZ-B...**, **FAZ-C...** and **FAZ-D** switches are in conformity with the product standard **IEC/EN 60 898** and are referred to and applied commonly as **Miniature Circuit Breakers** in electrical circuits.



**FAZ-S...** switches are specifically geared towards the protection of control circuits and other more inductive loads. Their tripping characteristic is in conformity with **IEC/EN 60 947-2** (Circuit Breakers).

Consult Moeller Electric for further information on the broader range of devices available conforming to IEC standards.

Domestically, **FAZ-B...** and **FAZ-C...** switches are **UL recognized and CSA certified as Supplementary Protectors**. Per the intent of **NEC** (National Electrical Code) **Article 240**, Supplementary Protectors **cannot be** used as a substitute for the branch circuit protective device. They can be used to provide overcurrent protection within an appliance or other electrical equipment where branch circuit overcurrent protection is already provided, or is not required.

**Ordering Information:** Specify Type from columns 3, 5 and 7  
Example: **FAZ-C16**

# Miniature Circuit Breakers, FAZ-(D)(S)(R)... Supplementary Protectors, FAZ-(D)(S)(R)...<sup>1)</sup>

1	2	3	4	5	6	7	8
Finger-safe Design	Continuous Current Rating (I <sub>n</sub> )	Type	Price	Type	Price	Type	Price
	A	 <b>1-pole</b>	\$	 <b>2-pole</b>	\$	 <b>3-pole</b>	\$
<b>Trip Characteristic "D"</b>	6	<b>FAZ-D6</b>	See Price List	<b>FAZ-2-D6</b>	See Price List	<b>FAZ-3-D6</b>	See Price List
Response Time of Instantaneous Trip:	10	<b>FAZ-D10</b>	See Price List	<b>FAZ-2-D10</b>	See Price List	<b>FAZ-3-D10</b>	See Price List
10 – 20 x Current Rating I <sub>n</sub>	13	<b>FAZ-D13</b>	See Price List	<b>FAZ-2-D13</b>	See Price List	<b>FAZ-3-D13</b>	See Price List
For highly inductive loads	16	<b>FAZ-D16</b>	See Price List	<b>FAZ-2-D16</b>	See Price List	<b>FAZ-3-D16</b>	See Price List
	20	<b>FAZ-D20</b>	See Price List	<b>FAZ-2-D20</b>	See Price List	<b>FAZ-3-D20</b>	See Price List
	25	<b>FAZ-D25</b>	See Price List	<b>FAZ-2-D25</b>	See Price List	<b>FAZ-3-D25</b>	See Price List
CE	32	<b>FAZ-D32</b>	See Price List	<b>FAZ-2-D32</b>	See Price List	<b>FAZ-3-D32</b>	See Price List
	40	<b>FAZ-D40</b>	See Price List	<b>FAZ-2-D40</b>	See Price List	<b>FAZ-3-D40</b>	See Price List
<b>Trip Characteristic "S"</b>	1	<b>FAZ-S1</b>	See Price List	<b>FAZ-2-S1</b>	See Price List	—	See Price List
Response Time of Instantaneous Trip:	2	<b>FAZ-S2</b>	See Price List	<b>FAZ-2-S2</b>	See Price List	—	See Price List
13 – 17 x Current Rating I <sub>n</sub>	3	<b>FAZ-S3</b>	See Price List	<b>FAZ-2-S3</b>	See Price List	—	See Price List
For protection of control circuits and highly inductive loads	4	<b>FAZ-S4</b>	See Price List	<b>FAZ-2-S4</b>	See Price List	—	See Price List
	6	<b>FAZ-S6</b>	See Price List	<b>FAZ--2-S6</b>	See Price List	—	See Price List
UL, CSA, CE	10	<b>FAZ-S10</b>	See Price List	<b>FAZ-2-S10</b>	See Price List	—	See Price List
	16	<b>FAZ-S16</b>	See Price List	<b>FAZ--2-S16</b>	See Price List	—	See Price List
<b>Trip Characteristic "R"</b>	6	<b>FAZ-R6</b>	See Price List	<b>FAZ-2-R6</b>	See Price List	<b>FAZ-3-R6</b>	See Price List
Response Time of Instantaneous Trip:	10	<b>FAZ-R10</b>	See Price List	<b>FAZ-2-R10</b>	See Price List	<b>FAZ-3-R10</b>	See Price List
2 – 3 x Current Rating I <sub>n</sub>	13	<b>FAZ-R13</b>	See Price List	<b>FAZ-2-R13</b>	See Price List	<b>FAZ-3-R13</b>	See Price List
For circuits where a low instantaneous trip response is desired.	16	<b>FAZ-R16</b>	See Price List	<b>FAZ-2-R16</b>	See Price List	<b>FAZ-3-R16</b>	See Price List
	20	<b>FAZ-R20</b>	See Price List	<b>FAZ-2-R20</b>	See Price List	<b>FAZ-3-R20</b>	See Price List
	25	<b>FAZ-R25</b>	See Price List	<b>FAZ-2-R25</b>	See Price List	<b>FAZ-3-R25</b>	See Price List
UL, CSA, CE	32	<b>FAZ-R32</b>	See Price List	<b>FAZ-2-R32</b>	See Price List	<b>FAZ-3-R32</b>	See Price List
	40	<b>FAZ-R40</b>	See Price List	<b>FAZ-2-R40</b>	See Price List	<b>FAZ-3-R40</b>	See Price List

1) **FAZ-D...** devices are pending UL and CSA approval as Supplementary Protectors.

Type **FAZ...** components are single pole and multi-pole thermal-magnetic protective devices which can be used both internationally and domestically.

Internationally, **FAZ-D...** switches are in conformity with the product standard **IEC/EN 60 898** and are referred to and applied commonly as **Miniature Circuit Breakers** in electrical circuits. The tripping characteristics of the **FAZ-S...** and **FAZ-R...** devices are in conformity with IEC/EN 60 947-2 (Circuit Breakers). Consult Moeller Electric for further information on the broader range of devices available conforming to IEC standards.

Domestically, **FAZ-S...** and **FAZ-R...** switches are UL recognized and CSA certified as Supplementary Protectors (UL 1077/CSA 22.2 No.235). Per the intent of NEC (National Electric Code) Article 240, Supplementary Protectors cannot be used as a substitute for the branch circuit protective device. They can be used to provide overcurrent protection within an appliance or other electrical equipment where branch circuit overcurrent protection is already provided, or is not required.

Note: The 1/2 and 1 amp size **FAZ-C...** switches are now UL/CSA (See page 9/4)

**Ordering Information:** Specify Type from columns 3, 5 and 7  
Example: **FAZ-D16**

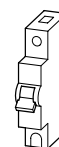

**1-pole**  
Depth 71 mm  
Width 17.5 mm

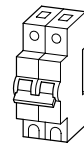

**2-pole**  
Depth 71 mm  
Width 35 mm

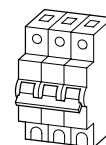

**3-pole**  
Depth 71 mm  
Width 52.5 mm

# Accessories for Supplementary Protectors/Miniature Circuit Breakers

## Auxiliary Contacts, Voltage Trips

1	2	3	4	5	6
	Contact diagram	Contacts	Width, relative to a single pole switch (1 pole=18 mm)	Type	Price
		N.O. N.C.			\$

### Auxiliary Contacts

#### Standard Auxiliary Contacts

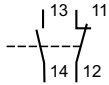

1 1

IEC/EN 60 947  
Auxiliary Contact  
Rating

AC 13  
6 A @ 250 V AC

1/2

FAZ/FIP-XHI11

See Price List See Price List See Price List See Price List See Price List See Price List

#### Trip Indicating Auxiliary Contacts

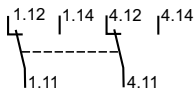

2 Form C  
Contacts

AC 15  
1 A @ 230 V AC

1/2

FAZ/FIP-XRHI002

### Voltage Trips

#### Undervoltage Trip

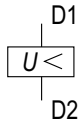

Voltage Rating:

115 V AC

1

FAZ-XUA(115VAC)

230 V AC

1

FAZ-XUA(230VAC)

#### Shunt Trip

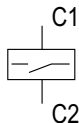

AC 110 - 415 V  
DC 110 - 230 V

1

FAZ-XAA(110-415VAC)

DC 12 - 60 V  
AC 12 - 110 V

1



FAZ-XAA(12-110VAC)

Ordering Information: Specify Type from column 5  
Example: FAZ-XUA(230VAC)

Miniature Circuit Breakers, Supplementary Protectors  
Disconnect Switches

9

## Supplementary Protectors/Miniature Circuit Breakers Accessories

1	2	3	4	5	6	7	8	9	10
	Number of Poles	Max. rated current	Number of terminals <b>without</b> auxiliary contact spacing	Width of Connector mm	Type (without auxiliary contact spacing)	Number of terminals <b>with</b> auxiliary contact spacing	Width of Connector mm	Type (with auxiliary contact spacing)	Price \$
<b>Feeder Bus Connectors</b>									
<i>Fork terminals</i>									
	1-pole	85	2	30	FAZ-XIS1/2	2	53	FAZ-XIS1/2-HI	See Price List
		85	6	104	FAZ-XIS1/6	6	155	FAZ-XIS1/6-HI	
		85	12	207	FAZ-XIS1/12	9	228	FAZ-XIS1/9-HI	
	2-pole	120	4	65	FAZ-XIS2/4	4	73	FAZ-XIS2/4-HI	See Price List
		120	6	104	FAZ-XIS2/6	6	120	FAZ-XIS2/6-HI	
		120	12	207	FAZ-XIS2/12	10	207	FAZ-XIS2/10-HI	
	3-pole	120	6	104	FAZ-XIS3/6	6	120	FAZ-XIS3/6-HI	See Price List
		120	12	207	FAZ-XIS3/12	12	236	FAZ-XIS3/12-HI	
		120	—	—	—	6	155	FAZ-XIS31/6-HI <sup>1)</sup>	
		120	—	—	—	8	207	FAZ-XIS31/8-HI <sup>1)</sup>	
		120	—	—	—	9	236	FAZ-XIS31/9-HI <sup>1)</sup>	

### Incoming Supply Terminals for Bus Connectors

For Conductors up to 25 mm<sup>2</sup> (~AWG 4)  
Finger Safe Connection

Fork connector



FAZ-XK25

For Conductors up to 35 mm<sup>2</sup> (~AWG 2)  
Finger Safe Connection to **FAZ-XIS**  
Bus Connector



FAZ-XK35

For covering non-utilized terminals



FAZ-XBS

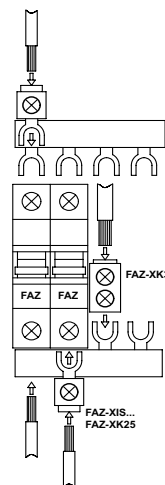

1) 1 auxiliary contact per pole

**Ordering Information:** Specify Type from Columns 6 and 9

See Price List See Price List See Price List See Price List See Price List See Price List See Price List See Price List See Price List See Price List

Miniature Circuit Breakers, Supplementary Protectors  
Disconnect Switches

1	2				3	4	5								6	7	8	9	10	11	12
Con- tinuous Current Rating	3 Phase Maximum HP rating 50 - 60 Hz				Type Complete type with suffixes from columns 5, 7, 9 or 11	Max. fuse clip  A	With fuse base and clips <sup>1)</sup> for:														
							Class H fuses				Class H or J fuses				Class R fuses						
	200 V		230 V				460 V		575 V		250 V		600 V		250 V		600 V				
A	Type suffix	Price \$	Type suffix	Price \$	Type suffix	Price \$	Type suffix	Price \$	Type suffix	Price \$	Type suffix	Price \$	Type suffix	Price \$	Type suffix	Price \$	Type suffix	Price \$			
30	7 1/2	10	20	25	P 2-30/F-...	30	C 13-CNA	See Price List	C 23-CNA <sup>2)</sup>	See Price List	C 33-CNA	See Price List	C 36-CNA	See Price List							
						60	C 16-CNA	See Price List	C 26-CNA	See Price List	C 43-CNA	See Price List	C 46-CNA	See Price List							
60	15	20	40	50	P 2-60/F-...	60	C 16-CNA	See Price List	C 26-CNA	See Price List	C 43-CNA	See Price List	C 46-CNA	See Price List							
						100	C 110-CNA	See Price List	C 110-CNA	See Price List	C 310-CNA	See Price List	C 310-CNA	See Price List							
100	30	40	60	75	P 2-100/F-...	100	C 110-CNA	See Price List	C 110-CNA	See Price List	C 310-CNA	See Price List	C 310-CNA	See Price List							

**Ordering information**  
Specify: **Type** from column 3 + **Type suffixes** from columns 5, 7, 9, or 11  
Example: **P2-60/F-C 310-CNA**

- Standard Features**
- Visible quick make, quick break contacts
  - Line terminal shield
  - Fusible switches include non-interchangeable fuse clips
  - UL Recognized, CSA Certified

## Fuse Blocks - Type F<sup>3)</sup>

1	2		3	4		5	6
Ampere Rating	With fuse holders for Non-time Delay Fuses or Dual element (Time Delay Fuses) "H" dimensions		With fuse holders for Class "J" fuses "J" dimensions	With fuse holders for Class "R" fuses		Type	Price
A	250 V	600 V	to 600 V	250 V	600 V		\$
30	30	—	—	—	—	F 30-C 13-CNA	See Price List
	—	30	—	—	—	F 30-C 38-CNA	See Price List
	—	—	30	—	—	F 30-C 23-CNA	See Price List
	—	—	—	30	—	F 30-C 33-CNA	See Price List
	—	—	—	—	30	F 30-C 36-CNA	See Price List
60	60	—	—	—	—	F 60/100-C 16-CNA	See Price List
	—	60	60	—	—	F 60/100-C 26-CNA	See Price List
	—	—	—	60	—	F 60/100-C 43-CNA	See Price List
	—	—	—	—	60	F 60/100-C 46-CNA	See Price List
100	100	100	100	—	—	F 60/100-C 110-CNA	See Price List
	—	—	—	100	100	F 60/100-C 310-CNA	See Price List

- 1) Complete **Type** includes fuse holders, but not fuses or operating handle. Refer to opposite page for handle selection.
- 2) Type **C 23-CNA** for Class J fuses only. For Class H fuses, specify Type **C 38-CNA** as a substitute.
- 3) Fuses not included.

### Ordering information

Specify: **Type** number from column 5. Fuseblocks come complete with fuse clips & terminals. Fuses not included.  
Example: **F 30-C 23-CNA** (Good for 30 A, 600 V J fuses)



1		2		3		4		5	
Non-Fusible Disconnect Switches - Open Type									
Continuous Current	50 - 60 Hz				Type	Price		Remarks	
A	200 V HP	230 V HP	460 V HP	575 V HP		\$			
30	7 1/2	10	20	30	P 2-30-CNA	See Price List	See Price List	Operating handles not included. See below. For Molded Case Switches up to 600 A, refer to Section 8.	
60	15	20	40	50	P 2-60-CNA	See Price List	See Price List		
100	30	40	60	75	P 2-100-CNA	See Price List	See Price List		

**Rotary Action Operating Handles for P 2-... Fusible and Non-Fusible Disconnect Switches**

For manual operation with door open. No cover interlock	H6U	See Price List	See Price List	H6U and H6-SW-NA handles are accessories from the NZM Molded Case Circuit Breaker product line. Refer to Section 8 for further information.
Door mounted with cover interlock and padlock feature. Color, black	H6-SW-NA	See Price List	See Price List	

**Auxiliary Contacts**

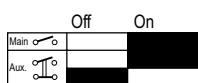

- Contact open
- Contact closed
- Easy bolt on installation
- visible contacts
- 2 N.O. 2 N.C.

HI 22-P2-NA

See Price List  
See Price List

Ordering Information: Specify Type from Column 3. Example: P2-60-CNA

**Technical Data**

General				Type P2-30 P2-30/F...	Type P2-60 P2-60/F...	Type P2-100 P2-100/F...
<b>Main Contacts</b>						
Rated Voltage		V AC	600	600	600	600
Rated Continuous Current		A	30	60	100	100
Short Circuit Current Rating						
	Non-Fusible Switch	kA RMS Sym	10	10	10	10
	With Class J, R fuses	kA RMS Sym	100	100	100	100
Maximum AC Motor HP Rating-3 Phase at:	200 V	HP	7 1/2	15	30	30
	230 V	HP	10	20	40	40
	460 V	HP	20	40	60	60
	575 V	HP	25	50	75	75
Dimensions (See Page 9/14)						
AWG... Conductor Cross-Section (Cu only)	Minimum		14	10	10	10
	Maximum		6	1/0	1/0	1/0
<b>Auxiliary Contacts</b>		Pilot Duty Rating	Heavy Duty, A 600/P 600			



Tripping Characteristics

Tripping characteristics: B/C/D to IEC/EN 60 898

Tripping characteristics: S to IEC/EN 60 947

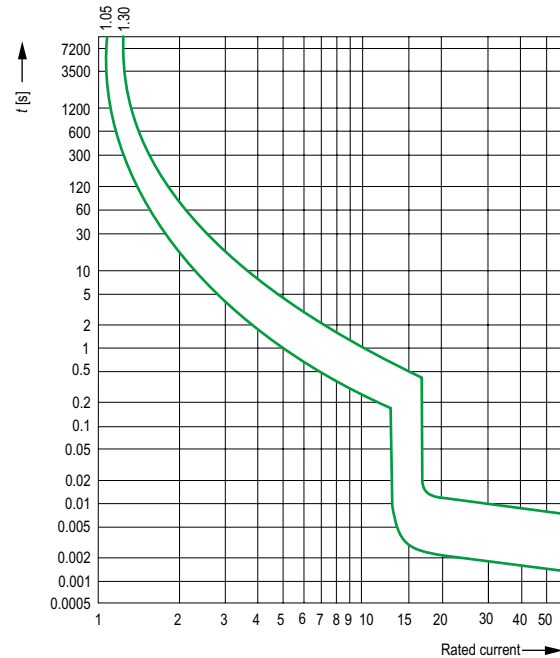
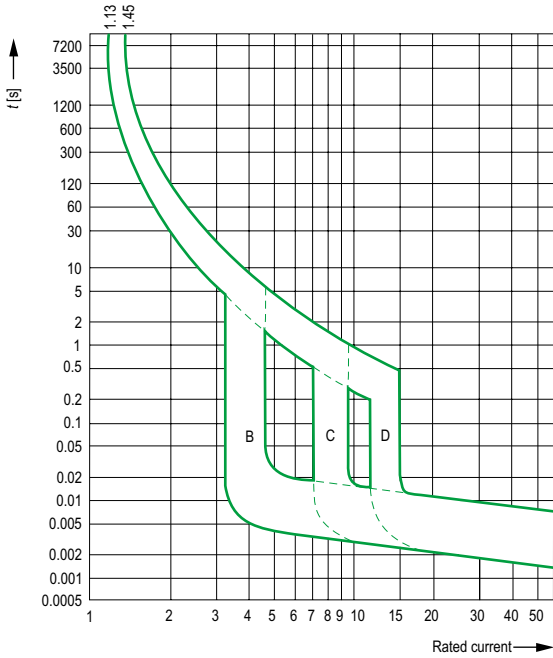

Let-through energy  $I^2t$ /let-through current  $\hat{I}_D$  Curves

Let-through energy  $I^2t$  FAZ(B)(C)

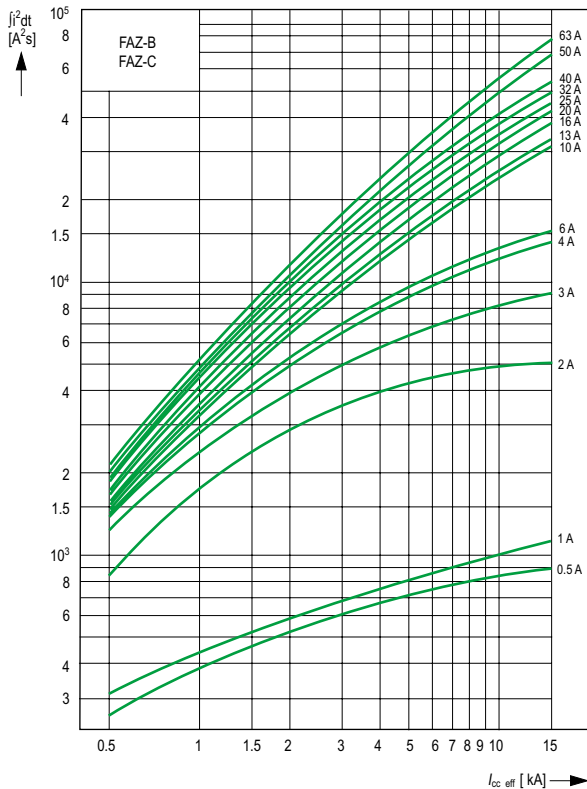

Let-through Current  $\hat{I}_D$  FAZ(B)(C)

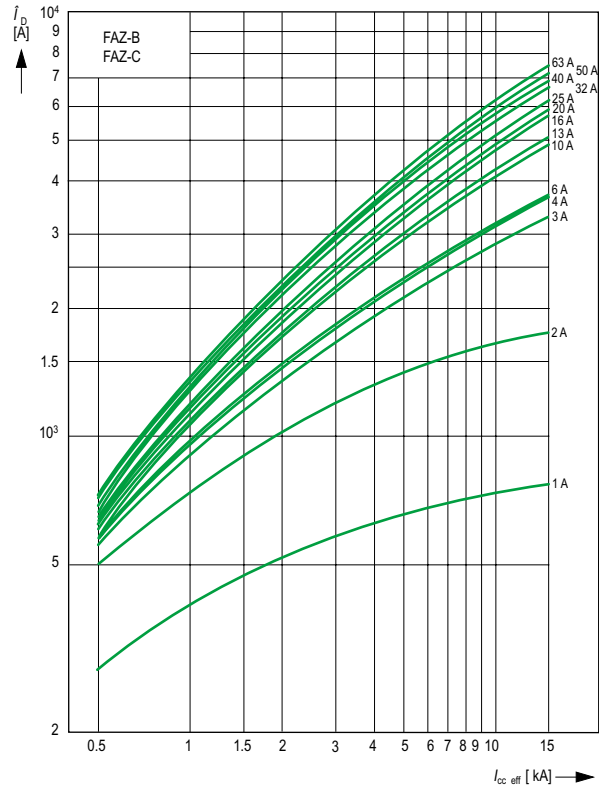

Miniature Circuit Breakers, Supplementary Protectors, Disconnect Switches

9

Let-through energy  $I^2t$ /let-through current  $\hat{I}_D$  Curves

Let-through energy  $I^2t$  FAZ(D)

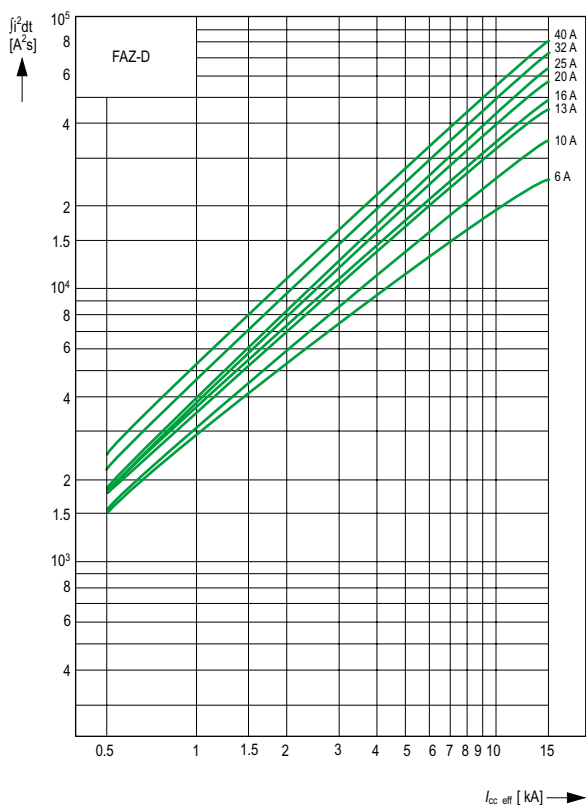

Let-through Current  $\hat{I}_D$  FAZ(D)

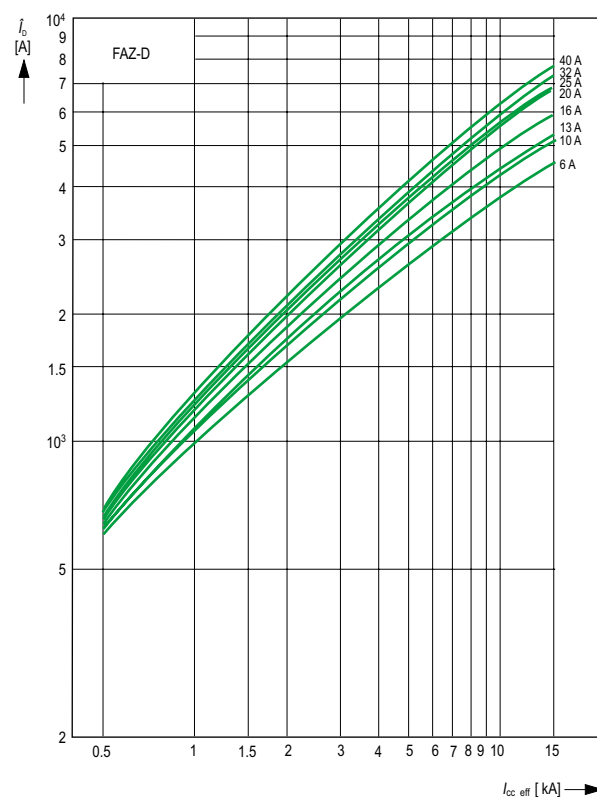

# UL/CSA- Supplementary Protectors/ IEC- Miniature Circuit Breakers

## Technical Data

				FAZ
<b>General</b>				
IEC Standards <b>B, C, D</b> Characteristics <b>S</b> Characteristic				IEC/EN 60 898, VDE 0641, DIN43 880 IEC/EN 60 947-2, VDE 0660 Part 1, DIN 43 880
UL/CSA Standards				UL 1077, CSA 22.2 No. 235
Ambient temperature	Min./max.	°C		-5/+40
Influence of ambient temperature on rated current (Ref. 30 °C)		% / K		Consult Moeller Electric
Mechanical shock resistance (shock duration 20 ms)		g		10
Mounting position				Optional, as required
Direction of incoming supply				Optional, as required
Protection against electric shock				Finger and back of hand safe
Degree of protection (field-wiring terminals)				IP 20 (IP 00)
Dimensions				See page 9/14
Weight per pole	kg			0.12
Terminal capacity, IEC Solid, stranded	Min./max.	mm <sup>2</sup>		1/25; 2 x 1/4 <sup>1)</sup>
Tightening torque, IEC wire		Nm		2.4
Terminal capacity, UL/CSA	Min./max.	AWG		18...8, Cu only 75 °C
Tightening torque, UL/CSA wire		Nm		2.4
Rated current I <sub>n</sub> = Rated uninterrupted current I <sub>v</sub>		A		2...40 (UL/CSA), 0.5...63 (IEC)
Rated impulse withstand voltage U <sub>imp</sub>		V		4000
Rated insulation voltage U <sub>i</sub>		V AC		440
Pollution degree/overvoltage category		AC		III/3
IEC Rated operational voltage U <sub>e</sub>		V AC		230/400; 240/415
UL/CSA Rated Voltage	Single pole/Multi-Pole DC	V AC V DC		277/480 40
Rated frequency		Hz		50/60
<b>Switching capacity, IEC/EN 60 898/ VDE 0641</b>				
<b>@ 230/ 400 V AC</b>	FAZ(B)(C)(D)	kA		10
<b>Switching capacity, IEC/EN 60 947-2</b>				
<b>@ 230/ 400 V AC</b>	FAZ(S)	kA		4.5
<b>Short Circuit Current Rating, UL 1077/CSA 22.2 No. 235</b>				
<b>@ 277/ 480 V AC</b>	FAZ(B)(C)	1-pole kA		5
	FAZ(B)(C)	Multi-Pole kA		5
<b>Mechanical Lifespan</b> (1 operation = 2 switching movements)		# of Operations		7,000

1) When using 2 wires, use same cross-section

Auxiliary Contacts, Voltage Trips				FAZ/FIP-XHI11 Std. Auxiliary Contacts FAZ/FIP-XRHI002 Trip Indicating Contacts	FAZ-XUA U trip	FAZ-XAA Shunt Trip
<b>General</b>						
Degree of protection (field-wiring terminals)				IP 20 (IP 00)	IP 20 (IP 00)	IP 20 (IP 00)
Dimensions				See page 9/14	See page 9/14	See page 9/14
Weight kg				0.045	0.155	0.155
Terminal Capacity, IEC						
Solid		Min./Max.	mm <sup>2</sup>	0.5/4; 2 x 0.5/2.5	0.5/4; 2 x 0.5/2.5	0.5/4; 2 x 0.5/2.5
Tightening Torque, IEC wire				Nm	0.8	1.5
Terminal Capacity, UL/CSA				Min./Max.	AWG	18...14, Cu, 75 °C
Tightening Torque, UL/CSA wire				Nm	0.8	1.5
<b>Auxiliary Contacts</b>						
Maximum operating current, IEC/EN 60 947						
XHI		AC13 @ 250 V AC	A	6	—	—
XRHI		AC15 @ 230 V AC	A	1	—	—
Mechanical Lifespan Operations				6,000	10,000	4,000
<b>Voltage Trips</b>						
Minimum Impulse Duration				ms	—	> 15
Minimum Command Time				ms	—	—
Operating Voltage						
FAZ-XUA			V AC	—	115/230	—
FAZ-XAA (type 1)			V AC	—	—	—
			V DC	—	—	110 – 415 110 – 230
FAZ-XAA (type 2)			V AC	—	—	—
			V DC	—	—	12 – 110 24 – 60
Undervoltage Trip Coil						
FAZ-XUA(AC)						
Drop-out			x U <sub>s</sub>	—	0.7... 0.35	—
Inrush current			A(AC/DC)	—	3.6/44	—
Shunt Trip Coil						
FAZ-XAA						
Voltage range			x U <sub>s</sub>	—	—	—
Inrush current			A (AC)	—	—	0.7...1.1
			A (DC)	—	—	25/12 ms 15/3 ms

U<sub>s</sub> = Rated Coil Voltage

**Hints for mounting Auxiliary Contacts and Voltage Trips to FAZ Supplementary Protectors**

Maximum Combination Possibilities				
FAZ/FIP-XHI11	FAZ/FIP-XRHI002	FAZ-XAA	FAZ-XUA	
●	—	●	—	●
—	●	●	—	●
—	—	—	●	●

**Load reduction factors for adjoining FAZ Supplementary protectors**

Correction factor k, to be applied when FAZ supplementary protectors are mounted side by side at rated load (I<sub>n</sub>).

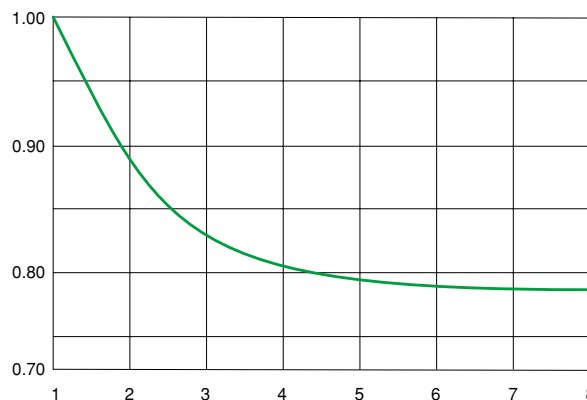

# UL/CSA Supplementary Protectors/ IEC Miniature Circuit Breakers Dimensions

## Supplementary Protectors/ Miniature Circuit Breakers

FAZ-B  
FAZ-C  
FAZ-D  
FAZ-S

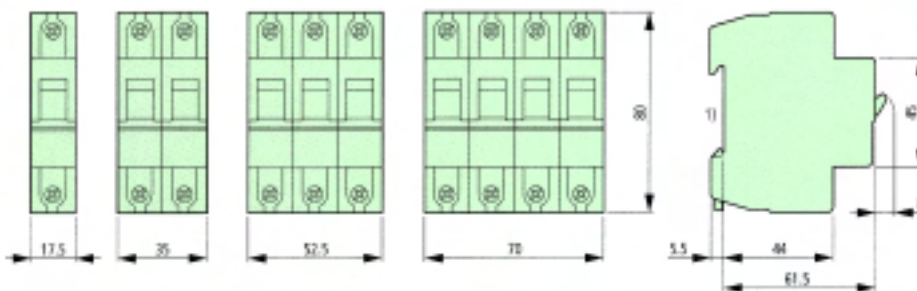

## Accessories

FAZ/FIP-XHI11

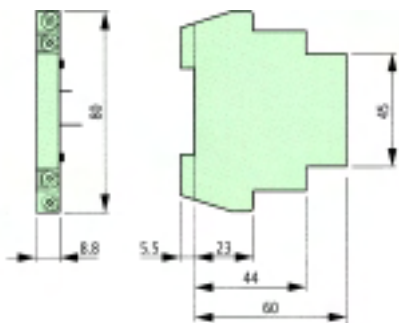

FAZ/FIP-XRHI002

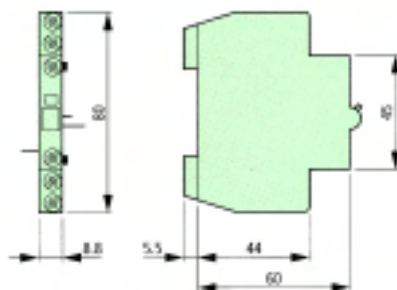

FAZ-XUA



FAZ-XAA

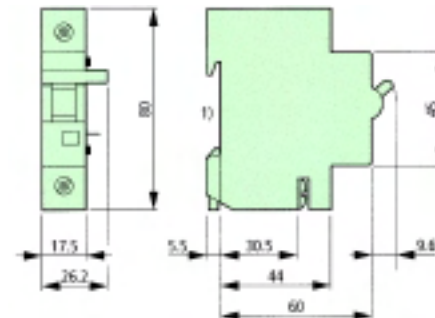

## Feeder Bus Connectors

FAZ-XIS

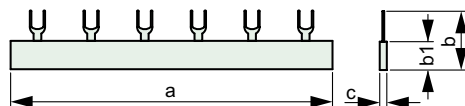

### Connectors without auxiliary contact spacing

Type	a	b	b1	c
FAZ-XIS1/2	30	29	14	3.5
FAZ-XIS1/6	104	29	14	3.5
FAZ-XIS1/12	207	29	14	3.5
FAZ-XIS2/4	65	29	14	6.3
FAZ-XIS2/6	104	29	14	6.3
FAZ-XIS2/12	207	29	14	6.3
FAZ-XIS3/6	104	29	14	9.0
FAZ-XIS3/12	206	29	14	9.0

### Connectors with auxiliary contact spacing

Type	a	b	b1	c
FAZ-XIS1/2-HI	53	29	14	3.5
FAZ-XIS1/6-HI	155	29	14	3.5
FAZ-XIS1/9-HI	228	29	14	3.5
FAZ-XIS2/4-HI	73	29	14	6.3
FAZ-XIS2/6-HI	120	29	14	6.3
FAZ-XIS2/10-HI	207	29	14	6.3
FAZ-XIS3/6-HI	120	29	14	10.7
FAZ-XIS3/12-HI	236	29	14	10.7
FAZ-XIS31/6-HI	155	29	14	10.7
FAZ-XIS31/8-HI	207	29	14	10.7
FAZ-XIS31/9-HI	236	29	14	10.7

1) Standard 35 mm DIN rail per EN 50022

## Fusible Disconnect Switch

P 2-30(60)/F-...-CNA  
P 2-100/F-...-CNA

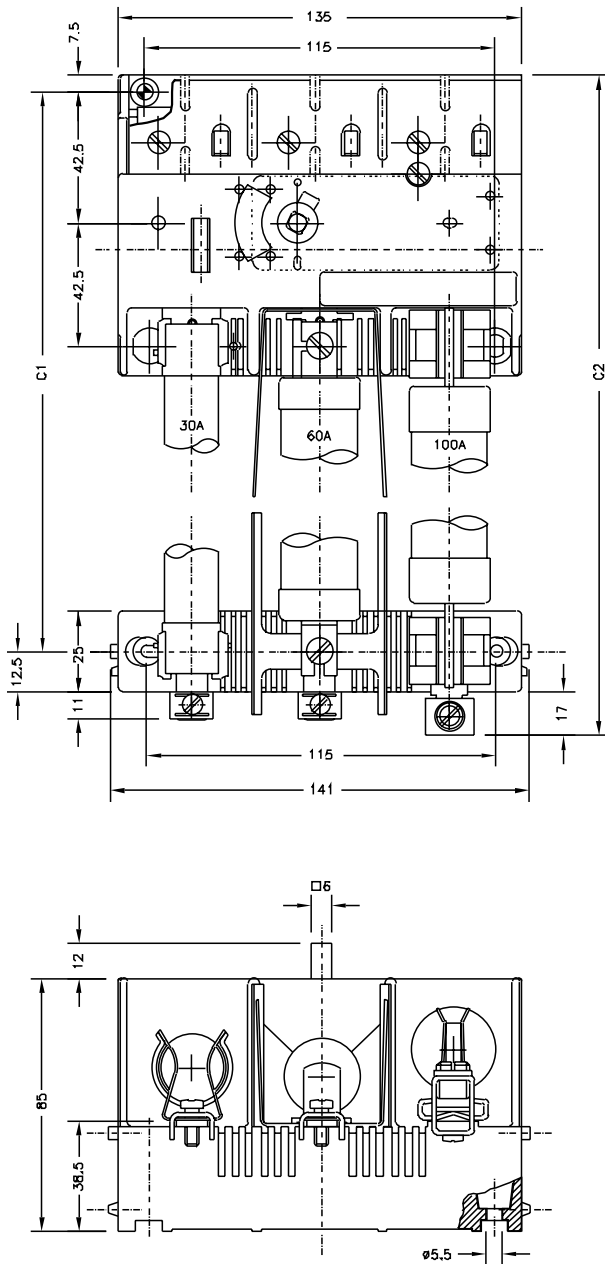

## Fuseblocks

F-...-CNA

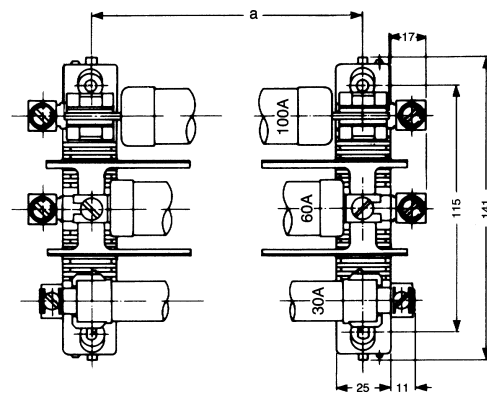

Fuse Class	Fuse Rating		Dimensions in millimeters	
	V	A	C1	C2
H and (R)K	250	30	122	153
		60	144	181
		100	208	245
	600	30	198	229
		60	208	245
		100	259	296
J	600	30	128	159
		60	130	167
		100	176	213

Fuse Block Type	Fuse Rating		Dimensions		
	A	V	H	J	R
F 30-C13-CNA	30	250	1 1/2 in. (38 mm)	1 3/4 in. (45 mm)	1 1/2 in. (38 mm) 4 1/2 in. (114 mm)
F 30-C38-CNA	30	600	4 1/2 in. (114 mm)		
F 30-C23-CNA	30	600			
F 30-C33-CNA	30	250			
F 30-C36-CNA	30	600			
F 60/100-C16-CNA	60	250	2 3/8 in. (60 mm)	1 3/4 in. (45 mm)	2 3/8 in. (60 mm) 4 7/8 in. (124 mm)
F 60/100-C26-CNA	60	600	4 7/8 in. (124 mm)		
F 60/100-C43-CNA	60	250			
F 60/100-C46-CNA	60	600			
F 60/100-C110-CNA	100	250	4 7/8 in. (124 mm)	3 5/8 in. (92 mm)	4 7/8 in. (124 mm) 6 7/8 in. (175 mm)
F 60/100-C110-CNA	100	600	6 7/8 in. (175 mm)		
F 60/100-C310-CNA	100	250			
F 60/100-C310-CNA	100	600			

