

## TLK110 Customer EVM

This user's guide details the design and operation of the evaluation module (EVM) for the TLK110.

### Contents

1	TLK110 EVM Purpose and Content .....	1
2	Information and Specifications .....	2
2.1	Usage Setup and Configuration .....	2
2.2	Address Settings .....	2
2.3	TLK110CUSEVM Connections .....	2
3	TLK110CUSEVM Specification .....	3
3.1	Overview .....	3
3.2	Required Resources .....	3
3.3	Features .....	3
3.4	TLK110CUSEVM Block Diagram .....	4
3.5	PCB Physical Layout .....	5
3.6	EVM Schematics .....	6
3.7	Bill of Materials .....	12
4	Software .....	15

### List of Figures

1	EVM Block Diagram .....	4
2	EVM Layout.....	5
3	TLK110CUSEVM Top Level Schematics .....	6
4	TLK110CUSEVM / TLK110 Schematics.....	7
5	TLK110CUSEVM 3.3V/1.5V LDO Schematics.....	8
6	TLK110CUSEVM / SOR Schematics .....	9
7	TLK110CUSEVM / MII Connector Schematics.....	10
8	TLK110CUSEVM / Magnetics Schematics.....	11

### List of Tables

1	TLK110CUSEVM Connections.....	2
2	TLK110CUSEVM Aneg Modes Connections.....	2
3	Bill of Materials.....	12

## 1 TLK110 EVM Purpose and Content

The purpose of the Industrial Ethernet TLK110CUSEVM is to provide Texas Instruments customers a platform to quickly design and market systems containing the TLK110 device. Customers are encouraged to copy EVM components to expedite their design process. The TLK110CUSEVM operates with only a single voltage (5V from the MII). All other voltages are internally produced.

The EVM kit contains:

- TLK110CUSEVM unit
- Printed copy of this user's guide
- TLK110CUSEVM schematic

## 2 Information and Specifications

This section contains the specifications of the TLK110CUSEVM card, as well as a description of the card's interfaces, connectors, jumpers, and LEDs.

### 2.1 Usage Setup and Configuration

Power for the TLK110CUSEVM is supplied via a MII connector.

- If 5V is supplied, the on-board voltage regulator, U1, will convert 5V to 3.3V for the device.
- If 3.3V is supplied from the MII connector, R59 should be assembled and R56 should be removed.
- Make sure the J2 jumper is installed in order to supply 3.3V to the magnetic CT.
- Make sure J1 jumper is installed and configured to MII or RMII.

### 2.2 Address Settings

The PMD address TLK110CUSEVM Physical Layer device is set by the following jumpers:

- J7: PHY ID [0]
- J6: PHY ID [1]
- J5: PHY ID [2]

**The default board setting for the PHY address is 01h.** The board may be set to any PHY address 00h - 07h by adding jumpers J5 - J7.

### 2.3 TLK110CUSEVM Connections

Table 1 describes the connections of the TLK110CUSEVM.

**Table 1. TLK110CUSEVM Connections**

Jumper	Name	Function
P1	MII male connector	MII interface
J1	MII or RMII selector	Select between MII mode or RMII mode
J14	RESET N	Reset the device
J2	Central tap voltage selector	Enable 3.3V supply to the central tap
U2	RJ45	RJ45 ethernet connector
J5 - J7	PHY ID[0:2]	Configure PHY ID address (default = addr 01h)
J15 (Not populated)	25M out	25M clock output
J10	RMII enable	Enable RMII (default = MII)
J8	CFG CROSSOVER	Disable AMDIX (default = AMDIX ON)
J3	CFG ANEG MODE	See description below
J4	AFG ANEG SPD 0	See description below
J5	AFG ANEG SPD 1	See description below

**Table 2. TLK110CUSEVM Aneg Modes Connections**

AN-EN	AN_1	AN_0	Forced Mode
0	0	0	10BT, Half duplex
0	0	1	10BT, Full duplex
0	1	0	100BT, Half duplex
0	1	1	100BT, Full duplex
AN-EN	AN_1	AN_0	Advertised Mode
1	0	0	10BT, Half/Full duplex
1	0	1	100BT, Half/Full duplex
1	1	0	10BT, 100BT, Half duplex
1	1	1	10BT, 100BT, Full duplex

## 3 TLK110CUSEVM Specification

### 3.1 Overview

The TLK110CUSEVM is a Texas Instruments platform that allows a customer to evaluate the TLK110 device and demonstrate the advanced features specified in the TLK110 datasheet.

The EVM supports 10/100 Base-T and is IEEE 802.3 standard compliant.

The TLK110CUSEVM operates with a single supply (5V or 3.3V) from the MII. All other voltages required for the TLK110 are internally generated in the device.

The TLK110CUSEVM is designed to work in industrial temperatures.

### 3.2 Required Resources

Any equipment that provides a standard IEEE 802.3, Clause 22 MII DTE interface; e.g. SmartBits/Netcom box.

### 3.3 Features

The TLK110CUSEVM features include:

- Industrial temperatures (-40°C to 85°C)
- Industrial temperature external magnetics
- Control and status:
  - Configurable 8 PHY Addresses – 01h (default) or any other address between 00h - 07h using jumpers as describes in [Table 1](#)
  - 8 LEDs – 2 power, 6 status LEDs (speed, link, and active data)
- Strap options:
  - MII/RMII jumper (MII disable)
  - Resistor strapping options:
    - Configurable PHY addresses 08h - 31h
    - CFG\_ANEG\_MODE
    - CFG\_ANAEG\_SPD\_0 ,1
    - CFG\_CROSSOVER
  - RESET \_N jumper
- Connections for the following interfaces:
  - MII connector
  - RJ-45 connector
- Single sided component placement
- On-board clock – crystal/oscillator dual footprint
- On-board power supplied by MII connector only, resistors to configure 5V or 3.3V operation

### 3.4 TLK110CUSEVM Block Diagram

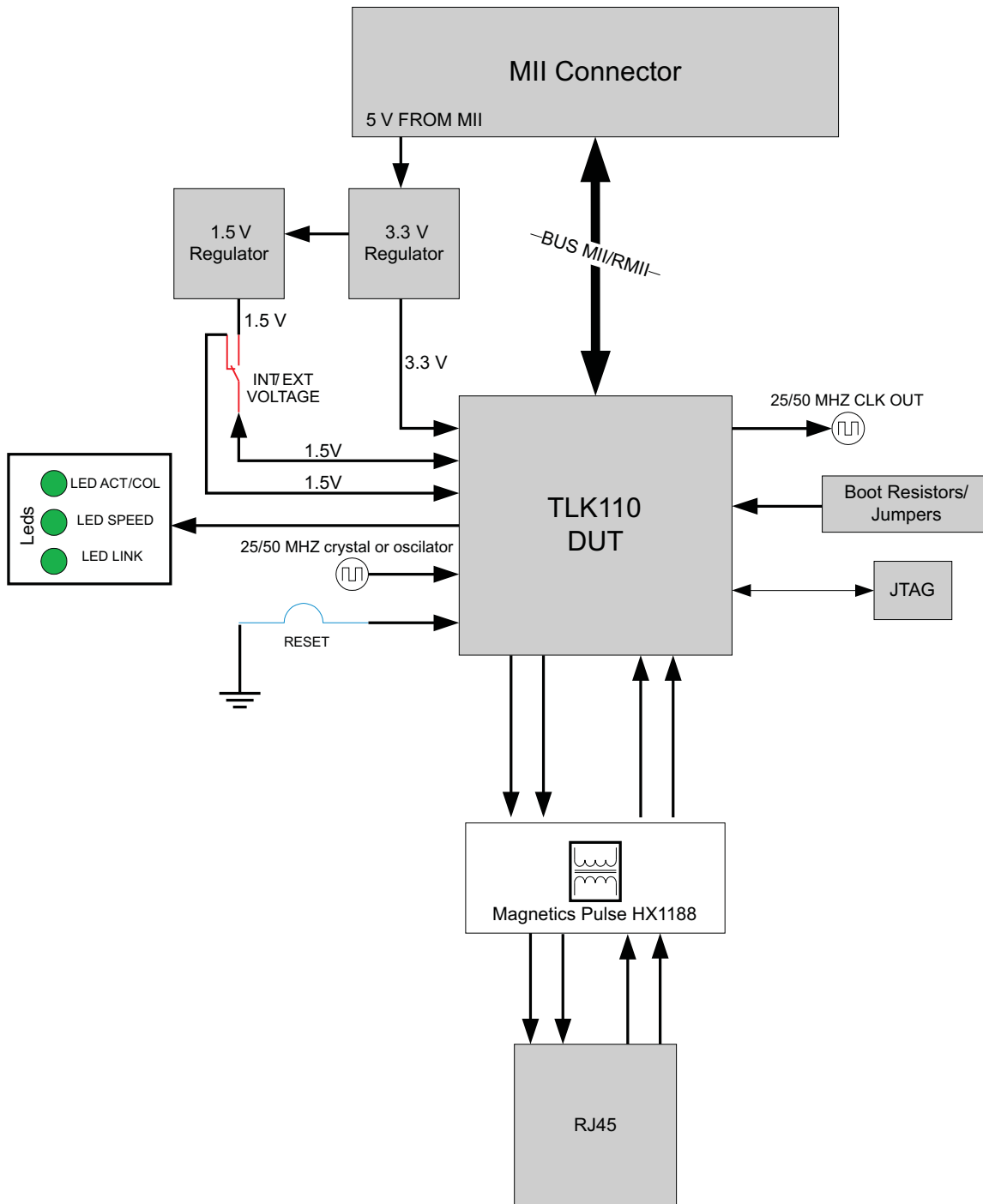

Figure 1. EVM Block Diagram

### 3.5 PCB Physical Layout

- FR4 material
- Trace impedance differential impedance 100 Ω, ±5%
- Uniform supply and ground planes
- 4 layers
- Combination of through-hole and surface mount technology

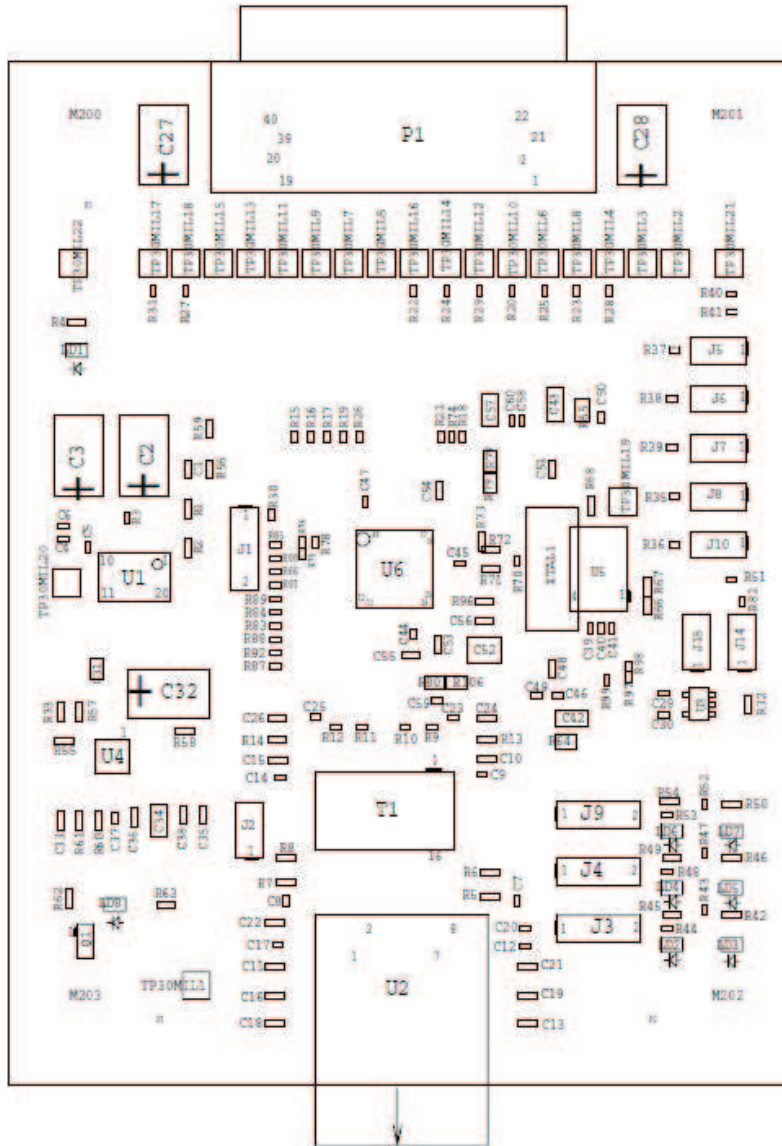
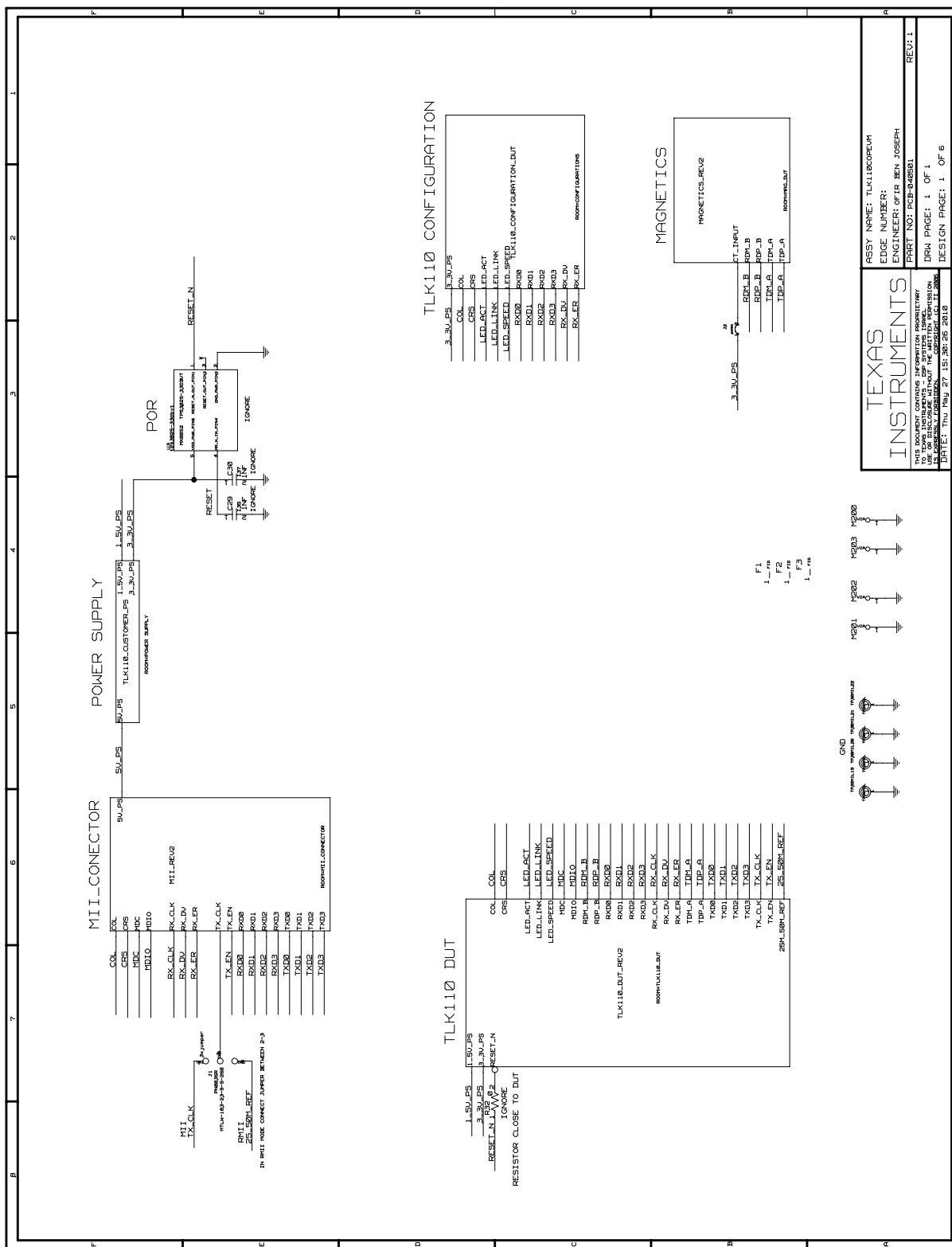

Figure 2. EVM Layout

**3.6 EVM Schematics**



**Figure 3. TLK110CUSEVM Top Level Schematics**



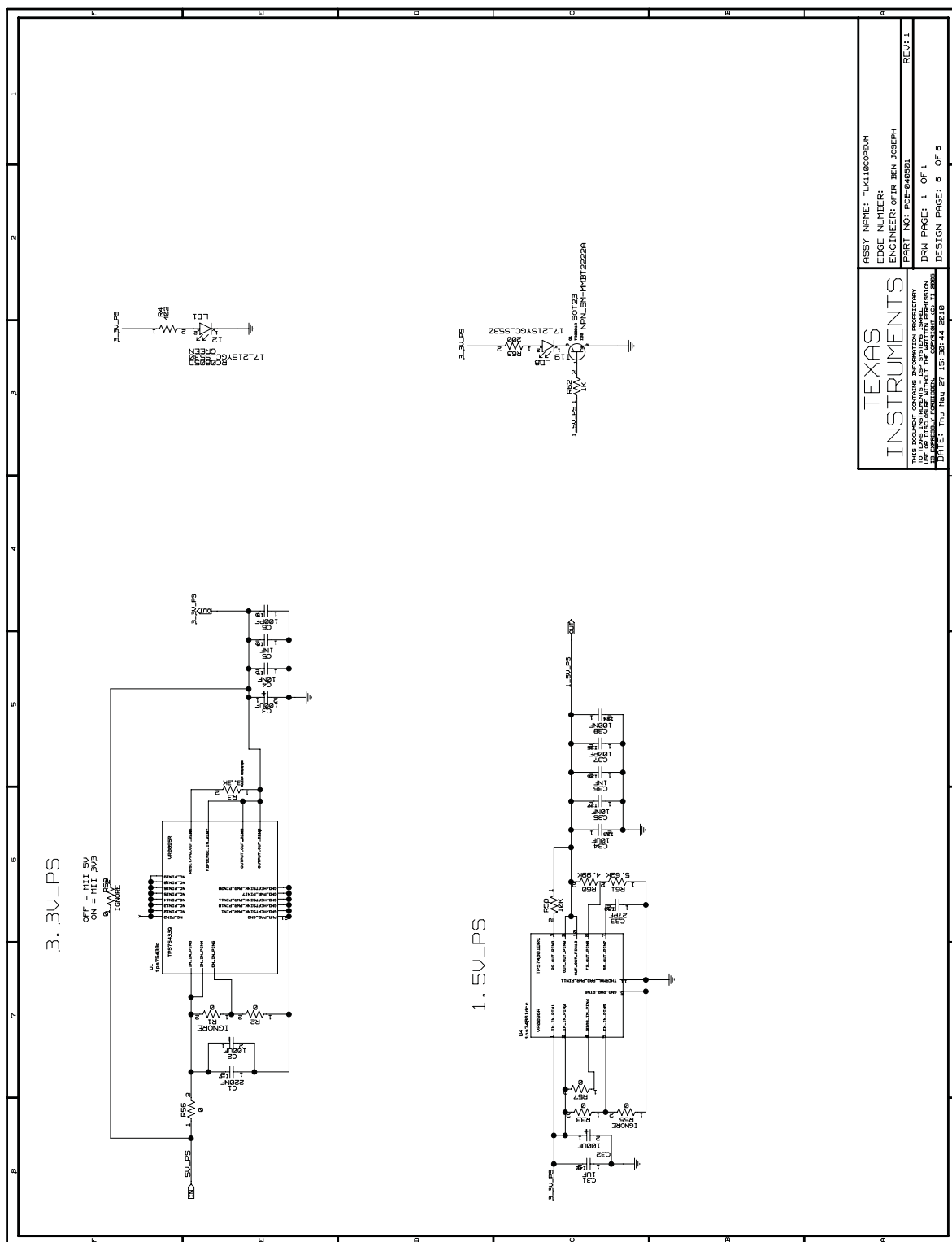

<b>TEXAS INSTRUMENTS</b>	ASSY NAME: TLK110COPDM
	EDGE NUMBER:
	ENGINEER: OFIR BEN JOSEPH
	PART NO: PCB-046501
<small>THIS DOCUMENT IS UNCLASSIFIED EXCEPT WHERE SHOWN OTHERWISE          TO EXCEED INFORMATION OF THE SYSTEM LEVEL.          UNCLASSIFIED//FORN DISSEM. CONTROLLED//NOFORN</small>	
DATE: Thu May 27 15:36:44 2010	
REV: 1	DRAW PAGE: 1 OF 1 DESIGN PAGE: 5 OF 5

Figure 5. TLK110CUSEVM 3.3V/1.5V LDO Schematics



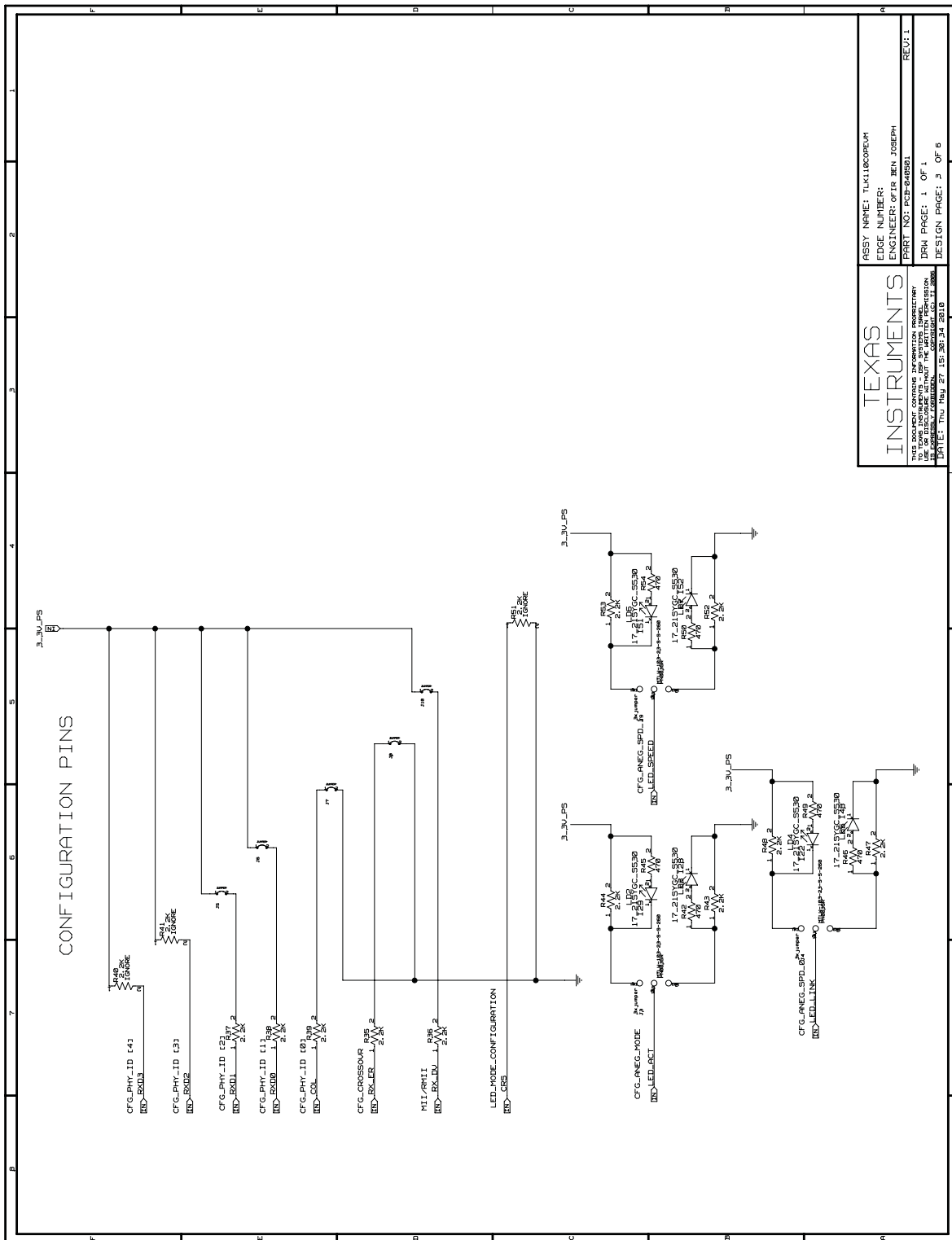

<b>TEXAS INSTRUMENTS</b>	ASSY NAME: TLK110CUSEVM
	EDGE NUMBER:
	ENGINEER: OFIR BEN JOSEPH
	PART NO: PCB-044501
DATE: Thu May 27 15:26:34 2011	
REV: 1	
DRAW PAGE: 1 OF 1	
DESIGN PAGE: 3 OF 5	

Figure 6. TLK110CUSEVM / SOR Schematics

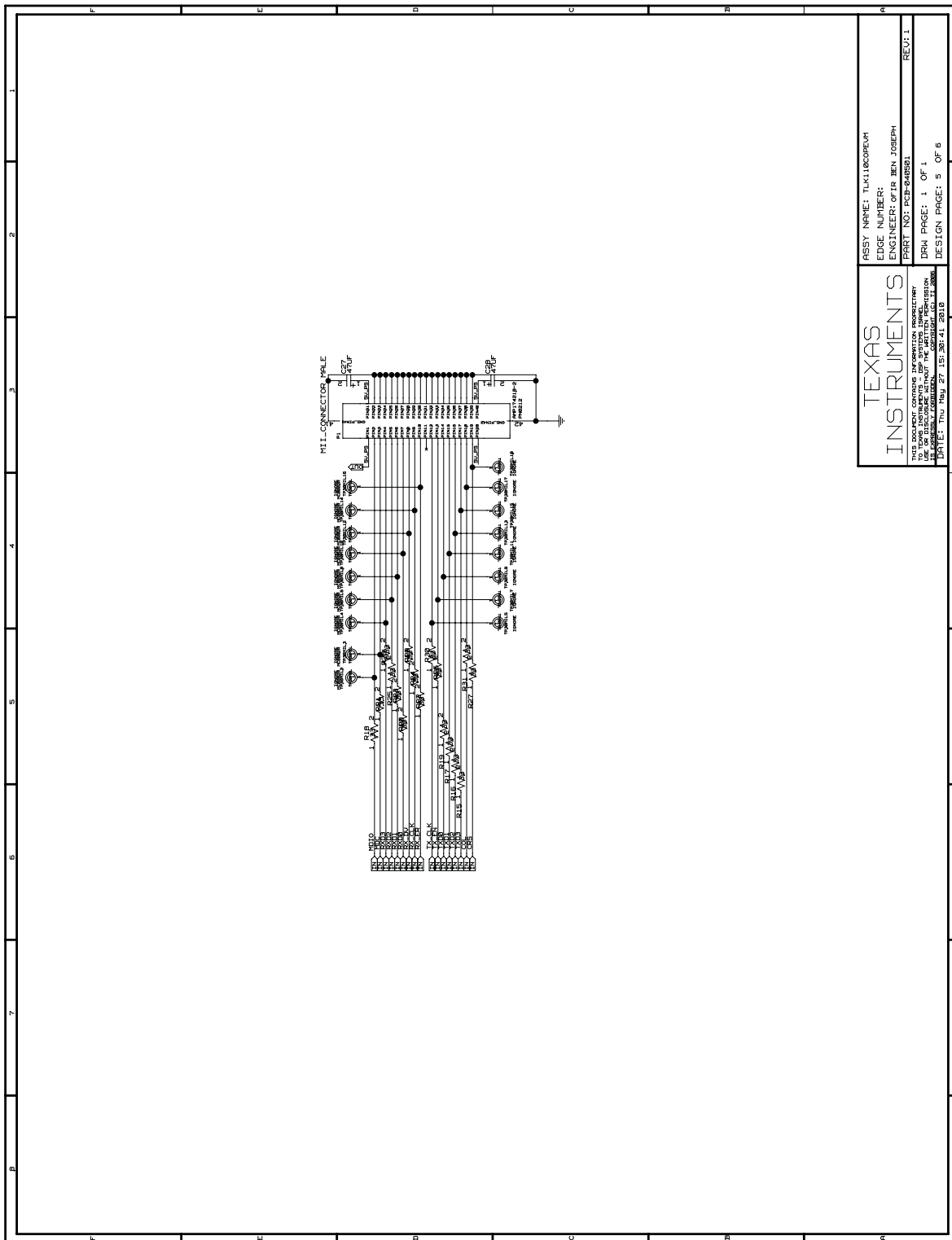

<b>TEXAS INSTRUMENTS</b>	ASSY NAME: TLK110CUSEVM EDGE NUMBER: ENGINEER: OFIR BEN JOSEPH
	PART NO: PCB-2445501 DRAW PAGE: 1 OF 1 DESIGN PAGE: 5 OF 5
THIS DOCUMENT IS UNCLASSIFIED. FOR INFORMATION ONLY. TO REPORT SUSPICIONS OF UNAUTHORIZED DISSEMINATION, CONTACT THE INFORMATION SECURITY CENTER AT (800) 752-8700. DATE: Thu May 27 15:38:41 2011	

Figure 7. TLK110CUSEVM / MII Connector Schematics

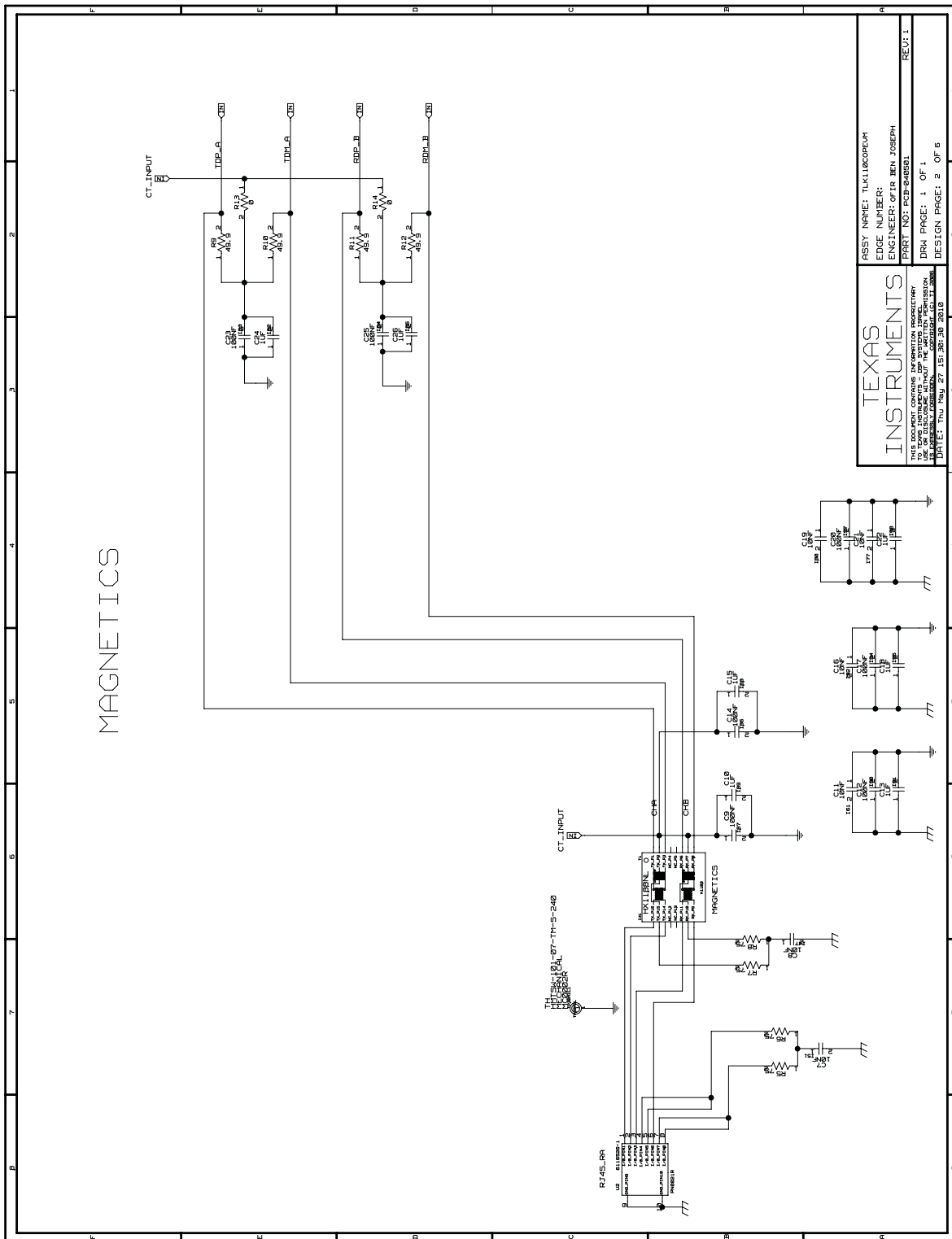

Figure 8. TLK110CUSEVM / Magnetics Schematics

### 3.7 Bill of Materials

**Table 3. Bill of Materials**

Part Name	Ref Des	Qty	JEDEC Type	Part No.	Vendor	Vendor Part No.	Value	BOM Ignore	Description	New Part No.
3XJUMPER_MECHANICAL	J1,J3,J4,J9	4	JUMPERX3	PN0035R	SAMTEC	MTLW-103-23-S-S-260	?	?	JUMPERX3 MALE	CON-103260R
8_POS_TH_MEC-PN0021R,8POS,6116526-1	U2	1	8POS	PN0021R	AMP-TYCO	6116526-1	?	?	RJ45 CAT5 8 POS RA Female	CON-111031R
CAPACITOR_SINGLE-CP0042,100NF,10V,10%,10%,RC0402,GMC04X7R104K10NT	C9,C12,C14,C17,C20,C23,C25	7	RC0402	CP0042	CALCHIP	GMC04X7R104K10NT	100NF	?	100NF_X7R_10V_10%_0402	CAT-400134R
CAPACITOR_SINGLE-CP0044,10NF,50V,10%,10%,RC0603,VJ0603Y103KXAT	C11, C16, C19, C21, C35	5	RC0603	CP0044	VITRAMON	VJ0603Y103KXAT	10NF	?	10NF_X7R_50V_10%_0603	CAP-601036R
CAPACITOR_SINGLE-CP0046,1NF,50V,5%,5%,RC0603,CL10B102JBNC	C36	1	RC0603	CP0046	SAMSUNG	CL10B102JBNC	1NF	?	1NF_X7R_50V_5%_0603	CAP-600106R
CAPACITOR_SINGLE-CP0067,10UF,35V,20%,20%,1206,CE_GMK325_F106ZHT	C34,C42,C43,C57	4	1206	CP0067	TAIYO_YUDEN	CE_GMK325_F106ZHT	10UF	?	10UF_Y5V_35V_20%_1206	CAP-401010R
CAPACITOR_SINGLE-CP0105,100NF,16V,10%,10%,0603,CL10B104KONC	C38,C53-C55	4	603	CP0105	SAMSUNG	CL10B104KONC	100NF	?	100NF_X7R_16V_10%_0603	CAP-400136R
CAPACITOR_SINGLE-CP0105,100NF,16V,10%,10%,0603,CL10B104KONC	C56	1	603	CP0105	SAMSUNG	CL10B104KONC	100NF	IGNORE	100NF_X7R_16V_10%_0603	CAP-400136R
CAPACITOR_SINGLE-CP0120,1UF,16V,80%,20%,0805,ECJ2VF1C105Z	C31	1	805	CP0120	PANASONIC	ECJ2VF1C105Z	1UF	?	1UF_Y5V_16V_+80%_-20%_0805	CAP-300108R
CAPACITOR_SINGLE-CP0135,1NF,25V,5%,5%,0402,VJ0402Y102JXXA	C29,C30	2	402	CP0135	VITRAMON	VJ0402Y102JXXA	1NF	IGNORE	1NF_X7R_25V_5%_0402	CAS-600104R
CAPACITOR_SINGLE-CP0135,1NF,25V,5%,5%,0402,VJ0402Y102JXXA	C5,C40,C46,C47,C59	5	402	CP0135	VITRAMON	VJ0402Y102JXXA	1NF	?	1NF_X7R_25V_5%_0402	CAS-600104R
CAPACITOR_SINGLE-CP0136,27PF,50V,1%,1%,0603,0603N270F500NT	C33	1	603	CP0136	HITANO	0603N270F500NT	27PF	?	27PF_NPO_50V_1%_0603	CAP-902716R
CAPACITOR_SINGLE-CP0146,10NF,50V,5%,5%,0402,CL05B103JBNC	C4,C7,C8,C39,C44,C45,C58	7	402	CP0146	SAMSUNG	CL05B103JBNC	10NF	?	10NF_X7R_50V_5%_0402	CAS-601034R
CAPACITOR_SINGLE-CP0147R,100PF,50V,5%,5%,RC0402,VJ0402A101JXAT	C6,C37,C41,C49,C50,C60	6	RC0402	CP0147R	VITRAMON	VJ0402A101JXAT	100PF	?	100PF_NPO_50V_5%_0402	CAP-910004R
CAPACITOR_SINGLE-CP0221,1UF,6.3V,15%,15%,0603,ECJ1VB0J105K	C10,C13,C15,C18,C22,C24,C26	7	603	CP0221	PANASONIC	ECJ1VB0J105K	1UF	?	1UF_X7R_6V3_15%_0603	CAS-300106R
CAPACITOR_SINGLE-CP0255,220NF,16V,5%,5%,0603,0603B224J160NT	C1	1	603	CP0255	HITANO	0603B224J160NT	220NF	?	220NF_16V_5%_0603	CAS-402236R
CAPACITOR_SINGLE-CP0259,33PF,50V,1%,1%,0603,CL10C330FB8NNNC	C48,C51	2	603	CP0259	SAMSUNG	CL10C330FB8NNNC	33PF	?	33PF_NPO_50V_1%_0603	CAP-903316R
CAPACITOR_SINGLE-XXXX,10UF,10V,10%,10%,1210,GRM32AR61C106KAB7L	C52	1	1210	XXXX	MURATA	GRM32AR61C106KAB7L	10UF	?	10UF_X5R_10V_10%_1210 LOW ESR	CAM-301005R
F4107R_SMT5X7-OS0040R,SMT5X7,VF3AH1-25MHZ	U5	1	SMT5X7	OS0040R	VALPEY_FISHER	VF3AH1-25MHZ	?	IGNORE	3.3V TIGHT STABILITY HCMOS SMD OSCILLATOR WITH STANDBY, 25MHz, 25ppm -40+85 (INDUSTRIAL)	OSC-507025R
FIDUSHEL	F1-F3	3	FIDUSHEL	?	?	?	?	?	?	?

**Table 3. Bill of Materials (continued)**

Part Name	Ref Des	Qty	JEDEC Type	Part No.	Vendor	Vendor Part No.	Value	BOM Ignore	Description	New Part No.
HC49SM_I-25M-INDUSTRIAL_OX0040R	XTAL1	1	HC49SM_I	OX0040R	HEC	HH2500-18-E-25PPM	?	?	XTAL HC49SM 25MHZ 100PPM 18PF INDUSTRIAL	CRS-250018R
HX1188NL_SM16-TF0116R,SM16,	T1	1	SM16	TF0122R	PULSE	HX1188NL	?	?	10/100 BASE-T MAGNETICS	CON-118800R
JUMPER_TH-PN0019,JMP02,90120-0762	J2,J5-J8,J10,J14	7	JMP02	PN0019	MOLEX	90120-0762	?	?	MOLEX JUMPER 0.1 INCH	CON-901202R
JUMPER_TH-PN0019,JMP02,90120-0762	J15	1	JMP02	PN0019	MOLEX	90120-0762	?	IGNORE	MOLEX JUMPER 0.1 INCH	CON-901202R
LED_SM-LD0021,50V,RC0805D,17_21SYGC_S530,GREEN	LD1-LD8	8	RC0805D	LD0021	EVERLIGHT	17_21SYGC_S530	?	?	GREEN_LED_SMD_0805	LED-215301R
MII-PN0212,_AMP174218-2	P1	1	MII-MALE	PN0212	AMP	AMP174218-2	?	?	MII_40PIN_SHILDED_THRA_MALE	CON-174218R
NPN_IC-MMBT222AA-TR0001R	Q1	1	SOT23	TR0001R	XXXX	NPN-SM-MMBT222A	?	?	NPN SOT23 TRANSISTOR	TRS-104023R
PCAP_SINGLE-CT0024,100UF,10V,20%,20%,7343,EEJL1AD107R	C2,C3,C32	3	7343	CT0024	PANASONIC	EEJL1AD107R	100UF	?	100UF_10V_20%_Tantalum_Low_ES R_D_Size	CAP-100343R
PCAP_SINGLE-CT0026R,47UF,20V,10%,10%,7343,TCSVS1D476KDAR	C27,C28	2	7343	CT0026R	SAMSUNG	TCSVS1D476KDAR	47UF	?	47UF_TANT_20V_10%_7343	CAP-047343R
RESISTOR_2PIN-RE0004,0,0.06W,5%,RC0603JW_000E	R1,R32,R55,R59,R67,R73	6	603	RE0004	BOURNS	RC0603JW_000E	0	IGNORE	0_0W06_5%_0603	RES-100006R
RESISTOR_2PIN-RE0004,0,0.06W,5%,RC0603JW_000E	R2,R13,R14,R33,R56,R57,R66,R71,R72	9	603	RE0004	BOURNS	RC0603JW_000E	0	?	0_0W06_5%_0603	RES-100006R
RESISTOR_2PIN-RE0005,0,0.1W,5%,RC0805JW_000E	R64,R65,R79,R106	4	805	RE0005	BOURNS	RC0805JW_000E	0	?	0R_0W1_5%_0805	RES-100008R
RESISTOR_2PIN-RE0005,0,0.1W,5%,RC0805JW_000E	R77,R80	2	805	RE0005	BOURNS	RC0805JW_000E	0	IGNORE	0R_0W1_5%_0805	RES-100008R
RESISTOR_2PIN-RE0044,4.7K,0.06W,5%,CR0603JW-472E	R68	1	603	RE0044	BOURNS	CR0603JW-472E	4.7K	?	4K7_0W06_5%_0603	RES-404706R
RESISTOR_2PIN-RE0085,49.9,0.06W,1%,RC0402FR-0749R9	R9-R12	4	402	RE0085	YAGEO	RC0402FR-0749R9	49.9	?	49R9_0W06_1%_0402	RES-249914R
RESISTOR_2PIN-RE0114R,4.99K,0.06W,1%,CR0603-FX-4991ELF	R60	1	RC0603	RE0114R	BOURNS	CR0603-FX-4991ELF	4.99K	?	RESISTOR_4.99K_1%_0603	RES-349906R
RESISTOR_2PIN-RE0125,1K,0.06W,1%,CR0603FX_1001E	R62	1	603	RE0125	YAGEO	CR0603FX_1001E	1K	?	1K_0W06_1%_0603	RES-300106R
RESISTOR_2PIN-RE0152,470,0.1W,1%,CR0603FX-470R	R42,R45,R46,R49,R50,R54	6	603	RE0152	YAGEO	CR0603FX-470R	470	?	470_0W1_1%_0603	RES-147006R
RESISTOR_2PIN-RE0182,10K,0.06W,1%,RC0603FR_0710K	R58	1	603	RE0182	YAGEO	RC0603FR_0710K	10K	?	10K_0W06_1%_0603	RES-301006R
RESISTOR_2PIN-RE0218,200,0.06W,1%,RC0603FR-07200R	R63	1	603	RE0218	AVX	RC0603FR-07200R	200	?	200R_0W06_1%_0603	RES-320006R
RESISTOR_2PIN-RE0294,75,0.06W,1%,CR0603FX_75R	R5-R8	4	603	RE0294	YAGEO	CR0605FX_75R	75	?	75R_0W06_1%_0603	RES-107506R
RESISTOR_2PIN-RE0343,3.3K,0.06W,1%,CR0402FX-3301G	R3	1	402	RE0343	YAGEO	CR0402FX-3301G	3.3K	?	3K3_0W06_1%_0402	RES-403304R
RESISTOR_2PIN-RE0475,5.62K,0.06W,1%,RC0603FR-075K62	R61	1	603	RE0475	YAGEO	RC0603FR-075K62	5.62K	?	5K62_0W06_1%_0603	RES-856216R
RESISTOR_2PIN-RE0518R,402,0.06W,1%,CR0603-FX-402RELF	R4	1	603	RE0518R	BOURNS	CR0603-FX-402RELF	402	?	RESISTOR_402OHM_1%_0603	RES-140206R
RESISTOR_2PIN-RE0536R,1M,0.06W,1%,RC0402FR-071M	R70	1	RC0402	RE0536R	YAGEO	RC0402FR-071M	1M	?	RESISTOR_1M_1%_0402	RES-600104R

**Table 3. Bill of Materials (continued)**

Part Name	Ref Des	Qty	JEDEC Type	Part No.	Vendor	Vendor Part No.	Value	BOM Ignore	Description	New Part No.
RESISTOR_2PIN-RE0661R,2.2K,0.06W,1%,CR0402FR-072K2L	R35-R39, R43,R44, R47, R48, R52, R53, R74, R75, R82, R97, R99	16	402	RE0661R	YAGEO	CR0402FR-072K2L	2.2K	?	2.2K_0W06_1%_0402	RES-402204R
RESISTOR_2PIN-RE0661R,2.2K,0.06W,1%,CR0402FR-072K2L	R40, R41, R51, R76, R78, R83-R92, R98	16	402	RE0661R	YAGEO	CR0402FR-072K2L	2.2K	IGNORE	2.2K_0W06_1%_0402	RES-402204R
RESISTOR_2PIN-RE0662R,33,0.06W,1%,CR0402FR-0733R	R15-R31	17	402	RE0662R	YAGEO	CR0402FR-0733R	33	?	33_0W06_1%_0402	RES-103304R
RESISTOR_2PIN-XXXX,4.87K,0.06W,1%,CR0603-FX-4871ELF	R96	1	RC0603	XXXX	BOURNS	CR0603-FX-4871ELF	4.87K	?	RESISTOR_4.87K_1%_0603	RES-404876R
TLK110_REV4_IC-XXXX.	U6	1	QFP50P900X900 X120-49	XXXX	TI	TLK110	?	?	INDUSTRIAL ETHERNET 10/100BT	CON-110000R
TP30MIL_MECHANICAL-MC0002R	TP30MIL1, TP30MIL19-TP30MIL22	5	TH	MC0002R	SAMTEC	HMTSW-101-07-TM-S-240	?	?	TESTPOINT_TH_0.9mm_pad_1.7MM	CON-101240R
TP30MIL_MECHANICAL-MC0002R	TP30MIL2-TP30MIL18	17	TH	MC0002R	SAMTEC	HMTSW-101-07-TM-S-240	?	IGNORE	TESTPOINT_TH_0.9mm_pad_1.7MM	CON-101240R
TPM_MECH_VIA	M200-M203	4	TPM_MECH_VIA	?	?	?	?	?	?	?
TPS3825-33DBVT_IC-MX0052,DBV,TPS3825-33DBVT	U3	1	DBV	MX0052	TI	TPS3825-33DBVT	?	IGNORE	PROCESSOR SUPERVISORY CIRCUITS WITH MR_N INPUT	REG-382533R
TPS74801DRC_IC-VR0096R,SON10,TPS74801DRC	U4	1	SON10	VR0096R	TI	TPS74801DRC	?	?	LDO 1.5A ADJ	REG-748010R
TPS75433Q_IC-VR0095R,TSSOP-20,TPS75433Q	U1	1	TSSOP-20	VR0095R	TI	TPS75433Q	?	?	LDO 3.3V 2A	REG-754330R

## 4 Software

The EVM does not require any specific software and can be controlled with networking equipment that support a MII interface. However for SmartBits users, TI can provide a proprietary GUI that simplifies the controllability of the TLK110CUSEVM through SmartBits and allows advanced features such as a cable diagnostic tool.

## Evaluation Board/Kit Important Notice

Texas Instruments (TI) provides the enclosed product(s) under the following conditions:

This evaluation board/kit is intended for use for **ENGINEERING DEVELOPMENT, DEMONSTRATION, OR EVALUATION PURPOSES ONLY** and is not considered by TI to be a finished end-product fit for general consumer use. Persons handling the product(s) must have electronics training and observe good engineering practice standards. As such, the goods being provided are not intended to be complete in terms of required design-, marketing-, and/or manufacturing-related protective considerations, including product safety and environmental measures typically found in end products that incorporate such semiconductor components or circuit boards. This evaluation board/kit does not fall within the scope of the European Union directives regarding electromagnetic compatibility, restricted substances (RoHS), recycling (WEEE), FCC, CE or UL, and therefore may not meet the technical requirements of these directives or other related directives.

Should this evaluation board/kit not meet the specifications indicated in the User's Guide, the board/kit may be returned within 30 days from the date of delivery for a full refund. **THE FOREGOING WARRANTY IS THE EXCLUSIVE WARRANTY MADE BY SELLER TO BUYER AND IS IN LIEU OF ALL OTHER WARRANTIES, EXPRESSED, IMPLIED, OR STATUTORY, INCLUDING ANY WARRANTY OF MERCHANTABILITY OR FITNESS FOR ANY PARTICULAR PURPOSE.**

The user assumes all responsibility and liability for proper and safe handling of the goods. Further, the user indemnifies TI from all claims arising from the handling or use of the goods. Due to the open construction of the product, it is the user's responsibility to take any and all appropriate precautions with regard to electrostatic discharge.

**EXCEPT TO THE EXTENT OF THE INDEMNITY SET FORTH ABOVE, NEITHER PARTY SHALL BE LIABLE TO THE OTHER FOR ANY INDIRECT, SPECIAL, INCIDENTAL, OR CONSEQUENTIAL DAMAGES.**

TI currently deals with a variety of customers for products, and therefore our arrangement with the user **is not exclusive.**

TI assumes **no liability for applications assistance, customer product design, software performance, or infringement of patents or services described herein.**

Please read the User's Guide and, specifically, the Warnings and Restrictions notice in the User's Guide prior to handling the product. This notice contains important safety information about temperatures and voltages. For additional information on TI's environmental and/or safety programs, please contact the TI application engineer or visit [www.ti.com/esh](http://www.ti.com/esh).

No license is granted under any patent right or other intellectual property right of TI covering or relating to any machine, process, or combination in which such TI products or services might be or are used.

## FCC Warning

This evaluation board/kit is intended for use for **ENGINEERING DEVELOPMENT, DEMONSTRATION, OR EVALUATION PURPOSES ONLY** and is not considered by TI to be a finished end-product fit for general consumer use. It generates, uses, and can radiate radio frequency energy and has not been tested for compliance with the limits of computing devices pursuant to part 15 of FCC rules, which are designed to provide reasonable protection against radio frequency interference. Operation of this equipment in other environments may cause interference with radio communications, in which case the user at his own expense will be required to take whatever measures may be required to correct this interference.

## EVM Warnings and Restrictions

It is important to operate this EVM within the input voltage range of 5 V or 3.3 V and the output voltage range of N/A V to N/A V .

Exceeding the specified input range may cause unexpected operation and/or irreversible damage to the EVM. If there are questions concerning the input range, please contact a TI field representative prior to connecting the input power.

Applying loads outside of the specified output range may result in unintended operation and/or possible permanent damage to the EVM. Please consult the EVM User's Guide prior to connecting any load to the EVM output. If there is uncertainty as to the load specification, please contact a TI field representative.

During normal operation, some circuit components may have case temperatures greater than 60° C. The EVM is designed to operate properly with certain components above 60° C as long as the input and output ranges are maintained. These components include but are not limited to linear regulators, switching transistors, pass transistors, and current sense resistors. These types of devices can be identified using the EVM schematic located in the EVM User's Guide. When placing measurement probes near these devices during operation, please be aware that these devices may be very warm to the touch.

Mailing Address: Texas Instruments, Post Office Box 655303, Dallas, Texas 75265  
Copyright © 2011, Texas Instruments Incorporated



## IMPORTANT NOTICE

Texas Instruments Incorporated and its subsidiaries (TI) reserve the right to make corrections, modifications, enhancements, improvements, and other changes to its products and services at any time and to discontinue any product or service without notice. Customers should obtain the latest relevant information before placing orders and should verify that such information is current and complete. All products are sold subject to TI's terms and conditions of sale supplied at the time of order acknowledgment.

TI warrants performance of its hardware products to the specifications applicable at the time of sale in accordance with TI's standard warranty. Testing and other quality control techniques are used to the extent TI deems necessary to support this warranty. Except where mandated by government requirements, testing of all parameters of each product is not necessarily performed.

TI assumes no liability for applications assistance or customer product design. Customers are responsible for their products and applications using TI components. To minimize the risks associated with customer products and applications, customers should provide adequate design and operating safeguards.

TI does not warrant or represent that any license, either express or implied, is granted under any TI patent right, copyright, mask work right, or other TI intellectual property right relating to any combination, machine, or process in which TI products or services are used. Information published by TI regarding third-party products or services does not constitute a license from TI to use such products or services or a warranty or endorsement thereof. Use of such information may require a license from a third party under the patents or other intellectual property of the third party, or a license from TI under the patents or other intellectual property of TI.

Reproduction of TI information in TI data books or data sheets is permissible only if reproduction is without alteration and is accompanied by all associated warranties, conditions, limitations, and notices. Reproduction of this information with alteration is an unfair and deceptive business practice. TI is not responsible or liable for such altered documentation. Information of third parties may be subject to additional restrictions.

Resale of TI products or services with statements different from or beyond the parameters stated by TI for that product or service voids all express and any implied warranties for the associated TI product or service and is an unfair and deceptive business practice. TI is not responsible or liable for any such statements.

TI products are not authorized for use in safety-critical applications (such as life support) where a failure of the TI product would reasonably be expected to cause severe personal injury or death, unless officers of the parties have executed an agreement specifically governing such use. Buyers represent that they have all necessary expertise in the safety and regulatory ramifications of their applications, and acknowledge and agree that they are solely responsible for all legal, regulatory and safety-related requirements concerning their products and any use of TI products in such safety-critical applications, notwithstanding any applications-related information or support that may be provided by TI. Further, Buyers must fully indemnify TI and its representatives against any damages arising out of the use of TI products in such safety-critical applications.

TI products are neither designed nor intended for use in military/aerospace applications or environments unless the TI products are specifically designated by TI as military-grade or "enhanced plastic." Only products designated by TI as military-grade meet military specifications. Buyers acknowledge and agree that any such use of TI products which TI has not designated as military-grade is solely at the Buyer's risk, and that they are solely responsible for compliance with all legal and regulatory requirements in connection with such use.

TI products are neither designed nor intended for use in automotive applications or environments unless the specific TI products are designated by TI as compliant with ISO/TS 16949 requirements. Buyers acknowledge and agree that, if they use any non-designated products in automotive applications, TI will not be responsible for any failure to meet such requirements.

Following are URLs where you can obtain information on other Texas Instruments products and application solutions:

### Products

Audio	<a href="http://www.ti.com/audio">www.ti.com/audio</a>
Amplifiers	<a href="http://amplifier.ti.com">amplifier.ti.com</a>
Data Converters	<a href="http://dataconverter.ti.com">dataconverter.ti.com</a>
DLP® Products	<a href="http://www.dlp.com">www.dlp.com</a>
DSP	<a href="http://dsp.ti.com">dsp.ti.com</a>
Clocks and Timers	<a href="http://www.ti.com/clocks">www.ti.com/clocks</a>
Interface	<a href="http://interface.ti.com">interface.ti.com</a>
Logic	<a href="http://logic.ti.com">logic.ti.com</a>
Power Mgmt	<a href="http://power.ti.com">power.ti.com</a>
Microcontrollers	<a href="http://microcontroller.ti.com">microcontroller.ti.com</a>
RFID	<a href="http://www.ti-rfid.com">www.ti-rfid.com</a>
OMAP Mobile Processors	<a href="http://www.ti.com/omap">www.ti.com/omap</a>
Wireless Connectivity	<a href="http://www.ti.com/wirelessconnectivity">www.ti.com/wirelessconnectivity</a>

### Applications

Communications and Telecom	<a href="http://www.ti.com/communications">www.ti.com/communications</a>
Computers and Peripherals	<a href="http://www.ti.com/computers">www.ti.com/computers</a>
Consumer Electronics	<a href="http://www.ti.com/consumer-apps">www.ti.com/consumer-apps</a>
Energy and Lighting	<a href="http://www.ti.com/energy">www.ti.com/energy</a>
Industrial	<a href="http://www.ti.com/industrial">www.ti.com/industrial</a>
Medical	<a href="http://www.ti.com/medical">www.ti.com/medical</a>
Security	<a href="http://www.ti.com/security">www.ti.com/security</a>
Space, Avionics and Defense	<a href="http://www.ti.com/space-avionics-defense">www.ti.com/space-avionics-defense</a>
Transportation and Automotive	<a href="http://www.ti.com/automotive">www.ti.com/automotive</a>
Video and Imaging	<a href="http://www.ti.com/video">www.ti.com/video</a>

TI E2E Community Home Page

[e2e.ti.com](http://e2e.ti.com)

Mailing Address: Texas Instruments, Post Office Box 655303, Dallas, Texas 75265  
Copyright © 2011, Texas Instruments Incorporated