

## EQW010-040 Series (Eighth-Brick) DC-DC Converter Power Modules

**36–75Vdc Input; 1.0 to 12.0Vdc Output; 10 to 40A Output Current**



**RoHS Compliant**

### Applications

- Distributed power architectures
- Wireless networks
- Access and optical network Equipment
- Enterprise Networks
- Latest generation IC's (DSP, FPGA, ASIC) and Microprocessor powered applications

### Options

- Negative Remote On/Off logic
- Over current/Over temperature/Over voltage protections (Auto-restart)
- Heat plate versions (-C, -H)
- Surface Mount version (-S)

### Description

The EQW010/040 series DC-DC converters are designed to provide up to 40A output current in an industry standard eighth brick package. These DC-DC converters operate over an input voltage range of 36 to 75 Vdc and provide a single, precisely-regulated output. The output is isolated from the input, allowing versatile polarity configurations and grounding connections. Built in filtering for both the input and output minimizes the need for external filtering.

### Features

- Compliant to RoHS EU Directive 2002/95/EC
- Compatible in a Pb-free or SnPb reflow environment
- High efficiency – 92% at 3.3V full load
- Industry standard, DOSA compliant, Eighth brick footprint  
57.9mm x 22.9mm x 8.5mm  
(2.28in x 0.9in x 0.335in)
- Wide Input voltage range: 36-75 Vdc
- Tightly regulated output
- Constant switching frequency
- Positive Remote On/Off logic
- Input under/over voltage protection
- Output overcurrent/voltage protection
- Over-temperature protection
- Remote sense
- No minimum load required
- No reverse current during output shutdown
- Output Voltage adjust: 80% to 110% of  $V_{o,nom}$
- Operating temperature range (-40°C to 85°C)
- *UL*\* 60950-1 Recognized, *CSA*<sup>†</sup> C22.2 No. 60950-1-03 Certified, and *VDE*<sup>‡</sup> 0805:2001-12 (EN60950-1) Licensed
- CE mark meets 73/23/EEC and 96/68/EEC directives<sup>§</sup>
- Meets the voltage and current requirements for ETSI 300-132-2 and complies with and licensed for Basic insulation rating per EN60950-1
- *ISO*<sup>\*\*</sup> 9001 and *ISO* 14001 certified manufacturing facilities

\* *UL* is a registered trademark of Underwriters Laboratories, Inc.

<sup>†</sup> *CSA* is a registered trademark of Canadian Standards Association.

<sup>‡</sup> *VDE* is a trademark of Verband Deutscher Elektrotechniker e.V.

<sup>§</sup> This product is intended for integration into end-user equipment

<sup>\*\*</sup> *ISO* is a registered trademark of the International Organization of Standards

## Absolute Maximum Ratings

Stresses in excess of the absolute maximum ratings can cause permanent damage to the device. These are absolute stress ratings only, functional operation of the device is not implied at these or any other conditions in excess of those given in the operations sections of the data sheet. Exposure to absolute maximum ratings for extended periods can adversely affect the device reliability.

Parameter	Device	Symbol	Min	Max	Unit
Input Voltage					
Continuous	All	$V_{IN}$	-0.3	80	$V_{dc}$
Transient (100 ms)	All	$V_{IN,trans}$	-0.3	100	$V_{dc}$
Operating Ambient Temperature (see Thermal Considerations section)	All	$T_A$	-40	85	$^{\circ}C$
Storage Temperature	All	$T_{stg}$	-55	125	$^{\circ}C$
I/O Isolation voltage (100% factory Hi-Pot tested)	All	—	—	1500	$V_{dc}$

## Electrical Specifications

Unless otherwise indicated, specifications apply over all operating input voltage, resistive load, and temperature conditions.

Parameter	Device	Symbol	Min	Typ	Max	Unit
Operating Input Voltage	All	$V_{IN}$	36	48	75	$V_{dc}$
Maximum Input Current ( $V_{IN} = V_{IN,min}$ to $V_{IN,max}$ , $I_O = I_{O,max}$ )	All, except B B	$I_{IN,max}$ $I_{IN,max}$		3.2 3.4	3.5 3.7	$A_{dc}$ $A_{dc}$
Input No Load Current ( $V_{IN} = V_{IN,nom}$ , $I_O = 0$ , module enabled)	All	$I_{IN,No\ load}$			75	mA
Input Stand-by Current ( $V_{IN} = V_{IN,nom}$ , module disabled)	All	$I_{IN,stand-by}$			22	mA
Inrush Transient	All	$I^2t$			0.5	$A^2s$
Input Reflected Ripple Current, peak-to-peak (5Hz to 20MHz, 1 $\mu$ H source impedance; $V_{IN,min}$ to $V_{IN,max}$ , $I_O = I_{O,max}$ ; See Test configuration section)	All				20	$mA_{p-p}$
Input Ripple Rejection (120Hz)	All			50		dB

### CAUTION: This power module is not internally fused. An input line fuse must always be used.

This power module can be used in a wide variety of applications, ranging from simple standalone operation to an integrated part of sophisticated power architectures. To preserve maximum flexibility, internal fusing is not included, however, to achieve maximum safety and system protection, always use an input line fuse. The safety agencies require a time-delay fuse with a maximum rating of 8 A (see Safety Considerations section). Based on the information provided in this data sheet on inrush energy and maximum dc input current, the same type of fuse with a lower rating can be used. Refer to the fuse manufacturer's data sheet for further information.

## Electrical Specifications (continued)

Parameter	Device	Symbol	Min	Typ	Max	Unit
Nominal Output Voltage Set-point $V_{IN}=V_{IN, min}, I_O=I_{O, max}, T_A=25^{\circ}C$	B	$V_{O, set}$	11.76	12.0	12.24	$V_{dc}$
	A	$V_{O, set}$	4.90	5.0	5.10	$V_{dc}$
	F	$V_{O, set}$	3.23	3.3	3.37	$V_{dc}$
	G	$V_{O, set}$	2.45	2.5	2.55	$V_{dc}$
	Y	$V_{O, set}$	1.76	1.8	1.84	$V_{dc}$
	M	$V_{O, set}$	1.47	1.5	1.53	$V_{dc}$
	P	$V_{O, set}$	1.18	1.2	1.22	$V_{dc}$
	S1R0	$V_{O, set}$	0.98	1.0	1.02	$V_{dc}$
Output Voltage (Over all operating input voltage, resistive load, and temperature conditions until end of life)	All	$V_O$	-3.0	—	+3.0	% $V_{O, set}$
Output Regulation Line ( $V_{IN}=V_{IN, min}$ to $V_{IN, max}$ )	B, A, F, G Y, M, P, S1R0		—	—	0.2	% $V_{O, set}$
Load ( $I_O=I_{O, min}$ to $I_{O, max}$ )	B, A, F, G Y, M, P, S1R0		—	—	5	mV
Temperature ( $T_{ref}=T_{A, min}$ to $T_{A, max}$ )	All		—	—	0.2	% $V_{O, set}$
			—	—	5	mV
			—	—	1.0	% $V_{O, set}$
Output Ripple and Noise on nominal output ( $V_{IN}=V_{IN, nom}, I_O=I_{O, max}, T_A=T_{A, min}$ to $T_{A, max}$ )						
RMS (5Hz to 20MHz bandwidth)	B		—	—	30	$mV_{rms}$
Peak-to-Peak (5Hz to 20MHz bandwidth)	B		—	—	100	$mV_{pk-pk}$
RMS (5Hz to 20MHz bandwidth)	All, except B		—	—	25	$mV_{rms}$
Peak-to-Peak (5Hz to 20MHz bandwidth)	All, except B		—	—	75	$mV_{pk-pk}$
External Capacitance	B	$C_{O, max}$	0	—	1,500	$\mu F$
	A	$C_{O, max}$	0	—	10,000	$\mu F$
	F, G, Y, M, P, S1R0	$C_{O, max}$	0*	—	20,000	$\mu F$
Output Current	B	$I_O$	0	—	10	$A_{dc}$
	A	$I_O$	0	—	20	$A_{dc}$
	F	$I_O$	0	—	30	$A_{dc}$
	G	$I_O$	0	—	35	$A_{dc}$
	Y, M, P, S1R0	$I_O$	0	—	40	$A_{dc}$
Output Current Limit Inception (Hiccup Mode ) ( $V_O=90\%$ of $V_{O, set}$ )	All, except G	$I_{O, lim}$	105	115	130	% $I_O$
	G	$I_{O, lim}$	103	115	130	% $I_O$
Output Short-Circuit Current ( $V_O \leq 250mV$ ) ( Hiccup Mode )	All	$I_{O, s/c}$	—	130	150	$A_{rms}$
Efficiency $V_{IN}=V_{IN, nom}, T_A=25^{\circ}C$ $I_O=I_{O, max}, V_O=V_{O, set}$	B	$\eta$		93.0		%
	A	$\eta$		91.7		%
	F	$\eta$		92.0		%
	G	$\eta$		89.8		%
	Y	$\eta$		88.3		%
	M	$\eta$		87.1		%
	P	$\eta$		85.0		%
	S1R0	$\eta$		83.2		%
Switching Frequency	All	$f_{sw}$		420		kHz

\* Note: For 1.0V<sub>O</sub> (S1R0) and 1.2 V<sub>O</sub> (P) device codes, external capacitance, C<sub>O</sub>, should be 1000uF minimum to achieve monotonic start-up with very light load ( $\leq 2A$ mp).

## Electrical Specifications (continued)

Parameter	Device	Symbol	Min	Typ	Max	Unit
Dynamic Load Response ( $dI_o/dt=0.1A/\mu s$ ; $V_{IN} = V_{IN, nom}$ ; $T_A=25^\circ C$ ) Load Change from $I_o= 50\%$ to $75\%$ or $25\%$ to $50\%$ of $I_{o, max}$ ; Peak Deviation Settling Time ( $V_o<10\%$ peak deviation)	All	$V_{pk}$	—	3	—	% $V_{O, set}$
	All	$t_s$	—	200	—	$\mu s$
( $dI_o/dt=1A/\mu s$ ; $V_{IN} = V_{IN, nom}$ ; $T_A=25^\circ C$ ) Load Change from $I_o= 50\%$ to $75\%$ or $25\%$ to $50\%$ of $I_{o, max}$ ; Peak Deviation Settling Time ( $V_o<10\%$ peak deviation)	All	$V_{pk}$	—	5	—	% $V_{O, set}$
	All	$t_s$	—	200	—	$\mu s$

## Isolation Specifications

Parameter	Device	Symbol	Min	Typ	Max	Unit
Isolation Capacitance	All	$C_{iso}$	—	1000	—	pF
Isolation Resistance	All	$R_{iso}$	10	—	—	M $\Omega$
I/O Isolation Voltage (100% factory Hi-pot tested)	All	All	—	—	1500	V <sub>dc</sub>

## General Specifications

Parameter	Device	Symbol	Min	Typ	Max	Unit
Calculated Reliability based upon Telcordia SR-332 Issue 2: Method I Case 3 ( $I_o=80\%I_{O, max}$ , $T_A=40^\circ C$ , airflow = 200 lfm, 90% confidence)	B	FIT		334		$10^9$ /Hours
	A-S	FIT		290		$10^9$ /Hours
	F	FIT		328		$10^9$ /Hours
	Y	FIT		302		$10^9$ /Hours
	B	MTBF		2,997,896		Hours
	A-S	MTBF		3,451,558		Hours
	F	MTBF		3,051,626		Hours
	Y	MTBF		3,312,888		Hours
Weight	All		—	20.5 (0.72)	—	g (oz.)

## Feature Specifications

Unless otherwise indicated, specifications apply over all operating input voltage, resistive load, and temperature conditions. See Feature Descriptions for additional information.

Parameter	Device	Symbol	Min	Typ	Max	Unit
Remote On/Off Signal Interface ( $V_{IN}=V_{IN, min}$ to $V_{IN, max}$ ; open collector or equivalent, Signal referenced to $V_{IN}$ terminal) Negative Logic: device code suffix "1" Logic Low = module On, Logic High = module Off Positive Logic: No device code suffix required Logic Low = module Off, Logic High = module On Logic Low - Remote On/Off Current Logic Low - On/Off Voltage Logic High Voltage – (Typ = Open Collector) Logic High maximum allowable leakage current	All	$I_{on/off}$	—	—	1.0	mA
	All	$V_{on/off}$	-0.7	—	1.2	$V_{dc}$
	All	$V_{on/off}$	—	—	5	$V_{dc}$
	All	$I_{on/off}$	—	—	10	$\mu A$
Turn-On Delay and Rise Times ( $I_O=I_{O, max}$ , $V_{IN}=V_{IN, nom}$ , $T_A = 25^\circ C$ ) Case 1: On/Off input is set to Logic Low (Module ON) and then input power is applied ( $T_{delay}$ from instant at which $V_{IN} = V_{IN, min}$ until $V_O=10\%$ of $V_{O, set}$ ) Case 2: Input power is applied for at least 1 second and then the On/Off input is set from OFF to ON ( $T_{delay} =$ from instant at which $V_{IN}=V_{IN, min}$ until $V_O = 10\%$ of $V_{O, set}$ ). Output voltage Rise time (time for $V_O$ to rise from 10% of $V_{O, set}$ to 90% of $V_{O, set}$ ) Output voltage Rise time (time for $V_O$ to rise from 10% of $V_{O, set}$ to 90% of $V_{O, set}$ with max ext capacitance)	All	$T_{delay}$	—	10	20	msec
	B*	$T_{delay}$	—	25	30	msec
	All	$T_{delay}$	—	5	10	msec
	B*	$T_{delay}$	—	25	30	msec
	All	$T_{rise}$	—	8	12	msec
	All	$T_{rise}$	—	8	12	msec
Output voltage overshoot – Startup $I_O= I_{O, max}$ ; $V_{IN}=V_{IN, min}$ to $V_{IN, max}$ ; $T_A = 25^\circ C$	All			—	3	% $V_{O, set}$
Remote Sense Range (Max voltage drop is 0.5V)	G, Y, M, P, S1R0	$V_{SENSE}$			0.25	Vdc
	B*, A, F	$V_{SENSE}$			10	% $V_{O, set}$
Output Voltage Adjustment Range	All*		80		110	% $V_{O, set}$
Output Overvoltage Protection	B	$V_{O, limit}$	14	—	16	$V_{dc}$
	A	$V_{O, limit}$	5.7	—	6.5	$V_{dc}$
	F	$V_{O, limit}$	3.8	—	4.6	$V_{dc}$
	G	$V_{O, limit}$	2.9	—	3.4	$V_{dc}$
	Y	$V_{O, limit}$	2.3	—	2.6	$V_{dc}$
	M	$V_{O, limit}$	1.8	—	2.2	$V_{dc}$
	P	$V_{O, limit}$	1.4	—	1.6	$V_{dc}$
	S1R0	$V_{O, limit}$	1.2	—	1.4	$V_{dc}$
Input Undervoltage Lockout Turn-on Threshold Turn-off Threshold Hysteresis	All	$V_{UVLO}$	30 30 1.5	34.5 32 2	36 — —	$V_{dc}$ $V_{dc}$ $V_{dc}$
Input Overvoltage Lockout Turn-on Threshold Turn-off Threshold Hysteresis	All	$V_{OVLO}$	— 75 2	80 79 3.5	— 83 —	$V_{dc}$ $V_{dc}$ $V_{dc}$

\* Note: 12.0V<sub>O</sub> (B) device codes have an adaptable extended Turn-On Delay interval,  $T_{delay}$ , as specified for B\* devices. The extended  $T_{delay}$  will occur when a 12V<sub>O</sub> module restarts following either 1) the rapid cycling of  $V_{in}$  from normal levels to less than the Input Undervoltage Lockout and then back to normal; or 2) toggling the on/off signal from on to off and back to on without removing the input voltage. The normal Turn-On Delay interval,  $T_{delay}$ , as specified for All Devices, will occur whenever a 12V<sub>O</sub> module restarts with input voltage removed from the module for the preceding 1 second.

12.0V<sub>O</sub> (B) also achieves +10%  $V_{O, set}$  Remote Sense drop or trim up to 110%  $V_{O, set}$  only above  $V_{in} = 40V_{dc}$ .

### Characteristic Curves

The following figures provide typical characteristics for the EQW010A0B (12V, 10A) at 25°C. The figures are identical for either positive or negative remote On/Off logic.

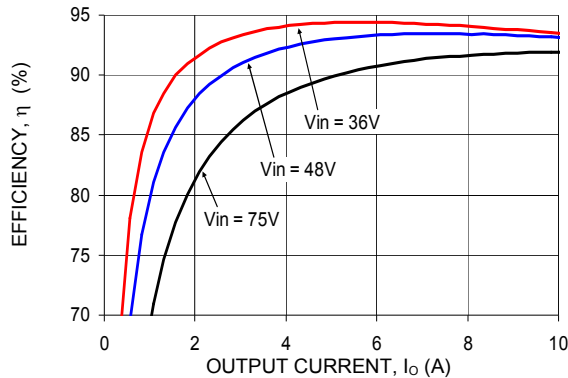

Figure 1. Converter Efficiency versus Output Current.

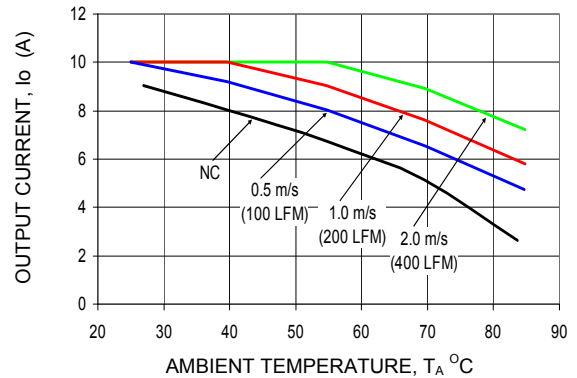

Figure 4. Derating Output Current versus Local Ambient Temperature and Airflow (direction shown in Figure 63).

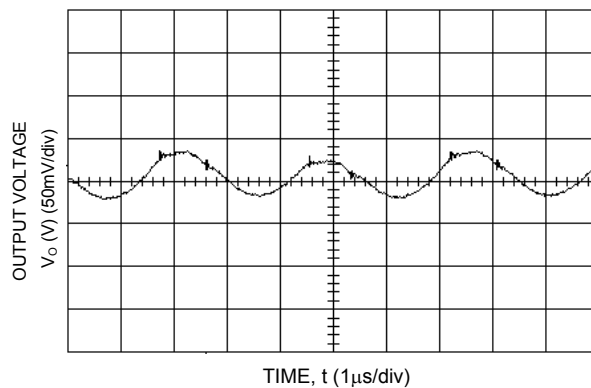

Figure 2. Typical output ripple and noise ( $V_{IN} = V_{IN,NOM}$ ,  $I_o = I_{o,max}$ ).

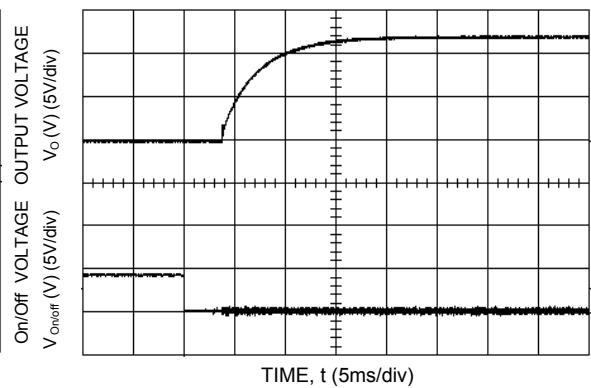

Figure 5. Typical Start-up using Remote On/Off, negative logic version, ( $V_{IN} = V_{IN,NOM}$ ,  $I_o = I_{o,max}$ ) [where input voltage has not been applied in the previous 1 second, see page 5].

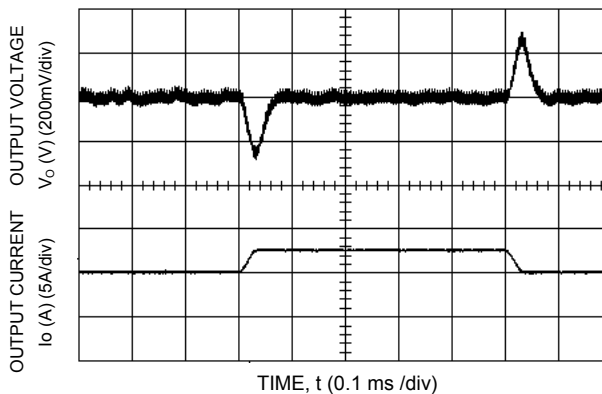

Figure 3. Transient Response to Dynamic Load Change from 75% to 50% to 75% of full load.

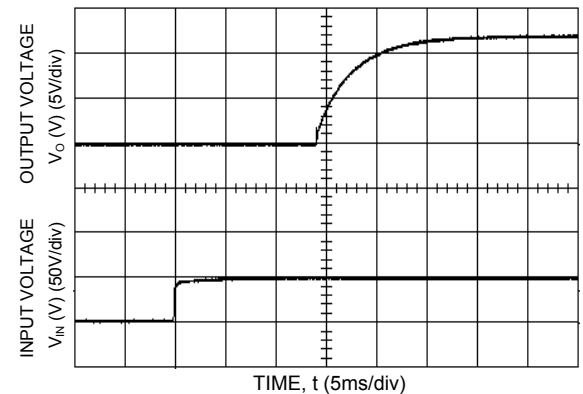

Figure 6. Typical Start-up Using Input Voltage, ( $V_{IN} = V_{IN,NOM}$ ,  $I_o = I_{o,max}$ ) [where input voltage has not been applied in the previous 1 second, see page 5].

Characteristic Curves

The following figures provide typical characteristics for the EQW020A0A (5.0V, 20A) at 25°C. The figures are identical for either positive or negative remote On/Off logic.

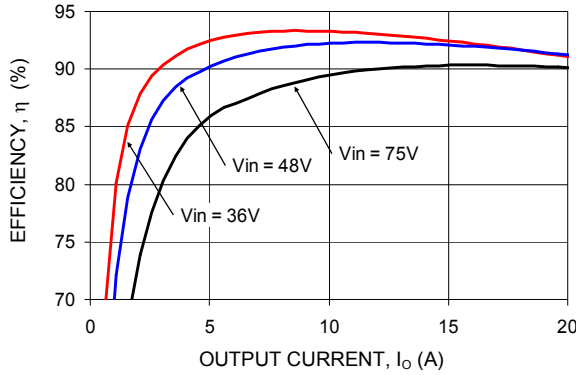

Figure 7. Converter Efficiency versus Output Current.

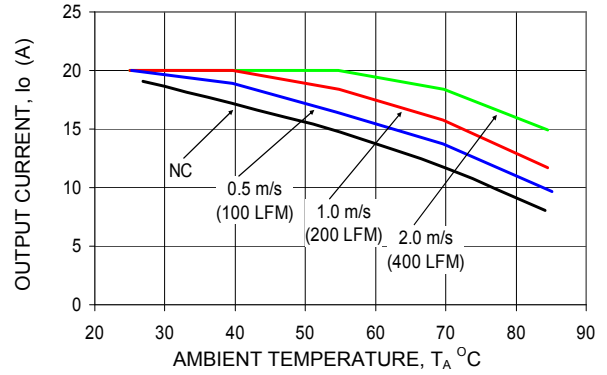

Figure 10. Derating Output Current versus Local Ambient Temperature and Airflow (direction shown in Figure 63).

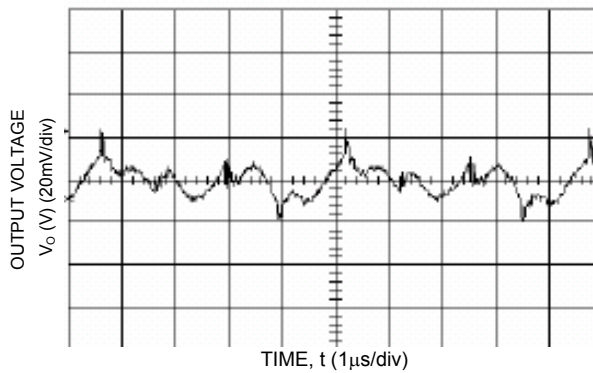

Figure 8. Typical output ripple and noise ( $V_{IN} = V_{IN,NOM}$ ,  $I_o = I_{o,max}$ ).

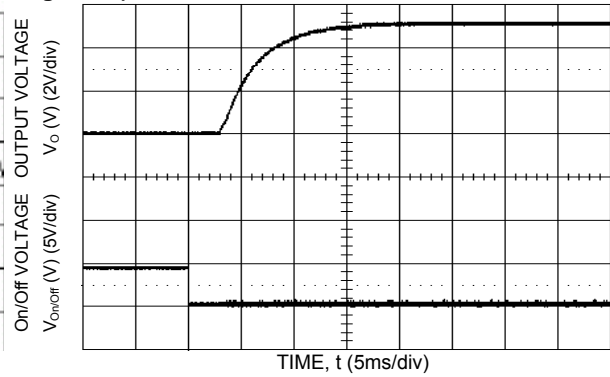

Figure 11. Typical Start-up Using Remote On/Off, negative logic version shown ( $V_{IN} = V_{IN,NOM}$ ,  $I_o = I_{o,max}$ ).

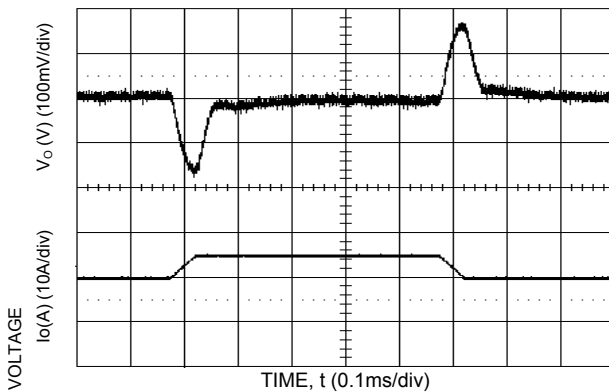

Figure 9. Transient Response to Dynamic Load Change from 50% to 75% to 50% of full load.

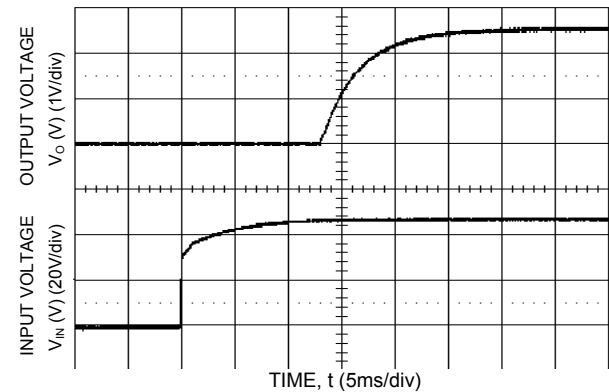

Figure 12. Typical Start-up Using Input Voltage ( $V_{IN} = V_{IN,NOM}$ ,  $I_o = I_{o,max}$ ).

Characteristic Curves (continued)

The following figures provide typical characteristics for the EQW030A0F (3.3V, 30A) at 25°C. The figures are identical for either positive or negative remote On/Off logic.

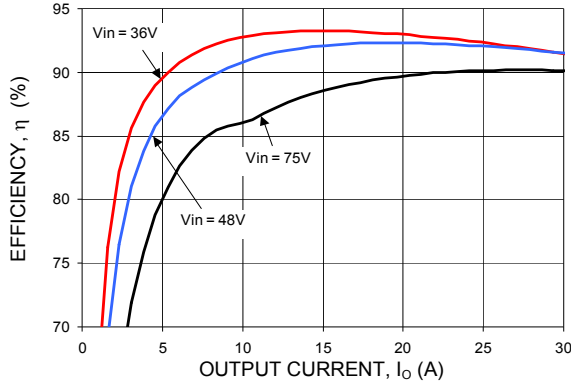

Figure 13. Converter Efficiency versus Output Current.

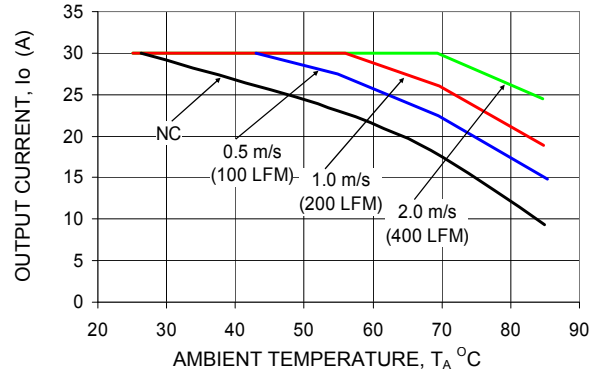

Figure 16. Derating Output Current versus Local Ambient Temperature and Airflow (direction shown in Figure 63).

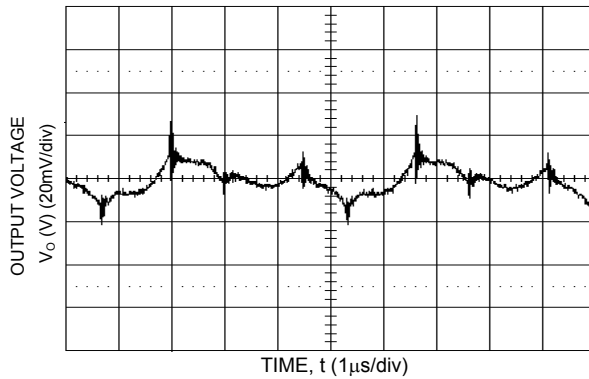

Figure 14. Typical output ripple and noise ( $V_{IN} = V_{IN,NOM}$ ,  $I_o = I_{o,max}$ ).

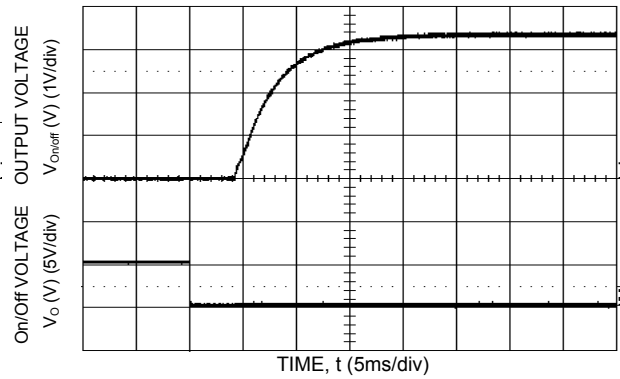

Figure 17. Typical Start-up Using Remote On/Off, negative logic version shown ( $V_{IN} = V_{IN,NOM}$ ,  $I_o = I_{o,max}$ ).

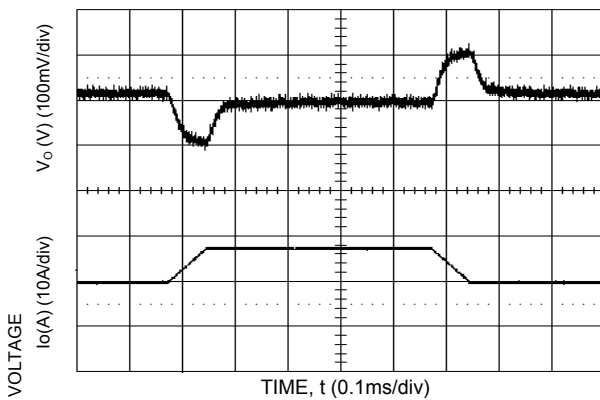

Figure 15. Transient Response to Dynamic Load Change from 50% to 75% to 50% of full load.

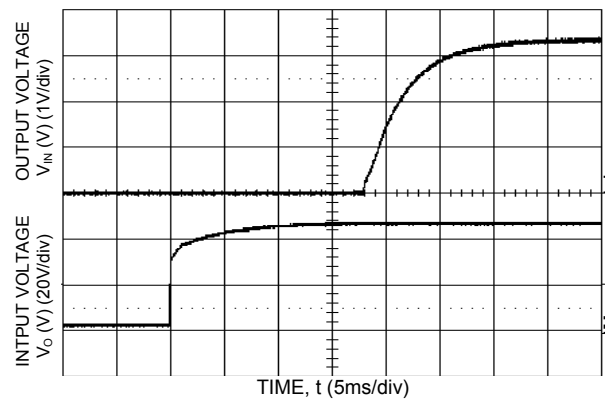

Figure 18. Typical Start-up Using Input Voltage ( $V_{IN} = V_{IN,NOM}$ ,  $I_o = I_{o,max}$ ).



Characteristic Curves (continued)

The following figures provide typical characteristics for the EQW035A0G (2.5V, 35A) at 25°C. The figures are identical for either positive or negative remote On/Off logic.

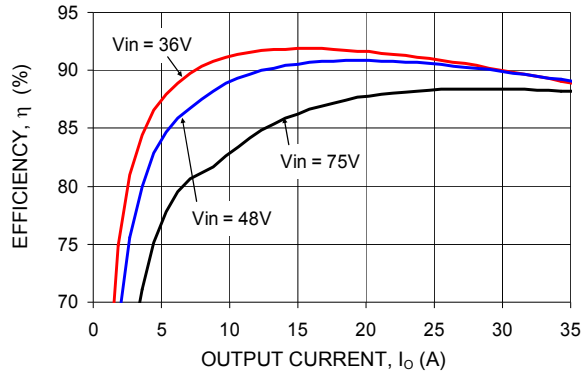

Figure 19. Converter Efficiency versus Output Current.

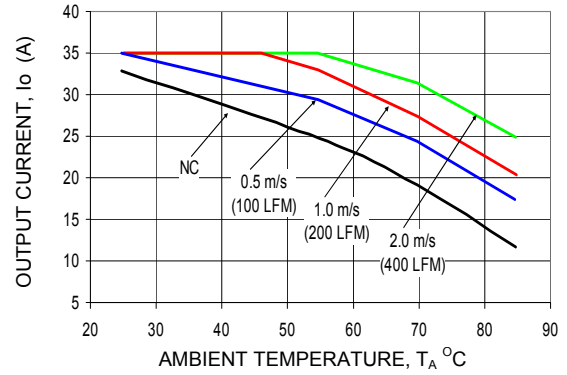

Figure 22. Derating Output Current versus Local Ambient Temperature and Airflow (direction shown in Figure 63).

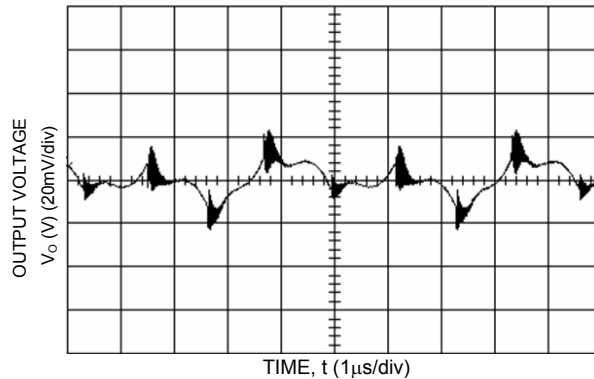

Figure 20. Typical output ripple and noise ( $V_{IN} = V_{IN,NOM}$ ,  $I_o = I_{o,max}$ ).

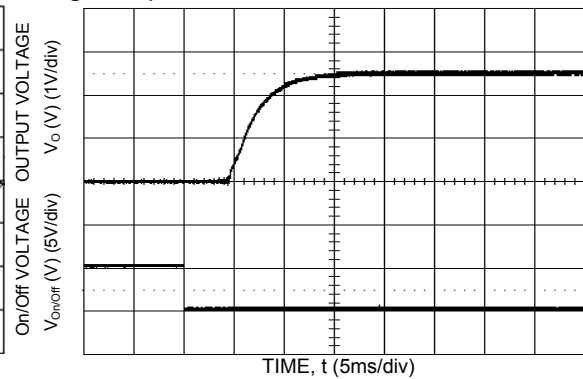

Figure 23. Typical Start-up Using Remote On/Off, negative logic version shown ( $V_{IN} = V_{IN,NOM}$ ,  $I_o = I_{o,max}$ ).

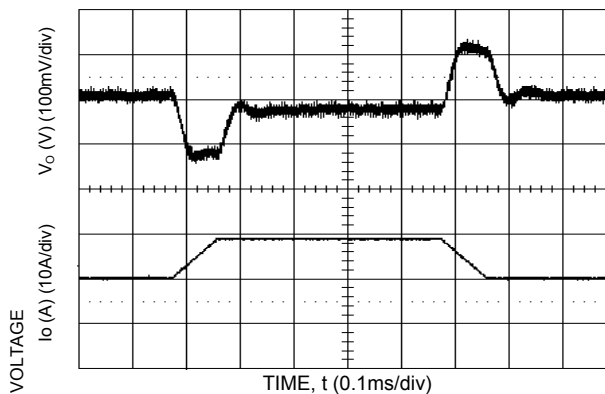

Figure 21. Transient Response to Dynamic Load Change from 50% to 75% to 50% of full load.

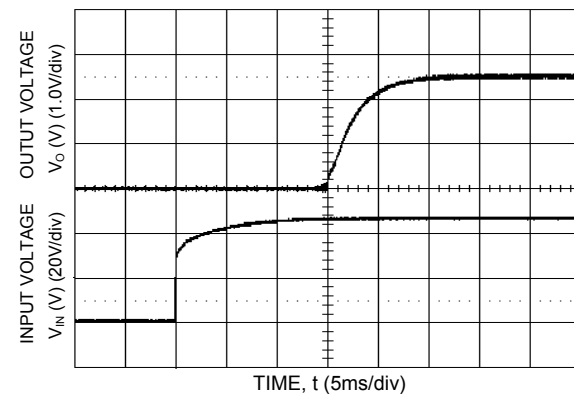

Figure 24. Typical Start-up Using Input Voltage ( $V_{IN} = V_{IN,NOM}$ ,  $I_o = I_{o,max}$ ).

Characteristic Curves (continued)

The following figures provide typical characteristics for the EQW040A0Y (1.8V, 40A) at 25°C. The figures are identical for either positive or negative remote On/Off logic.

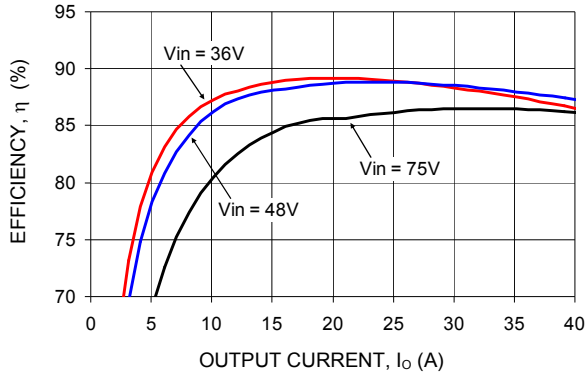

Figure 25. Converter Efficiency versus Output Current.

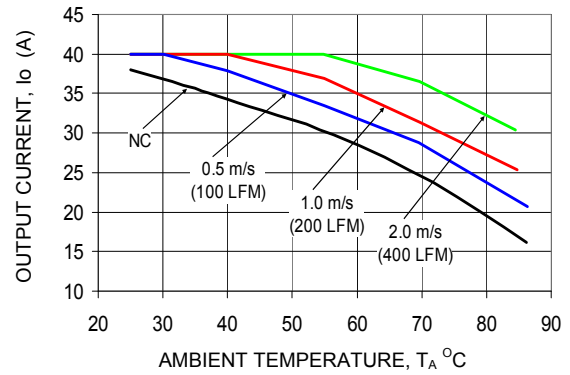

Figure 28. Derating Output Current versus Local Ambient Temperature and Airflow (direction shown in Figure 63).

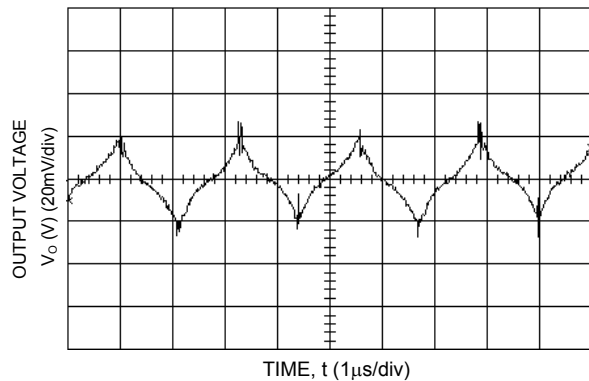

Figure 26. Typical output ripple and noise ( $V_{IN} = V_{IN,NOM}$ ,  $I_o = I_{o,max}$ ).

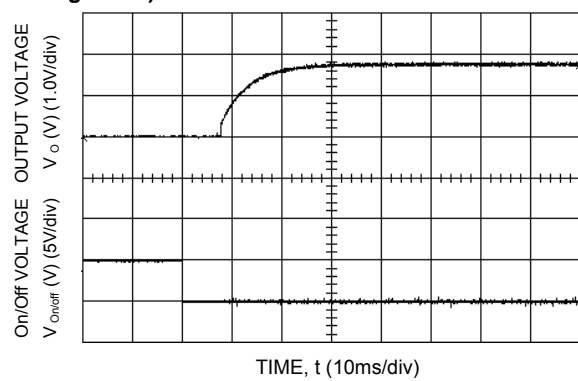

Figure 29. Typical Start-up Using Remote On/Off, negative logic version shown ( $V_{IN} = V_{IN,NOM}$ ,  $I_o = I_{o,max}$ ).

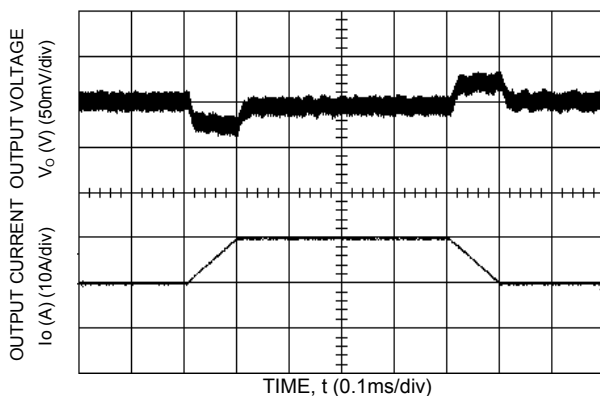

Figure 27. Transient Response to Dynamic Load Change from 50% to 75% to 50% of full load.

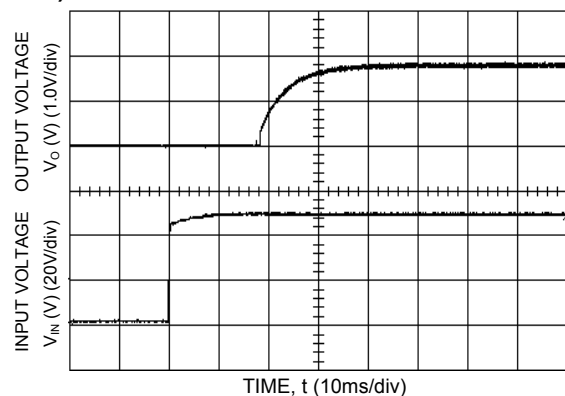

Figure 30. Typical Start-up Using Input Voltage ( $V_{IN} = V_{IN,NOM}$ ,  $I_o = I_{o,max}$ ).

Characteristic Curves (continued)

The following figures provide typical characteristics for the EQW040A0M (1.5V, 40A) at 25°C. The figures are identical for either positive or negative remote On/Off logic.

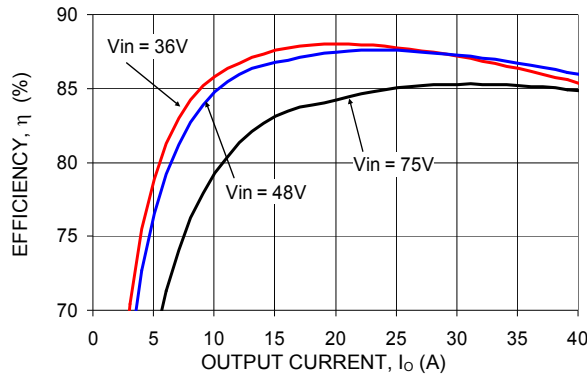

Figure 31. Converter Efficiency versus Output Current.

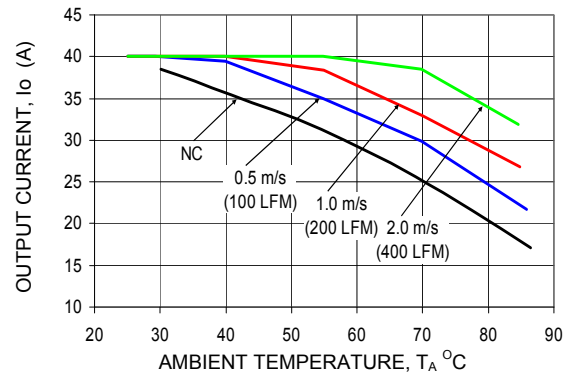

Figure 34. Derating Output Current versus Local Ambient Temperature and Airflow (direction shown in Figure 63).

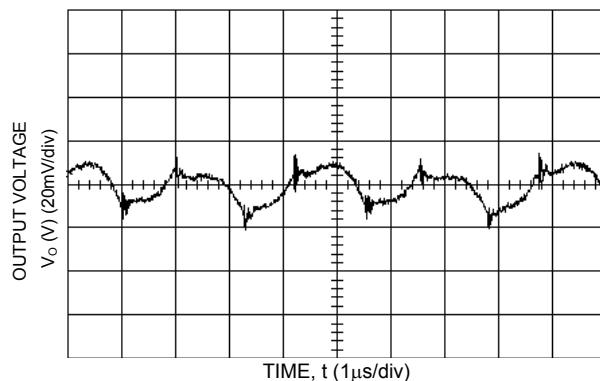

Figure 32. Typical output ripple and noise ( $V_{IN} = V_{IN,NOM}$ ,  $I_o = I_{o,max}$ ).

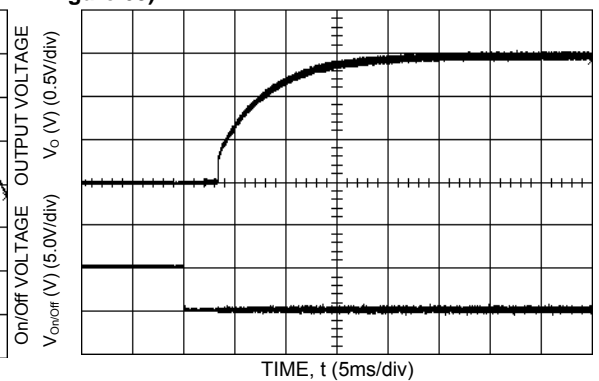

Figure 35. Typical Start-up Using Remote On/Off, negative logic version shown ( $V_{IN} = V_{IN,NOM}$ ,  $I_o = I_{o,max}$ ).

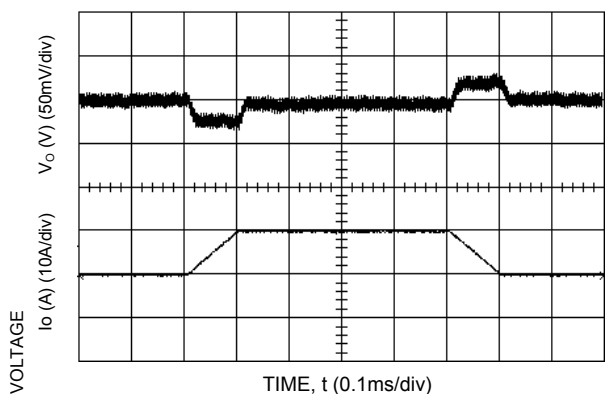

Figure 33. Transient Response to Dynamic Load Change from 50% to 75% to 50% of full load.

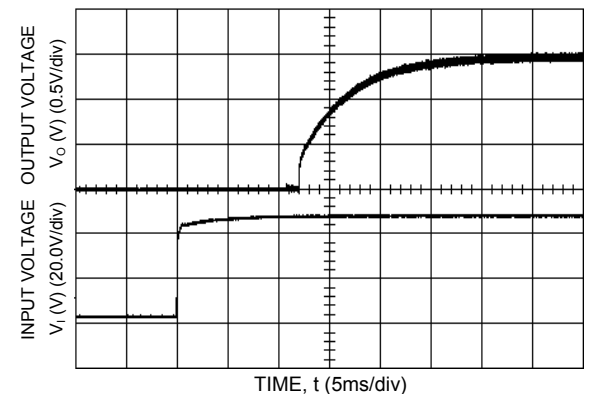

Figure 36. Typical Start-up Using Input Voltage ( $V_{IN} = V_{IN,NOM}$ ,  $I_o = I_{o,max}$ ).

Characteristic Curves (continued)

The following figures provide typical characteristics for the EQW040A0P (1.2V, 40A) at 25°C. The figures are identical for either positive or negative remote On/Off logic.

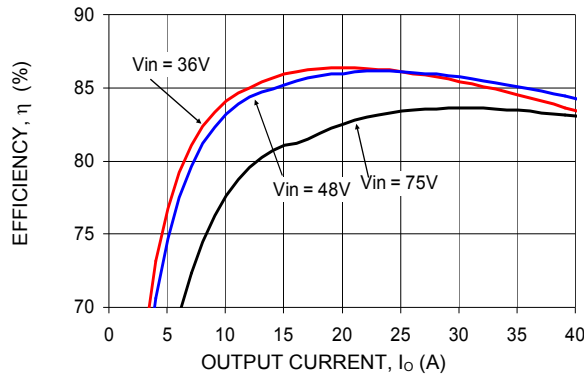

Figure 37. Converter Efficiency versus Output Current.

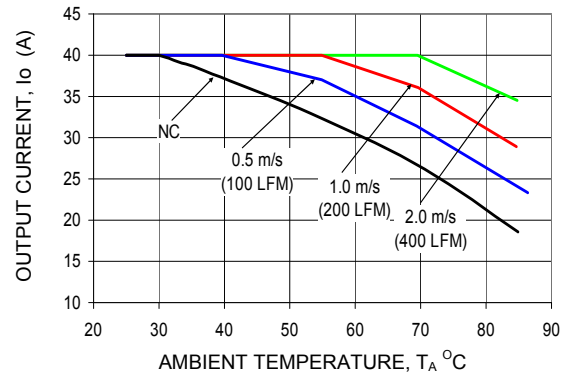

Figure 40. Derating Output Current versus Local Ambient Temperature and Airflow (direction shown in Figure 63).

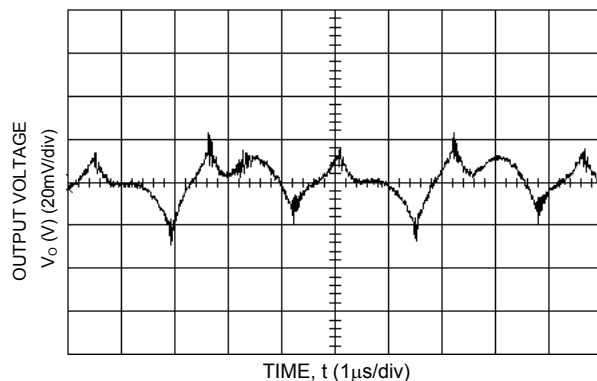

Figure 38. Typical output ripple and noise ( $V_{IN} = V_{IN,NOM}$ ,  $I_o = I_{o,max}$ ).

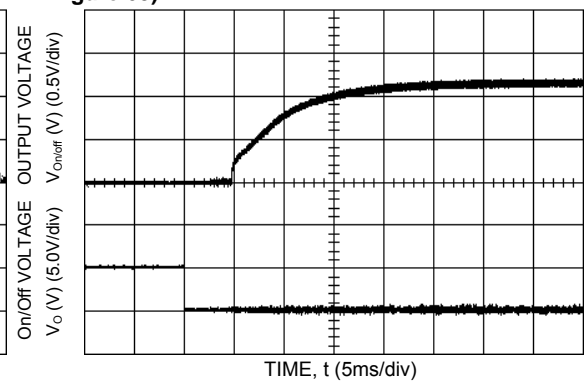

Figure 41. Typical Start-up Using Remote On/Off, negative logic version shown ( $V_{IN} = V_{IN,NOM}$ ,  $I_o = I_{o,max}$ ).

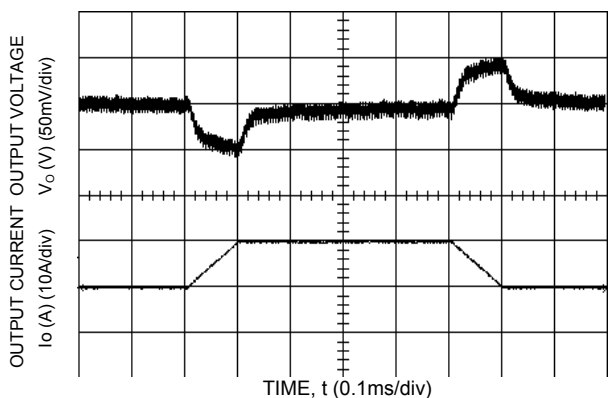

Figure 39. Transient Response to Dynamic Load Change from 50% to 75% to 50% of full load.

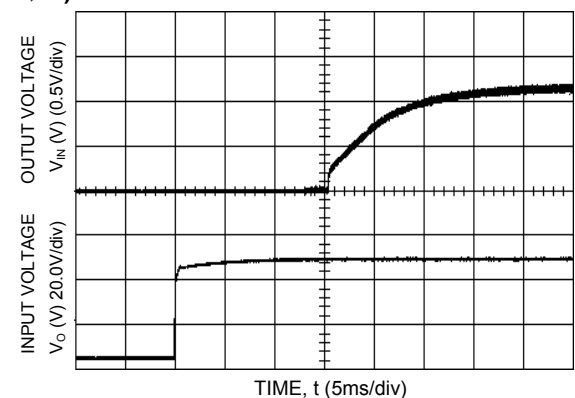

Figure 42. Typical Start-up Using Input Voltage ( $V_{IN} = V_{IN,NOM}$ ,  $I_o = I_{o,max}$ ).

Characteristic Curves (continued)

The following figures provide typical characteristics for the EQW040A0S1R0 (1.0V, 40A) at 25°C. The figures are identical for either positive or negative remote On/Off logic.

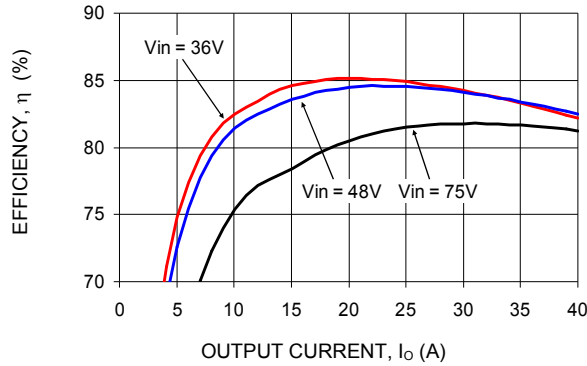

Figure 43. Converter Efficiency versus Output Current.

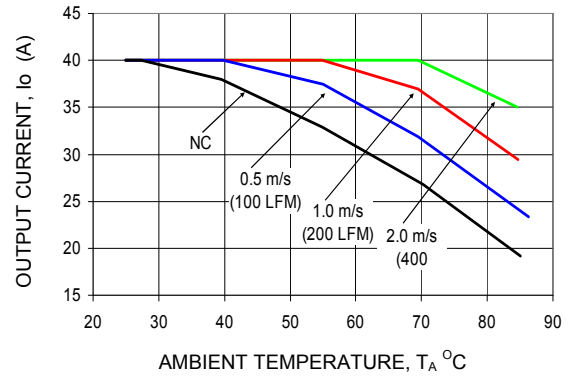

Figure 46. Derating Output Current versus Local Ambient Temperature and Airflow (direction shown in Figure 63).

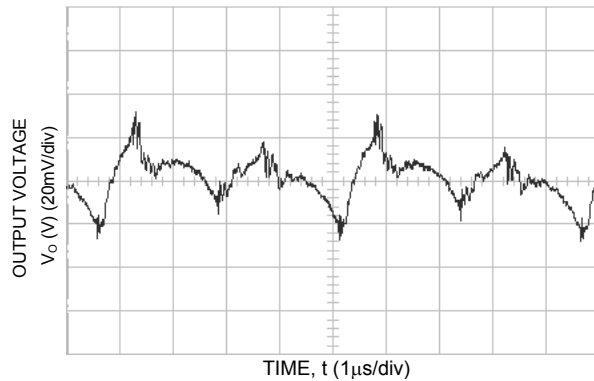

Figure 44. Typical output ripple and noise ( $V_{IN} = V_{IN,NOM}$ ,  $I_o = I_{o,max}$ ).

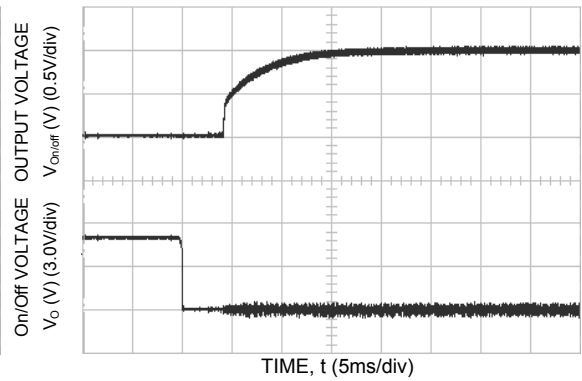

Figure 47. Typical Start-up Using Remote On/Off, negative logic version shown ( $V_{IN} = V_{IN,NOM}$ ,  $I_o = I_{o,max}$ ).

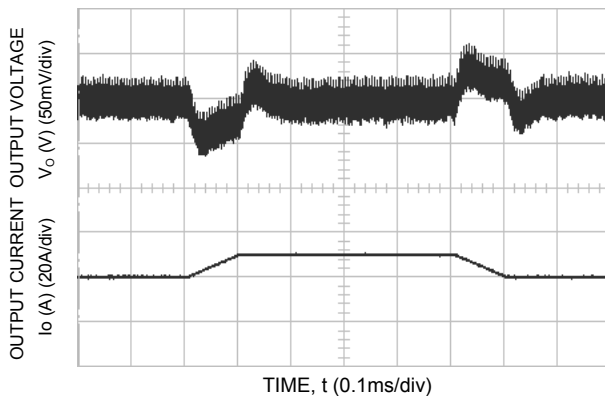

Figure 45. Transient Response to Dynamic Load Change from 50% to 75% to 50% of full load.

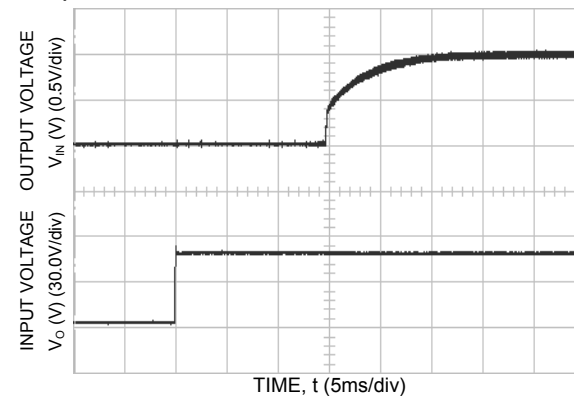

Figure 48. Typical Start-up Using Input Voltage ( $V_{IN} = V_{IN,NOM}$ ,  $I_o = I_{o,max}$ ).

Characteristic Curves (continued)

Derating Output Current versus Local Ambient Temperature and Airflow (direction shown in Figure 63) for heat plate versions (-C, -H).

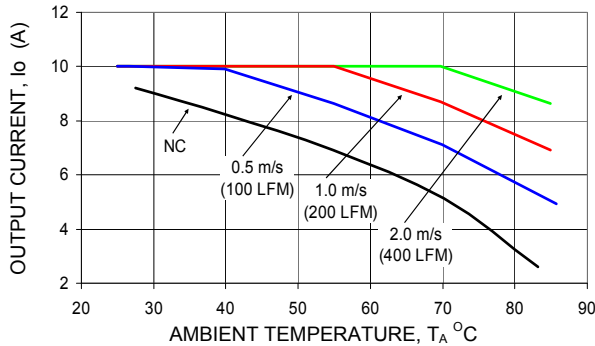

Figure 49. EQW010A0B-C/H, (12.0V, 10A).

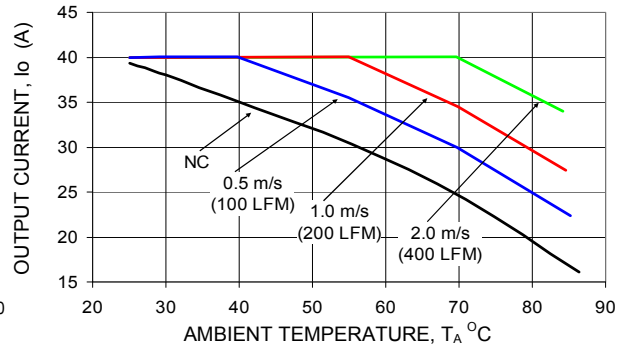

Figure 53. EQW040A0Y-C/H, (1.8V, 40A).

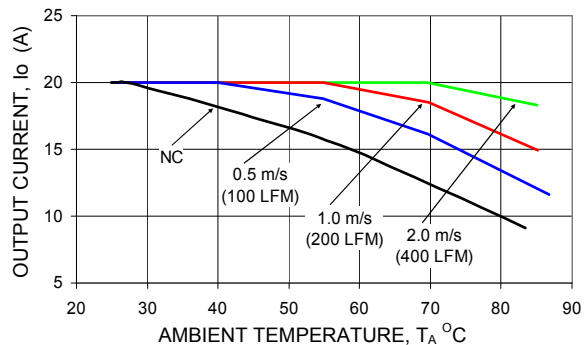

Figure 50. EQW020A0A-C/H, (5.0V, 20A).

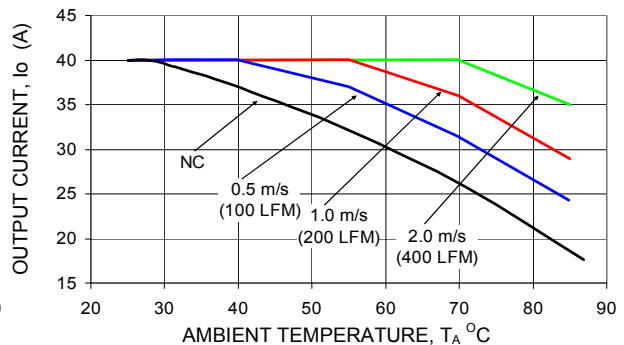

Figure 54. EQW040A0M-C/H, (1.5V, 40A).

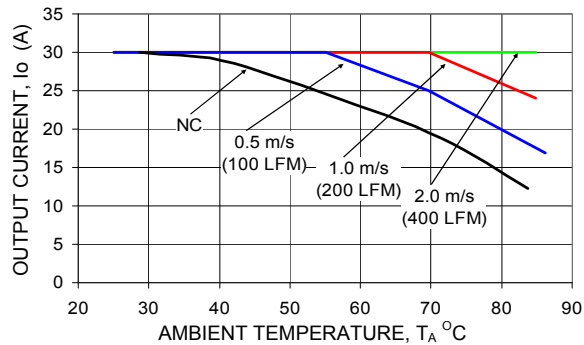

Figure 51. EQW030A0F-C/H, (3.3V, 30A).

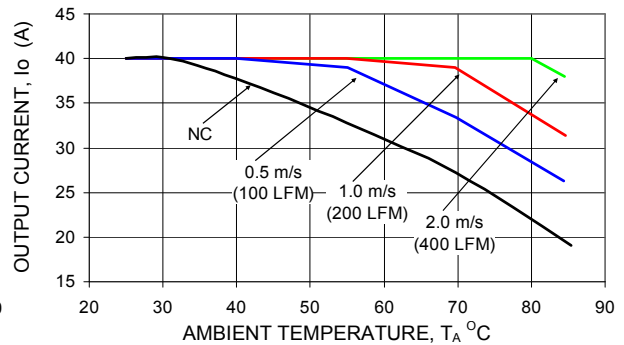

Figure 55. EQW040A0P-C/H, (1.2V, 40A).

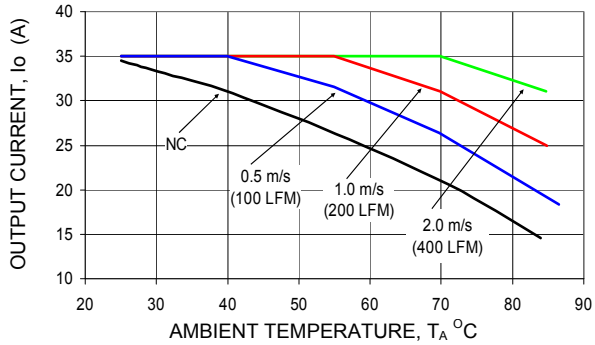

Figure 52. EQW035A0G-C/H, (2.5V, 35A).

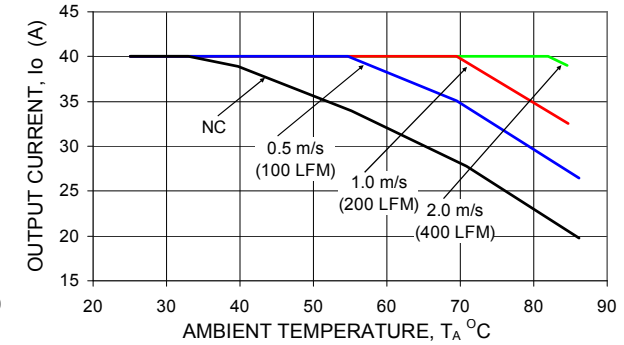
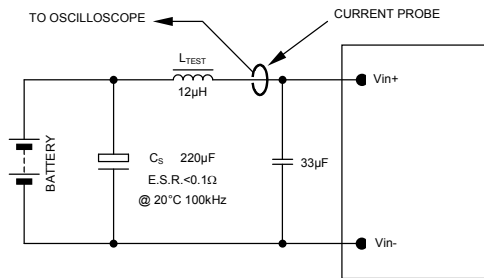

Figure 56. EQW040A0S-C/H, (1.0V, 40A).

## Test Configurations



NOTE: Measure input reflected ripple current with a simulated source inductance ( $L_{TEST}$ ) of 12µH. Capacitor  $C_S$  offsets possible battery impedance. Measure current as shown above.

Figure 57. Input Reflected Ripple Current Test Setup.

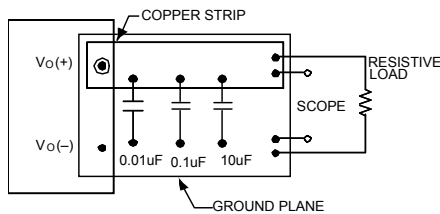

NOTE: All voltage measurements to be taken at the module terminals, as shown above. If sockets are used then Kelvin connections are required at the module terminals to avoid measurement errors due to socket contact resistance.

Figure 58. Output Ripple and Noise Test Setup.

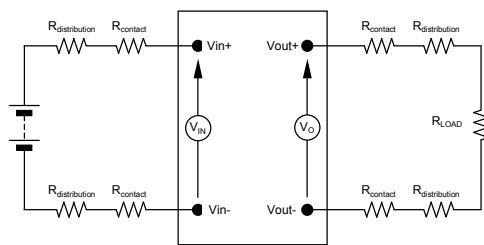

NOTE: All voltage measurements to be taken at the module terminals, as shown above. If sockets are used then Kelvin connections are required at the module terminals to avoid measurement errors due to socket contact resistance.

Figure 59. Output Voltage and Efficiency Test Setup.

$$\text{Efficiency } \eta = \frac{V_O \cdot I_O}{V_{IN} \cdot I_{IN}} \times 100 \%$$

## Design Considerations

### Input Filtering

The power module should be connected to a low ac-impedance source. Highly inductive source impedance can affect the stability of the power module. For the test configuration in Figure 57 a 33µF electrolytic capacitor (ESR<0.1Ω at 100kHz), mounted close to the power module helps ensure the stability of the unit. Consult the factory for further application guidelines.

### Output Filtering

For 1.0V to 1.2V output voltage modules, an external capacitance of 1000µF is recommended to achieve monotonic start-up with very light load ( $\leq 2\text{Amp}$ ).

### Safety Considerations

For safety-agency approval of the system in which the power module is used, the power module must be installed in compliance with the spacing and separation requirements of the end-use safety agency standard, i.e., UL 60950-1-3, CSA C22.2 No. 60950-00, and VDE 0805:2001-12 (IEC60950-1).

If the input source is non-SELV (ELV or a hazardous voltage greater than 60 Vdc and less than or equal to 75Vdc), for the module's output to be considered as meeting the requirements for safety extra-low voltage (SELV), all of the following must be true:

- The input source is to be provided with reinforced insulation from any other hazardous voltages, including the ac mains.
- One  $V_{IN}$  pin and one  $V_{OUT}$  pin are to be grounded, or both the input and output pins are to be kept floating.
- The input pins of the module are not operator accessible.
- Another SELV reliability test is conducted on the whole system (combination of supply source and subject module), as required by the safety agencies, to verify that under a single fault, hazardous voltages do not appear at the module's output.

**Note:** Do not ground either of the input pins of the module without grounding one of the output pins. This may allow a non-SELV voltage to appear between the output pins and ground.

The power module has extra-low voltage (ELV) outputs when all inputs are ELV.

All flammable materials used in the manufacturing of these modules are rated 94V-0, or tested to the UL60950 A.2 for reduced thickness.

For input voltages exceeding -60 Vdc but less than or equal to -75 Vdc, these converters have been evaluated to the applicable requirements of BASIC INSULATION between secondary DC MAINS DISTRIBUTION input (classified as TNV-2 in Europe) and unearthed SELV outputs.

The input to these units is to be provided with a maximum 8 A time-delay fuse in the ungrounded lead.

## Feature Description

### Remote On/Off

Two remote on/off options are available. Positive logic turns the module on during a logic high voltage on the ON/OFF pin, and off during a logic low. Negative logic remote On/Off, device code suffix "1", turns the module off during a logic high and on during a logic low.

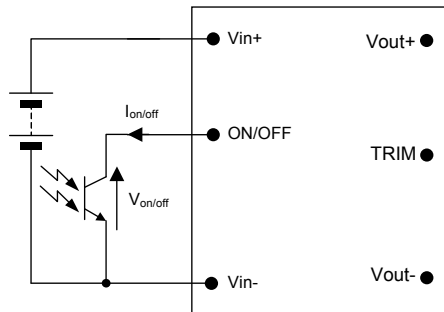

Figure 60. Remote On/Off Implementation.

To turn the power module on and off, the user must supply a switch (open collector or equivalent) to control the voltage ( $V_{on/off}$ ) between the ON/OFF terminal and the  $V_{IN(-)}$  terminal (see Figure 60). Logic low is  $0V \leq V_{on/off} \leq 1.2V$ . The maximum  $I_{on/off}$  during a logic low is 1mA, the switch should maintain a logic low level whilst sinking this current.

During a logic high, the typical maximum  $V_{on/off}$  generated by the module is 15V, and the maximum allowable leakage current at  $V_{on/off} = 5V$  is 1 $\mu$ A.

If not using the remote on/off feature:

For positive logic, leave the ON/OFF pin open.

For negative logic, short the ON/OFF pin to  $V_{IN(-)}$ .

### Remote Sense

Remote sense minimizes the effects of distribution losses by regulating the voltage at the remote-sense connections (See Figure 61). The voltage between the remote-sense pins and the output terminals must not exceed the output voltage sense range given in the Feature Specifications table:

$$[VO(+)-VO(-)] - [SENSE(+)-SENSE(-)] \leq 0.5 V$$

Although the output voltage can be increased by both the remote sense and by the trim, the maximum increase for the output voltage is not the sum of both. The maximum increase is the larger of either the remote sense or the trim.

The amount of power delivered by the module is defined as the voltage at the output terminals multiplied by the output current. When using remote sense and trim, the output voltage of the module can be increased, which at the same output current would increase the power output of the module. Care should

be taken to ensure that the maximum output power of the module remains at or below the maximum rated power (Maximum rated power =  $V_{o,set} \times I_{o,max}$ ).

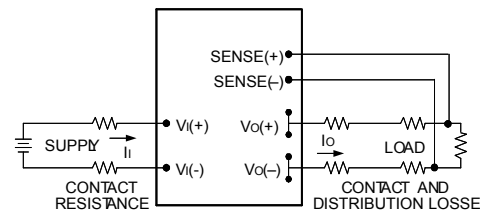

Figure 61. Circuit Configuration for remote sense .

### Input Undervoltage Lockout

At input voltages below the input undervoltage lockout limit, the module operation is disabled. The module will only begin to operate once the input voltage is raised above the undervoltage lockout turn-on threshold,  $V_{UV/ON}$ .

Once operating, the module will continue to operate until the input voltage is taken below the undervoltage turn-off threshold,  $V_{UV/OFF}$ .

### Overtemperature Protection

To provide protection under certain fault conditions, the unit is equipped with a thermal shutdown circuit. The unit will shutdown if the thermal reference point  $T_{ref}$  (Figure 63), exceeds 125°C (typical), but the thermal shutdown is not intended as a guarantee that the unit will survive temperatures beyond its rating. The module can be restarted by cycling the dc input power for at least one second or by toggling the remote on/off signal for at least one second. If the auto-restart option (4) is ordered, the module will automatically restart upon cool-down to a safe temperature.

### Output Overvoltage Protection

The output over voltage protection scheme of the modules has an independent over voltage loop to prevent single point of failure. This protection feature latches in the event of over voltage across the output. Cycling the on/off pin or input voltage resets the latching protection feature. If the auto-restart option (4) is ordered, the module will automatically restart upon an internally programmed time elapsing.

### Overcurrent Protection

To provide protection in a fault (output overload) condition, the unit is equipped with internal current-limiting circuitry and can endure current limiting continuously. At the point of current-limit inception, the unit enters hiccup mode. If the unit is not configured with auto-restart, then it will latch off



**Feature Descriptions** (continued)

following the over current condition. The module can be restarted by cycling the dc input power for at least one second or by toggling the remote on/off signal for at least one second. If the unit is configured with the auto-restart option (4), it will remain in the hiccup mode as long as the overcurrent condition exists; it operates normally, once the output current is brought back into its specified range. The average output current during hiccup is 10%  $I_{o, max}$ .

**Output Voltage Programming**

Trimming allows the output voltage set point to be increased or decreased, this is accomplished by connecting an external resistor between the TRIM pin and either the  $V_o(+)$  pin or the  $V_o(-)$  pin.

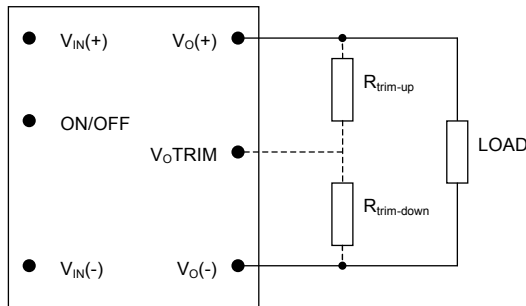

**Figure 62. Circuit Configuration to Trim Output Voltage.**

Connecting an external resistor ( $R_{trim-down}$ ) between the TRIM pin and the  $V_o(-)$  (or Sense(-)) pin decreases the output voltage set point. To maintain set point accuracy, the trim resistor tolerance should be  $\pm 1.0\%$ .

The following equation determines the required external resistor value to obtain a percentage output voltage change of  $\Delta\%$

**For output voltage: 1.0V to 12V**

$$R_{trim-down} = \left[ \frac{511}{\Delta\%} - 10.22 \right] K\Omega$$

Where  $\Delta\% = \left( \frac{V_{o,set} - V_{desired}}{V_{o,set}} \right) \times 100$

For example, to trim-down the output voltage of 2.5V module (EQW035A0G/G1) by 8% to 2.3V,  $R_{trim-down}$  is calculated as follows:

$$\Delta\% = 8$$

$$R_{trim-down} = \left[ \frac{511}{8} - 10.22 \right] K\Omega$$

$$R_{trim-down} = 53.655 K\Omega$$

Connecting an external resistor ( $R_{trim-up}$ ) between the TRIM pin and the  $V_o(+)$  (or Sense(+)) pin increases the output voltage set point. The following equations

determine the required external resistor value to obtain a percentage output voltage change of  $\Delta\%$ :

**For output voltage: 1.5V to 12V**

$$R_{trim-up} = \left[ \frac{5.11 \times V_{o,set} \times (100 + \Delta\%)}{1.225 \times \Delta\%} - \frac{511}{\Delta\%} - 10.22 \right] K\Omega$$

**For output voltage: 1.0V to 1.2V**

$$R_{trim-up} = \left[ \frac{5.11 \times V_{o,set} \times (100 + \Delta\%)}{0.6 \times \Delta\%} - \frac{511}{\Delta\%} - 10.22 \right] K\Omega$$

Where  $\Delta\% = \left( \frac{V_{desired} - V_{o,set}}{V_{o,set}} \right) \times 100$

For example, to trim-up the output voltage of 1.2V module (EQW040A0P/P1) by 5% to 1.26V,  $R_{trim-up}$  is calculated is as follows:

$$\Delta\% = 5$$

$$R_{trim-up} = \left[ \frac{5.11 \times 1.2 \times (100 + 5)}{0.6 \times 5} - \frac{511}{5} - 10.22 \right] K\Omega$$

$$R_{trim-up} = 102.2 K\Omega$$

**Alternative voltage programming for output voltage: 1.0V to 1.2V (-V Option)**

An alternative set of trimming equations is available as an option for 1.0V and 1.2V output modules, by ordering the -V option. These equations will reduce the resistance of the external programming resistor, making the impedance into the module trim pin lower for applications in high electrical noise applications.

$$R_{trim-down} = \left[ \frac{100}{\Delta\%} - 2 \right] K\Omega$$

$$R_{trim-up} = \left[ \frac{100}{\Delta\%} \right] K\Omega$$

Where  $\Delta\% = \left( \frac{V_{desired} - V_{o,set}}{V_{o,set}} \right) \times 100$

For example, to trim-up the output voltage of 1.2V module (EQW040A0P/P1-V) by 5% to 1.26V,  $R_{trim-up}$  is calculated is as follows:

$$\Delta\% = 5$$

$$R_{trim-up} = \left[ \frac{100}{5} \right] K\Omega$$

$$R_{trim-up} = 20.0 K\Omega$$

The value of the external trim resistor for the optional -V 1.2V module is only 20% of the value required with the standard trim equations.

## Feature Descriptions (continued)

The voltage between the Vo(+) and Vo(-) terminals must not exceed the minimum output overvoltage protection value shown in the Feature Specifications table. This limit includes any increase in voltage due to remote-sense compensation and output voltage set-point adjustment trim.

Although the output voltage can be increased by both the remote sense and by the trim, the maximum increase for the output voltage is not the sum of both. The maximum increase is the larger of either the remote sense or the trim. The amount of power delivered by the module is defined as the voltage at the output terminals multiplied by the output current. When using remote sense and trim, the output voltage of the module can be increased, which at the same output current would increase the power output of the module. Care should be taken to ensure that the maximum output power of the module remains at or below the maximum rated power (Maximum rated power =  $V_{o,set} \times I_{o,max}$ ).

## Thermal Considerations

The power modules operate in a variety of thermal environments; however, sufficient cooling should be provided to help ensure reliable operation.

Considerations include ambient temperature, airflow, module power dissipation, and the need for increased reliability. A reduction in the operating temperature of the module will result in an increase in reliability. The thermal data presented here is based on physical measurements taken in a wind tunnel.

The thermal reference point,  $T_{ref}$  used in the specifications for open frame modules is shown in Figure 63. For reliable operation this temperature should not exceed 120°C.

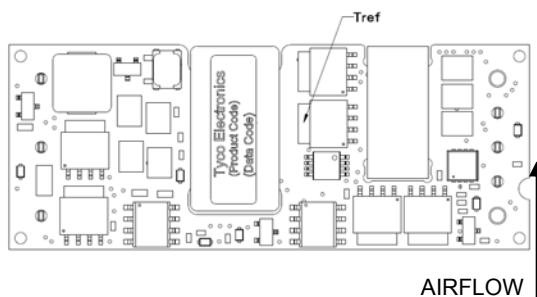

**Figure 63.  $T_{ref}$  Temperature Measurement Location for open Frame Module.**

The thermal reference point,  $T_{ref}$  used in the specifications for modules with heat plates (-C or -H) is shown in Figure 64. For reliable operation this temperature should not exceed 110°C for airflow rates below 1.0m/s (200LFM), and should not exceed 105°C for airflow rates equal to or above 1.0m/s (200LFM).

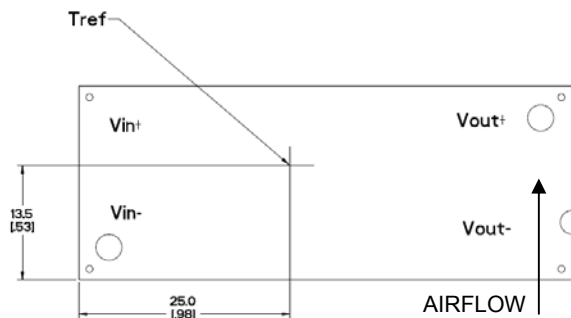

**Figure 64.  $T_{ref}$  Temperature Measurement Location for Heat plate Module.**

Please refer to the Application Note “Thermal Characterization Process For Open-Frame Board-Mounted Power Modules” for a detailed discussion of thermal aspects including maximum device temperatures.

## Through-Hole Soldering Information

The RoHS-compliant (Z codes) through-hole products use the SAC (Sn/Ag/Cu) Pb-free solder and RoHS-compliant components. The RoHS-compliant with lead solder exemption (non-Z codes) through-hole products use Sn/Pb solder and RoHS-compliant components. Both non-Z and Z codes are designed to be processed through single or dual wave soldering machines. The pins have an RoHS-compliant finish that is compatible with both Pb and Pb-free wave soldering processes. A maximum preheat rate of 3°C/s is suggested. The wave preheat process should be such that the temperature of the power module board is kept below 210°C. For Pb solder, the recommended pot temperature is 260°C, while the Pb-free solder pot is 270°C max. Not all RoHS-compliant through-hole products can be processed with paste-through-hole Pb or Pb-free reflow process. If additional information is needed, please consult with your Lineage Power representative for more details.

## Surface Mount Information

### Pick and Place

The EQW010-040 modules use an open frame construction and are designed for a fully automated assembly process. The modules are fitted with a label designed to provide a large surface area for pick and place operations. The label meets all the requirements for surface mount processing, as well as safety standards, and is able to withstand reflow temperatures of up to 300°C. The label also carries product information such as product code, serial number and the location of manufacture.

**Surface Mount Information (continued)**

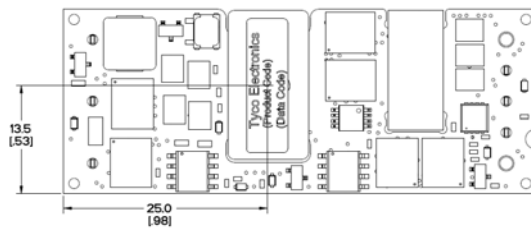

**Figure 65. Pick and Place Location.**

**Nozzle Recommendations**

The module weight has been kept to a minimum by using open frame construction. Even so, these modules have a relatively large mass when compared to conventional SMT components. Variables such as nozzle size, tip style, vacuum pressure and placement speed should be considered to optimize this process. The minimum recommended nozzle diameter for reliable operation is 6mm. The maximum nozzle outer diameter, which will safely fit within the allowable component spacing, is 9 mm.

Oblong or oval nozzles up to 11 x 9 mm may also be used within the space available.

**Reflow Soldering Information**

The surface mountable modules in the EQW family use our newest SMT technology called “Column Pin” (CP) connectors. Figure 66 shows the new CP connector before and after reflow soldering onto the end-board assembly.

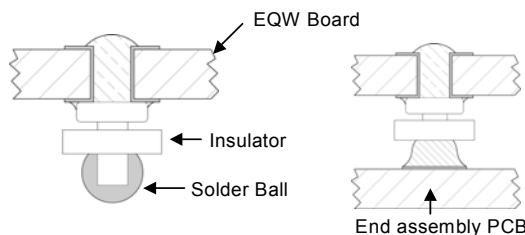

**Figure 66. Column Pin Connector Before and After Reflow Soldering.**

The CP is constructed from a solid copper pin with an integral solder ball attached, which is composed of tin/lead (Sn<sub>63</sub>/Pb<sub>37</sub>) solder for non-Z codes, or Sn/Ag<sub>3.8</sub>/Cu<sub>0.7</sub> (SAC) solder for -Z codes. The CP connector design is able to compensate for large amounts of co-planarity and still ensure a reliable SMT solder joint. Typically, the eutectic solder melts at 183°C (Sn/Pb solder) or 217-218 °C (SAC solder), wets the land, and subsequently wicks the device connection. Sufficient time must be allowed to fuse the plating on the connection to ensure a reliable solder joint. There are several types of SMT reflow

technologies currently used in the industry. These surface mount power modules can be reliably soldered using natural forced convection, IR (radiant infrared), or a combination of convection/IR.

The following instructions must be observed when SMT soldering these units. Failure to observe these instructions may result in the failure of or cause damage to the modules, and can adversely affect long-term reliability.

**Tin Lead Soldering**

The recommended linear reflow profile using Sn/Pb solder is shown in Figure 67 and 68. For reliable soldering the solder reflow profile should be established by accurately measuring the modules CP connector temperatures.

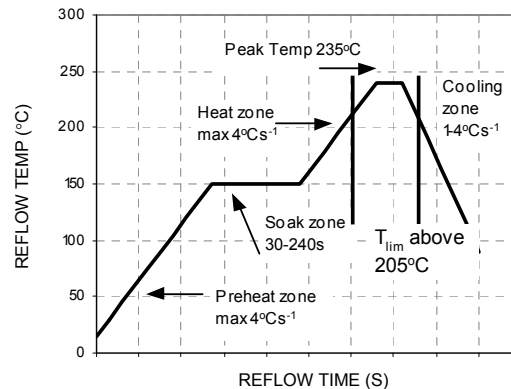

**Figure 67. Recommended Reflow Profile for Tin/Lead (Sn/Pb) process.**

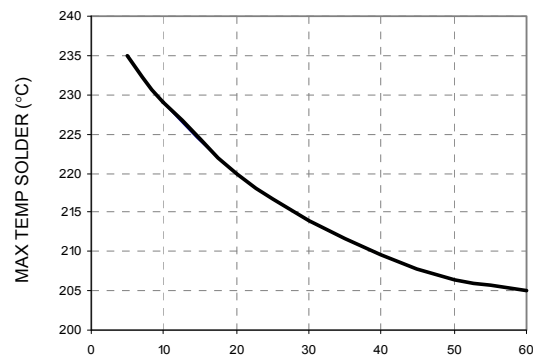

**Figure 68. Time Limit, T<sub>lim</sub>, Curve Above 205°C for Tin/Lead (Sn/Pb) process.**

## Surface Mount Information (continued)

### Lead Free Soldering

The –Z version of the EQW010-040 modules are lead-free (Pb-free) and RoHS compliant and are both forward and backward compatible in a Pb-free and a SnPb soldering process. Failure to observe the instructions below may result in the failure of or cause damage to the modules and can adversely affect long-term reliability.

### Pb-free Reflow Profile

Power Systems will comply with J-STD-020 Rev. C (Moisture/Reflow Sensitivity Classification for Nonhermetic Solid State Surface Mount Devices) for both Pb-free solder profiles and MSL classification procedures. This standard provides a recommended forced-air-convection reflow profile based on the volume and thickness of the package (table 4-2). The suggested Pb-free solder paste is Sn/Ag/Cu (SAC). The recommended linear reflow profile using Sn/Ag/Cu solder is shown in Fig. 69.

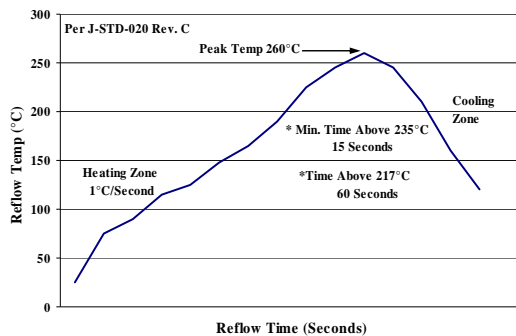

Figure 69. Recommended linear reflow profile using Sn/Ag/Cu solder.

### MSL Rating

The EQW010-040 modules have a MSL rating of 1.

### Storage and Handling

The recommended storage environment and handling procedures for moisture-sensitive surface mount packages is detailed in J-STD-033 Rev. A (Handling, Packing, Shipping and Use of Moisture/Reflow Sensitive Surface Mount Devices). Moisture barrier bags (MBB) with desiccant are required for MSL ratings of 2 or greater. These sealed packages should not be broken until time of use. Once the original package is broken, the floor life of the product at conditions of  $\leq 30^{\circ}\text{C}$  and 60% relative humidity varies according to the MSL rating (see J-STD-033A). The shelf life for dry packed SMT packages will be a minimum of 12 months from the bag seal date, when stored at the following conditions:  $< 40^{\circ}\text{C}$ ,  $< 90\%$  relative humidity.

### Post Solder Cleaning and Drying Considerations

Post solder cleaning is usually the final circuit-board assembly process prior to electrical board testing. The result of inadequate cleaning and drying can affect both the reliability of a power module and the testability of the finished circuit-board assembly. For guidance on appropriate soldering, cleaning and drying procedures, refer to Lineage Power *Board Mounted Power Modules: Soldering and Cleaning* Application Note (AN04-001).

**Mechanical Outline for Surface Mount Module**

Dimensions are in millimeters and [inches].

Tolerances: x.x mm ± 0.5 mm [x.xx in. ± 0.02 in.] (Unless otherwise indicated)

x.xx mm ± 0.25 mm [x.xxx in ± 0.010 in.]

#Top side label includes Lineage Power name, product designation and date code.

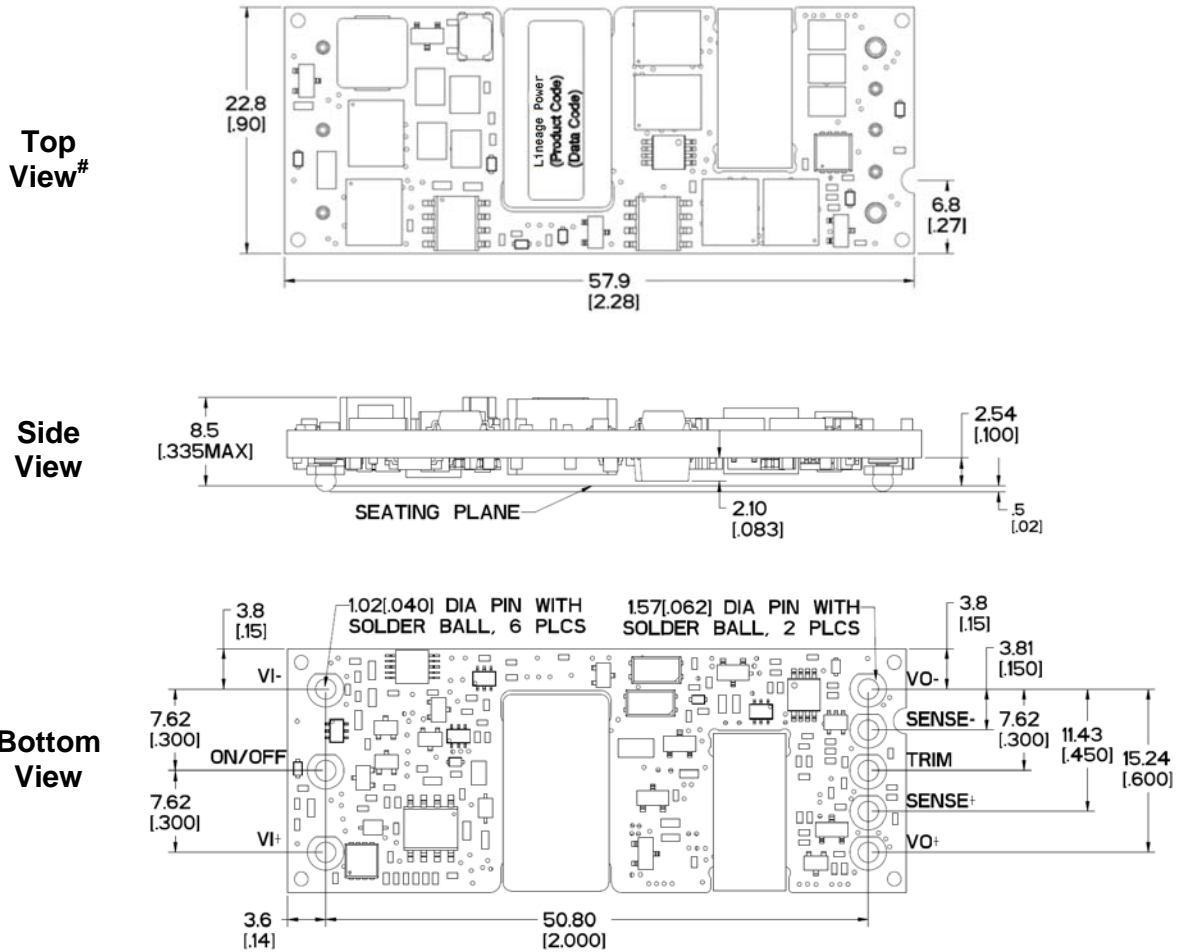

**Mechanical Outline for Through-Hole Module**

Dimensions are in millimeters and [inches].

Tolerances: x.x mm ± 0.5 mm [x.xx in. ± 0.02 in.] (Unless otherwise indicated)

x.xx mm ± 0.25 mm [x.xxx in ± 0.010 in.]

#Top side label includes Lineage Power name, product designation and date code.

**Top View#**

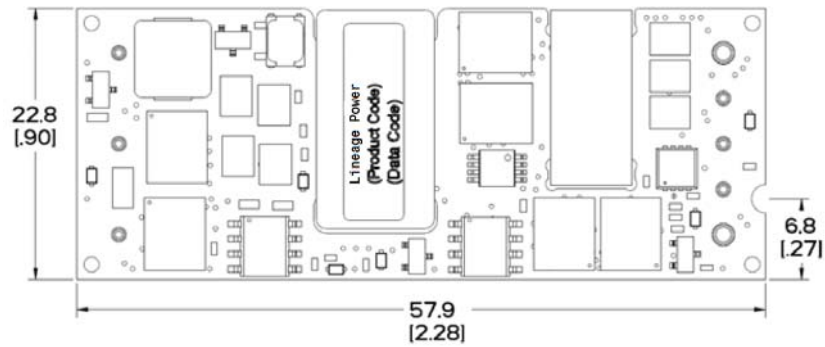

**Side View**

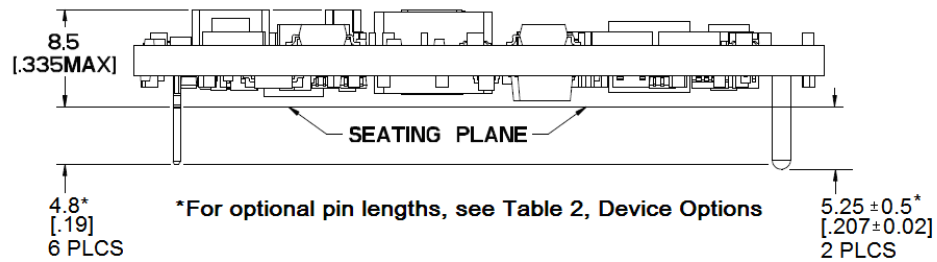

**Bottom View**

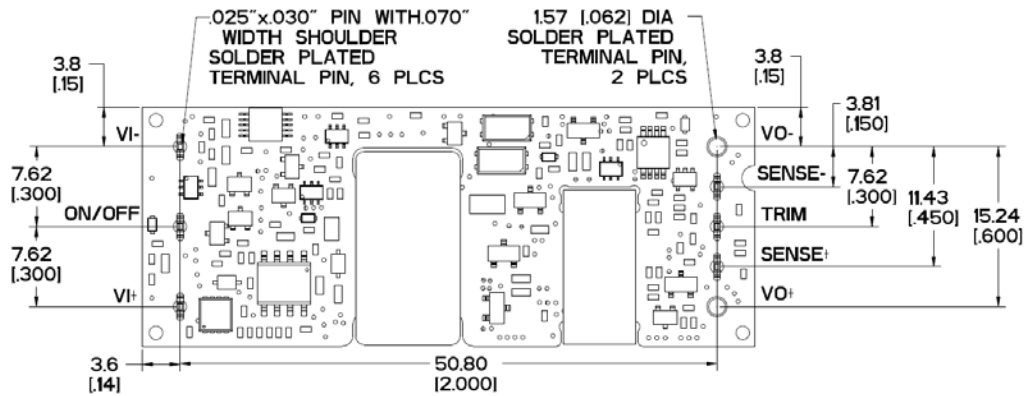

**Mechanical Outline for Through-Hole Module with Heat Plate (-C)**

Dimensions are in millimeters and [inches].

Tolerances: x.x mm ± 0.5 mm [x.xx in. ± 0.02 in.] (Unless otherwise indicated)

x.xx mm ± 0.25 mm [x.xxx in ± 0.010 in.]

**Top View**

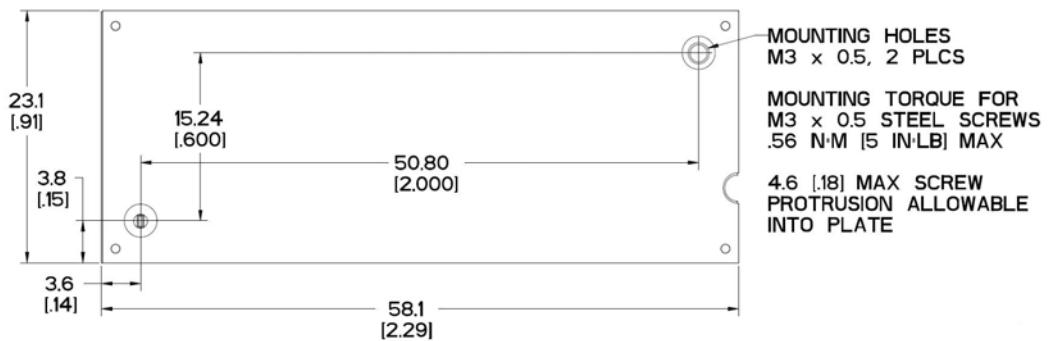

**Side View**

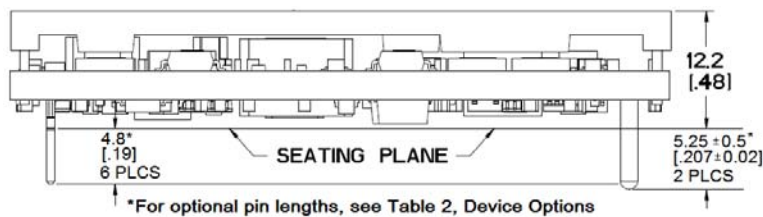

# Bottom side label includes Lineage Power name, product designation and date code.

**Bottom View#**

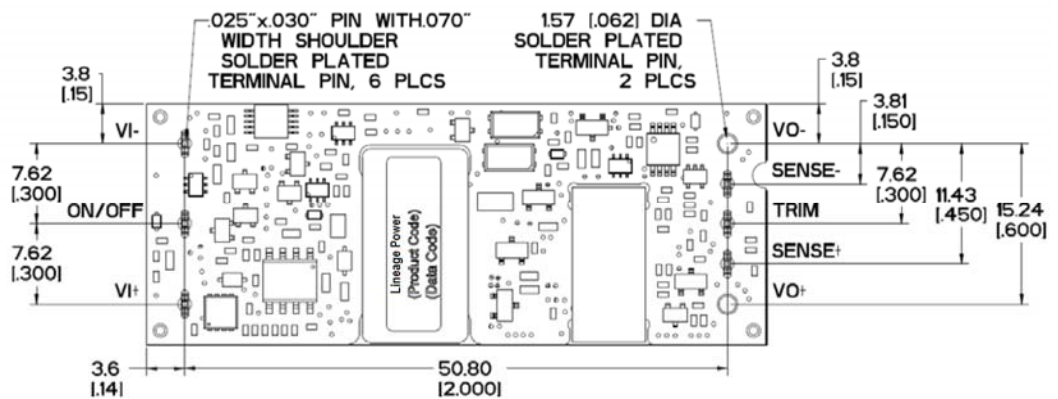



**Mechanical Outline for Through-Hole Module with Heat Plate (-H)**

Dimensions are in millimeters and [inches].

Tolerances: x.xx mm ± 0.5 mm [x.xx in. ± 0.02 in.] (Unless otherwise indicated)

x.xx mm ± 0.25 mm [x.xxx in ± 0.010 in.]

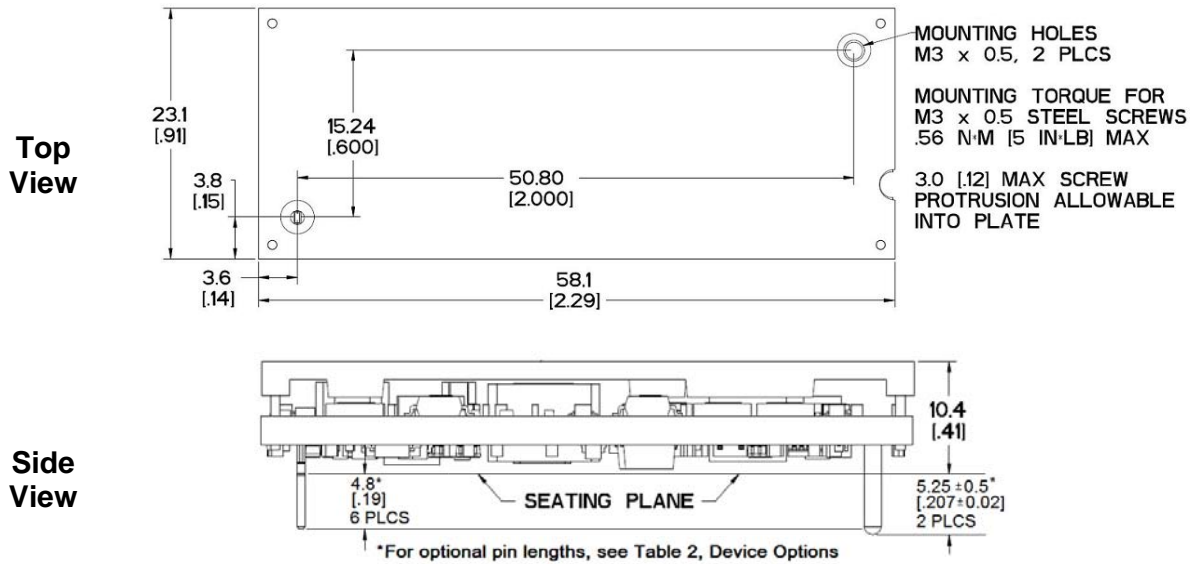

# Bottom side label includes Lineage Power name, product designation and date code.

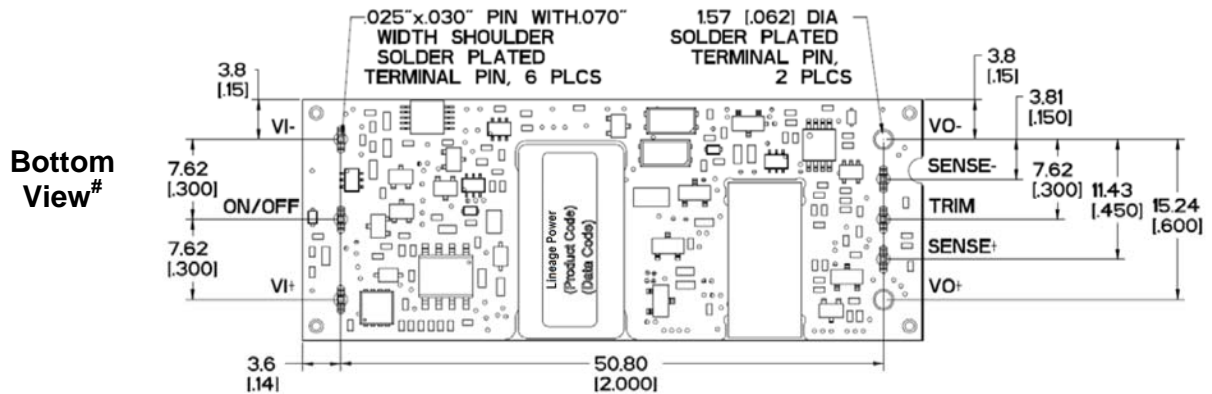



### Recommended Pad Layout

Dimensions are in millimeters and [inches].

Tolerances: x.x mm ± 0.5 mm [x.xx in. ± 0.02 in.] (Unless otherwise indicated)

x.xx mm ± 0.25 mm [x.xxx in. ± 0.010 in.]

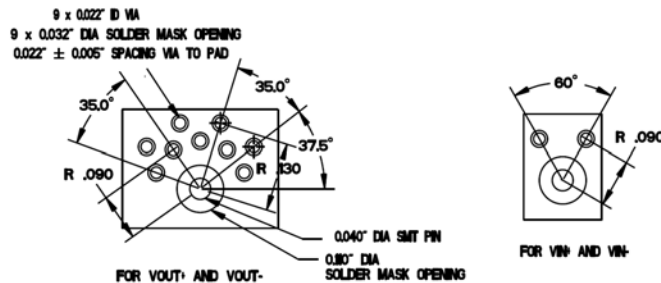
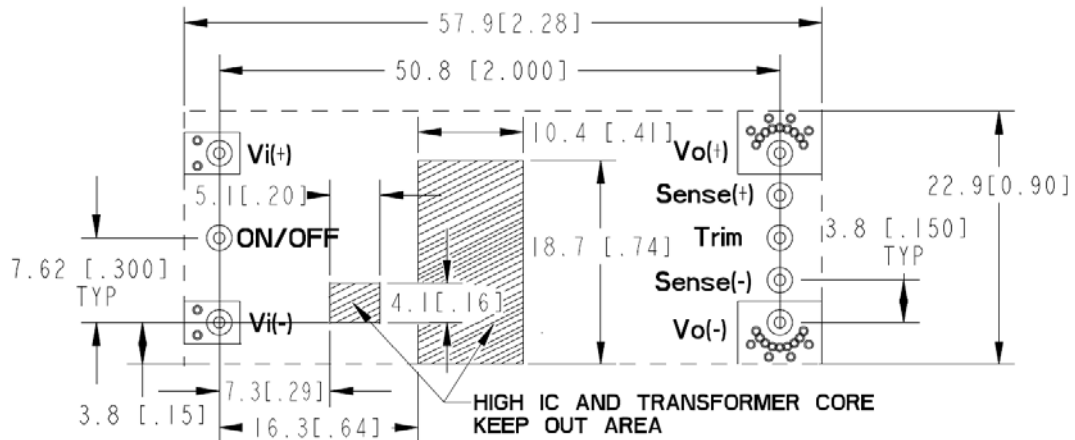

### SMT Recommended Pad Layout (Component Side View)

Component Side View

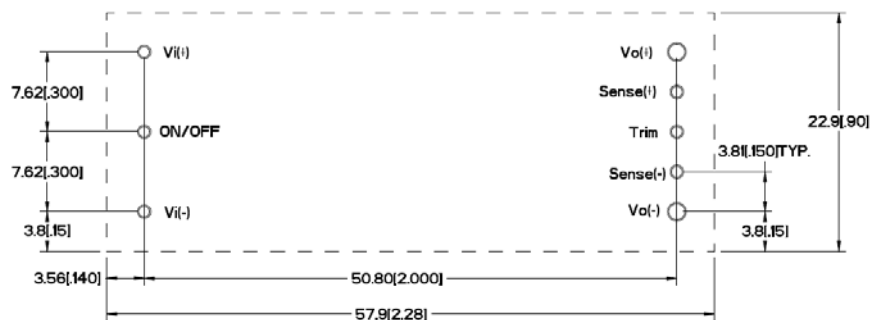

- NOTES:
1. FOR 0.030"x0.025" PIN  
USE 0.050" DIA PLATED THROUGH HOLE
  2. FOR 0.060" DIA PIN  
USE 0.076" DIA PLATED THROUGH HOLE

### TH Recommended Pad Layout (Component Side View)

**Packaging Details**

The surface mount versions of the EQW surface mount modules (suffix -S) are supplied as standard in the plastic tray shown in Figure 68. The tray has external dimensions of 135.1mm (W) x 321.8mm (L) x 12.42mm (H) or 5.319in (W) x 12.669in (L) x 0.489in (H).

**Tray Specification**

Material	Antistatic coated PVC
Max surface resistivity	10 <sup>12</sup> Ω/sq
Color	Clear
Capacity	12 power modules
Min order quantity	48 pcs (1 box of 4 full trays)

Each tray contains a total of 12 power modules. The trays are self-stacking and each shipping box will contain 4 full trays plus one empty hold down tray giving a total number of 48 power modules.

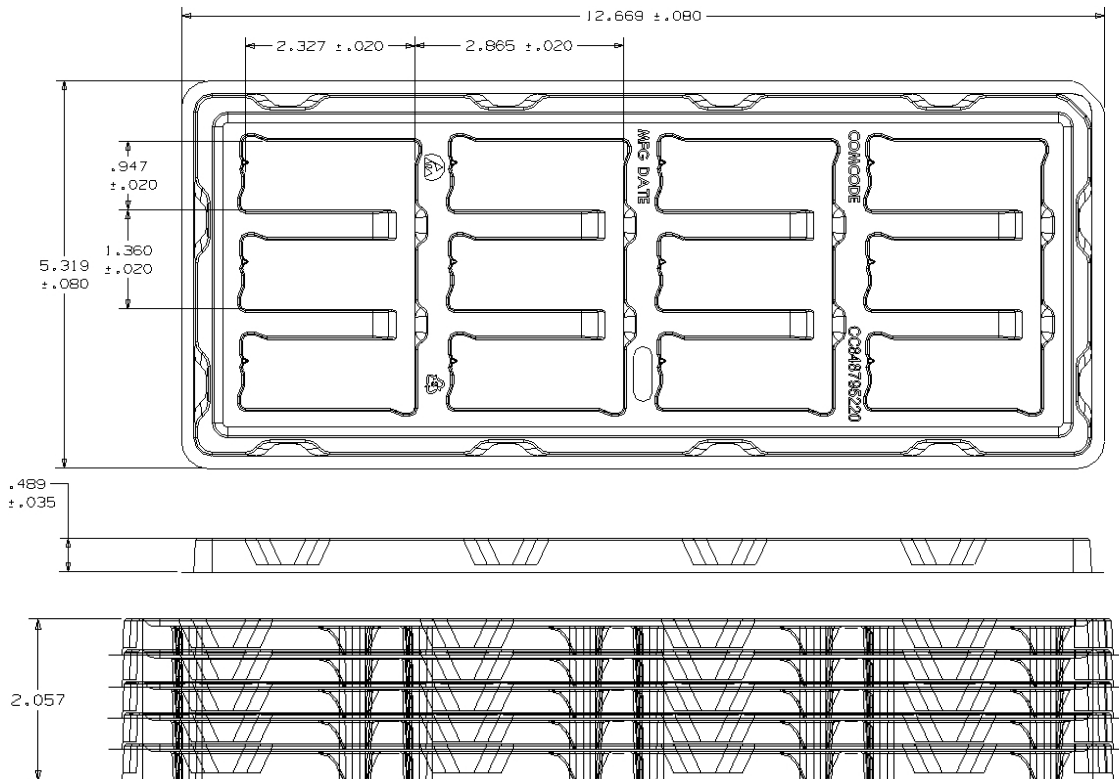

Figure 68. Surface Mount Packaging Tray.

## Ordering Information

Please contact your Lineage Power Sales Representative for pricing, availability and optional features.

**Table 1. Device Codes**

Product Codes	Input Voltage	Output Voltage	Output Current	On/Off Logic	Connector Type	Comcodes
EQW010A0B1	48V (36-75Vdc)	12V	10A	Negative	Through hole	108997284
EQW020A0A41-SB	48V (36-75Vdc)	5V	20A	Negative	Surface Mount	CC109103966
EQW030A0F1	48V (36-75Vdc)	3.3V	30A	Negative	Through hole	108996096
EQW010A0BZ	48V (36-75Vdc)	12V	10A	Positive	Through hole	CC109129152
EQW010A0B1Z	48V (36-75Vdc)	12V	10A	Negative	Through hole	CC109114823
EQW010A0B641Z	48V (36-75Vdc)	12V	10A	Negative	Through hole	CC109122116
EQW010A0B4-CZ	48V (36-75Vdc)	12V	10A	Positive	Through hole	CC109146404
EQW010A0B41-CZ	48V (36-75Vdc)	12V	10A	Negative	Through hole	CC109135043
EQW010A0B1-HZ	48V (36-75Vdc)	12V	10A	Negative	Through hole	CC109122207
EQW010A0B1-SZ	48V (36-75Vdc)	12V	10A	Negative	Surface Mount	CC109114641
EQW010A0B41-SZ	48V (36-75Vdc)	12V	10A	Negative	Surface Mount	CC109127957
EQW020A0A1Z	48V (36-75Vdc)	5V	20A	Negative	Through hole	CC109114402
EQW020A0A61Z	48V (36-75Vdc)	5V	20A	Negative	Through hole	CC109132701
EQW020A0A641Z	48V (36-75Vdc)	5V	20A	Negative	Through hole	CC109139052
EQW020A0A81Z	48V (36-75Vdc)	5V	20A	Negative	Through hole	CC109151560
EQW020A0A61-CZ	48V (36-75Vdc)	5V	20A	Negative	Through hole	CC109127817
EQW020A0A641-CZ	48V (36-75Vdc)	5V	20A	Negative	Through hole	CC109149051
EQW020A0A1-HZ	48V (36-75Vdc)	5V	20A	Negative	Through hole	CC109122198
EQW020A0A4-HZ	48V (36-75Vdc)	5V	20A	Positive	Through hole	CC109140415
EQW020A0A41-HZ	48V (36-75Vdc)	5V	20A	Negative	Through hole	CC109143517
EQW020A0A41-SZ	48V (36-75Vdc)	5V	20A	Negative	Surface Mount	CC109113866
EQW020A0A41-SBZ	48V (36-75Vdc)	5V	20A	Negative	Surface Mount	CC109114096
EQW030A0F1Z	48V (36-75Vdc)	3.3V	30A	Negative	Through hole	CC109114063
EQW030A0F41Z	48V (36-75Vdc)	3.3V	30A	Negative	Through hole	CC109121225
EQW030A0F61Z	48V (36-75Vdc)	3.3V	30A	Negative	Through hole	CC109136132
EQW030A0F641Z	48V (36-75Vdc)	3.3V	30A	Negative	Through hole	CC109138921
EQW030A0F841Z	48V (36-75Vdc)	3.3V	30A	Negative	Through hole	CC109133402
EQW030A0F1-HZ	48V (36-75Vdc)	3.3V	30A	Negative	Through hole	CC109122173
EQW030A0F41-HZ	48V (36-75Vdc)	3.3V	30A	Negative	Through hole	CC109137353
EQW030A0F641-HZ	48V (36-75Vdc)	3.3V	30A	Negative	Through hole	CC109141033
EQW030A0F41-SZ	48V (36-75Vdc)	3.3V	30A	Negative	Surface Mount	CC109129158
EQW035A0GZ	48V (36-75Vdc)	2.5V	35A	Positive	Through hole	CC109162335
EQW035A0G1Z	48V (36-75Vdc)	2.5V	35A	Negative	Through hole	CC109114427
EQW035A0G641Z	48V (36-75Vdc)	2.5V	35A	Negative	Through hole	CC109138938
EQW040A0Y1Z	48V (36-75Vdc)	1.8V	40A	Negative	Through hole	CC109114451
EQW040A0Y641Z	48V (36-75Vdc)	1.8V	40A	Negative	Through hole	CC109132180
EQW040A0Y41-SZ	48V (36-75Vdc)	1.8V	40A	Negative	Surface Mount	CC109129202
EQW040A0M1Z	48V (36-75Vdc)	1.5V	40A	Negative	Through hole	CC109114435
EQW040A0M61-CZ	48V (36-75Vdc)	1.5V	40A	Negative	Through hole	CC109127593
EQW040A0P1Z	48V (36-75Vdc)	1.2V	40A	Negative	Through hole	CC109114443
EQW040A0P641Z	48V (36-75Vdc)	1.2V	40A	Negative	Through hole	CC109121258
EQW040A0P41-SZ	48V (36-75Vdc)	1.2V	40A	Negative	Surface Mount	CC109127841
EQW040A0S1R01Z	48V (36-75Vdc)	1.0V	40A	Negative	Through hole	CC109114492
EQW040A0S1R041-SZ	48V (36-75Vdc)	1.0V	40A	Negative	Surface Mount	CC109125787

-Z Indicates RoHS Compliant modules

Table 2. Device Options

Option*	Suffix**
Negative remote on/off logic	1
Auto Re-start (for Over Current / Over voltage Protection)	4
Pin Length: 3.68 mm $\pm$ 0.25mm , (0.145 in. $\pm$ 0.010 in.)	6
Pin Length: 2.79 mm $\pm$ 0.25mm , (0.110 in. $\pm$ 0.010 in.)	8
Heat plate (Module height = 12.2 mm (0.48 in.) nominal, use with cold-plates)	-C
Heat plate (Module height = 10.4 mm (0.41 in.) nominal, use with heat sinks)	-H
Surface mount connections (not available with heat plate options -C, -H)	-S
Alternative Voltage Programming equations (1.0V and 1.2V modules only)	-V

Note: Legacy device codes may contain a –B option suffix to indicate 100% factory Hi-Pot tested to the isolation voltage specified in the Absolute Maximum Ratings table. The 100% Hi-Pot test is now applied to all device codes, with or without the –B option suffix. Existing comcodes for devices with the –B suffix are still valid; however, no new comcodes for devices containing the –B suffix will be created.



**LINEAGE POWER**<sup>®</sup>

**World Wide Headquarters**

**Lineage Power Corporation**

601 Shiloh Road, Plano, TX 75074, USA

**+1-800-526-7819**

(Outside U.S.A.: **+1-972-244-9428**)

**www.lineagepower.com**

**e-mail: techsupport1@lineagepower.com**

**Asia-Pacific Headquarters**

Tel: +65 6593 7211

**Europe, Middle-East and Africa Headquarters**

Tel: +49 89 878067-280

**India Headquarters**

Tel: +91 80 28411633

Lineage Power reserves the right to make changes to the product(s) or information contained herein without notice. No liability is assumed as a result of their use or application. No rights under any patent accompany the sale of any such product(s) or information.

Lineage Power DC-DC products are protected under various patents. Information on these patents is available at [www.lineagepower.com/patents](http://www.lineagepower.com/patents).

© 2009 Lineage Power Corporation, (Plano, Texas) All International Rights Reserved.