

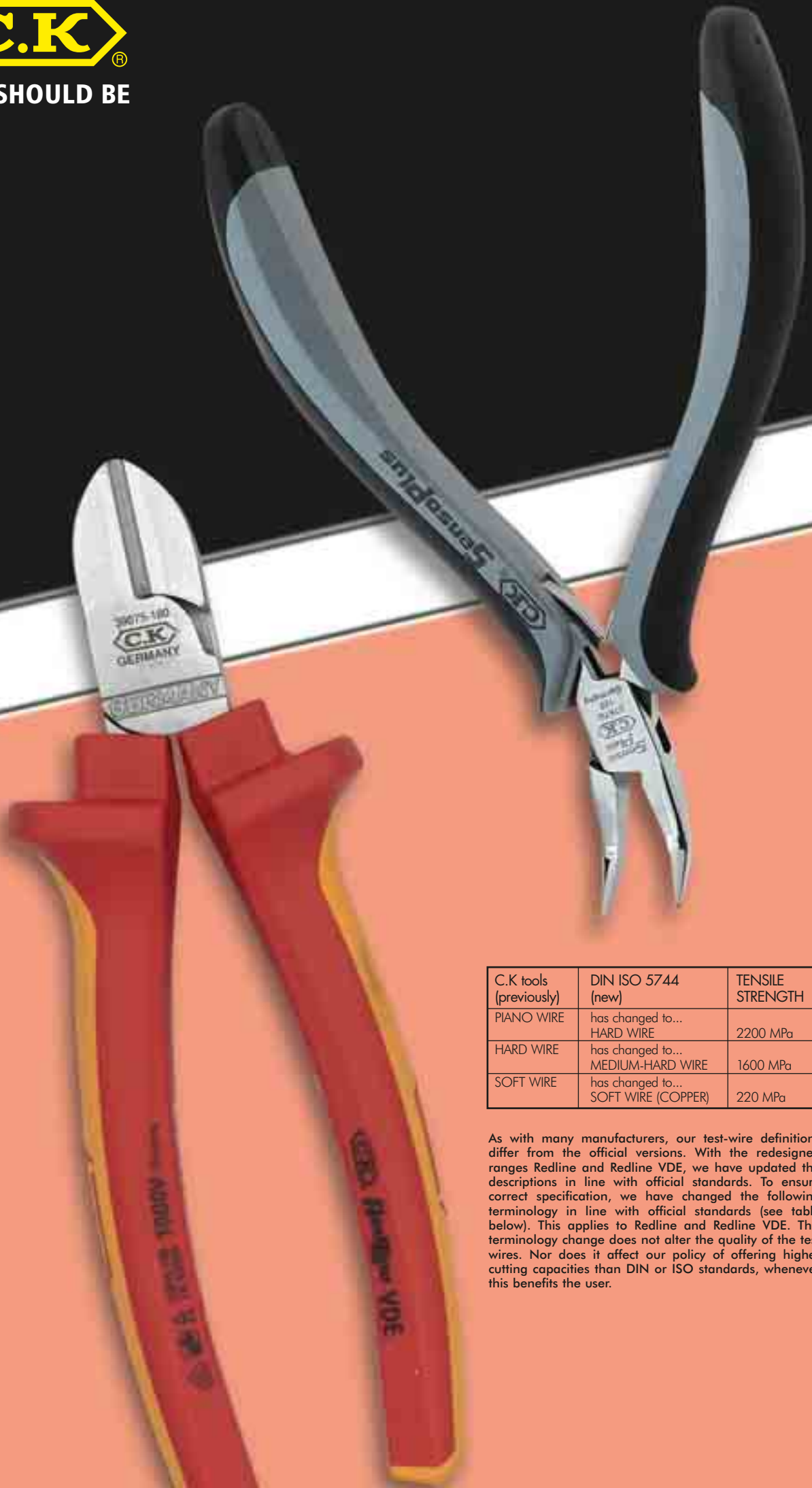

HOW TOOLS SHOULD BE



C.K tools (previously)	DIN ISO 5744 (new)	TENSILE STRENGTH
PIANO WIRE	has changed to... HARD WIRE	2200 MPa
HARD WIRE	has changed to... MEDIUM-HARD WIRE	1600 MPa
SOFT WIRE	has changed to... SOFT WIRE (COPPER)	220 MPa

As with many manufacturers, our test-wire definitions differ from the official versions. With the redesigned ranges Redline and Redline VDE, we have updated the descriptions in line with official standards. To ensure correct specification, we have changed the following terminology in line with official standards (see table below). This applies to Redline and Redline VDE. This terminology change does not alter the quality of the test wires. Nor does it affect our policy of offering higher cutting capacities than DIN or ISO standards, whenever this benefits the user.



PLIERS & CUTTERS



THE PLIERS & CUTTERS RANGE INCLUDES

RedLine
RedLine VDE
Classic
Electronic
SensoPlus Electronic
Ecotronic
Tweezers
Wrenches
Waterpump Pliers
Specialist Pliers
Fencing Pliers
Ratchet Crimping Tools
Non-Ratchet Crimping Tools
Circlip Pliers
Riveting Pliers
Specialist Cutters

GET A GRIP ON IT

We have refined our pliers through many generations, to create an unrivalled range. Every pair you can lay your hands on offers comfort and excellent performance. What's more, as the demands on the product have diversified and specialised, our range has expanded to meet the needs of each trade and individual application.

Our tools are at the cutting-edge of technology. And we keep them there with constant research and development. We are always seeking new technologies that will give our customers top-quality craftsmanship at even better value for money. Our two-component plastics technology in our new RedLine range is just one example.

EXACTING STANDARDS

We manufacture our range to the most exacting standards. Indeed, our pliers meet or exceed every standard set by DIN, ISO, VDE or EN, as applicable. We also pay extra attention to hardness, torque load and dimensions of test wires, to offer a range of tools that leads its class.



HOW TOOLS SHOULD BE

RedLine PLIERS

EXCEED ALL RELEVANT DIN AND ISO STANDARDS

providing guaranteed quality. All products have the features detailed above, specific product specifications are given in the individual listings.

Redline from C.K is the standard against which all general pliers are judged. Each plier is manufactured in Germany to the stringent DIN and ISO standards, guaranteeing quality of manufacture to certified standards.

A comprehensive range. Redline is the ideal plier for the professional or DIY user. All products are display packed on recyclable economic clip hangers, unless otherwise stated.

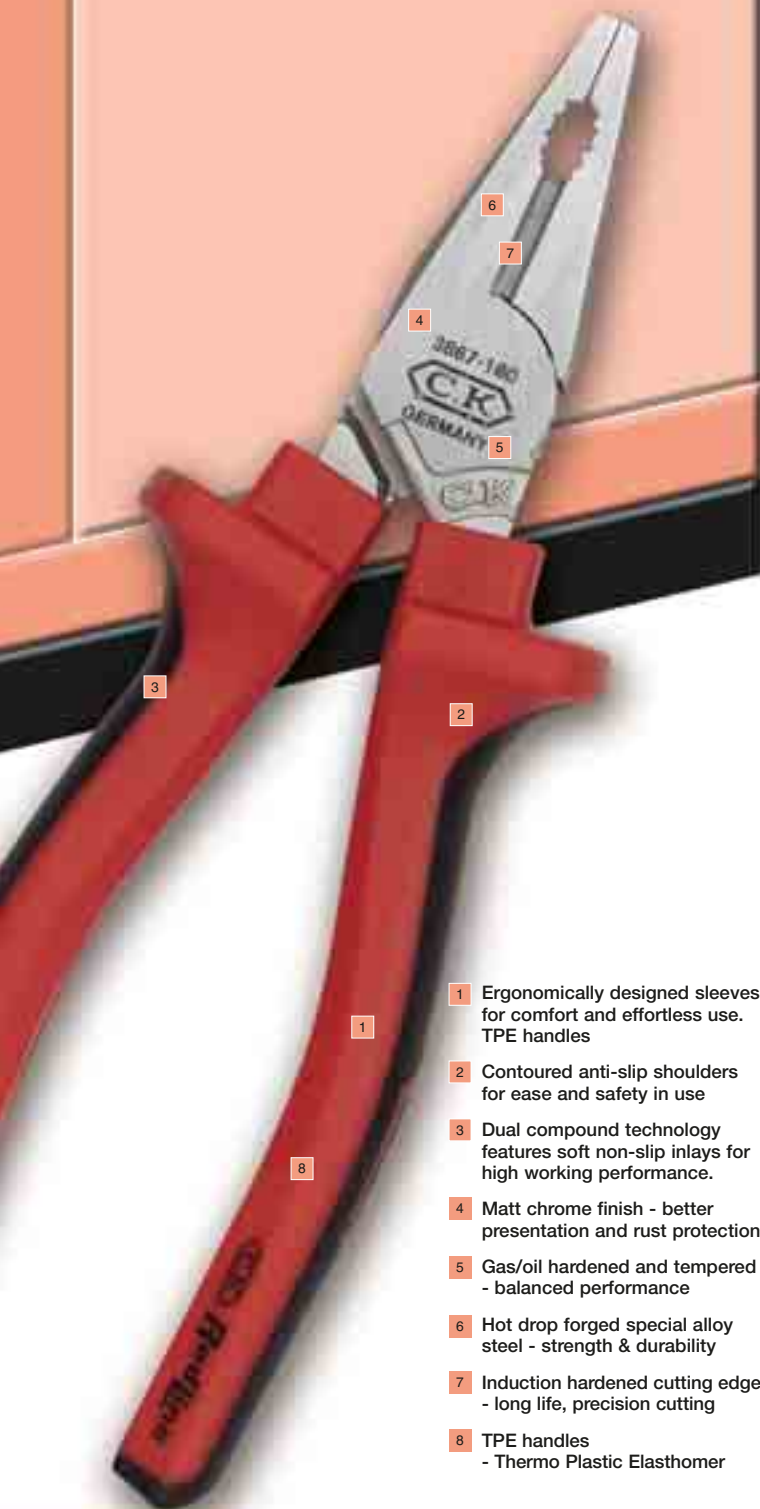

- 1 Ergonomically designed sleeves for comfort and effortless use. TPE handles
- 2 Contoured anti-slip shoulders for ease and safety in use
- 3 Dual compound technology features soft non-slip inlays for high working performance.
- 4 Matt chrome finish - better presentation and rust protection
- 5 Gas/oil hardened and tempered - balanced performance
- 6 Hot drop forged special alloy steel - strength & durability
- 7 Induction hardened cutting edges - long life, precision cutting
- 8 TPE handles - Thermo Plastic Elastomer

SIDE CUTTERS 3751

Swedish pattern side cutter for use on wire with hardness from soft up to hard.

ISO 5749, DIN 5238B.



SIZE	CUTTING CAPACITY: mm Ø WIRE			ITEM NO	BOX QTY	WEIGHT
	HARD	MED/HARD	SOFT			
130mm/5"	1.2	1.6	>4.0	T3751 5	3	140g
145mm/5½"	1.4	1.9	>4.0	T3751 55	3	185g
160mm/6"	1.6	2.1	>4.0	T3751 6	3	220g
180mm/7"	1.8	2.3	>4.0	T3751 7	3	280g

'ELECTRO' SIDE CUTTERS 3750

Cutting edges specifically engineered to cut cleanly through cable but also strong enough for med/hard wire. Head and jaw configuration gives high leverage and ease of use.

ISO 5749, DIN 5238B.



SIZE	CUTTING CAPACITY: mm Ø WIRE		ITEM NO	BOX QTY	WEIGHT
	HARD	SOFT			
145mm/5½"	1.8	>4.0	T3750 145	3	170g
160mm/6"	2.0	>4.0	T3750 160	3	215g
180mm/7"	2.0	>4.0	T3750 180	3	289g

SIDE CUTTER & STRIPPER 3746

As T3750 but with 2 stripping holes for wires 1.5mm² and 2.5mm².



SIZE	CUTTING CAPACITY		ITEM NO	BOX QTY	WEIGHT
	HARD	SOFT			
160mm/6"	2.0	>4.0	T3746	3	215g

HEAVY DUTY SIDE CUTTERS 3720

Cutting edges induction hardened to 60-61 HRC. Heavy duty design gives extra leverage for strength and smooth cutting.

ISO 5749, DIN 5238A.



SIZE	CUTTING CAPACITY: mm Ø WIRE			ITEM NO	BOX QTY	WEIGHT
	HARD	MED/HARD	SOFT			
145mm/5½"	1.5	2.0	>4.0	T3720 55	3	190g
165mm/6½"	2.0	2.5	>4.0	T3720 65	3	260g
200mm/8"	2.5	3.0	>4.0	T3720 8	3	315g

SNIPE NOSE PLIERS 3909

Cut inside jaws, rod gripping hole and cutting edges.

ISO 5745, DIN 5236A.



SIZE	CUTTING CAPACITY: mm Ø WIRE		ITEM NO	BOX QTY	WEIGHT
	HARD	SOFT			
145mm/5½"	1.6	>4.0	T3909 5	3	210g
170mm/6¾"	1.6	>4.0	T3909 6	3	165g

COMBINATION PLIERS 3867

Extra long cutting edges induction hardened for use on med/hard wire, round and flat cable.

ISO 5746, DIN 5244.



SIZE	CUTTING CAPACITY: mm Ø WIRE			ITEM NO	BOX QTY	WEIGHT
	HARD	MED/HARD	SOFT			
160mm/6"	1.6		>4.0	T3867 6	3	215g
180mm/7"	1.6		>4.0	T3867 7	3	280g
200mm/8"	2.0		>4.0	T3867 8	3	340g

FLAT NOSE PLIERS 3807

Cut inside jaws for extra grip and ease of handling.

ISO 5745, DIN 5248.



SIZE	ITEM NO	BOX QTY	WEIGHT
160mm/6"	T3807	3	187g

HEAVY DUTY TOP CUTTERS 3806

Heavy duty design gives high leverage which cuts even hard wire with ease. Induction hardened cutting edges to 60-61 HRC.

ISO 5748, DIN 5252A.



SIZE	CUTTING CAPACITY: mm Ø WIRE			ITEM NO	BOX QTY	WEIGHT
	HARD	MED/HARD	SOFT			
160mm/6"	1.5	2.0	>4.0	T3806	3	255g

SNIPE NOSE PLIERS 3906

Long head snipe nose pliers. Cut inside jaws, rod gripping hole and cutting edges.

ISO 5745, DIN 5236A.





SIZE	CUTTING CAPACITY: mm Ø WIRE	ITEM NO	BOX QTY	WEIGHT
	HARD SOFT			
200mm/8"	1.6 >4.0	T3906 8	3	210g

FOR DISPLAY INFORMATION SEE PAGES 214-219

BENT SNIPE NOSE PLIERS					3907	
45° bent long snipe nose pliers with rod gripping hole, cut inside jaws and cutting edge.						
ISO 5745, DIN 5236B.						
						
SIZE	CUTTING CAPACITY: mm Ø WIRE			ITEM NO	BOX QTY	WEIGHT
200mm/8"	HARD	MED/HARD	SOFT	T3907 8	3	210g

CABLE CUTTERS					3964	
Compact, one handed cable cutter, suitable for copper or aluminium wire up to 14mm / 9/16" Ø. Knife edge splits insulation sheathing, razor sharp blade grip while it cuts with no cable squeeze. Manufactured from hot drop forged special alloy steel for strength and durability, matt chrome plated.						
						
SIZE	CAPACITY			ITEM NO	BOX QTY	WEIGHT
165mm/6½"	14mm/9/16"			T3964 6	3	270g

WIRE STRIPPING PLIERS					3754	
Ideal product for repetitive work with soft TPE handles and coil spring. Adjustable capacity using the brass setting screw and lock nut. Wire capacity of 0.3-5.0mm diameter.						
DIN 5232.						
						
SIZE	ITEM NO			BOX QTY	WEIGHT	
160mm/6"	T3754			3	188g	

WATERPUMP PLIERS					3654	
Laid on joint construction with 5 position adjustment. Double groove joint for extra safety.						
DIN 5231F.						
						
SIZE	CAPACITY			ITEM NO	BOX QTY	WEIGHT
250mm/10"	32mm/1¼"			T3654	3	430g

SET				3803	
Plastic Display wallet containing: 3 Redline pliers - 3867 180mm Combination Pliers, 3750 160mm Side Cutters, 3906 200mm Snipe Nose Pliers.					
					
DIMENSIONS			ITEM NO	WEIGHT	
335 x 150 x 30mm			T3803	700g	

DISPLAY RACK					2128	
Suitable for your choice of six patterns.						
						
SIZE	DESCRIPTION			ITEM NO	WEIGHT	
410x110mm	Empty rack with sticker - Redline Hooks (x6)			T2128	700g	
				T2103		

FOR DISPLAY INFORMATION SEE PAGES 214 -219

RedLine VDE

AN ELECTRICIAN'S RANGE WITH ADDED VALUE

The VDE Standards - Verband Deutscher Elektrotechniker - are designed to protect all personnel working on and around live equipment up to 1000V. Redline® VDE meets all the criteria for VDE 0682-201 & EN60900 making it one of the safest plier ranges available today. This range has taken advantage of the very latest two component technology to ensure top quality at a very competitive price. Display packed.



AC1000V
EN60900

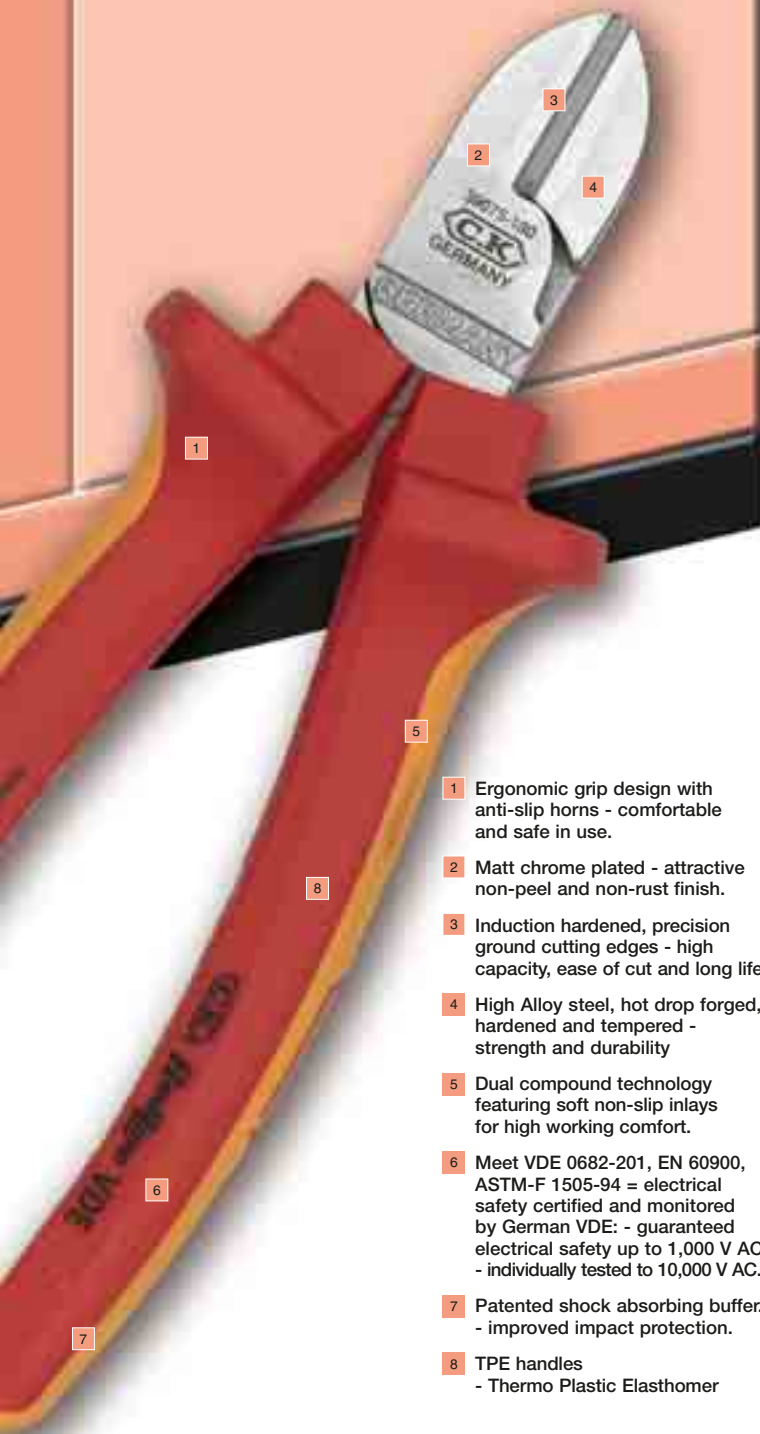

- 1 Ergonomic grip design with anti-slip horns - comfortable and safe in use.
- 2 Matt chrome plated - attractive non-peel and non-rust finish.
- 3 Induction hardened, precision ground cutting edges - high capacity, ease of cut and long life
- 4 High Alloy steel, hot drop forged, hardened and tempered - strength and durability
- 5 Dual compound technology featuring soft non-slip inlays for high working comfort.
- 6 Meet VDE 0682-201, EN 60900, ASTM-F 1505-94 = electrical safety certified and monitored by German VDE: - guaranteed electrical safety up to 1,000 V AC - individually tested to 10,000 V AC.
- 7 Patented shock absorbing buffer. - improved impact protection.
- 8 TPE handles - Thermo Plastic Elastomer

VDE WIRE STRIPPING PLIERS 39074

Coil spring. Brass adjustment screw and lock nut.

VDE 0682/201, EN 60900, DIN 5232 ASTM-F 1505-94

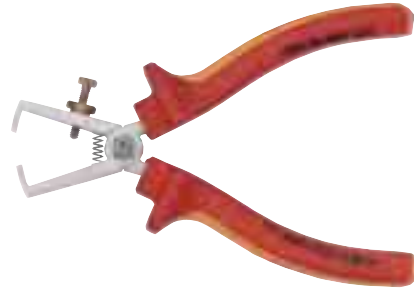

SIZE	STRIPPING CAPACITY: mm Ø	ITEM NO	BOX QTY	WEIGHT
160mm/6"	0.3 - 5.0	T39074	3	220g

VDE COMBINATION PLIERS 39072

VDE 0682/201, EN 60900, ISO 5746, DIN 5244 ASTM-F 1505-94



SIZE	CUTTING CAPACITY: mm Ø WIRE			ITEM NO	BOX QTY	WEIGHT
	MED/HARD	SOFT	>4.0			
180mm/7"	1.6	>4.0	T39072 7	3	280g	
200mm/8"	2.0	>4.0	T39072 8	3	340g	

VDE SIDE CUTTERS 39075

Revolutionary head design gives high leverage and easy, clean cutting.

VDE 0682/201, EN 60900, ISO 5749, DIN 5238B ASTM-F 1505-94



SIZE	CUTTING CAPACITY: mm Ø WIRE			ITEM NO	BOX QTY	WEIGHT
	HARD	MED/HARD	SOFT			
160mm/6"	1.6	2.1	>4.0	T39075 6	3	220g
180mm/7"	1.8	2.3	>4.0	T39075 7	3	280g

VDE SNIPE NOSE PLIERS 39070

Bent.

VDE 0682/201, EN 60900, ISO 5745, DIN 5236B ASTM-F 1505-94



SIZE	CUTTING CAPACITY: mm Ø WIRE			ITEM NO	BOX QTY	WEIGHT
	MED/HARD	SOFT	>4.0			
200mm/8"	1.6	>4.0	T39070	3	210g	

WARNING Do not use on live circuits. For use around live circuits not exceeding 1000V AC. Do not touch non insulated areas when in use. Do not use if insulation appears damaged in any way eg: voids, cracks or breaks. Visually inspect before every use. Keep clean and dry for continuing insulation properties and longer life.

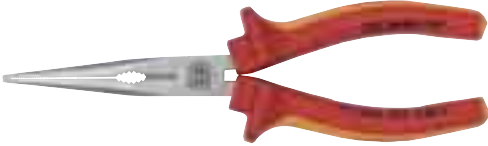
VDE SNIPE NOSE PLIERS				39076	
Straight					
VDE 0682/201, EN 60900, ISO 5749, DIN 5238B ASTM-F 1505-94					
					
SIZE	CUTTING CAPACITY: mm Ø WIRE		ITEM NO	BOX QTY	WEIGHT
	MED/HARD	SOFT			
170mm/6 7/8"	1.6	>4.0	T39076 675	3	165g
200mm/8"	1.6	>4.0	T39076 8	3	210g

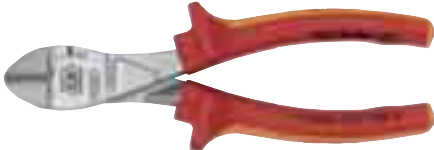
VDE HEAVY DUTY SIDE CUTTERS				39073		
Heavy duty design and extra leverage for best cutting performance and high capacity.						
VDE 0682/201, EN 60900, ISO 5749, DIN 5238B ASTM-F 1505-94						
						
SIZE	CUTTING CAPACITY: mm Ø WIRE		ITEM NO	BOX QTY	WEIGHT	
	HARD	MED/HARD	SOFT			
165mm/6 1/2"	2.0	2.5	>4.0	T39073 650	3	260g
200mm/8"	2.5	3.0	>4.0	T39073 8	3	315g

VDE HEAVY DUTY CABLE CUTTERS				39064	
Compact, one handed cable cutting with a large capacity of up to 25mm. 165mm size has a single blade action, the 210mm has a revolutionary two step cutting edge, one with extra leverage the other with anti-slip serration. Cuts cleanly, and effortlessly.					
VDE 0682/201, EN 60900 ASTM-F 1505-94					
					
SIZE	STRIPPING CAPACITY: mm Ø		ITEM NO	BOX QTY	WEIGHT
165mm/6"	14mm		T39064	3	270g
210mm/8 1/4"	25mm		T39064 8	3	315g

DISPLAY RACK				2130	
Suitable for your choice of six patterns.					
					
SIZE	DESCRIPTION	ITEM NO			WEIGHT
410x110mm	Empty rack with sticker - Redline VDE Hooks (x6)	T2130 T2103			700g

VDE TOOL SET 15PC - PZD				17051LS	
Robust tool wallet, made from artificial leather. Plastic handles. Closing catch.					
CONTAINING ONE EACH OF:					
Side Cutter 39075	180mm/7"	Combination Pliers 39072	180mm/7"		
Snipe Nose Pliers 39076	170mm/6 3/4"	Waterpump Pliers 3979	240mm/9 1/2"		
Wire Stripping Pliers 39074	160mm/6"				
Screwdrivers 4735	75 x 2.8, 100 x 4, 125 x 4.5, 150 x 6.5				
Screwdrivers 4733	PZD/PZD 2				
VDE 0682/201, EN 60900 IEC 60900 ASTM-F 1505-94					
					
DIMENSIONS	DESCRIPTION	ITEM NO	BOX QTY	WEIGHT	
360 x 330 x 80mm	Bag with stock	T17051LS	1	2.3kg	

VDE TOOL SET 9PC - PZD				36070S	
Ideal electricians set of the popular SensoPlus pliers and screwdrivers held within a vinyl zipper case.					
CONTAINING ONE EACH OF:					
Wire stripping pliers 39074	160mm/6"	Screwdrivers 49044	75x2.5, 100x3, 125x5.5		
Side cutters 39075	160mm/6"	Screwdrivers 49043	PZD1, PZD2		
Snipe nose pliers 39076	170mm/6 3/4"	Mainstester 4952			
VDE 0682/201, EN 60900 IEC 60900 ASTM-F 1505-94					
					
WALLET SIZE	DESCRIPTION	ITEM NO	BOX QTY	WEIGHT	
245 x 270 x 50mm	Set with stock	T36070S	1	1.306kg	

VDE TOOL SET 9PC - PH				36070	
As 36070S, but replacing PZD with Phillips Screwdriver 49042 1 & 2.					
VDE 0682/201, EN 60900 IEC 60900 ASTM-F 1505-94					
	DESCRIPTION	ITEM NO	BOX QTY	WEIGHT	
	Set with stock	T36070	1	1.306kg	

FOR DISPLAY INFORMATION SEE PAGES 214 -219

CLASSIC PLIERS

CLASSIC RANGE OF PLIERS FOR THE PROFESSIONAL AND AMATEUR ALIKE

This full range of pliers has been developed and manufactured to appeal to individuals who take pride in their work. The Classic Range is for everyday use in the home or workshop.

All products have been designed and developed by the C.K. team to meet the most stringent quality standards.

Display packed on recyclable clip hangers. Compact but complete range for the occasional or hobby user. Manufactured to C.K.'s stringent quality standards, quality guaranteed. Economy of price not value, excellent value for money. Display packed.

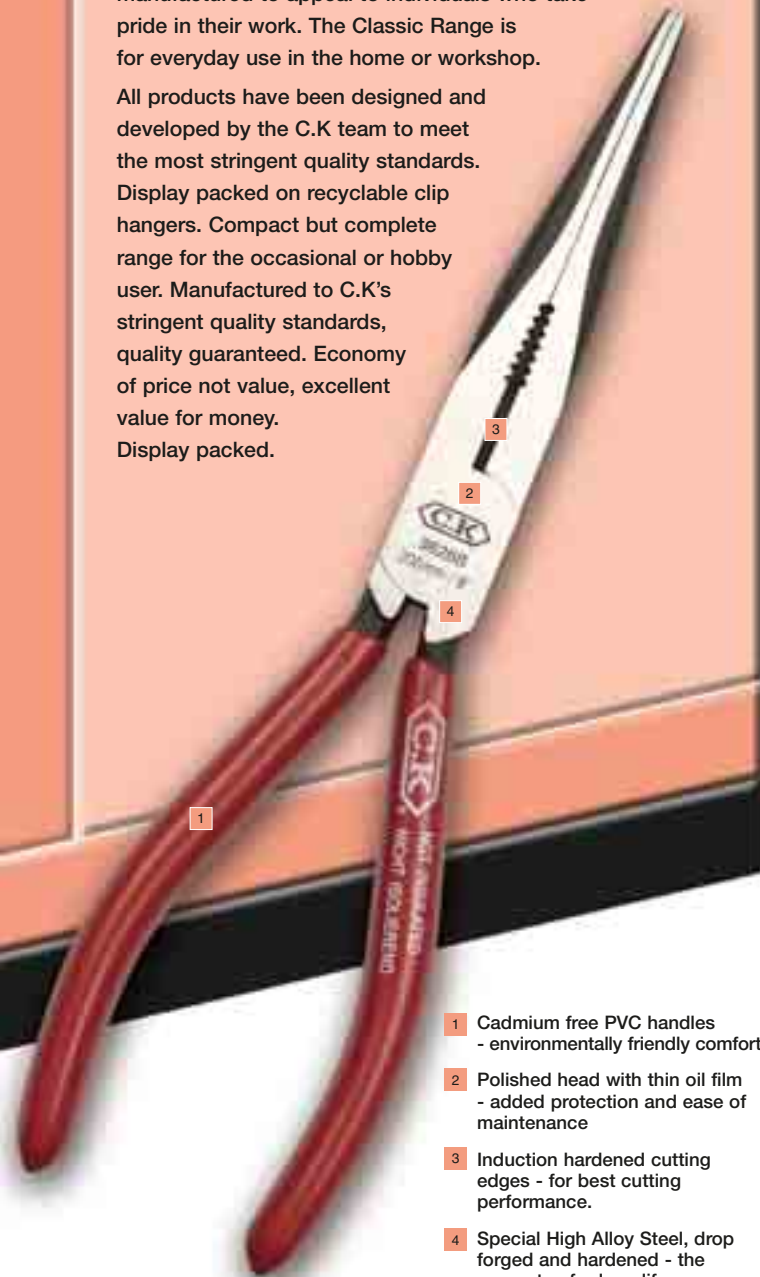

- 1 Cadmium free PVC handles - environmentally friendly comfort.
- 2 Polished head with thin oil film - added protection and ease of maintenance
- 3 Induction hardened cutting edges - for best cutting performance.
- 4 Special High Alloy Steel, drop forged and hardened - the guarantee for long life.

COMBINATION PLIERS 3621

These combination pliers have extra long cutting edges for round and flat cables, and rod gripping hole.

ISO 5746, DIN 5244



SIZE	CUTTING CAPACITY: mm Ø WIRE		ITEM NO	BOX QTY	WEIGHT
	HARD	SOFT			
160mm/6"	1.6	>4.0	T3621B 6	3	181g
180mm/7"	1.6	>4.0	T3621B 7	3	261g
200mm/8"	1.6	>4.0	T3621B 8	3	307g

SNIPE NOSE PLIERS 3622

Short head with cutting edge and cut inside jaws.

ISO 5745, DIN 5236A



SIZE	CUTTING CAPACITY: mm Ø WIRE			ITEM NO	BOX QTY	WEIGHT
	HARD	MED/HARD	SOFT			
140mm/5 1/4"	1.6	2.5	>4.0	T3622B	3	115g

SIDE CUTTERS 3623

Suitable for soft and medium/hard wire.

ISO 5749/4, DIN 5238B



SIZE	CUTTING CAPACITY: mm Ø WIRE			ITEM NO	BOX QTY	WEIGHT
	MED/HARD	SOFT				
145mm/5"	1.6	>3.0		T3623B 5	3	162g
160mm/6"	1.6	>3.0		T3623B 6	3	203g

SNIPE NOSE PLIERS 3626

Long head with cutting edge and cut inside jaws.

ISO 5745, DIN 5236A



SIZE	CUTTING CAPACITY: mm Ø WIRE			ITEM NO	BOX QTY	WEIGHT
	HARD	MED/HARD	SOFT			
170mm/6 1/4"	1.6	2.5	>4.0	T3626B 6	3	130g
200mm/8"	1.6	2.5	>4.0	T3626B 8	3	179g

SIDE CUTTERS HEAVY DUTY 3627

High leverage, heavy duty cutters for soft and medium/hard wire. High capacity with smooth, easy cutting action.

ISO 5749/3, DIN 5238A



SIZE	CUTTING CAPACITY: mm Ø WIRE			ITEM NO	BOX QTY	WEIGHT
	MED/HARD	SOFT				
180mm/7"	1.8	>4.0		T3627B 7	3	233g

WIRE STRIPPING PLIERS 3752

Excellent for repetitive work with coil spring, accurately ground joints and cutting edges (for use on insulation only). Adjustable brass locking nut and screw.

DIN 5232

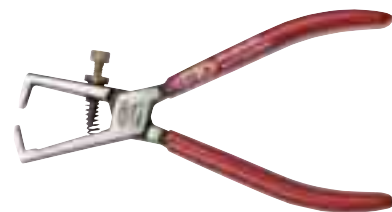

SIZE	STRIPPING CAPACITY: mm Ø	ITEM NO	BOX QTY	WEIGHT
160mm/6"	0.3 - 5.0			

ELECTRONIC AND *SensoPlus*® ELECTRONIC PLIERS

The Electronics Industry demands the highest quality and precision from all its components and tools.

The C.K Electronic Range of pliers and cutters conforms perfectly to market requirements. C.K attention to detail and quality specification has produced the ultimate range for use in the electronics and precision engineering industries. Each plier is individually tested by a skilled craftsman to ensure accuracy of movement and cut.





The *SensoPlus*® range

This uses the same base product but has a new improved handle design, tailored to your hand's shape and feel. This perfect shape is designed with your hand in mind. It has a grip which feels like a fine kid glove, fatigue free with safe control for the most-exacting work demands.



The C.K Electronics catalogue contains the complete range of pliers, screwdrivers, tweezers and other products specially designed and manufactured for this sector.

KEY REFERENCE:

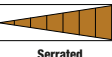
	Designed for the cutting of hard and soft steel wires as well as softer materials like copper wire and cable.		For absolutely flat cuts of softer steel, copper wires and cables. Extremely fine.
	Almost full flush cutting, with fine cutting edges. Side cutters for softer steel as well as copper wires and cables.		

 For use in ESD compatible areas. **S** Indicates a SensoPlus product.

ITEM NO: "D" refers to a SensoPlus handle.

LIFETIME GUARANTEE



- 1 PVC coated handles - comfort and non slip use
- 2 High grade alloy steel, Hot drop forged, Oil hardened and tempered
- 3 long life and perfect precision
- 4 Soft, comfortable and slip free thermoplastic material compound grips.
- 5 Spot-welded double leaf spring ensures consistently repeatable functioning for a lifetime of top performance.
- 6 Anti-slip bow enhances pin-point control.
- 7 Precision box joint means butter smooth action for exact guidance of jaws without the need for readjustment.
- 8 Mirror polishing notable reduces risks of corrosion, chrome flaking, and is easy to clean.
- 9 Long-life cutting edges are induction hardened to maintain cutting ease.
- 10 The SensoPlus range is ESD compatible

3772
Serrated and smooth jaws.

3772

3772D

DESCRIPTION	ITEM NO	BOX QTY	WEIGHT
130mm/5¼" Smooth	T3772	3	49g
130mm/5¼" Serrated	T3772 1	3	49g
135mm/5¼" Smooth	T3772D 120	3	59g
135mm/5¼" Serrated	T3772 1D120	3	59g

3767
Bent. Short fine jaws.

3767

3767D

DESCRIPTION	ITEM NO	BOX QTY	WEIGHT
120mm/4¾" Smooth Jaws	T3767	3	46g
135mm/5¼" Smooth Jaws	T3767D 120	3	56g

3777
Long head snipe nose pliers with serrated inside jaws.

3777

3777D

DESCRIPTION	ITEM NO	BOX QTY	WEIGHT
150mm/6" Serrated	T3777	3	84g
165mm/6½" Serrated	T3777D 150	3	94g

3769
Bent, long jaws, serrated.

3769

3769D

DESCRIPTION	ITEM NO	BOX QTY	WEIGHT
150mm/6" Serrated	T3769	3	86g
165mm/6½" Serrated	T3769D 150	3	96g

3795
Straight, with smooth jaws, without springs.

3795

DESCRIPTION	ITEM NO	BOX QTY	WEIGHT
190mm/7½" Smooth Jaws.	T3795	3	131g

SensoPlus®
U.S. Patent No. Des 406,520. ©BRD No. 397 08 814
©EU No. 000 527 127. ©USA No. 2,235,654. ©Taiwan No. 00797439
SensoPlus: Plastic grips and sleeves are not intended to provide protection against electric shock.

FOR DISPLAY INFORMATION SEE PAGES 214-219

ROUND NOSE PLIERS 3771

Smooth inside jaws.

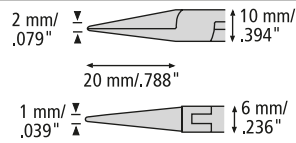

3771



3771D



	DESCRIPTION	ITEM NO		BOX QTY	WEIGHT
	120mm/4 3/4"	Smooth	T3771	3	67g
	135mm/5 1/4"	Smooth	T3771D 120	3	77g

FLAT NOSE PLIERS 3770

Short smooth jaws.

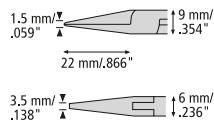

3770D



	DESCRIPTION	ITEM NO		BOX QTY	WEIGHT
	135mm/5 1/4"	Smooth	T3770D 120	3	73g

FLAT NOSE PLIERS 3789

Smooth jaws.

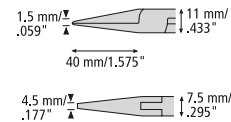

3789



	DESCRIPTION	ITEM NO		BOX QTY	WEIGHT
	145mm/5 3/4"	Smooth Jaws.	T3789	3	78g

SIDE CUTTER 3740

Half oval head. For confined spaces. High cutting capacity. Mini bevel cut.

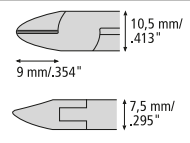

3740D



	CUTTING CAPACITY: mm Ø AWG			ITEM NO		BOX QTY	WEIGHT
	HARD WIRE	SOFT STEEL	COPPER				
	125mm/5"	0.4/26	1.0/18	1.5/15	T3740D 115	3	63g

SIDE CUTTER 3766

Tapered and relieved head. Also for SMD-use. Full & extra full cut options.

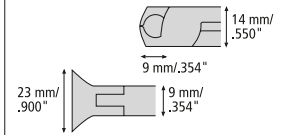

3766D



	CUTTING CAPACITY: mm Ø AWG			ITEM NO		BOX QTY	WEIGHT
	HARD WIRE	SOFT STEEL	COPPER				
	120mm/4 3/4"	-	0.6/22	1.0/18	T3766DF 110	3	48g
	120mm/4 3/4"	-	0.6/22	1.0/18	T3766DEF 110	3	58g

SIDE CUTTERS 3768

Tapered head, heavy pattern, high cutting capacity and mini bevel cut.

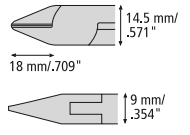

3768



	CUTTING CAPACITY: mm Ø AWG			ITEM NO		BOX QTY	WEIGHT
	HARD WIRE	SOFT STEEL	COPPER				
	135mm/5 1/4"	0.5/24	1.2/16	1.8/13	T3768	3	100g

KEY REFERENCE:

	Designed for the cutting of hard and soft steel wires as well as softer materials like copper wire and cable.		For absolutely flat cuts of softer steel, copper wires and cables. Extremely fine.
	Almost full flush cutting, with fine cutting edges. Side cutters for softer steel as well as copper wires and cables.		

For use in ESD compatible areas. **S** Indicates a SensoPlus product.

ITEM NO: "D" refers to a SensoPlus handle.

FOR DISPLAY INFORMATION SEE PAGES 214 -219

SIDE CUTTERS 3773

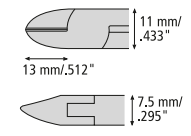

Oval head for use in confined areas. Three cut options.

3773



3773D

CUTTING CAPACITY: mm Ø AWG	CUTTING CAPACITY: mm Ø AWG			ITEM NO	BOX QTY	WEIGHT
	HARD WIRE	SOFT STEEL	COPPER			
115mm/4½"	0.4/26	1.0/18	1.5/15	T3773	3	65g
115mm/4½"	-	1.0/18	1.5/15	T3773F	3	65g
115mm/4½"	-	1.0/18	1.5/15	T3773EF	3	65g
125mm/5"	0.4/26	1.0/18	1.5/15	T3773D 115	3	75g
125mm/5"	-	1.0/18	1.5/15	T3773DF 115	3	75g
125mm/5"	-	1.0/18	1.5/15	T3773DEF 115	3	75g

SIDE CUTTER - TUNGSTEN CARBIDE 3779

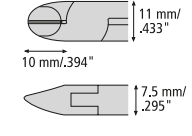

Oval head. Tungsten Carbide edges. For very hard and tough materials. Mini bevel cut.

3779



3779D

CUTTING CAPACITY: mm Ø AWG	CUTTING CAPACITY: mm Ø AWG			ITEM NO	BOX QTY	WEIGHT
	PIANO WIRE	HARD STEEL	NICKEL			
115mm/4½"	0.6/22	1.0/18	1.2/16	T3779	3	65g
125mm/5"	0.6/22	1.0/18	1.2/16	T3779D 115	3	75g

SIDE CUTTERS 3774

Laid on joint construction. Oval head with mini bevel cut.

3774

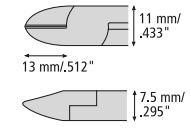

3774D

CUTTING CAPACITY: mm Ø AWG	CUTTING CAPACITY: mm Ø AWG			ITEM NO	BOX QTY	WEIGHT
	HARD WIRE	SOFT STEEL	COPPER			
120mm/4¾"	0.4/26	1.0/18	1.5/15	T3774	3	67g

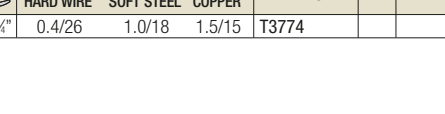
SIDE CUTTERS 3780

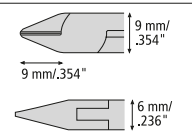

Small tapered head. Full flush cut.

3780



3780D

CUTTING CAPACITY: mm Ø AWG	CUTTING CAPACITY: mm Ø AWG			ITEM NO	BOX QTY	WEIGHT
	HARD WIRE	SOFT STEEL	COPPER			
110mm/4½"	-	0.6/22	1.0/18	T3780F	3	47g
120mm/4¾"	-	0.6/22	1.0/18	T3780DF 110	3	57g

HEAVY DUTY SIDE CUTTERS 3775

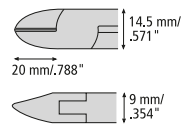

Heavy duty oval head side cutters with mini bevel cut, or extra full flush cut.

3775



3775D





CUTTING CAPACITY: mm Ø AWG	CUTTING CAPACITY: mm Ø AWG			ITEM NO	BOX QTY	WEIGHT
	HARD WIRE	SOFT STEEL	COPPER			
135mm/5¼"	0.7/21	1.5/15	2.0/12	T3775	3	100g
135mm/5¼"	-	1.5/15	2.0/12	T3775EF	3	101g

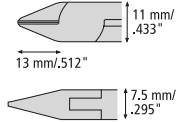

SIDE CUTTERS 3781

Tapered head, 3 cut options.



3781



3781D



CUTTING CAPACITY: mm Ø AWG	CUTTING CAPACITY: mm Ø AWG			ITEM NO	BOX QTY	WEIGHT
	HARD WIRE	SOFT STEEL	COPPER			
115mm/4½"	0.4/26	1.0/18	1.2/16	T3781	3	48g
125mm/5"	0.4/26	1.0/18	1.2/16	T3781D 115	3	58g
125mm/5"	-	1.0/18	1.2/16	T3781DF 115	3	58g
125mm/5"	-	1.0/18	1.2/16	T3781DEF 115	3	58g

SIDE CUTTER 3880

Oval head. Full flush cut.

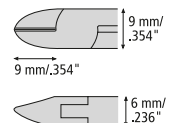

3880



3880DF



CUTTING CAPACITY: mm Ø AWG	CUTTING CAPACITY: mm Ø AWG			ITEM NO	BOX QTY	WEIGHT
	HARD WIRE	SOFT STEEL	COPPER			
110mm/4¼"	-	0.6/22	1.2/16	T3880F	3	60g
120mm/4¾"	-	0.6/22	1.2/16	T3880DF 110	3	70g

TOP CUTTERS 3776

Wide head with extra long cutting edges giving a full flush cut.

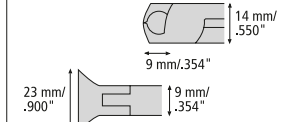

3776



CUTTING CAPACITY: mm Ø AWG	CUTTING CAPACITY: mm Ø AWG			ITEM NO	BOX QTY	WEIGHT
	HARD WIRE	SOFT STEEL	COPPER			
115mm/4½"	0.5/24	1.2/16	1.6/14	T3776F	3	72g

OBLIQUE CUTTERS 3778

Wide head, extra long cutting edges with full flush cut.

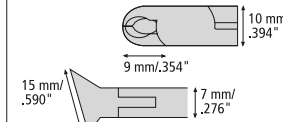

3778



CUTTING CAPACITY: mm Ø AWG	CUTTING CAPACITY: mm Ø AWG			ITEM NO	BOX QTY	WEIGHT
	HARD WIRE	SOFT STEEL	COPPER			
120mm/4¾"	0.5/24	1.2/16	1.6/14	T3778F	3	75g

OBLIQUE CUTTER 3786

Slim head. For confined spaces. Full flush cut.

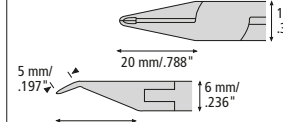

3786D



CUTTING CAPACITY: mm Ø AWG	CUTTING CAPACITY: mm Ø AWG			ITEM NO	BOX QTY	WEIGHT
	HARD WIRE	SOFT STEEL	COPPER			
135mm/5¼"	-	0.6/22	0.8/20	T3786DF 120	3	47g

CONTACT NOS:
 IRELAND Tel: +353 (0) 1•8851669
 Fax: +353 (0) 1•8851670 dublin-sales@ck-tools.com
 FRANCE No. azur +33 (0) 810•000044 Fax: +33 (0) 810•000357
 USA Tel: +1 866 484 5943 Fax: +1 630 953 2686 CKUSANICK@aol.com
 GERMANY Tel: +49 (0) 202•89030 Fax: +49 (0) 202•80715 info@ck-tools.de

OUR CUSTOMERS ARE CURRENTLY ENJOYING:

- 98% stock availability
- 2-3 day delivery
- Quality products at affordable prices

OBLIQUE CUTTERS 3799

Oblique head angled at 29° for horizontal or vertical use on PCB's. Full flush & extra full flush cut.

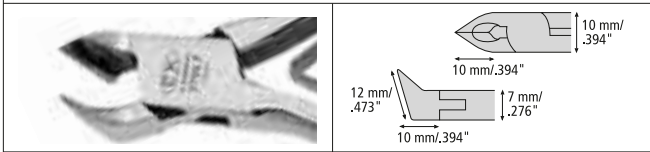

3799



3799D



CUTTING CAPACITY: mm Ø AWG	CUTTING CAPACITY: mm Ø AWG			ITEM NO	BOX QTY	WEIGHT
	HARD WIRE	SOFT STEEL	COPPER			
110mm/4¼"	0.4/26	1.0/18	1.2/16	T3799F	3	47g
120mm/4¾"	0.4/26	1.0/18	1.2/16	T3799DF 110	3	57g
120mm/4¾"	-	1.0/18	1.2/16	T3799DEF 110	3	57g

OBLIQUE CUTTER 3871

Extra long, slim jaws, for very confined spaces. Also for SMD-use. Full flush cut.

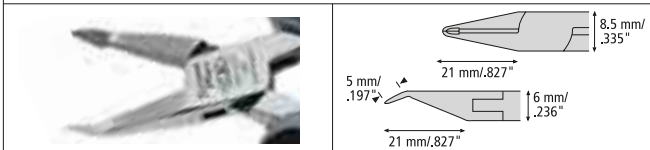

3871D



CUTTING CAPACITY: mm Ø AWG	CUTTING CAPACITY: mm Ø AWG			ITEM NO	BOX QTY	WEIGHT
	HARD WIRE	SOFT STEEL	COPPER			
135mm/5¼"	-	-	0.6/22	T3871DF 120	3	48g

KEY REFERENCE:

	Designed for the cutting of hard and soft steel wires as well as softer materials like copper wire and cable.		For absolutely flat cuts of softer steel, copper wires and cables. Extremely fine.
	Almost full flush cutting, with fine cutting edges. Side cutters for softer steel as well as copper wires and cables.		

For use in ESD compatible areas. **S** Indicates a SensoPlus product.

ITEM NO: "D" refers to a SensoPlus handle.

6 PIECE PLIERS SET IN ZIP WALLET 3703

Zipped service wallet. imitation leather. 6 compartments for pliers with maximum length 125mm.

CONTAINING:

Snipe Nose Pliers	T3772D 120
Flat Nose Pliers	T3770D 120
Side Cutters	T3773D 115
Side Cutters	T3880DF 110
Side Cutters	T3766DF 120
Oblique Cutters	T3786DF 120

3703D



SIZE OF WALLET	ITEM NO	BOX QTY	WEIGHT
180x145x45mm	T3703D	3	574g



FOR DISPLAY INFORMATION SEE PAGES 214-219

ECOTRONIC PLIERS

ECOTRONIC PLIERS AND CUTTERS - EVERYDAY ELECTRONIC RANGE

Ecotronic serves the market demand for a range of tools for occasional electronic use, where cost is more important than extra features. Ecotronic conform with C.K's requirements for top quality, being manufactured in Germany to guaranteed standards, but still offering excellent value for money. All products within this range encompass these features. Display packed.

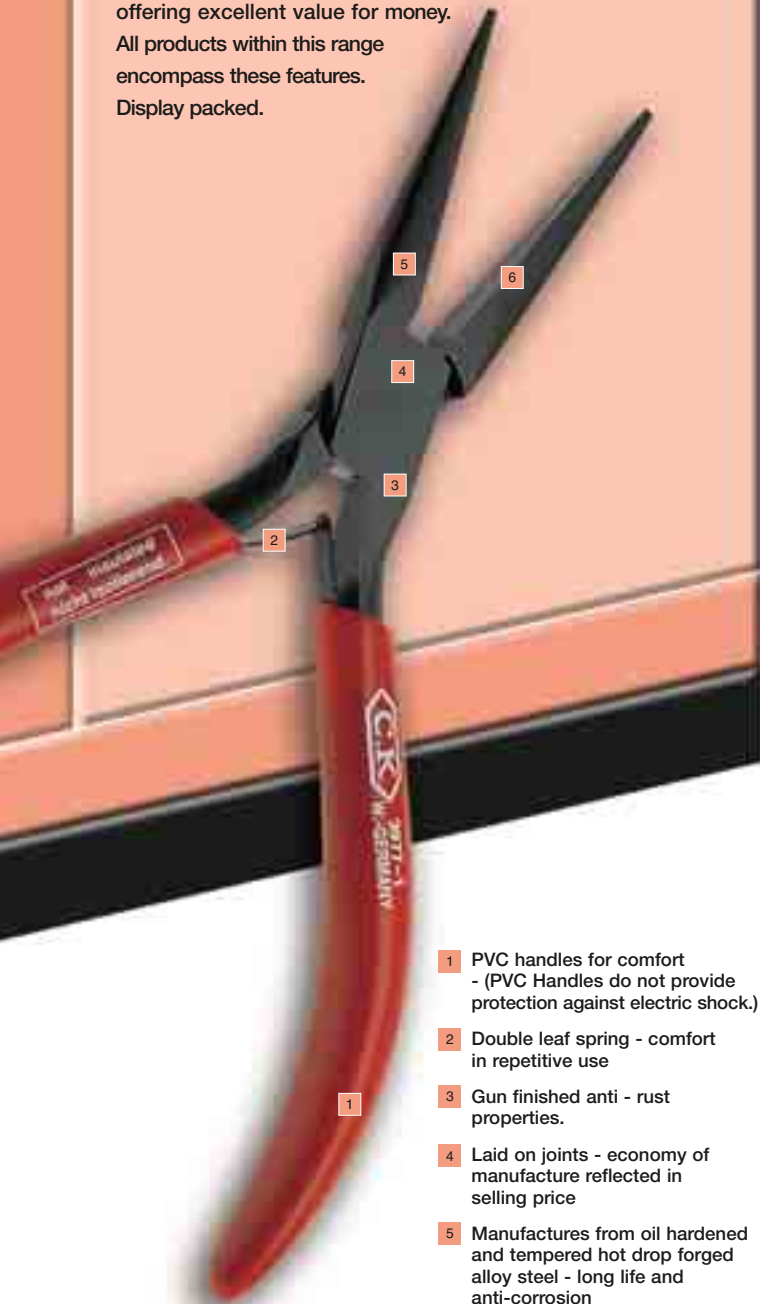

- 1 PVC handles for comfort - (PVC Handles do not provide protection against electric shock.)
- 2 Double leaf spring - comfort in repetitive use
- 3 Gun finished anti - rust properties.
- 4 Laid on joints - economy of manufacture reflected in selling price
- 5 Manufactures from oil hardened and tempered hot drop forged alloy steel - long life and anti-corrosion
- 6 Induction hardened cutting edges - ease of use and long life



Mini Bevel cut

Designed for the cutting of hard and soft steel wires as well as softer materials like copper wire and cables.



Extra Full Flush cut

For absolutely flat cuts of softer steel, copper wires and cables. Extremely fine.



Full Flush cut

Almost full flush cutting, with fine cutting edges. Side cutters for softer steel as well as copper wires and cables.



Smooth cut

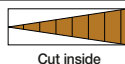

Cut inside

SIDE CUTTERS

3953

Oval head with mini bevel cut. Ideal for delicate work.



SIZE	CUTTING CAPACITY: mm Ø AWG			ITEM NO	BOX QTY	WEIGHT
	HARD WIRE	SOFT STEEL	COPPER			
120mm/4 3/4"	0.4/26	1.0/18	1.5/15	T3953	3	71g

SIDE CUTTERS

3955

Oval head. Heavy pattern. High cutting capacity.



SIZE	CUTTING CAPACITY: mm Ø AWG			ITEM NO	BOX QTY	WEIGHT
	HARD WIRE	SOFT STEEL	COPPER			
135mm/5 3/4"	0.7/21	1.5/15	2.0/12	T3955	3	101g

FLAT NOSE PLIER

3950



SIZE	ITEM NO	BOX QTY	WEIGHT
120mm/4 3/4"	T3950	3	75g

SNIPE NOSE PLIERS

3977

Long straight head snipe nose pliers. Smooth inside jaws.





SIZE	ITEM NO	BOX QTY	WEIGHT
150mm/6"	T3977 1	3	90g

TWEEZERS

C.K offer a comprehensive range of tweezers manufactured from top quality high grade tool alloy steel. Precision components which give long lasting performance with excellent results. The sprung steel is expertly balanced to avoid discomfort from repeated use. C.K offer a range of products for industrial and hobby use. For the complete C.K Tweezers selection, including the Precision and Ceramic Ranges, see the C.K Electronic catalogue.

UNIVERSAL					2301
Narrow, blunt points. Tip width 1mm. Finely milled inside jaws. Nickel plated with high polished finish. Serrated grips. Display packed.					
					
SIZE	ITEM NO	BOX QTY	WEIGHT		
115mm/4 1/2"	T2301	6	16g		

UNIVERSAL					2307
Tip width 3.5mm. Blunt points, finely milled inside jaws. Polished and nickel plated. Serrated grips. Display packed.					
					
SIZE	ITEM NO	BOX QTY	WEIGHT		
145mm/5 3/4"	T2307	6	28g		

UNIVERSAL					2309
Tip width 2mm. Blunt points with finely cross cut inside jaws. Polished and nickel plated. Serrated grips. Display packed.					
					
SIZE	ITEM NO	BOX QTY	WEIGHT		
140mm/5 1/2"	T2309	6	24g		



UNIVERSAL					2314
Tip width 1.5mm, fine blunt points, bent 15mm, finely milled inside jaws. With guide pins. Polished and nickel plated. Serrated grips. Display packed.					
					
SIZE	ITEM NO	BOX QTY	WEIGHT		
150mm/6"	T2314	6	23g		



PRECISION					2343
Made from SA stainless steel, anti-magnetic and acid resistant. Fine straight points. Satin polish, anti-glare finish. Display packed.					
					
SIZE	ITEM NO	BOX QTY	WEIGHT		
130mm/5 1/4"	T2343	3	24g		

PRECISION					2316
Made from SA stainless steel, anti magnetic and acid resistant. Extra fine straight points. Satin polish, anti glare finish. Display packed.					
					
SIZE	ITEM NO	BOX QTY	WEIGHT		
105mm/4 1/8"	T2316	6	19g		

PRECISION					2317
Made from SA stainless steel, anti magnetic and acid resistant. Extra fine bent points. Satin polish, anti glare finish. Display packed.					
					
SIZE	ITEM NO	BOX QTY	WEIGHT		
105mm/4 1/8"	T2317	6	17g		

PRECISION					2318
Made from SA stainless steel, anti magnetic and acid resistant. Extra fine straight points. Satin polish, anti glare finish. Display packed.					
					
SIZE	ITEM NO	BOX QTY	WEIGHT		
130mm/5 1/4"	T2318	6	24g		

UNIVERSAL TWEEZERS					72308
Tip width 3.5 mm. Blunt points, finely milled inside. Polished and fine nickel plated. Red PVC insulation with anti-slip horns to meet safety standards.					
VDE 0682/201, EN 60900, IEC 60900, ASTM F 1505-94					
					
					
					
SIZE	ITEM NO	BOX QTY	WEIGHT		
145 mm / 5 3/4"	T72308	3	45g		

UNIVERSAL TWEEZERS					72315
Tip width 1.5 mm. Fine blunt points, bent 15 mm, finely milled inside. Polished and fine nickel plated. Red PVC insulation with anti-slip horns to meet safety standards.					
VDE 0682/201, EN 60900, IEC 60900, ASTM F 1505-94					
					
					
					
SIZE	ITEM NO	BOX QTY	WEIGHT		
150 mm / 6"	T72315	3	36g		

FOR DISPLAY INFORMATION SEE PAGES 214-219

WRENCHES

A comprehensive and sturdy selection for all uses.

SELF GRIP WRENCH				3630	
Hot drop forged chrome vanadium steel head and jaws. Black rust resistant epoxy coated finish. Both jaws concave, with cutter. Quick release. Display packed.					
					
SIZE	JAW CAPACITY Ø	ITEM NO	BOX QTY	WEIGHT	
250mm/10"	50mm/2"	T3630 10	3	570g	
2300mm/12"	65mm/2½"	T3630 12	3	930g	

SELF GRIP WRENCH				3638	
Hot drop forged chrome vanadium steel lower jaw and head. Chrome vanadium steel upper jaw welded to pressed steel frame. Straight and curved jaw design for gripping round and square material. Black rust resistant epoxy coated finish. Quick release. Display packed.					
					
SIZE	JAW CAPACITY Ø	ITEM NO	BOX QTY	WEIGHT	
180mm/7"	max 25mm ROUND OBJECT	T3638 07	3	310g	
250mm/10"	max 35mm FLAT OBJECT	T3638 10	3	510g	

SELF GRIP WRENCH				3641	
Hot drop forged chrome vanadium steel head and jaws. Black rust resistant epoxy coated finish. Both jaws straight. Quick release device. Display packed.					
					
SIZE	JAW CAPACITY Ø	ITEM NO	BOX QTY	WEIGHT	
180mm/7"	35mm/1½"	T3641 07	3	350g	
250mm/10"	40mm/1½"	T3641	3	540g	

IMMERSION HEATER SPANNER				4347	
For the installation and removal of electric immersion heaters fitted in domestic hot water cylinders. Soft grip handle for comfort and maximum torque, whilst the one piece manufacture enables full transmission of power to the spanner. Display packed.					
					
SIZE	ITEM NO	BOX QTY	WEIGHT		
85mm	T4347	3	360g		

FOR DISPLAY INFORMATION SEE PAGES 214-219

STILLSON WRENCH				3735	
Professional quality drop forged hardened and tempered wrench. Patented head design which allows greater torque before deformation. Serrated hardened jaws give secure grip and long life. Heat treated textured, durable paint finish gives greater control. Conforms to torque requirements of BS standard. With hanging hole in handle. Sold loose.					
					
SIZE	ITEM NO	BOX QTY	WEIGHT		
250mm/10"	T3735 250	3	650g		
300mm/12"	T3735 300	3	800g		
350mm/14"	T3735 350	3	1.4kg		
450mm/18"	T3735 450	3	1.9kg		
600mm/24"	T3735 600	3	3.8kg		

BASIN WRENCH				4311	
Square, telescopic pipe, length adjustable in 4 different positions between appr. 275 and 460mm total length. Sliding T-handle. Toothed, spring loaded self-adjusting forged steel jaws, swivelling by 180°. Display packed.					
					
ITEM NO	BOX QTY	WEIGHT			
T4311	3	703g			

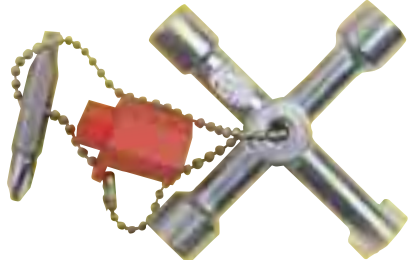
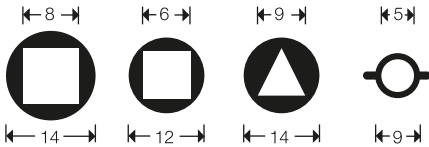
SWITCH KEY UNIVERSAL WRENCH				4451	
A multi-purpose tool designed for use on locking systems of electric, gas and water cupboards in industry, and / or technical equipment in buildings such as air conditioning, ventilation systems, stop valves, mains consoles etc. Manufactured from zinc-die cast, the tool comprises 6 mm square, 8 mm square, 9 mm triangular and 5 mm double pin type keys. The key is also supplied with a tooling adaptor for ¼" hex. bits, complete with double ended screwdriver bit 7mm slotted x Phillips no.2. Display packed.					
					
PATENT NO. GB 231 8316					
					
ITEM NO	BOX QTY	WEIGHT			
T4451	6	80g			

WATERPUMP PLIERS

For adjustable spanners/wrenches see pages 120-121.

MAXI WATERPUMP PLIER 3657

The only waterpump plier required in a toolbox. Patented design plier which has fine press button adjustment to 11 positions, this ensures fast working. Extra large gripping capacity of over 50mm/2". Ideal for almost any application. Manufactured from quality chrome vanadium steel and box jointed design provide strength and durability. Slim head and jaws allow work in confined spaces. Contoured, antislip, long handles provide a tool which is comfortable and easy to use. Display packed.

DIN 5231D DIN 5232 ISO 8976GS

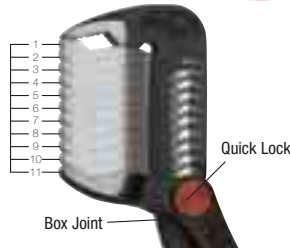

SIZE	MAX JAW CAPACITY Ø	ITEM NO	BOX QTY	WEIGHT
250mm/10"	50mm/2"	T3657 250	3	300g
300mm/12"	65mm/2½"	T3657 300	3	530g

WATERPUMP PLIERS 3659A

Manufactured from hot drop forged chrome vanadium steel, oil hardened and tempered to specified levels. Box jointed construction gives accuracy and long life. Slim head design for use in confined spaces. Parallelogram shaped jaws grip well on smooth and irregular surfaces. 7 position adjustment. Built in stop prevents finger nipping. Black stove enamel finish with PVC coated handles. Manufactured to DIN 5231D and ISO 8976 specifications. Display packed.

DIN 5231D, ISO 8976



SIZE	JAW CAPACITY: Ø/AWG	ITEM NO	BOX QTY	WEIGHT
175mm/7"	30mm/1½"	T3659A 175	3	170g
250mm/10"	32mm/2¼"	T3659A 240	3	326g
300mm/12"	38mm/1"	T3659A 300	3	614g
400mm/16"	64mm/2½"	T3659A 400	3	1244g

VDE WATERPUMP PLIERS 3979

As 3659A but manufactured to VDE 0680/201, IEC 900 and EN 60900 specifications. Double dip coated handles with shoulders. Display packed.

VDE 0680/201 IEC 60900 EN 60900 DIN 5231D ISO 8976 ASTM-F 1505-94



SIZE	JAW CAPACITY: Ø/AWG	ITEM NO	BOX QTY	WEIGHT
250mm/10"	32mm/1¼"	T3979 250	3	428g

WATERPUMP PLIERS 3651

Non slip groove joint design grips positively on round, square, triangular, flat and irregular surfaces. 6 position adjustment. Built in stop prevents finger nipping. Made with all Classic features to DIN 5321F specifications. Display packed.

DIN 5231D DIN 5232 ISO 8976GS



SIZE	JAW CAPACITY Ø	ITEM NO	BOX QTY	WEIGHT
250mm/9"	38mm/1½"	T3651 09	3	380g

PLIERS WRENCHES 3656

Capacity scale on joint. Hot drop forged Chrome-Vanadium Alloy Steel, fully oil hardened and tempered. Matt chrome plated. Textured anti-slip grips for comfortable and safe use. Self adjusting jaws for optimised grip and pressure. Extra large capacity 0 - 53mm, with scale on joint. For work on sensitive, finished surfaces, I.E. turned, chrome or nickel plated, burnished. The smooth jaw surface offers best protection against scratching. Quick-Lock push-button adjustment into 10 positions. Extra slim and light box joint construction for long term life and easy access into confined spaces.



Max. mm 20 36 M24 53 53

SIZE	MAX CAPACITY	ITEM NO	BOX QTY	WEIGHT
250mm/10"	Round: 20mm. Nuts across flats: 36mm/M24. Parallel jaw opening: 53mm.	T3656 250	3	370g

UTILITY PLIERS 3653

A new concept based on our bestseller 3659A but lighter, slimmer and wider. Extra wide jaw opening in 11 positions - larger capacity than any other standard patterns offer. Very slim jaw & joint design - for easy work in confined spaces. Light weight - for more comfort. Hot drop forged Chrome-Vanadium steel, hardened and tempered - extra strength for durability. Contoured and antislip dip coated handles - more comfort and safety in use. Made in Germany - fully guaranteed. Display packed



SIZE	MAX JAW OPENING	ITEM NO	BOX QTY	WEIGHT
10"/250 mm	2"/ mm	T3653 10	6	300g
12"/300 mm	2½"/65 mm	T3653 12	3	530g

SPECIALIST PLIERS

A high quality range for all specialists gripping and cutting applications.

TILE CUTTING PLIERS 1537H

Hot drop forged, tungsten tipped for strength and durability. Jaws 15mm wide. With spring and red PVC handles. Display packed.



SIZE	ITEM NO	BOX QTY	WEIGHT
200mm/8"	T1537H	3	370g

TILE CUTTING/BREAKING PLIERS 1538

Galvanised pressed steel frame with plastic grips. Tile is scored by the wheel and is then broken by the pressure of the anvil on both sides of the score. Complete with 14mm Ø tungsten carbide wheel (No.1573). Display packed.



SIZE	ITEM NO	BOX QTY	WEIGHT
215mm/8½"	T1538	3	255g

SPARE TUNGSTEN WHEEL 1573

For 1538 and tile cutter, 1593, 1596

ITEM NO	BOX QTY	WEIGHT
T1573	6	8g

OUR CUSTOMERS ARE CURRENTLY ENJOYING:

- 98% stock availability
- 2-3 day delivery
- Quality products at affordable prices

TILE NIBBLING PLIERS 1539H

Made from hot drop forged chrome vanadium steel for strength and long life. Tungsten tipped jaws for shaping tiles. With spring and red PVC grips. Display packed.



LENGTH	ITEM NO	BOX QTY	WEIGHT
190mm/7½"	T1539H	3	230g

PUNCH PLIERS 3817

Made from special hardened steel for greater load capacity. Brass anvil with 6 punch revolving head. Size of punch in use clearly shown. Punch capacity 2mm to 4.5mm. Closing catch with auto opening function. Rust resistant coating. Suitable for leather, plastic, card etc. Display packed.



SIZE	ITEM NO	BOX QTY	WEIGHT
220mm/8¾"	T3817	3	280g

CONTACT NOS:

IRELAND Tel: +353 (0) 1•8851669
Fax: +353 (0) 1•8851670 dublin-sales@ck-tools.com

FRANCE No. azur +33 (0) 810•000044 Fax: +33 (0) 810•000357

USA Tel: +1 866 484 5943 Fax: +1 630 953 2686 CKUSANICK@aol.com

GERMANY Tel: +49 (0) 202•89030 Fax: +49 (0) 202•80715 info@ck-tools.de

FOR DISPLAY INFORMATION SEE PAGES 214-219

FENCING PLIERS

1. Top opening in head closes around staple. Exerting leverage against the post, staple pulls out easily.
2. The special jaws between the handles grip the wire firmly for stretching it tight against the post before stapling.
3. Sharp, extra long, hardened hook will dig out and remove the oldest and most stubborn staples.
4. Lower opening in head holds wire firmly for twisting while stretching from post to post.
5. Two wire cutter 5mm Ø capacity.
6. Fixing of staple.

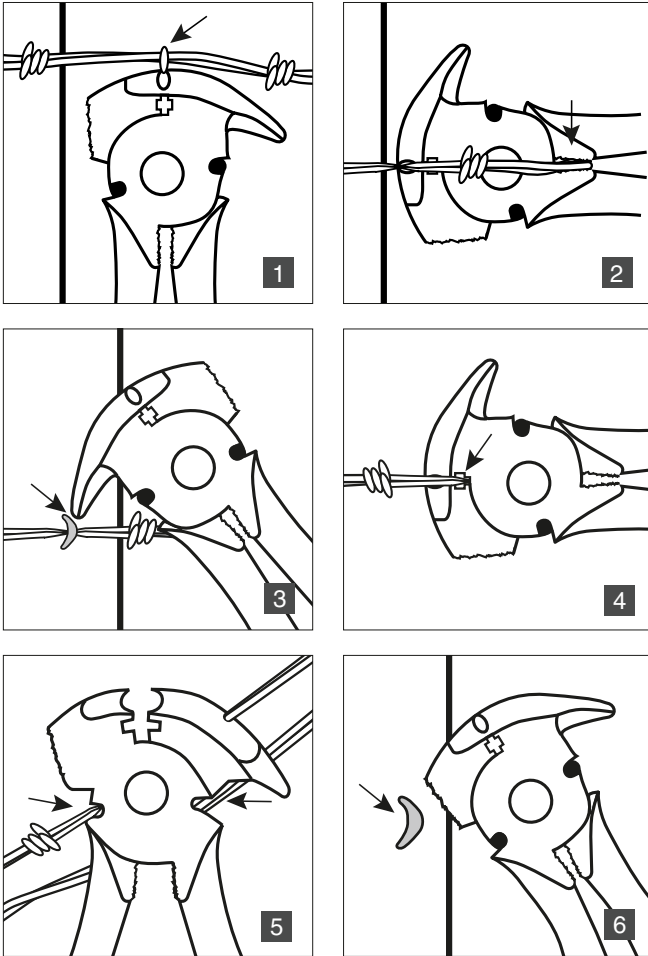

FENCING PLIERS 3866

Original German pattern. Heavy duty, multi-purpose tool. High grade steel with polished head and red PVC handles. Hammers and draw staples, strains, twists and splices wire. Two shearing cutters for wire up to 5mm^{9/16}" Ø. Display packed.

DIN 5232



SIZE	ITEM NO	BOX QTY	WEIGHT
270mm/10 3/4"	T3866	3	690g

AUTOMATIC WIRE STRIPPER 3942

Strips, cuts and crimps, ideal for professional or DIY use. Wire is stripped automatically in a single motion without adjustment. Crimping of insulated and non-insulated terminals. Micro adjustment knob allows wires smaller than 0.2mm² to be stripped. Hardened steel blades ensures a long life. Easy action with long comfortable handles. Display packed.

- Capacities:
- Stripping - 0.2 - 6.0mm² copper or aluminium wire
 - Cutting - Wire HRC 40-50
 - Crimping - 1.5, 2.5, 6.0mm insulated terminals 1.5, 2.5, 4.0, 6.0mm non insulated terminals and non insulated spades



ITEM NO	BOX QTY	WEIGHT
T3942	2	354g

PRECISION WIRE STRIPPER 3757

Specification as 3756 below but adjustable. In 3 sizes, each adjustable to 6 dia. 50mm scale with 1mm graduation. Front hole diameter for all sizes is 2mm^{5/64}".



SIZE	ADJUST TO: mm / AWG	ITEM NO	BOX QTY	WEIGHT
1	0.12/36, 0.16/34, 0.20/32, 0.35/30, 0.30/28, 0.40/26,	T3757 1	3	26g
2	0.25/30, 0.30/28, 0.40/26, 0.50/240, 0.60/22, 0.80/200,	T3757 2	3	26g
3	0.30/28, 0.40/26, 0.50/24, 0.60/22, 0.80/20, 1.00/18,	T3757 3	3	26g

PLCC EXTRACTOR 2371

Universal extractor tool for all PLCC components, with stainless steel hooks and self opening spring. Non overlapping handles for easy, safe use. Display packed.





SIZE	ITEM NO	BOX QTY	WEIGHT
100mm/4"	T2371	3	25g

RATCHET CRIMPING TOOLS

C.K ratchet crimping tools are specially designed for electricians, contractors and installers who require a high quality crimping tool which they can rely on for long term, safe and precise crimping of mechanical and electrical connections.

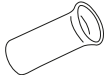
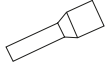
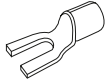
- Manufactured from fully hardened carbon alloy steel with comfort grips.
- Quick release lever.
- Pressure adjustment.
- High compression pressure and deadlock systems ensures safe, constant, precise crimping.
- Precision polished dies providing quality crimps and safe connections.
- Ground edges for comfort and safety.
- Die cast heads 100% tested for correct sizing.
- Guarantee 30,000 crimps per tool.
- Tested up to 40,000.
- Display packed.

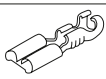
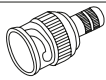
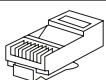
	For cable links without insulation
	For cable links with insulation
	Non-insulated terminals
	Insulated terminals
	Non-insulated open barrel connectors
	COAX-, BNC-, TNC-connectors
	Modular plugs

RATCHET CRIMPING PLIERS 3678

For cable links, insulated & non-insulated.



SIZE	CAPACITY: mm ² Ø/AWG	ITEM NO	BOX QTY	WEIGHT
190mm/7½"	0.14-2.5/26-14	T3678	3	375g

RATCHET CRIMPING PLIERS 3679

For cable links, insulated & non-insulated.



SIZE	CAPACITY: mm ² Ø/AWG	ITEM NO	BOX QTY	WEIGHT
190mm/7½"	0.25-6/20-10	T3679	3	379g

RATCHET CRIMPING PLIERS 3683

For cable links, insulated & non-insulated.



SIZE	CAPACITY: mm ² Ø/AWG	ITEM NO	BOX QTY	WEIGHT
230mm/9"	10-25/8-3	T3683	3	

RATCHET CRIMPING PLIERS 3680

For insulated terminals. Colour coding for easy die selection.



SIZE	CAPACITY: mm ² Ø/AWG	ITEM NO	BOX QTY	WEIGHT
190mm/7½"	0.25-2.5/24-13	T3680	3	373g

RATCHET CRIMPING PLIERS 3682

For insulated terminals. Colour coding for easy die selection.



SIZE	CAPACITY: mm ² Ø/AWG	ITEM NO	BOX QTY	WEIGHT
220mm/8¾"	0.5-6.0/20-10	T3682	3	

RATCHET CRIMPING PLIERS 3696

For non-insulated terminals.



SIZE	CAPACITY: mm ² Ø/AWG	ITEM NO	BOX QTY	WEIGHT
190mm/7½"	0.25-2.5/24-13	T3696	3	367g

RATCHET CRIMPING PLIERS		3697			
For non-insulated terminals.					
SIZE	CAPACITY: mm ² Ø/AWG	ITEM NO	BOX QTY	WEIGHT	
230mm/9"	1.5-10/16-8	T3697	3	563g	

RATCHET CRIMPING PLIERS FOR MODULAR PLUGS		3852			
For modular plugs 8P8C (RJ-45), 6P6C (RJ-11). Cuts, strips and crimps without changing the die. Compact and handy. Ergonomic comfortable plastic handles. Deadlock system for constant, safe and precise crimping. Display packed with full instructions.					
ITEM NO	BOX QTY	WEIGHT			
T3852	1	320g			

RATCHET CRIMPING PLIERS		3681			
4P2C, 4P4C, 6P4C (RJ11), 6P6C (RJ12), 8P8C (RJ45) and 6P6C/Offset (Dec) - Cuts, strips & crimps all types without change of die. Built in stripper on front, cutter on reverse. Guide for precise stripping and quick release lever/screw. Patented design.					
SIZE	CAPACITY: mm ² Ø/AWG	ITEM NO	BOX QTY	WEIGHT	
200mm/8"		T3681	3	547g	

RATCHET CRIMPING PLIERS		3698			
For COAX-BNC and TNC connectors.					
SIZE	FOR	ITEM NO	BOX QTY	WEIGHT	
230mm/9"	58, 59, 62, 8X, 140, 141, 174 210, 223, 303, 400 Fibre Optic, Belden 8279	T3698	3	575g	

NON-RATCHET CRIMPING TOOLS

CRIMPING TOOL		3695			
Non-ratchet action, specially hardened steel crimper with soft comfort grips. Ideal tool for occasional use when preparing electrical connections. Four functions in the one tool namely-					
* Wire Cutting		- Soft wire only.			
* Crimping		- Insulated terminals 1.5, 2.5, 6.0mm Ø			
		- Non-insulated terminals 1.5, 2.5, 4 - 6mm Ø			
* Bolt Shearing		- 2.6, 3.0, 3.5, 4.0, 5.0mm Ø			
* Wire Stripping		- 0.75, 1.0, 1.5, 2.5, 4.0, 6.0mm Ø			
Display packed.					
SIZE	ITEM NO	BOX QTY	WEIGHT		
250mm	T3695	3	256g		

CRIMPING PLIERS FOR CABLE LINKS		3645			
High alloy carbon Steel, drop forged. Matt chrome plated. red thermoplastic grips with anti-slip horns.					
SIZE	CAPACITY: mm ² Ø/AWG	ITEM NO	BOX QTY	WEIGHT	
145mm/9 1/2"	0.25-2.5/23-13	T3645	3	158g	

CRIMPING PLIERS FOR CABLE LINKS		3646			
High alloy carbon Steel, drop forged. Matt chrome plated. Red thermoplastic grips.					
SIZE	CAPACITY: mm ² Ø/AWG	ITEM NO	BOX QTY	WEIGHT	
220mm/8 1/2"	0.5-16/20-5	T3646	3	252g	

FOR DISPLAY INFORMATION SEE PAGES 214-219

CIRCLIP PLIERS

C.K offer two ranges of professional circlip pliers ensuring the widest choice. Manufactured in Germany to the toughest quality standards. Both hot drop forged, chrome vanadium steel, hardened and tempered with precision ground and fully hardened points. Specifically designed tips prevent slippage whilst in use. Gun finished for long life. Pliers for outside circlips are produced to DIN 5254 for circlips against DIN 471. Pliers for inside circlips are produced to DIN 5256 for circlips against DIN 472.



FOR DISPLAY INFORMATION SEE PAGES 214 -219

OUTSIDE CIRCLIP PLIERS - BENT						3713
Leaf springs and bent tips. Display packed. CHEQUERED						
						DIN 5254B
SIZE	CAPACITY	DIN CODE	ITEM NO	BOX QTY	WEIGHT	
140mm/5½"	10-25mm	A11	T3713 5	3	100g	
180mm/7"	19-60mm	A21	T3713 7	3	160g	
220mm/8¾"	40-100mm	A31	T3713 8	3	250g	
300mm/12"	85-140mm	A41	T3713 11	1	514g	

OUTSIDE CIRCLIP PLIERS - STRAIGHT						3711
Straight points with leaf springs. Display packed. CHEQUERED						
						DIN 5254A
SIZE	CAPACITY	DIN CODE	ITEM NO	BOX QTY	WEIGHT	
140mm/5½"	10-25mm	A1	T3711 5	3	100g	
180mm/7"	19-60mm	A2	T3711 7	3	160g	
220mm/8¾"	40-100mm	A3	T3711 8	3	250g	
300mm/12"	85-140mm	A4	T3711 11	1	514g	

OUTSIDE CIRCLIP PLIERS - BENT						3713A
DIPPED						
						DIN 5254B
SIZE	CAPACITY	DIN CODE	ITEM NO	BOX QTY	WEIGHT	
125mm/5"	10-25mm	A11	T3713A 125	3	85g	
165mm/6½"	19-60mm	A21	T3713A 165	3	185g	
220mm/8¾"	40-100mm	A31	T3713A 210	3	240g	
300mm/12"	85-140mm	A41	T3713A 300	3	470g	

OUTSIDE CIRCLIP PLIERS - STRAIGHT						3711A
DIPPED						
						DIN 5254A
SIZE	CAPACITY	DIN CODE	ITEM NO	BOX QTY	WEIGHT	
140mm/5½"	10-25mm	A1	T3711A 135	3	85g	
180mm/7"	19-60mm	A2	T3711A 180	3	185g	
225mm/8¾"	40-100mm	A3	T3711A 225	3	240g	
320mm/12½"	85-140mm	A4	T3711A 320	3	470g	

OUTSIDE FINE POINTED - BENT						3713 0
With very fine points for use with small circlips. Bent tips. Display packed. CHEQUERED						
						DIN 5254B
SIZE	CAPACITY	DIN CODE	ITEM NO	BOX QTY	WEIGHT	
140mm/5½"	3-10mm	A01	T3713 0	3	100g	

OUTSIDE FINE POINTED- STRAIGHT						3711-0
For use with very small circlips. Straight points. Display packed. CHEQUERED						
						DIN 5254A
SIZE	CAPACITY	DIN CODE	ITEM NO	BOX QTY	WEIGHT	
140mm/5½"	3-10mm	A0	T3711 0	3	100g	

OUTSIDE FINE POINTED - BENT						3713A 0
DIPPED						
						DIN 5254B
SIZE	CAPACITY	DIN CODE	ITEM NO	BOX QTY	WEIGHT	
125mm/5"	3-10mm	A01	T3713A 0	3	85g	

OUTSIDE FINE POINTED- STRAIGHT						3711A-0
DIPPED						
						DIN 5254A
SIZE	CAPACITY	DIN CODE	ITEM NO	BOX QTY	WEIGHT	
135mm/5¾"	3-10mm	A0	T3711A 0	3	85g	



Chequered with leaf spring - Traditional professional pattern with finely chequered handles providing a non-slip grip even in a workshop environment. Leaf spring is welded to the handle giving durability and smooth action.

Sizes and capacities are for guidance only.

ADJUSTABLE CIRCLIP PLIER SET		3716	
Ideal DIY product. The plier has a push button adjustment which adapts the product for use on both inside and outside circlips, without the need to change the heads. Gun finished head with comfort soft grips. Set includes one each inside and outside circlips 12, 14, 16, 18, 20 and 22mm. Sold in sturdy display/storage box. Full instructions on pack.			
	ITEM NO	BOX QTY	WEIGHT
	T3716	3	280g

INSIDE CIRCLIP PLIERS - BENT		3712			
With bent tips. Display packed. CHEQUERED					
DIN 5256D					
SIZE	CAPACITY	DIN CODE	ITEM NO	BOX QTY	WEIGHT
140mm/5½"	12-25mm	J11	T3712 5	3	94g
180mm/7"	19-60mm	J21	T3712 7	3	150g
220mm/8¾"	40-100mm	J31	T3712 8	3	230g
300mm/12"	85-140mm	J41	T3712 11	1	450g

INSIDE CIRCLIP PLIERS - STRAIGHT		3710			
With straight, accurately ground tips. Display packed. CHEQUERED					
DIN 5256C					
SIZE	CAPACITY	DIN CODE	ITEM NO	BOX QTY	WEIGHT
140mm/5½"	12-25mm	J1	T3710 5	3	95g
180mm/7"	19-60mm	J2	T3710 7	3	150g
220mm/8¾"	40-100mm	J3	T3710 8	3	230g
300mm/12"	85-140mm	J4	T3710 11	1	440g

INSIDE CIRCLIP PLIERS - BENT		3712A			
DIPPED					
DIN 5256D					
SIZE	CAPACITY	DIN CODE	ITEM NO	BOX QTY	WEIGHT
125mm/5"	12-25mm	J11	T3712A 125	3	85g
165mm/6½"	19-60mm	J21	T3712A 165	3	190g
220mm/8¾"	40-100mm	J31	T3712A 210	3	240g
295mm/11½"	85-140mm	J41	T3712A 295	3	445g

INSIDE CIRCLIP PLIERS - STRAIGHT		3710A			
DIPPED					
DIN 5256C					
SIZE	CAPACITY	DIN CODE	ITEM NO	BOX QTY	WEIGHT
140mm/5½"	12-25mm	J1	T3710A 140	3	85g
180mm/7"	19-60mm	J2	T3710A 180	3	190g
225mm/8¾"	40-100mm	J3	T3710A 225	3	240g
315mm/12½"	85-140mm	J4	T3710A 315	3	445g

INSIDE FINE POINTED - BENT		3712-0			
For use with very small circlips. Bent tips. Display packed. CHEQUERED					
DIN 5256D					
SIZE	CAPACITY	DIN CODE	ITEM NO	BOX QTY	WEIGHT
140mm/5½"	8-13mm	J01	T3712 0	3	194g

INSIDE FINE POINTED - STRAIGHT		3710-0			
For use with very small circlips. Display packed. CHEQUERED					
DIN 5256C					
SIZE	CAPACITY	DIN CODE	ITEM NO	BOX QTY	WEIGHT
140mm/5½"	8-13mm	J0	T3710 0	3	94g

INSIDE FINE POINTED - BENT		3712A-0			
DIPPED					
DIN 5256D					
SIZE	CAPACITY	DIN CODE	ITEM NO	BOX QTY	WEIGHT
125mm/5"	8-13mm	J01	T3712A 0	3	85g

INSIDE FINE POINTED - STRAIGHT		3710A-0			
DIPPED					
DIN 5256C					
SIZE	CAPACITY	DIN CODE	ITEM NO	BOX QTY	WEIGHT
140mm/5½"	8-13mm	J0	T3710A 0	3	85g

RIVETING PLIERS

Manufactured in Europe to professional quality standards, C.K riveters have three jaws instead of the usual two. Advantages of this are:-

- Tighter grip of the rivet stem, easier operation with no rivet slippage.
- The jaws have a longer life due to less wear of jaw teeth by metal dust.
- Gripping force is applied evenly across three jaws avoiding breakage of the inner tube.

The C.K three jaw riveter is 50% stronger than the two jaw equivalent. Even 4.8mm ($\frac{3}{16}$ ") rivets are set easily. Riveter nose bushes and C.K Rivet stems are colour coded to ease selection of correct items.

ALUMINIUM RIVETS

3819A

Display packed in 50's in sturdy storage box. (4.8mm in 40's).



SIZE	LENGTH	ITEM NO	BOX QTY	WEIGHT
3.15x6mm/ $\frac{1}{8}$ x $\frac{1}{4}$ "	Short	T3819A 408	6	80g
3.15x9mm/ $\frac{1}{8}$ x $\frac{3}{8}$ "	Medium	T3819A 412	6	80g
3.15x12mm/ $\frac{1}{8}$ x $\frac{1}{2}$ "	Long	T3819A 415	6	80g
4x6mm/ $\frac{5}{16}$ x $\frac{1}{4}$ "	Short	T3819A 508	6	110g
4x9mm/ $\frac{5}{16}$ x $\frac{3}{8}$ "	Medium	T3819A 512	6	115g
4x12mm/ $\frac{5}{16}$ x $\frac{1}{2}$ "	Long	T3819A 515	6	120g
4.8x9mm/ $\frac{3}{16}$ x $\frac{3}{8}$ "	Medium	T3819A 612	6	120g
4.8x12mm/ $\frac{3}{16}$ x $\frac{1}{2}$ "	Long	T3819A 615	6	130g
4.8x16mm/ $\frac{3}{16}$ x $\frac{3}{4}$ "	Ex long	T3819A 620	6	150g

WASHERS

3824

For use with C.K Rivets. Sizes given are internal diameter. Packed in 100's. Display packed.



SIZE	ITEM NO	BOX QTY	WEIGHT
3.15mm/ $\frac{1}{8}$ "	T3824 12	6	160g
4mm/ $\frac{5}{16}$ "	T3824 15	6	160g
4.8mm/ $\frac{3}{16}$ "	T3824 18	6	160g

HAND RIVETING PLIERS

3820

Heavy duty pattern for aluminium and steel rivets up to 4.8mm ($\frac{3}{16}$ "). Frame manufactured from pressed steel, hardened and tempered for total strength. Self opening inside spring. Closing catch with incorporated spanner for bush changing. Supplied with 3 colour coded interchangeable nose bushes to accept 3.15mm ($\frac{1}{8}$ "), 4mm ($\frac{5}{16}$ "), 4.8mm ($\frac{3}{16}$ "), rivets. Bushes colour coded to aid correct rivet selection when using C.K rivets. Moulded comfort anti slip handles. Display packed.



SIZE	ITEM NO	BOX QTY	WEIGHT
260mm/10 $\frac{1}{2}$ "	T3820	1	880g

LAZY TONG RIVETER

3822A

The new ANTI-SHOCK Lazy Tong Riveter protects the user against injury to wrist, elbow and shoulder caused by shock when setting rivets. A new system of built-in shock absorbers neutralises this hazard. High grade alloy steel jaws and collet. Simple replacement of collet by unscrewing nose with added spanner. Comfort shape soft grip handle. For all aluminium and steel rivets 2.4, 3.15, 4.0, 4.8 and 6.0mm. 3 Jaws for perfect grip. In display box.

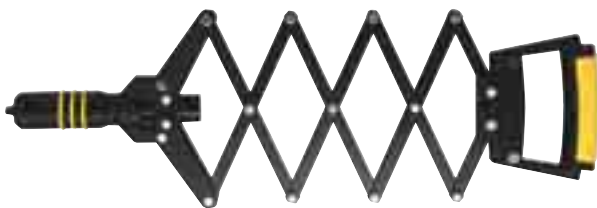

SIZE	ITEM NO	BOX QTY	WEIGHT
Open 780mm/32 $\frac{1}{2}$ " Closed 305mm/12"	T3822A	1	2.25kg

HAND RIVETING PLIERS

3826

Compact one handed riveter. Pressed steel frame with enamel finish. 3 interchangeable colour coded nose bushes to accept 3.15mm ($\frac{1}{8}$ ") and 4mm ($\frac{5}{16}$ ") aluminium and steel rivets. Comfort textured handles. Display packed.



SIZE	ITEM NO	BOX QTY	WEIGHT
230mm/9"	T3826	1	540g

RIVETING DISPLAY STAND 3825

Free standing or wall mounted wire display stand.



CONTENTS					
CATALOGUE NO	SIZE	DESCRIPTION		QTY	(OF EACH SIZE)
3820		Riveting pliers		3	
3820AS		Riveting plier sets		3	
3819A	all 9 sizes	Aluminum rivets (boxed)		6	
3824	all 3 sizes	Washers (boxed)		3	

DIMENSIONS	DESCRIPTION	ITEM NO	BOX QTY	WEIGHT
570x530x330mm	Complete rivet plier stand	T3825LS	1	15g
	Empty stand	T3825L		
	Header for empty stand	T3825H		

RIVETING DISPLAY STAND 3827

Free standing wire display stand.



CONTENTS					
CATALOGUE NO	SIZE	DESCRIPTION		QTY	(OF EACH SIZE)
3820		Riveting Pliers		3	
3826		Hand Riveting Pliers		3	
3819A	all 9 sizes	Aluminium rivets (boxed)		6	
3824	all 3 sizes	Washers (boxed)		6	

SIZE	DESCRIPTION	ITEM NO	BOX QTY	WEIGHT
570 x 530 x 330mm	Complete rivet plier stand	T3827LS	1	13kg
	Empty stand	T3825L		
	Header for empty stand	T3825H		

RIVETING PLIERS KIT 3820AS

Kit containing: hand riveting pliers 3820 and 25 each of rivets: 3.15mm (1/8") short, 4.00mm (5/32") short, 4.8mm (3/16") medium. All contained in a tough, durable plastic storage carry case. Display packed.



ITEM NO	BOX QTY	WEIGHT
T3820AS	1	1.22kg

THE STEMS OF C.K RIVETS ARE COLOUR CODED FOR EASE OF SELECTION AND CORRECT USAGE.

3.15mm / 1/8" are colour coded **RED** - (Drill size 3.3mm / 1/8").

4mm / 5/32" are colour coded **GREEN** - (Drill size 4.2mm / 1/16").

4.8mm / 3/16" are colour coded **YELLOW** - (Drill size 5.2mm / 1/4").

CONTACT NOS:
IRELAND Tel: +353 (0) 1•8851669
 Fax: +353 (0) 1•8851670 dublin-sales@ck-tools.com
FRANCE No. azur +33 (0) 810•000044 Fax: +33 (0) 810•000357
USA Tel: +1 866 484 5943 Fax: +1 630 953 2686 CKUSANICK@aol.com
GERMANY Tel: +49 (0) 202•89030 Fax: +49 (0) 202•80715 info@ck-tools.de

FOR DISPLAY INFORMATION SEE PAGES 214-219

SPECIALIST CUTTERS

A high quality range for all specialist cutting applications.

PVC PIPE CUTTER 2238

Suitable for PVC Conduit Pipes and similar materials e.g. blue water main pipe, rubber hose, pneumatic pipe, electrical sleeving, etc. Razor sharp, stainless steel blade for effortless straight cuts. Strong, lightweight, glass fibre reinforced body with comfortable handle design. This tool provides easy one handed straight cutting. Display packed.



SIZE	CUTTING CAPACITY: Ø	ITEM NO	BOX QTY	WEIGHT
195mm/7 7/8"	26mm	T2238	3	170g

SPARE BLADE 2238 1

ITEM NO	BOX QTY	WEIGHT
T2238 1		

RATCHET PVC PIPE CUTTER 2239

Heavy duty pattern. For PVC conduit pipes and similar materials e.g. blue water main plastic pipe, rubber hose, pneumatic pipe, electrical sleeving, etc. Supplied with trunking adaptor allowing the square cutting of rectangular cross-section. Aluminium body with extra sharp stainless steel blade for effortless, straight cuts. The ratchet function alleviates the effort required. Display packed.

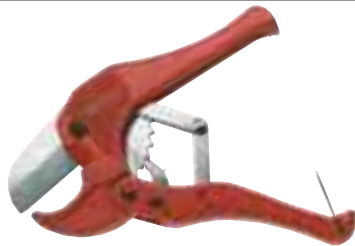

SIZE	CUTTING CAPACITY: Ø	ITEM NO	BOX QTY	WEIGHT
220mm/8 1/2"	32mm	T2239	3	300g

SPARE BLADE 2239B

ITEM NO	BOX QTY	WEIGHT
Z2239B	1	

RATCHET ACTION MULTI FUNCTION CUTTER 2240

The multi function cutter is supplied with five interchangeable anvils, flat, double radius, single radius, 90° square anvil and mitre anvil. By changing the anvil the item becomes multi functional. Anvils are changed easily and quickly by using the key provided. The heavy duty stainless steel blade, die cast aluminium anvil and gear cutting action ensure that materials are cut cleanly and quickly. Cuts hose, PVC pipe, mouldings, trim, doweling, etc. Not suitable for cable. Ergonomic handle design and matt finish for comfort in use. An ideal addition to any tool box. Display packed. Spare blade and anvils available.



ITEM NO	BOX QTY	WEIGHT
T2240	3	550G

PIPE CUTTER 2231

Adjustable pipe cutter with die cast, black lacquered body, hardened steel wheel and two flare groove rollers. With burr remover in end piece. Supplied with replaceable cutting wheel. For copper, brass, aluminium and thin walled steel pipes. Capacity: 3 - 30mm/1 1/8". Display packed.



SIZE	ITEM NO	BOX QTY	WEIGHT
145mm/5 3/4"	T2231	6	333g

MINI PIPE CUTTER 2232

Adjustable mini pipe cutter with die cast, black lacquered body, hardened steel wheel and two flare groove rollers. Suitable for small bore pipes and those with an outside diameter up to 25mm (1"). Fitted with replaceable C.K standard cutting wheel. For copper, brass, aluminium and thin walled steel pipes. Capacity: 3 - 25mm/1" - 1". Display packed.



SIZE	ITEM NO	BOX QTY	WEIGHT
65mm/2 1/2"	T2232	6	194g

SPARE CUTTING WHEEL 2235

Suitable for No.2231 and No.2232. Display packed.

DIAMETER	ITEM NO	BOX QTY	WEIGHT
19.5mm	T2235	6	4g

CABLE STRIPPERS "KABIFIX" 3330

Dual purpose cable stripper and plastic tube cutting tool. Cuts and removes insulation from cables, solid conductors and standardised wire. Cuts plastic tubes up to 1" diameter. Safe and fast stripping of cable insulation up to strong outer sheaths. Automatic change from circular to longitudinal cut, adjustable cutting depth, replaceable hardened blade, all ensure a fast easy cut. Sold loose.



SIZE	CAPACITY: Ø	ITEM NO	BOX QTY	WEIGHT
90mm/3 1/2"	6-28mm, 1" tube diameter	T3330	3	98g

SPARE BLADES FOR 3330 3331

ITEM NO	BOX QTY	WEIGHT
T3331	10	10g

CABLE CUTTER 73962A

For copper and alu wire up to 20 mm / 3/4" diam. Also for alu or steel wire mesh shielded cables. Double insulation - red over yellow.

VDE 0682/201, EN 60900, IEC 60900, ASTM-F 1505-94



AC1000V



SIZE	CUTTING CAPACITY: MM Ø CABLE	ITEM NO	BOX QTY	WEIGHT
215 mm / 8 1/2"	20mm / 3/4"	T73962A	1	306g

RATCHET CABLE CUTTER 3677

A compact, hand held heavy duty cutter with ratchet mechanism. For cable up to 32mm Ø. The blade is manufactured from top quality chrome molybdenum steel through hardened to HRC 52 for high durability. The profiled blade ensures an easy cut on hard drawn copper or aluminium cable, not to be used for steel or ACSR cable. Integral locking mechanism. Comfort, impact resistant handles with anti-slip shoulder guards. Not insulated. Display packed.



SIZE	ITEM NO	BOX QTY	WEIGHT
260mm/10½"	T3677	1	844g

SPARE BLADES FOR 3677

Spare blades for ratchet Cable Cutter No:3677. Two blades available, fixed and moving.

BLADE	ITEM NO	BOX QTY
Moving	Z3677 1	1
Fixed	Z3677 2	1

RATCHET CABLE CUTTER 73677

A compact, hand held heavy duty cutter with ratchet mechanism. For cable up to 32mm Ø. The blade is manufactured from top quality chrome molybdenum steel through hardened to HRC 52 for high durability. The profiled blade ensures an easy cut on hard drawn copper or aluminium cable, not to be used for steel or ACSR cable. Integral locking mechanism. Comfort, impact resistant handles with anti-slip shoulder guards. Double insulated – red over yellow. Display packed.

EN 60900, IEC 60900, ASTM F 1505-94



SIZE	ITEM NO	BOX QTY	WEIGHT
260mm / 10¼"	T73677	3	765g

CABLE CUTTERS 3963

Made from hot drop forged steel. Razor sharp, non squeeze, induction hardened cutting edges. Red PVC ergonomic non slip handles. Suitable for aluminium, copper and plastic sheathed cable, not for use on steel wire. Display packed.



SIZE	CUTTING CAPACITY: Ø CABLE	ITEM NO	BOX QTY	WEIGHT
220mm/8¾"	11mm	T3963	3	320g
240mm/9½"	13mm	T3963 240	3	370g

CABLE CUTTER 73963

Especially suitable for easy cutting of solid wire up to 11 mm / 7/16". Double insulation - red over yellow.

VDE 0682/201, EN 60900, IEC 60900, ASTM-F 1505-94



SIZE	CUTTING CAPACITY: MM Ø CABLE	ITEM NO	BOX QTY	WEIGHT
200 mm / 8"	11mm / 7/16"	T73963	1	373g

CABLE SNIPS 3753

For aluminium, copper and plastic sheathed cable, not for use on steel wire. Stainless steel, razor sharp, non squeeze cutting edges. PVC grips, coil spring and safety closing catch. Display packed.



SIZE	CUTTING CAPACITY: Ø CABLE	ITEM NO	BOX QTY	WEIGHT
170mm/6¾"	10mm	T3753	3	129g

HEAVY DUTY TOP CUTTERS 3987A

Manufactured from hot drop forged steel with induction hardened cutting edges. Black lacquered with red comfort PVC handles. Heavy duty pattern. Display packed.

DIN ISO 5478



SIZE	CUTTING CAPACITY: Ø WIRE HARD	ITEM NO	BOX QTY	WEIGHT
180mm/7"	2.5mm	T3987A 7	3	374g

TOP CUTTERS (STEEL FIXING) 3988

Manufactured from drop forged steel, oil hardened and tempered. Cutting edges induction hardened to approximately 60HRC for cutting hard or medium hard wire, including soft-annealed tin wire used for fixing steel reinforcing rods. Black polished head and comfort grips. Display packed.

DIN ISO 5748





SIZE	CUTTING CAPACITY: Ø WIRE SOFT MED/HARD HARD	ITEM NO	BOX QTY	WEIGHT
160mm/6"	4mm 2.8mm 2.3mm	T3988 160	3	190g
180mm/7"	4mm 3.2mm 2.5mm	T3988 180	3	290g
200mm/8"	4mm 3.5mm 2.8mm	T3988 200	3	360g

FOR DISPLAY INFORMATION SEE PAGES 214-219

STEEL FIXER'S NIPPERS				4112A	
Specially designed to bind, twist and cut wire, especially concrete reinforcing wire. Manufactured from drop forged high grade special steel. Black lacquered with polished jaws and PVC comfort handles. Display packed.					
DIN ISO 9243					
					
SIZE	CUTTING CAPACITY: Ø WIRE MED/HARD		ITEM NO	BOX QTY	WEIGHT
220mm/8 3/4"	2mm		T4112A 08	3	345g
250mm/10"	2mm		T4112A 10	3	445g

AIRCRAFT CABLE & WIRE ROPE CUTTER				3744	
Professional tool suitable for a multitude of uses agricultural, garden, automotive, marine etc. Cuts bowden cable; mild, hard and spring steel wire; barbed wire; fencing wire; stranded wire; wire rope; throttle, clutch, brake and speedo cables; CU & AL cables; round steel; steel rods etc. Angled blades for clean cut, spring, forged head comfort handles all ensure ease of use. Display packed.					
					
SIZE	CUTTING CAPACITY: Ø STEEL STR'ED MILD STR'ED HIGH TENSILE		ITEM NO	BOX QTY	WEIGHT
190mm/7 1/2"	6mm	4mm	T3744	3	310g

HEAVY DUTY WIRE CUTTERS				3961A	
Manufactured from hot drop forged steel with induction hardened cutting edges, centre cut. Black lacquered with red PVC comfort handles.					
					
SIZE	CUTTING CAPACITY: Ø WIRE PIANO		ITEM NO	BOX QTY	WEIGHT
200mm/8"	2mm		T3961A 08	3	340g
250mm/10"	3mm		T3961A 10	3	615g

'POCKET' BOLT CUTTERS				4371A	
Heads and cutting edges are manufactured from hot drop forged chrome vanadium steel. Induction hardened cutting edges, powder coated pressed steel handles and comfort grips. Toggle action gives improved performance. Wire safety closing loop. Display packed.					
					
SIZE	CUTTING CAPACITY: Ø 785Nmm ² 1226Nmm ² (51TONS SQ"/80KG mm ²) (80TONS SQ"/125KG mm ²)		ITEM NO	BOX QTY	WEIGHT
250mm/10"	5mm	3mm	T4371A	3	490g

TELESCOPIC CABLE CUTTER				39062	
Heavy Duty. For Aluminium and Copper cables up to 26 mm.					
					
LENGTH	ITEM NO	BOX QTY	WEIGHT		
350mm, infinitely variable up to 520 mm	T39062	1	1.4kg		

BOLT CUTTERS				4358	
Heads and cutting edges manufactured from hot drop forged chrome vanadium steel. Induction hardened cutting edges, steel tubular handles with plastic grips. 470, 630, 780 and 910mm have eccentric bolts for easy re-sharpening, and adjustment. For round material only. Spare cutting heads available. Ask for details.					
					
SIZE	CUTTING CAPACITY: Ø 785Nmm ² 1226Nmm ² (51TONS SQ") (80TONS SQ")		ITEM NO	BOX QTY	WEIGHT
340mm/13"	6mm	5mm	T4358 12	1	0.9kg
400mm/16"	7mm	6mm	T4358 15	1	1kg
450mm/18"	10mm	7mm	T4358 18	1	1.6kg
610mm/24"	11mm	9mm	T4358 25	1	2.3kg
800mm/31"	13mm	11mm	T4358 30	1	4.4kg
900mm/35"	15mm	13mm	T4358 36	1	4.7kg

FOR DISPLAY INFORMATION SEE PAGES 214 -219

TIN SNIPS 4536

Manufactured from hot drop forged high grade tool steel. Induction hardened cutting edges. Screw and bolt assembly for simple re-adjustment. Blue lacquered PVC coated handles. Stop pin between handles to prevent finger nipping. Fold away spring. Display packed.

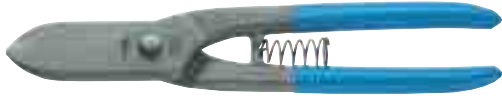

SIZE	ITEM NO	BOX QTY	WEIGHT
200mm/8"	T4536 08	3	339g
250mm/10"	T4536 10	3	490g
300mm/12"	T4536 12	3	700g

COMPOUND ACTION SNIPS 4537AL

Chrome Molybdenum steel jaws, drop forged and hardened to give long lasting strength and durability. Ideal for cutting titanium and stainless steel. Compound lever action eases cutting action. Chrome plated handles with comfort grips incorporating slip guards. Safety catch. Display packed. Cuts left from tight curves to straight. Red grips.

DIN 6438/11.71



SIZE	ITEM NO	BOX QTY	WEIGHT
240mm/10"	T4537AL	3	384g

COMPOUND ACTION SNIPS 4537AR

Specification as 4537AL but cuts right from tight curves to straight. Green grips.



SIZE	ITEM NO	BOX QTY	WEIGHT
240mm/10"	T4537AR	3	384g

COMPOUND ACTION SNIPS 4537AS

Specification as 4537AL but cuts straight or left and right hand in light stock. Yellow grips.



SIZE	ITEM NO	BOX QTY	WEIGHT
240mm/10"	T4537AS	3	384g

UNIVERSAL SNIPS 4507

Versatile snips for home, garden and workshop use. Cuts wire, paper, plastics, cloth, cardboard, thin tin sheet, flowers and many other materials. Stainless steel blades, plastic handles, coil spring and safety catch. Display packed.



SIZE	ITEM NO	BOX QTY	WEIGHT
190mm/7½"	T4507	6	108g

UNIVERSAL SNIPS 4533

Versatile cutters for home, garden, workshop and industry. Cuts paper, plastics, cloth, cardboard, tin sheet and soft wire. Stainless steel head with one serrated edge, polypropylene handles, coil spring and safety closing catch. Display packed.



SIZE	ITEM NO	BOX QTY	WEIGHT
150mm/6"	T4533 6	3	52g
190mm/7½"	T4533 75	3	108g

TUFF SNIPS 4506

The ultimate universal household, garden and workshop scissor. Cuts everything from poultry to plastic piping. An essential for First Aid Kits. Suitable for autoclave and dishwashers.



SIZE	ITEM NO	BOX QTY	WEIGHT
180mm/7"	T4506	6	60g

ELECTRICIAN'S SNIPS 4503

Stainless steel. Comfortable plastic bows. Sturdy wire and cable cutting scissor. Wire stripping notch. Also ideal for florists.



SIZE	ITEM NO	BOX QTY	WEIGHT
140mm/5½"	T4503	6	80g