

WELLER PROFESSIONAL SOLDERING TOOLS
PROFESSIONAL SOLDERING IRONS

W60P Series Irons

Line Voltage high quality portable tool
Controlled output and temperature
Iron features stainless steel modular plug-in heater construction
Nominal heat-up time w/CT5E7 tip = 110 seconds
Comes with CT5A7, 700°F 1/16" dia. screwdriver tip
Available with 3-wire cord as W60P-3

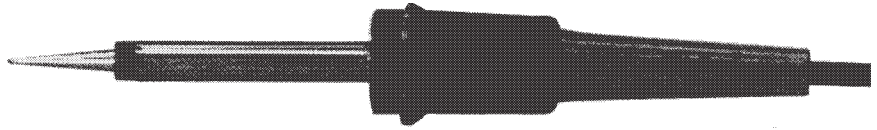

W60P - 60 Watt iron w/CT5A7 Tip Price \$76.60
W60P-3 - Same with 3-wire cord Price \$83.20

W100PG Series Irons

Line Voltage high quality portable tool
Controlled output and temperature
Iron features stainless steel modular plug-in heater construction
Nominal heat-up time w/CT6F7 tip = 110 seconds
Comes with CT6F7, 700°F 1/4" dia. screwdriver tip
Available with 3-wire cord as W100P-3

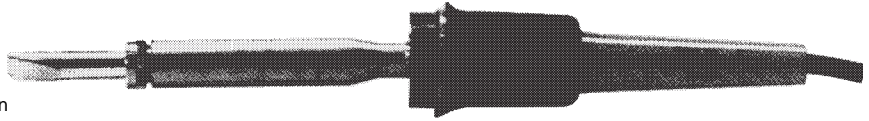

W100PG - 100 Watt iron w/CT6F7 Tip Price \$75.20
W100P-3 - Same with 3-wire cord Price \$89.72

CT Series Tips for W60P and W100PG Irons

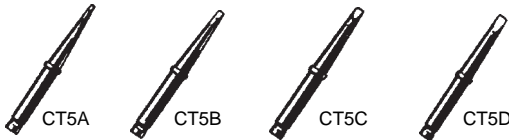

Part No.	Description	Temp °F	Tip Size "/mm	Reach "/mm	Price
CT5A7	W60P Screwdriver Tip	700	0.06/1.58	1.15/29.36	\$7.86
CT5A8	W60P Screwdriver Tip	800	0.06/1.58	1.15/29.36	7.86
CT5B7	W60P Screwdriver Tip	700	0.09/2.38	1.15/29.36	7.86
CT5B8	W60P Screwdriver Tip	800	0.09/2.38	1.15/29.36	7.86
CT5C6	W60P Screwdriver Tip	600	0.12/3.17	1.15/29.36	7.86
CT5C7	W60P Screwdriver Tip	700	0.12/3.17	1.15/29.36	7.86
CT5C8	W60P Screwdriver Tip	800	0.12/3.17	1.15/29.36	7.86
CT5D7	W60P Screwdriver Tip	700	0.18/4.74	1.15/29.36	7.86
CT5D8	W60P Screwdriver Tip	800	0.18/4.74	1.15/29.36	7.86

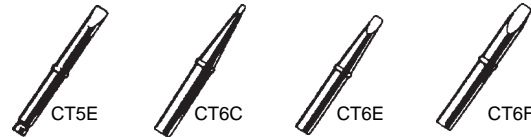

Part No.	Description	Temp °F	Tip Size "/mm	Reach "/mm	Price
CT5E6	W60P Screwdriver Tip	600	0.25/6.35	1.15/29.36	\$7.86
CT5E7	W60P Screwdriver Tip	700	0.25/6.35	1.15/29.36	7.86
CT5E8	W60P Screwdriver Tip	800	0.25/6.35	1.15/29.36	7.86
CT6C7	W100PG Screwdriver Tip	700	0.12/3.17	1.37/34.92	11.24
CT6E7	W100PG Screwdriver Tip	700	0.25/6.35	1.37/34.92	11.24
CT6E8	W100PG Screwdriver Tip	800	0.25/6.35	1.37/34.92	11.24
CT6F8	W100PG Screwdriver Tip	800	0.37/9.52	1.37/34.92	11.24

WP25, WP30, WP35 Series Irons

Ideal for a wide variety of electronic tasks
Interchangeable heater elements
Quick change knurled collar makes changing heater simple
Small lightweight handle with cushioned grip
3-Wire power cord for additional safety



WP25 - 25 Watt iron w/ET3 Tip Price \$40.08
WP30 - 30 Watt iron w/ST3 Tip Price \$43.28
WP35 - 35 Watt iron w/ST3 Tip Price \$50.44

ST Series Tips for W25, WP30, WP35 Irons



Part No.	Description	Tip Size "/mm	Reach "/mm	Price
ST1	Screwdriver Tip	0.06/1.58	0.75/19.05	\$6.20
ST2	Screwdriver Tip	0.09/2.38	0.75/19.05	6.20
ST3	Screwdriver Tip	0.12/3.17	0.75/19.05	6.20
ST4	Screwdriver Tip	0.18/4.74	0.75/19.05	6.20



Part No.	Description	Tip Size "/mm	Reach "/mm	Price
ST5	Single Flat Tip	0.03/0.79	0.75/19.05	\$6.20
ST6	Screwdriver Tip	0.03/0.79	0.75/19.05	6.20
ST7	Conical tip	0.03/0.79	0.75/19.05	6.20
ST8	Narrow SD Tip	0.06/1.58	0.75/19.05	6.20

WM120 Pencil Thin Soldering Iron

Lightweight, pencil thin soldering iron
Designed for soldering sensitive components where precision touch is essential
Develops tip temperature of 800°F



WM120 Price \$46.06

MP Series Tips for WM120 Iron

Part No.	Description	Tip Size "/mm	Reach "/mm	Price
MP131	Conical Tip	0.01/0.39	0.43/11.09	\$6.82
MP133	Single Flat 40° Tip	0.03/0.79	0.43/11.09	6.82
MP136	Narrow Screwdriver Tip	0.06/1.58	0.43/11.09	6.82

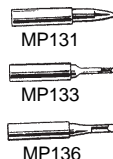

SP120, SP175 Marksman Series Soldering Irons

Stainless steel barrel develops 900°F Includes soldering iron rest
Heavy duty iron for greater output UL Listed
Ideal for home work-shop, repairs and hobbies



SP 120 W/MTG30 1/2" tip, 120V, 120W, 50/60 Hz Price \$56.78
SP 175 w/MTG40 5/8" tip, 120V, 175W, 50/60 Hz Price \$69.16

MTG Series Tips for SP120 & SP175 Iron

Part No.	Description	Tip Size "/mm	Reach "/mm	Price
MTG30	SP120 Chisel Tip	0.50/12.70	1.50/38.10	\$11.46
MTG40	SP175 Chisel Tip	0.62/15.87	2.50/63.50	19.48

9900 AS Anti-Static Electronic Soldering System

This premium, ESD-safe, modular system meets the full range of electronic soldering applications by means of four 24V-AC quick-connect micro and macro soldering irons.

Electronically controlled, variable temperature.
System meets military specifications: DOD-STD-2000- 1B, WS-6536E and MIL-S-45734E.
Temperature range 450°F to 850°F.
Dimensions 3.33"H x 3.80" W x 7.00"D weight 3 lbs.
120V-AC, 6 Hz., 3-wire grounded. UL Listed.
Two year limited warranty on power base.
Temperature variation less than $\pm 10^\circ\text{F}$.

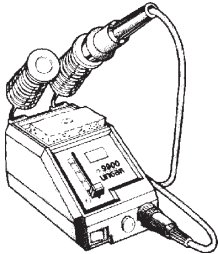

Weller Model 9910 AS System - Net Each \$169.80 Use with 9911 AS Micro Soldering Iron - Net Each \$123.04
Weller Model 9930 AS System - Net Each \$258.12 Use with 9931 AS Macro Soldering Iron - Net Each \$89.16
Weller Model 9900 AS Power Base Only - Net Each \$169.88

9900 AS Soldering Iron Selection

9911 AS for delicate electronic work

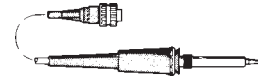

9931 AS For heavy ground planes - highest thermal capacity

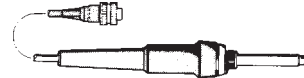

UTC 100/200/300/SYSTEMS

Economical ESD-safe soldering system features electronic closed-loop temperature control over a range of 400°F to 800°F. CMOS-safe unit meets military specifications MIL-STD-2000 1B, WS-6536E and MIL-S-45743E. UTC100 equipped with macro iron for general electronics work, UTC200 with micro iron for delicate soldering and UTC 300 high capacity system for the production environment. Dimensions 8.75" H x 4.0"W x 6.5"D., weight 1 lb., 120V-AC, 60 Hz., 3 wire grounded, U.L. Listed. One year warranty on power base.

Weller Model UTC100 Soldering System/Macro Iron - Net Each \$107.43
Weller Model UTC200 Soldering System/Micro Iron - Net Each \$121.62
Weller Model UTC300 Soldering System/ High Capacity \$128.46

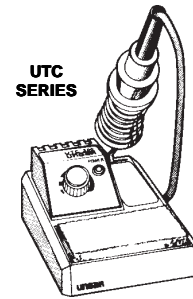

Replacement Parts, UTC100/200/300 Systems

Weller Model 455 Sponge- Net Each \$2.98
Weller Model UTC131 Macro Iron for UTC100 - Net Each \$107.43

HEAT GUNS

Model 1095

The Weller heat guns provide flameless heat for applying heat shrink tubing, curing epoxy, loosening adhesives, heating liquids, thawing frozen pipes, stripping paint and many other applications.

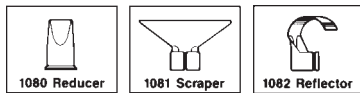
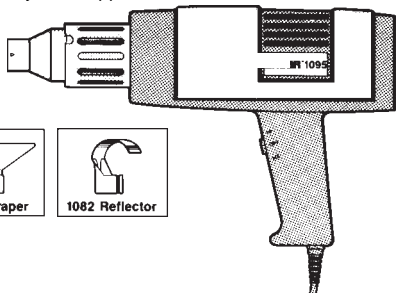

Rugged design and high and low temperature settings make this heat gun ideal for use in the laboratory, production line, repair shop or home. 1000 watts (Maximum), 120V-AC, 60Hz., 3-Wire grounded, 790°F -low, 1200°F high U.L. Listed.
Net Each \$47.22

Weller Model 1080 Reducer for Concentrating Heat - Net Each \$7.56
Weller Model 1081 Scraper for paint stripping - Net Each \$5.43
Weller Model 1082 Reflector for Heat Shrink - Net Each \$5.43

Model 6966C

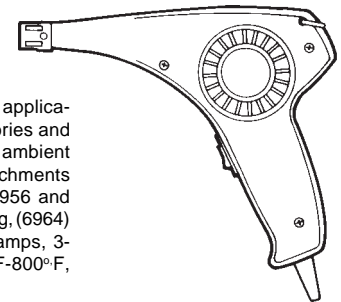

Designed for assembly and repair applications in production plants, laboratories and service shops. Delivers heated or ambient air. Comes complete with four attachments for applying heat shrink tubing (6956 and 6957) concentrating, (6958) focusing, (6964) heated air. 120V-AC, 60Hz., 2.2 amps, 3-wire grounded plug, 6' cord, 750°F-800°F, Weighs only 13 oz. U.L. Listed
Net Each \$162.50

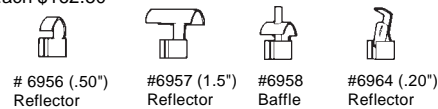

6966C Accessories

Weller Model 6956 1/2" Large Reflector - Net Each \$2.02
Weller Model 6957 1-1/2" Large Reflector - Net Each \$2.12
Weller Model 6958 Reducing Baffle - Net Each \$3.75
Weller Model 6964 Reflector - Net Each \$7.41
Weller Model 6965A Heat Gun Stand (not Shown) - Net Each \$17.21

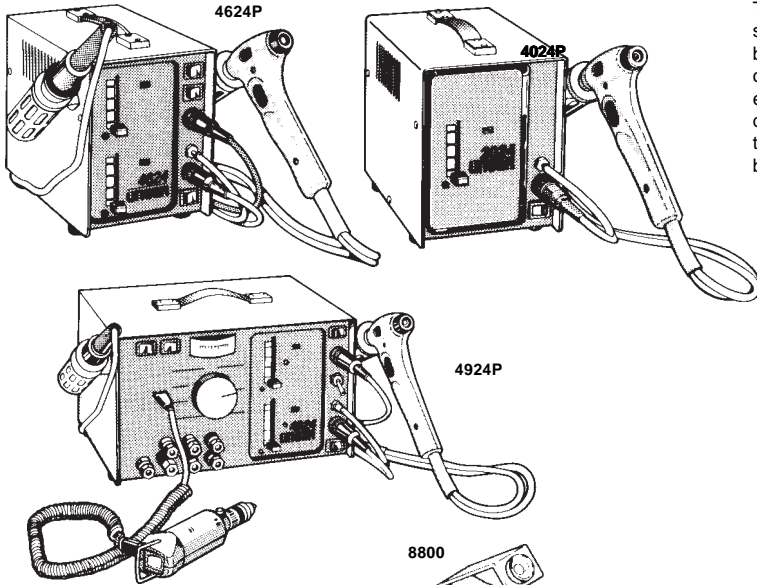

DESOLDERING IRON SELECTION

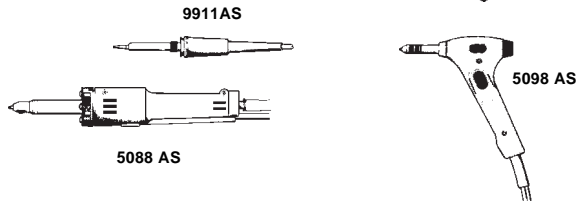

5098 AS High Output Desoldering Pistol - Comfortable, cool-to-grip handpiece with quick pop-out solder collection chamber for easy cleaning. Iron plated high-mass tiptets provide excellent thermal capacity for all jobs including multi-layered boards and heavy ground planes. ESD-Safe, provided with #4006 tiptet.
Net Each \$188.48

5088 AS High Output Desoldering Iron (Inline Style) - High thermal capacity design for tough jobs, such as thick multi-layer boards and heavy ground planes. Short tip to grip for greater control. ESD - safe, provided with #4006 tiptet.
Net Each \$188.48

Optional Accessories

Weller Model 8800 Free-standing Holder - Net Each \$36.98
Weller Model 2002 Desoldering Tip Cleaning Tool - Net Each \$16.88

5088 AS Replacement Parts

Weller Model 4080 Heater Assembly - Net Each \$95.96
Weller Model 4082 Heater Assembly - Net Each \$23.24

5098 AS Replacement Parts

Weller Model 2035 Glass Solder Chamber - Net Each \$22.68
Weller Model 2039 Handle Filter - (10 Pack) - Net Each \$5.00
Weller model 2042 Solder Delivery Tube - Net Each \$10.40
Weller Model 4351 Heater Assembly - Net Each \$105.72

The 4000 Series (Models ,4024,4624 and 4924) are compact, ESD-safe stations with multiple functions for the rework and repair of printed circuit boards. All the units can power 24V-AC desoldering irons and either micro or macro soldering irons. A built-in delay circuit maintains vacuum just long enough to minimize the chance of desolder tool clogging. The 4924 also operates a machine center motor as standard equipment. Variable temperature settings are controlled electronically by a closed loop feed back system that provides rapid heat up and quick response to loads.

Soldering mode meets military specifications; MIL-STD-2001B, WS6536E and MIL-S-45743E.

Temperature range: Desoldering: 500°F to 1000°F ; Soldering: 450°F to 850°F

120V-AC, 60Hz., 3- wire grounded.

UL Listed

One year limited warranty on tools and bases.

Model 4024P - Powered with shop air and equipped with 5098AS desoldering pistol. The unit may also operate optional soldering irons in place of the desoldering iron. Pistol comes with tiptet #4006 and #4007. Model 4024II same as 4024P except 5088AS Inline style desoldering iron.
Net Each \$566.63

Model 4624P - Self contained vacuum system operates soldering iron and desoldering iron concurrently or two soldering irons. Equipped with 5098 AS desoldering pistol and 9931 AS macro-size soldering iron. Pistol comes with tiptets #4006 and #4007. Model 4624L same as 4624P except 5088AS Inline style desoldering iron.
Net each \$740.67

Model 4924P - Complete service center for virtually all rework applications. Powers soldering iron and desoldering iron or two soldering iron concurrently and has an added power supply for optional tools such as thermal wire strippers and resistance soldering tweezers. Vacuum may be switched to positive air flow for heat gun applications. Center is equipped with 5098 AS desoldering iron, 9931 AS macro-size soldering iron, 9911 AS micro-size soldering iron, machine center motor for milling, drilling and grinding, and 8800 deluxe iron holder.
Net each \$1524.56

DESOLDERING TIPS

Tips for Weller 5098AS and 5088AS desoldering pistol.

2000Series tips are for 4098AS series tools only.

Model No.	Outside Dia.	Inside Dia.	Unit Price
4005	.060	.040	\$15.60
4006	.080	.050	15.60
4007	.100	.070	15.60
4008	.120	.090	15.60

Model No.	Outside Dia.	Inside Dia.	Unit Price
2005	.060	.032	\$11.12
2006	.080	.040	11.12
2007	.100	.062	11.12
2008	.120	.089	11.12
2009	.100	.062	11.12
2010	.060	.032	11.12
2011	.080	.040	11.12
2012	.040	.020	11.12

Tips for Weller 5088AS Desoldering pencil.

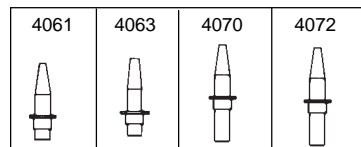

Model No.	Outside Dia.	Inside Dia.	Length	Unit Price
4061	.060	.025	1 inch	\$3.45
4070	.052	.018	2 inch	4.32
4072	.080	.035	2 inch	4.32
4073	.090	.050	2 inch	4.32

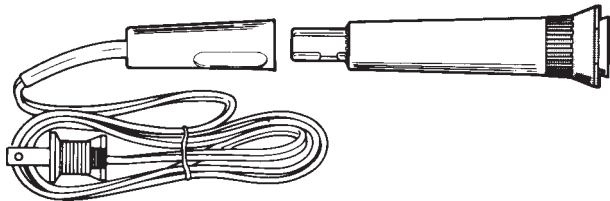

IMPERIAL HEAVY DUTY SOLDERING IRON

Ideal for continuous production line work on larger connections, sub-assemblies and system applications. Combine modular components for a tailor made soldering iron. Exclusive, patented heat sink design keeps handle comfortable during extended operation. U.L. Listed

CORD SETS

Flexible vinyl with molded connector plug. U.L. Listed 2 wire or 3- wire.

Weller Model 6102 2 wire - Net Each \$21.96

Weller Model 6103 3 wire grounded - Net Each \$22.10

PERMA-COOL HANDLE

Length - 4.7", diameter at grip - 0.8". Turquoise colored. 120V AC.

Weller Model 6100 Perma-Cool Handle - Net Each \$10.08



HEAT CARTRIDGE

Temperature resistant stainless steel body and copper alloy heat collector designed to provide maximum heat transfer. Cartridges can be easily changed at the work station.

Weller Model 6202 25W 600-800°F - Net Each \$26.67

Weller Model 6201 35W 650-850°F - Net Each \$26.67

Weller Model 6200 45W 750-950°F - Net Each \$26.67

Weller Model 6203 55W 850-1150°F - Net Each \$421.58

IMPERIAL SOLDERING IRON KIT

Features most popular components used in production, R & D and repair service. Includes 6100 handle, 6102 2-wire cord set, 6200 45W heat cartridge and three thread-on soldering tips. Delivers 750°F to 905°F tip temperature.

Weller Model 6010 Soldering Iron Kit - Net Each \$61.97

For Imperial Tip Selection see page 543.

DOUBLE INSULATED (DI) SOLDERING IRON

Lightweight, compact modular design consists of double insulated handle and selection of heating elements. Every handle and heating element is tested to U.L. Specifications for double insulation U.L. Listed



HANDLE

Cool, "soft-touch" grip with flexible 2 - wire cord

Weller Model 5550 Double Insulated Handle - Net Each \$16.31

DI HEATING ELEMENTS

Weller Model 360 27W 650-750°F - Net Each \$21.59

Weller Model 361 35W 750-850°F - Net Each \$21.59

For 1/4" Thread-On tip selection see page 543.

PRODUCTION AIDS

Scrub-It Solvent Dispenser

The dispenser is squeezed to distribute solvent through a brush for cleaning printed circuit boards and other solder connections. No mess, no waste. Available with nylon bristles or horsehair for static-safe applications.

SD74 with nylon bristles.

Net Each \$10.64

SD74H ESD safe with horsehair bristles.

Net Each \$10.64



SM1 Solder-Mate

This durable dispenser minimizes cord solder usage. It also eliminates operator downtime by providing continuous solder wire availability. Holds a 1 pound solder spool.

Net Each \$15.59



Flux Dispensers

Both static-safe and standard 2 oz. flux dispensers avoid spills and waste and place flux precisely where it is needed. The squeeze bottles dispense one drop of liquid resin, flux, oil or solvent through stainless steel needles. Static dissipative models protect static-sensitive components.



Standard

Static Dissipative

Standard Flux Dispenser

FD2 with .5" x .020" needle

Net Each \$2.25

FD21 with .5" x .010" needle

Net Each \$2.25

FD22 with .5 x .054" needle

Net Each \$2.25

FD3 with all three of above needles

Net Each \$2.25

Static Dissipative Flux Dispensers

FD2D with 1" x .023" needle

Net Each \$2.87

FD21D with 1" x .010" needle

Net Each \$2.87

FD22D with 1" x .054" needle

Net Each \$2.87

Spot-Mask Peelable Latex Soldering Mask

This thick, latex-type material masks PCB holes and other surfaces requiring protection. It won't run, and it withstands soldering and cleaning environments. The ten mil coating dries in two to three hours at ambient temperature and peels clean. A filtered formula is available for automatic dispensing equipment with .010" needle I.D. minimum. Shelf Life: one year.

SM1573-1 Standard 1 gal.

Net Each \$64.47

SM1573-8 Standard 8 oz.

Net Each \$5.42

SM1574-1 Filtered 1 gal.

Net Each \$67.23

SM1574-8 Filtered 8oz.

Net Each \$5.78

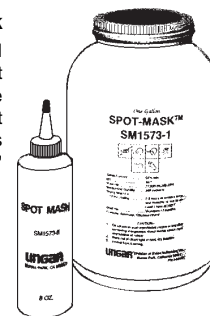

COMPLETE IRONS FOR ELECTRONICS WORK

These ready-to-use professional soldering irons feature interchangeable handles, heaters and tips for custom applications and easy maintenance. Handles are 3-wire grounded with cool, "soft touch" acid and flux resistant grips. U.L. listed

Weller Model SL325 25 Watts, 700°F - Net Each \$29.91
Weller Model SL335 35 Watts, 800°F - Net Each \$31.77
Weller Model SL345 45 Watts, 900°F - Net Each \$33.66

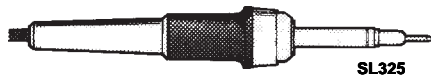

SL325



SL335



SL345

STANDARD LINE SOLDERING HANDLES AND HEATERS

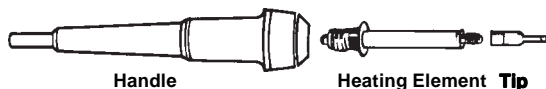

Handle

Heating Element Tip

Ideal for soldering electronic devices, printed circuit boards and heavy wiring. Custom design the exact soldering iron to meet your application by choosing heaters and interchangeable tips. All handles and heaters are interchangeable with the SL series of complete soldering irons shown above.

SOLDERING IRON HANDLES

Durable, balanced handles all feature cool, "soft touch" acid and flux resistant grips and accept the full range of Weller heaters and integral heater tips.

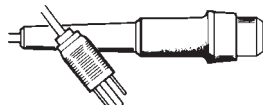

7500
3-wire grounded, burn resistant cord and spring loaded, heat reflective ground plate.

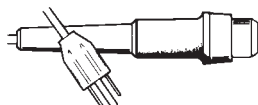

7400
Same as 7500 except with standard 3-wire cord. Replacement handle for SL325, SL335 and SL345.

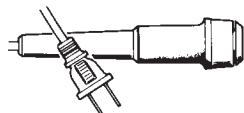

7770
All purpose, economical 2-wire blue handle.

Weller Model 7500 3-wire, burn resistant cord - Net Each \$26.34
Weller Model 7400 3-wire, standard cord - Net Each \$18.20
Weller Model 7770 2-wire, blue - Net Each \$12.71
Weller Model 7760 2-wire, red - Net Each \$12.71

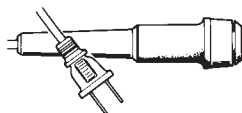

7760
Same as 7770, except red in color

INTERCHANGEABLE HEATING ELEMENTS

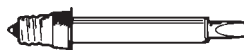

Integral Heater/Tips

Integral Heater/Tip
Typical length - 3.78", dia. - .364"

Weller Model 533S Long taper chisel 23W, 800°F, copper - Net Each \$15.44
Weller Model 1233S Long taper chisel 33W, 900°F, copper - Net Each \$25.70
Weller Model 4033S Long taper chisel 45W, 1000°F, iron clad - Net Each \$24.47
Weller Model 33 Long taper chisel 50W, 1100°F, iron clad, Net Each \$31.25



Heater for 1/4" Thread-on Tips
Typical length - 3.43", dia. - .364"

Heater for 1/4" Thread-on Tips
Weller Model 537S 23W, 700°F - Net Each \$15.59
Weller Model 1237S 33W, 800°F - Net Each \$17.00
Weller Model 4037S 45W, 900°F - Net Each \$17.83
Weller Model 37 50W, 1000°F - Net Each \$38.00



Heater for 1/8" Thread-in Tips
Typical length - 3.55", dia. - .364"

Heater for 1/8" Thread-in Tips
Weller Model 535S 23W, 700°F - Net Each \$17.49
Weller Model 1235S 33W, 800°F - Net Each \$17.10
Weller Model 4035S 45W, 900°F - Net Each \$19.56

See page 543 for tip selection for thread-in and thread-on heaters.



SOLDERING TIPS

1/4" Thread-on tips for use with SL series, 3125,3140,UTC100, DI and standard line heaters

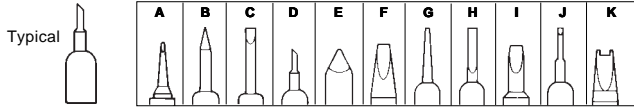

Fig	Model No.	Description	Point	Unit Price
A	PL100	Precision electronic	.05	\$4.44
B	PL111	Pencil	.03	4.65
B	111*		.02	2.46
C	PL113	Chisel	.13	4.65
C	113*		.12	2.46
D	PL114	Micro Spade	.05	4.65
E	PL116	Pyramid		7.34
E	116*			3.39
F	PL133	Long Taper Chisel	.15	5.28
G	PL138	Tapered Needle	.05	4.73
H	PL151	Screwdriver	.13	4.73
I	PL153	Chisel	.20	5.69
J	PL155	Stepped Chisel	.07	4.73
K	PL400	Fork	.19	7.02

* Copper

Tips for 3800,9200,9921 and Wellermatic.

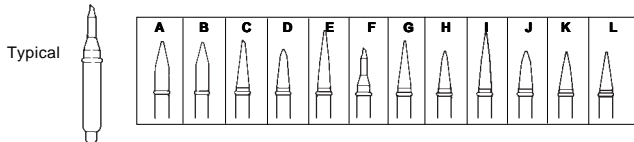

Fig	Model No.	Description	Point	Unit Price
B	81	Screwdriver	.23	\$7.11
C	82	Spade	.03	8.11
D	83	Screwdriver	.09	7.11
E	84	Long Screwdriver	.08	7.11
F	85	Stepped Spade	.05	7.11
G	86BK	Needle	.05	6.81
H	87	Screwdriver	.06	7.11
I	88BK	Long Screwdriver	.05	6.80
J	92BK	Screwdriver	.13	6.80
K	93BK	Screwdriver	.03	6.80
L	94BK	Short Conical	.03	6.80

Tips for Imperial Heaters Only.

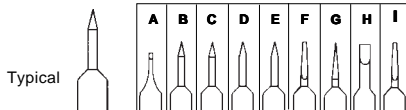

Fig	Model No.	Description	Point	Unit Price
A	6304	Micro Chisel	.05 x .01	\$6.50
B	6312*	Pencil	.01 Dia.	3.11
C	6313	Pencil	.02 Dia.	9.22
D	6318	Long Taper Chisel	.12 x .01	3.11
E	6319	Long Taper Chisel	.13 x .02	9.22
G	6333	X-Long Taper Chisel	.015 Dia	8.06
H	6366	Long Taper Chisel	.20 x .02	10.28
I	6481	Taper Screwdriver	.13 x .02	6.50

* Copper

Tips for 9000,9001,9300,9911 and UTC200

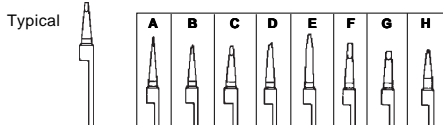

Fig	Model No.	Description	Point	Unit Price
A	9010	Precision Point	.01 Dia.	\$8.46
B	9011	Spade	.03 x 60°	7.31
C	9012	Screwdriver	.05	7.31
D	9013	Spade	.06 x 45°	7.31
E	9014	Spade	.02 x 60°	7.31
F	9015	Screwdriver	.07	7.31
G	9016	Screwdriver	.09	6.80
H	9017	Screwdriver	.03	8.11

1/8" Threaded-in Tips for use with standard line " UTC100" and Princess Heaters.

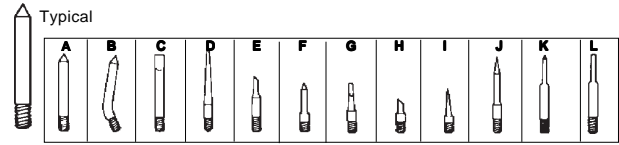

Fig	Model No.	Description	Point	Unit Price
	100	Adapter		\$2.45
A	PL331	(Not Shown)	Cone	3.72
B	PL332	Offset Pencil	Cone	3.72
C	PL333	Chisel	.13	3.72
C	333*		.12	2.09
D	PL338	Tapered Needle	.05	3.72
E	PL340		.06	3.72
G	6951*	Pencil	.06	2.25
G	6961	Screwdriver		4.32
I	6953*	Precision Point	Cone	3.90
I	6963			7.11
K	7154	Pencil	Cone	4.59
L	7155	Chisel	.06	4.59

* Copper

For use with heaters #535S, # 1235S,#4035S
With # 100 Adapter may be used with #537S, # 1237S, #4037S and # 37.
With #9054 Adapter may be used with 9300 iron, 9911, 9000 and 9100

Tips for 9931,9941, and UTC 300

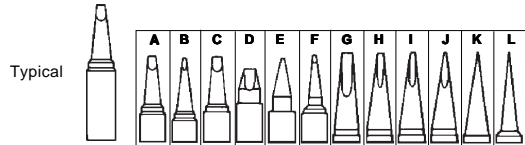

Fig	Model No.	Description	Point	Unit Price
A	9960*	Terminal Spade	.10 X .03	\$7.31
B	9961*	Pad Spade	.07 X .03	3.46
C	9962*	Bus Spade	.13 X .045	3.46
D	9963*	Heavy Spade	.19 X .05	3.46
E	9964*	Heavy Probe	.03 Dia.	3.46
F	9965*	Stub Spade	.06 x .02	3.46
G	9966*	Long Screwdriver Heavy Duty	.13 x .04	3.46
H	9967*	Long Screwdriver Medium Duty	.07 x .03	4.04
I	9968*	Long Screwdriver Medium Duty	.05 x .03	4.04
J	9969*	Long Screwdriver	.03 x .015	2.90
K	9970	Precision Point Heavy Duty	.01 Dia.	8.46
L	9971	Precision Point Medium Duty	.01 Dia	8.46

* Not recommended for 9941 iron.

Tips for 9931 and UTC 300

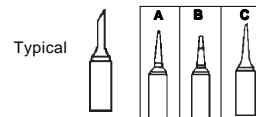
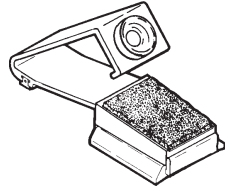

Fig	Model No.	Description	Point	Unit Price
A	9976	Spade	.03 x 60°	\$9.31
B	9977	Screwdriver	.05 x .015	7.31
C	9986	Stub Spade	.04 x 60°	8.46

ACCESSORIES FOR SOLDERING / DESOLDERING

8800 SOLDERING IRON HOLDER

Designed to hold all Weller soldering and desoldering irons. Sturdy, non-skid design with cool ceramic mouthpiece. Sponge included.
Net Each \$27.81



9800 SOLDERING IRON HOLDER

Same as Weller universal, ceramic mouthpiece. Sponge included
Net Each \$20.75

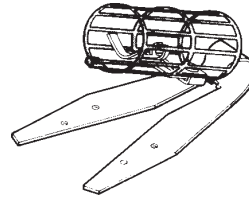
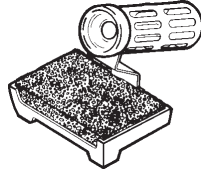

MODEL 8000 SOLDERING IRON HOLDER

Protects operator from burns: prevents iron breakage. Use with Weller Standard Line, Imperial Line, 3-Wire Line and DI Line. Attaches easily to bench; angle adjustable.
Weller Model 8000 Net Each \$13.60

KLEEN-TIP SPONGE AND TRAY

Specially processed sponge provides the surest way to clean soldering tips. Removes oxidation, prevents contamination and insures soldering reliability.
Weller Model 400 - Net Each \$6.95

7874B DESOLDERING PUMP

One hand operation with spring-loaded piston provides ESD-safe vacuum that removes solder. Self-cleaning, non-clogging, static-free replaceable tip
Weller Model 7874B Desoldering Pump - Net Each \$17.42
Weller Model 7875B Replacement Tip - Net Each \$3.71



WELLER SOLDER-OFF BULB

Desoldering bulb with TFE tip facilitates accurate printed circuit repair and cleaning. May be used with soldering iron. (Not Illustrated)
Weller Model 7805 Solder-Off Bulb - Net Each \$10.16

DIP EXTRACTION PLIERS

Spring loaded extraction pliers remove 4-48 pin DIP's without bending leads Self-activating; one hand operation.
Weller Model 6980 DIP Extraction Pliers - Net Each \$42.21

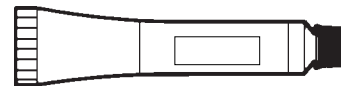
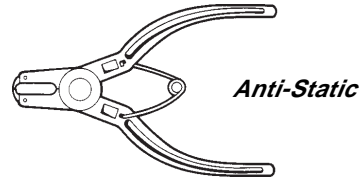

ANTI-SEIZE

Specially formulated lubricant for use on metals operating at high temperatures. Reduces tip thread seizure and prolongs tip life.
Weller Model 8001 1/2 oz. tube - Net Each \$4.34

TEMPERATURE CONTROLLED SOLDERING STATIONS

EC2002/EC1002

- LED readout displays temperature settings and tip temperature with a resolution and stability of 1°F (1°C)
- Instantaneous tip temperature readings with "read" switch position
- Handles the most delicate of applications
- Electrostatic dissipative (ESD safe), UL listed
- Available with 40, 20 or 42 watt iron, stand, with tip storage, positions left, right or remotely of main unit
- Water reservoir keeps sponge moist
- SPEC. COMPLIANCE: DOD-STD-2000, Mil-S-2000, Mil-S-45743, W-S-6536, W-S-570 and DOD-STD 1686

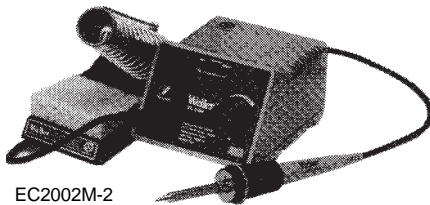

EC2002M-2

Part No.	Description	Price
EC2002M-1	Complete station w/EC1201A 40w iron, ETA tip & stand	\$361.05
EC2002M-2	Complete station w/EC1302A 20w iron, EPH101 tip & stand	361.05
EC2002M-3	Complete station w/EC1503A 42w iron EMA tip & stand	377.76

Model 1002 is identical to Model 2002, except that it does not have the LED display

Part No.	Description	Price
EC1002-1	Complete station w/EC1201A 40w iron, ETA tip & stand	\$263.73
EC1002-2	Complete station w/EC1302A 20w iron, EPH101 tip & stand	263.73
EC1002-3	Complete station w/EC1503A 42w iron EMA tip & stand	280.41

ET Series Tips for EC1201A Irons

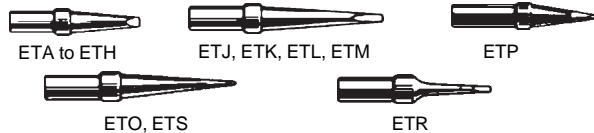

Part No.	Description	Tip Size "/mm	Reach "/mm	Price
ETA	Screwdriver Tip	0.06/1.60	0.62/15.90	\$5.83
ETB	Screwdriver Tip	0.09/2.40	0.62/15.90	5.83
ETC	Screwdriver Tip	0.12/3.20	0.62/15.90	5.83
ETD	Screwdriver Tip	0.18/0.48	0.62/15.90	5.83
ETH	Screwdriver Tip	0.03/0.80	0.62/15.90	5.83
ETP	Conical Tip	0.03/0.80	0.62/15.90	5.83
ETO	Long Conical Tip	0.03/0.80	1.00/25.40	5.83
ETS	Long Conical Tip	0.01/0.40	1.00/25.40	5.83
ETJ	Long Screwdriver	0.03/0.08	1.00/25.40	5.83
ETK	Long Screwdriver	0.04/1.20	1.00/25.40	5.83
ETL	Long Screwdriver	0.07/2.00	1.00/25.40	5.83
ETM	Long Screwdriver	0.12/3.20	1.00/25.40	5.83
ETR	Narrow Screwdriver	0.06/1.60	0.62/15.90	5.83

EPH Series Tips for EC1302A Irons

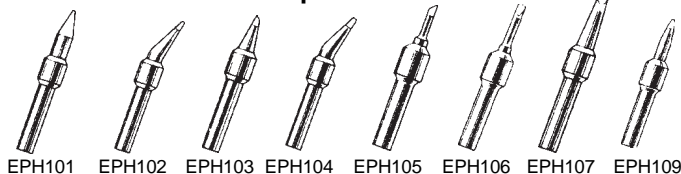

Part No.	Description	Tip Size "/mm	Reach "/mm	Price
EPH101	Micropoint Tip	0.01/0.40	0.43/11.10	\$6.11
EPH102	Bent Conical Tip	0.03/0.80	0.43/11.10	6.11
EPH103	Single Flat Tip	0.03/0.80	0.31/7.90	6.11
EPH104	Bent Conical Tip	0.04/1.20	0.43/11.10	6.11
EPH105	Single Flat Tip	0.04/1.20	0.31/7.90	6.11
EPH106	Screwdriver Tip	0.06/1.60	0.43/11.10	6.11
EPH107	Chisel Tip	0.07/2.00	0.43/11.10	6.11
EPH109	Conical Tip	0.03/0.80	0.43/11.10	6.11

EM Series Tips for EC1503A Iron

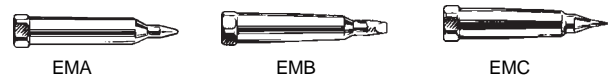

Part No.	Description	Tip Size "/mm	Reach "/mm	Price
EMA	Chisel Tip	0.06/1.60	0.42/10.66	\$13.88
EMB	Chisel Tip	0.09/2.36	0.42/10.66	13.88
EMC	Conical Tip	0.01/0.35	0.42/10.66	13.88

WTL1000 THERMALOCK SYSTEM

- Tip temperature controlled by Thermolock® "keys"
-PROVIDES OPERATOR LOCKOUT-
- Tip temperature automatically set to within ± 10°F with insertion of different Thermolock® "key"
- Safety feature powers iron down to 350°F if "key" is removed while unit is on
- Electrostatic dissipative (ESD safe), UL-Listed
- For use with 40, 20 and 42 watt irons
- Iron stand, with tip storage, positions left, right or remotely of main unit
- SPEC. COMPLIANCE: DOD-STD-2000, MIL-S-2000, Mil-S-45743, W-S-6536, W-S-570 and DOD-STD-1686

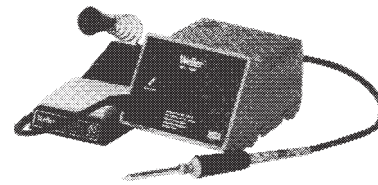

WTL1000-2

Part No.	Description	Price
WTL1000-1	Complete station w/EC1201A 40w iron, ETA tip & stand	\$162.11
WTL1000-2	Complete station w/EC1302A 20w iron, EPH101 tip & stand	265.76
WTL1000-3	Complete station w/EC1503A 42w iron EMA tip & stand	282.65

TEMPERATURE KEYS

Part No.	Color Code	Temp (°F)	For Tip Style	Price
TL600A	White	600	ETA	\$22.68
TL700A	White	700	EPH101	22.68
TL800A	White	800	EMA	22.68

DEC1001 DUAL SOLDER STATION

- Combined power of two temperature controlled stations in one
- Dual dial temperature range of 350°F to 850°F
- Ideal for multiple use situations - Power unit output: 24 VAC
- For use with 40, 20 or 42 watt irons combining any two at a time
IRONS SOLD SEPARATELY
- Electrostatic dissipative (ESD safe), UL-Listed
- Two iron stands included with tip storage, positions left, right or remotely
- SPEC. COMPLIANCE: DOD-STD-2000, Mil-S-2000, Mil-S-4574 W-S-6536, W-S-570 and DOD-STD-1686

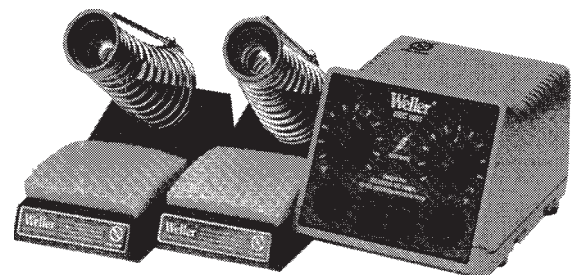

DEC1001

Part No.	Description	Price
DEC1001*	Dual iron power unit w/two iron stands	\$263.45

*Irons sold separately

IRONS FOR EC SOLDERING STATIONS

- Specifically designed for use at electrostatic free work stations
- Completely free from stored static charges (ESD safe)
- Features stainless steel plug-in heater element construction
- Non-burning silicon rubber cord

- Handle design is lightweight, high impact plastic
- Blue plastic meets Mil-B-18705 requirements for electrostatic protective materials
- Weller station and iron combination meets: DOD-STD-2000, Mil-S-2000, Mil-S-45743, W-S-570, DOD-STD-1686

WELLER EC1201A - General purpose soldering tool
40w soldering iron w/ETA tip Price \$102.45
WELLER EC1204A - 54w soldering iron w/ETA tip Price \$102.45

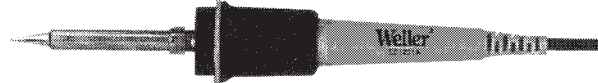

EC1201A

WELLER EC1302A - Micro soldering tool
20w soldering iron w/EPH101 tip Price \$119.13



EC1302A

WELLER EC1503A - Tool for difficult applications, such as multilayer boards
42w soldering iron w/EMA tip Price \$119.13
WELLER EC1504A - 54w soldering iron w/EMA tip Price \$119.13



EC1503A

WTCPT CONTROLLED-OUTPUT SOLDERING STATION

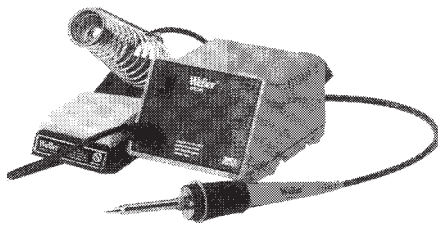

























- Transformer powered soldering station complete with lightweight, low voltage, temperature controlled soldering iron.
- Special "closed loop" method of controlling maximum tip temperature
- Power unit housing features impact resistant plastic for durability
- Quick disconnect plug for soldering iron and lighted on/off switch
- Station housing and iron are grounded with separate conductor that terminates at third pin of power cord
- PT series soldering tips come in a variety of shapes and sizes in three temperature ranges: 600°F, 700°F and 800°F

WTCPT complete soldering station - 24V output Price \$149.18

TC201T 42w soldering iron with PTA7 tip Price \$78.33

PT SERIES TIPS FOR TC201T IRON

					
PTA6 600°F PTA7 700°F PTA8 800°F	PTAA6 600°F PTAA7 700°F PTAA8 800°F	PTB6 600°F PTB7 700°F PTB8 800°F	PTBB6 600°F PTBB7 700°F PTBB8 800°F	PTC6 600°F PTC7 700°F PTC8 800°F	PTCC6 600°F PTCC7 700°F PTCC8 800°F
					
PTD6 600°F PTD7 700°F PTD8 800°F	PTDD6 600°F PTDD7 700°F PTDD8 800°F	PTE6 600°F PTE7 700°F PTE8 800°F	PTF6 600°F PTF7 700°F PTF8 800°F	PTH6 600°F PTH7 700°F PTH8 800°F	PTJ6 600°F PTJ7 700°F PTJ8 800°F
					
PTK6 600°F PTK7 700°F PTK8 800°F	PTL6 600°F PTL7 700°F PTL8 800°F	PTM6 600°F PTM7 700°F PTM8 800°F	PTN6 600°F PTN7 700°F PTN8 800°F	PTO6 600°F PTO7 700°F PTO8 800°F	PTP6 600°F PTP7 700°F PTP8 800°F
					
PTQ6 600°F PTQ7 700°F PTQ8 800°F	PTR6 600°F PTR7 700°F PTR8 800°F	PTS6 600°F PTS7 700°F PTS8 800°F	PTT6 600°F PTT7 700°F PTT8 800°F	PTX6 600°F PTX7 700°F PTX8 800°F	PTZ6 600°F PTZ7 700°F PTZ8 800°F

All PT Series Tips are priced at \$6.18 ea.

PROFESSIONAL SOLDERING IRONS

W60P Series Irons

Line Voltage high quality portable tool
Controlled output and temperature
Iron features stainless steel modular plug-in heater construction
Nominal heat-up time w/CT5E7 tip = 110 seconds
Comes with CT5A7, 700°F 1/16" dia. screwdriver tip
Available with 3-wire cord as W60P-3

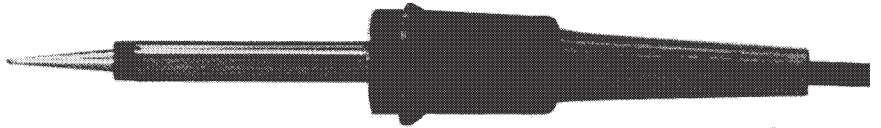

60P - 60 Watt iron w/CT5A7 Tip Price \$67.91
W60P-3 - Same with 3-wire cord Price \$73.78

W100PG Series Irons

Line Voltage high quality portable tool
Controlled output and temperature
Iron features stainless steel modular plug-in heater construction
Nominal heat-up time w/CT6F7 tip = 110 seconds
Comes with CT6F7, 700°F 1/4" dia. screwdriver tip
Available with 3-wire cord as W100P-3

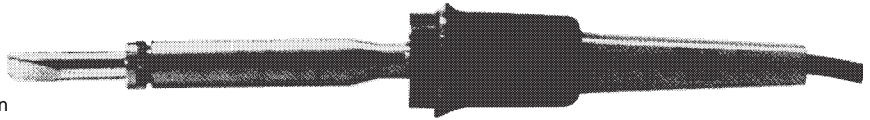

W100PG - 100 Watt iron w/CT6F7 Tip Price \$65.70
W100P-3 - Same with 3-wire cord Price \$79.55

CT Series Tips for W60P and W100PG Irons

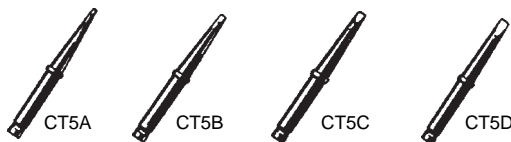

Part No.	Description	Temp °F	Tip Size "/mm	Reach "/mm	Price
CT5A7	W60P Screwdriver Tip	700	0.06/1.58	1.15/29.36	\$6.93
CT5A8	W60P Screwdriver Tip	800	0.06/1.58	1.15/29.36	6.93
CT5B7	W60P Screwdriver Tip	700	0.09/2.38	1.15/29.36	6.93
CT5B8	W60P Screwdriver Tip	800	0.09/2.38	1.15/29.36	6.93
CT5C6	W60P Screwdriver Tip	600	0.12/3.17	1.15/29.36	6.93
CT5C7	W60P Screwdriver Tip	700	0.12/3.17	1.15/29.36	6.93
CT5C8	W60P Screwdriver Tip	800	0.12/3.17	1.15/29.36	6.93
CT5D7	W60P Screwdriver Tip	700	0.18/4.74	1.15/29.36	6.93
CT5D8	W60P Screwdriver Tip	800	0.18/4.74	1.15/29.36	6.93

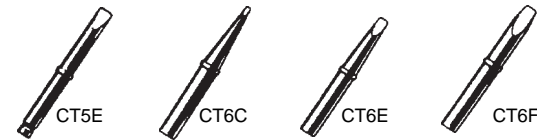

Part No.	Description	Temp °F	Tip Size "/mm	Reach "/mm	Price
CT5E6	W60P Screwdriver Tip	600	0.25/6.35	1.15/29.36	\$6.93
CT5E7	W60P Screwdriver Tip	700	0.25/6.35	1.15/29.36	6.93
CT5E8	W60P Screwdriver Tip	800	0.25/6.35	1.15/29.36	6.93
CT6C7	W100PG Screwdriver Tip	700	0.12/3.17	1.37/34.92	9.91
CT6E7	W100PG Screwdriver Tip	700	0.25/6.35	1.37/34.92	9.91
CT6E8	W100PG Screwdriver Tip	800	0.25/6.35	1.37/34.92	9.91
CT6F8	W100PG Screwdriver Tip	800	0.37/9.52	1.37/34.92	9.91

WP25, WP30, WP35 Series Irons

Ideal for a wide variety of electronic tasks
Interchangeable heater elements
Quick change knurled collar makes changing heater simple
Small lightweight handle with cushioned grip
3-Wire power cord for additional safety



WP25 - 25 Watt iron w/ET3 Tip Price \$40.08
WP30 - 30 Watt iron w/ST3 Tip Price \$43.28
WP35 - 35 Watt iron w/ST3 Tip Price \$50.44

ST Series Tips for W25, WP30, WP35 Irons



Part No.	Description	Tip Size "/mm	Reach "/mm	Price
ST1	Screwdriver Tip	0.06/1.58	0.75/19.05	\$5.48
ST2	Screwdriver Tip	0.09/2.38	0.75/19.05	5.48
ST3	Screwdriver Tip	0.12/3.17	0.75/19.05	5.48
ST4	Screwdriver Tip	0.18/4.74	0.75/19.05	5.48



Part No.	Description	Tip Size "/mm	Reach "/mm	Price
ST5	Single Flat Tip	0.03/0.79	0.75/19.05	\$6.58
ST6	Screwdriver Tip	0.03/0.79	0.75/19.05	6.58
ST7	Conical tip	0.03/0.79	0.75/19.05	6.58
ST8	Narrow SD Tip	0.06/1.58	0.75/19.05	6.58

WM120 Pencil Thin Soldering Iron

Lightweight, pencil thin soldering iron
Designed for soldering sensitive components where precision touch is essential
Develops tip temperature of 800°F



WM120 Price \$46.06

MP Series Tips for WM120 Iron

Part No.	Description	Tip Size "/mm	Reach "/mm	Price
MP131	Conical Tip	0.01/0.39	0.43/11.09	\$6.06
MP133	Single Flat 40° Tip	0.03/0.79	0.43/11.09	6.06
MP136	Narrow Screwdriver Tip	0.06/1.58	0.43/11.09	6.06

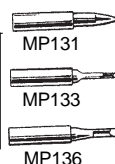

SP120, SP175 Marksman Series Soldering Irons

Stainless steel barrel develops 900°F
Heavy duty iron for greater output
Ideal for home work-shop, repairs and hobbies

Includes soldering iron rest
UL Listed



SP 120 W/MTG30 1/2" tip, 120V, 120W, 50/60 Hz Price \$49.81
SP 175 w/MTG40 5/8" tip, 120V, 175W, 50/60 Hz Price \$60.68

MTG Series Tips for SP120 & SP175 Iron

Part No.	Description	Tip Size "/mm	Reach "/mm	Price
MTG30	SP120 Chisel Tip	0.50/12.70	1.50/38.10	\$10.28
MTG40	SP175 Chisel Tip	0.62/15.87	2.50/63.50	17.56

Cordless Soldering Tools

WSTA3 Pyropen®

Lightweight/completely portable
Runs on LP gas for three hours of operation
Ready to solder in 30 seconds
Temperature control 392°F-932°F
14 Tip combinations available

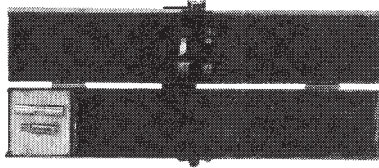

WSTA3 Pyropen Price \$117.16

WPA2 Self-Igniting Pyropen®

Lightweight/completely portable
Runs on LP gas for three hours of operation
Press self-igniting button and iron is ready to solder in 30 seconds....no need for matches
Temperature control 482°F-932°F
14 Tip combinations available
Inactive hot air nozzles for low temperature heat



WPA2 Self-igniting cordless soldering iron Price \$128.56
WPAB Pyropen burner Price \$22.25

WPT Series Tips for WSTA3 & WPA2 Pyropen® Irons



Part No.	Description	Price
WPT-2	2mm Chisel Tip	\$13.30
WPT-4	3mm 45° Spade Tip	13.30
WPT-5	Taper Needle Tip	13.30
WPT-11	8mm High Powered Chisel Tip	13.30

P1 Series Portasol® Cordless Soldering Tool



Adjustable temperature control, melts solder in less than 40 seconds
Up to 90 minute continuous use fuel capacity
Safety cut-off switch when cap is replaced
Patented catalytic converter that provides powerful safe flameless combustion
Fast, flint sparked ignition in cap

Kit contains 1 each:
Portasol iron
3/32" iron plated tip
Cleaning sponge
Blow torch
Hot Blower
Hot Knife

P1KB Cordless soldering iron, Kit-boxed Price \$63.66

T Series Tips for P-1 Portasol® Irons

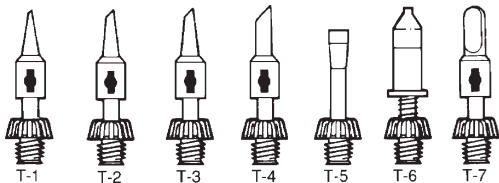

Part No.	Description	Tip Size "/mm	Reach "/mm	Price
T-1	Fine Point Soldering Tip	0.03/0.79	0.75/19.05	\$9.95
T-2	Spade Tip	0.09/2.38	0.75/19.05	9.95
T-3	Spade Tip	0.12/3.17	0.75/19.05	9.95
T-4	Spade Tip	0.18/4.74	0.75/19.75	9.95
T-5	Blow Torch Tip - Temp range up to 2372 °F			9.95
T-6	Hot Blower Tip - Temp range up to 850 °F			9.95
T-7	Hot Knife Tip - Temp range up to 850 °F			9.95

WST2 Pyropen® Jr.

Lightweight/portable.....carry it in your pocket.
Mini iron soldering everywhere with temperature control.
Dual function soldering iron and brazing torch.

WST2 Cordless soldering iron Price \$104.98

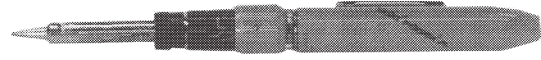

WPT Series Tips for WST2 Pyropen® Jr Irons

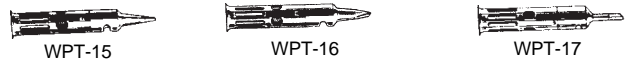

Part No.	Description	Price
WPT-15	0.5mm Tapered Needle Tip	\$15.96
WPT-16	3mm Chisel Point Tip	15.96
WPT-17	3mm Spade Point Tip	15.96

**Weller
Desoldering
Equipment**

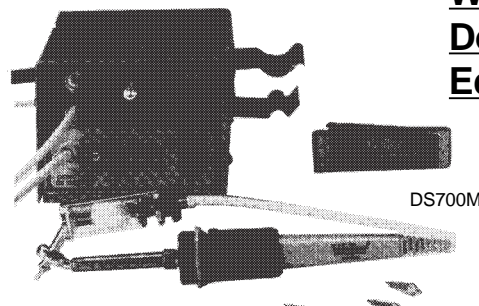

DS 700M Electronically Controlled Desoldering Station

Lightweight, compact electronic power de-soldering unit with internal vacuum pump.
Finger tip control of the desoldering vacuum.
Special large capacity air filter is provided in the power unit to back up the small filter in the solder-collection reservoir in the tool.
Air output is also available for low volume heat shrinking and other hot air jobs.
Lightweight with convenient index finger push button to control the vacuum.
ESD Safe - SPEC. Compliance DOD-STD-2000-1

DS700M Desoldering Station Price \$954.12

DS40 Desoldering/Repair Tool

Valuable repair tool for servicing printed circuit boards and solid state electronics.
Components can be removed and replaced quickly with less chance of heat damage.
Complete unit includes 40w tool, vacuum bulb, desoldering assembly with DST4 tiptlet.

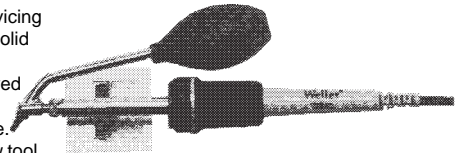

DS40 Desoldering tool Price \$84.01

WDP Series Manual Desoldering Pump



Removes molten solder from printed circuit boards and electronic components.
Plunger seal spring creates an extremely strong suction.
Features a push button plunger release and lightweight aluminum body that

withstands high temperatures.
Tips unscrew to allow easy removal of accumulated solder debris.
Standard and Teflon tips are available.
WDP-12 Desoldering pump Price \$20.68

Triplets for Desoldering Tools

Threaded - DS110 to DS117

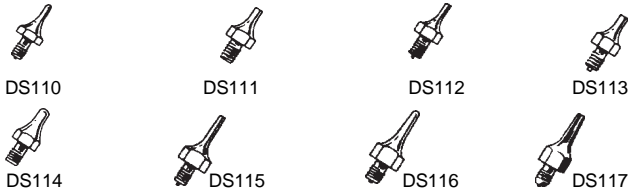

Part No.	O.D. "/mm	In Diam. "/mm	Reach "/mm	Price
DS110	0.06/1.52	0.02/0.63	0.50/12.70	\$13.80
DS111	0.09/2.28	0.02/0.63	0.50/12.70	13.80
DS112	0.07/1.93	0.03/0.91	0.50/12.70	13.80
DS113	0.09/2.48	0.04/1.16	0.50/12.70	13.80
DS114	0.12/3.25	0.07/1.80	0.50/12.70	13.80
DS115	0.06/1.52	0.02/0.63	0.75/19.05	13.80
DS116	0.09/2.48	0.04/1.14	0.75/19.05	13.80
DS117	0.09/2.28	0.02/0.63	0.75/19.05	13.80

Tapered - DS110T to DS117T

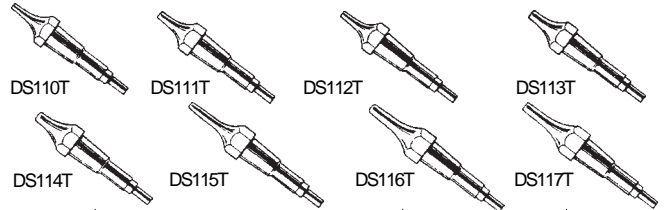

Part No.	O.D. "/mm	In Diam. "/mm	Reach "/mm	Price
DS110T	0.06/1.52	0.02/0.63	0.50/12.70	\$13.80
DS111T	0.09/2.28	0.02/0.63	0.50/12.70	13.80
DS112T	0.07/1.93	0.03/0.91	0.50/12.70	13.80
DS113T	0.09/2.48	0.04/1.16	0.50/12.70	13.80
DS114T	0.12/3.25	0.07/1.80	0.50/12.70	13.80
DS115T	0.06/1.52	0.02/0.63	0.75/19.05	13.80
DS116T	0.09/2.48	0.04/1.14	0.75/19.05	13.80
DS117T	0.09/2.28	0.02/0.63	0.75/19.05	13.80

Consumer Products

WCC100 Electronic Soldering Station

Electronically controlled station, with compact design is ideal for the novice soldering buff. 40 watt soldering pencil is fitted with an ETA tip and can be used with all Weller ET series tips. Temperature is adjustable from 350°F to 850°F. Zero voltage circuit ensures that no high voltage spikes or magnetic fields are present at tip to damage sensitive components. 3-wire grounded power cord, UL-recognized.

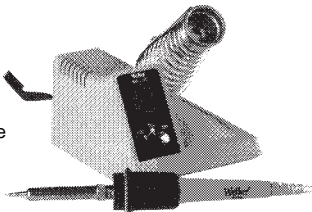

WCC100 Complete station w/40w iron Price \$125.10

Controlled-Output Field Soldering Irons

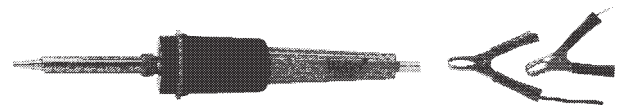

Versatile controlled tool for field servicing. Operates from batteries or low voltage power source. Complete with battery clips and 12' fused cord. Comes with PTD7 tip and heats up to 700°F. UL Listed
TCP12P Field soldering iron Price \$99.01

Soldering Gun - Universal (140/100 watts)

All purpose gun. Fingertip trigger selection of high or low output. Ready to solder in 6 seconds. High efficiency tin plated, copper tip. Light illuminates work. UL-listed.

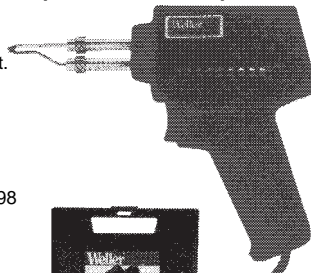

Model 8200 Soldering gun Price \$36.98

Soldering Gun-Professional (260/200 watts)

Heavy duty gun. Highest output gun w/2-position trigger selection. Heavy gage, high efficiency, tin plated copper tip. Comes up to temperature in 6 seconds. Twin lights to illuminate work. UL-listed.

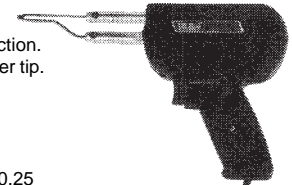

Model D550 Soldering gun Price \$50.25

Soldering Gun Kit-Universal (140/100watts)

8-piece kit with 8200 soldering gun. Includes 1 soldering tip; 1 sealing tip; 1 cutting tip; flux brush; soldering aid tool; and coil of 60/40 rosin core solder. Sturdy plastic carrying case. UL-listed

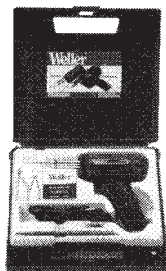

8200PK Soldering gun kit Price \$43.10

Soldering Gun Kit-Professional (260/200watts)

8-piece heavy duty kit with D550 soldering gun. Includes 1 soldering tip; 1 sealing tip; 1 cutting tip; flux brush; soldering aid tool; and coil of 60/40 rosin core solder. Sturdy plastic carrying case. UL-listed



D550PK Soldering gun kit Price \$58.46

Replacement Tips for Soldering Guns



Iron Plated Tip

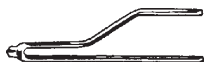

Standard Tip



Cutting Tip



Smoothing Tip

Part No.	Description	Price
Cutting Tip		
6110	Tip with hex nut for 8200/9200K	\$4.31
6130	Tip with hex nut for D550	4.31
6130AN	Tip w/hex nut inserts & acorn nuts for D550	4.31
6150	Tip only for 8200/D550	4.31
Smoothing Tip		
6120	Tip with hex nut for 8200/9200K	4.31
6140	Tip with hex nut for D550	4.31
6140AN	Tip with acorn nut for D550	4.31
6160	Tip only for 8200/D550	4.03

Part No.	Description	Price
Standard Tip		
7135	Tip only-2 per card for 8200/9200K	\$4.31
7135N	Tip with hex nut for 8200	4.31
7235	Tip only-2 per card for 7200	3.20
7250	Tip only-2 per card for D550	4.31
7250AN	Tip with hex nut for D550	4.31
Iron Plated Tip		
8125	Tip only 2-per card for 8200	4.31
8125N	Tip with hex nut for 8200	4.31

Accessory Products - Iron Stands

PH1201ESD

Soldering tool stand with base, sponge and receptacle
For EC1201P, EC1201PESD, EC1201A, TC201P,
TC201PZ, TC201T and DS101P irons.

PH1201ESD Iron stand assembly Price \$22.71

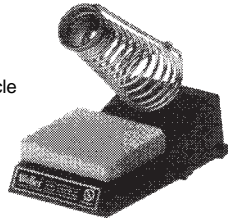

PH1301ESD

Soldering tool stand with base, sponge and receptacle
For EC1301P, EC1301ESD, EC1301R, EC1302,
EC1302R, EC1302A irons.

PH1301ESD Iron stand assembly Price \$22.98



PH100

Soldering tool stand with base, sponge and receptacle
For WP100PG iron and irons with barrel
diameter up to 19/32".

PH100 Iron stand assembly Price \$24.06



PHM120

Soldering tool stand with base, sponge and receptacle
For WM120

PHM120 Iron stand assembly Price \$25.60

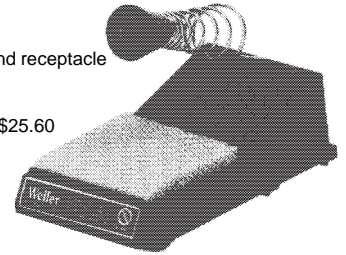

PH60

Soldering tool stand with base, sponge and receptacle
For W60P and "WP" series irons and irons with
barrel diameter up to 15/32".

PH60 Iron stand assembly Price \$21.33

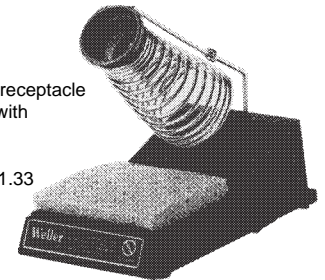

Spring and Funnel Assemblies

TC204

To attach to tool stand, wall or bench.
For EC1201A, EC1201P, EC1201PESD,
TC201T, TC201P, TC201PZ and DS101P irons.

TC204 Price \$5.98



IHF225EC

To attach to tool stand, wall or bench.
For EC1302A, EC1302, EC1301, EC1301ESD
EC1301R and WM120 irons.

IHF225EC Price \$6.31

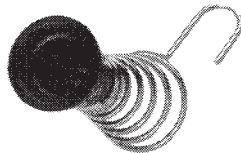

SFA60

To attach to tool stand, wall or bench.
For PH60 tool stand. W60P, "W" series
irons and irons with barrel diameter up
to 15/32".

SFA60 Price \$8.08

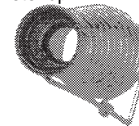

SFA100

To attach to tool stand, wall or bench.
For PH100 tool stand. W100PG irons
and irons with barrel diameter up to 15/32".

SFA100 Price \$13.56

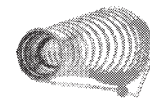

ACCESSORIES

TC205 SPONGE

One standard size fits all Weller soldering
and desoldering tool stands.

TC205 Sponge Price \$1.68



RC60V SOLDER

13 ft. /3.96 x .040" diameter.
60/40 premium-alloy, activated rosin-core solder
Especially formulated for electronics work.
Dispenser tube with hang-up eye.

RC60V Rosin core solder Price \$4.71

