



Handy Little Relay 24VDC



Supply Voltage
24VDC

Coil Resistance
1200Ω

Nominal Current
25mA

Output
Two Pole Change
Over relay contacts,
volt free (dry).

Rated at
8A at 240VAC
8A at 30VDC

Indicator
Red LED

Dimensions
33mm W x 53mm L x
28mm H

NOTE: This relay is polarised, suitable for fire alarm circuits and must be wired correctly for it to operate.

Plastic mounting feet are available – order SFSA for a pack of 20

Circuit diagram

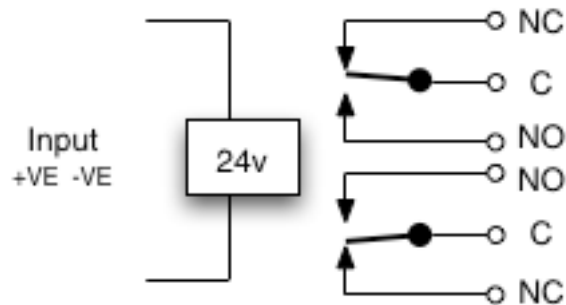

This relay is polarised and is therefore suitable for alarm bell circuits. It must be wired the correct way round for it to operate. There is also a back EMF suppressing diode.

Sample Applications

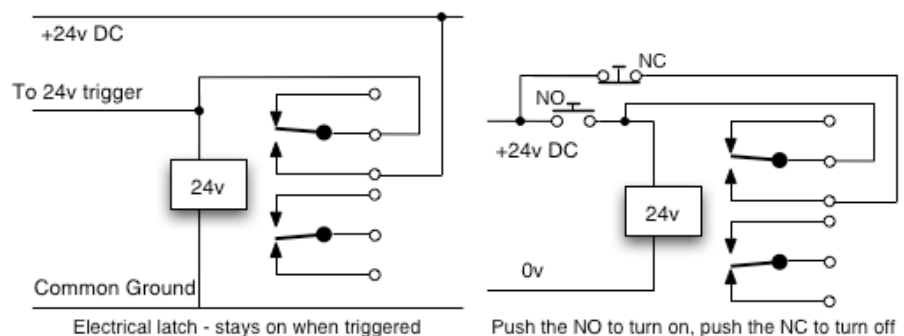
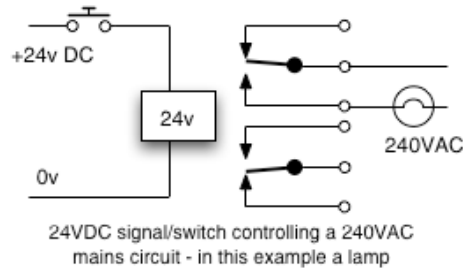

T.K. Consultants (UK) Ltd

Tel: 0845 43 00 33 5

Fax: 0845 43 00 33 6

Email: info@tk-

consultants.co.uk

Web: www.tk-consultants.co.uk

HLR24

Handy Little Relay 24VDC