

SKKD 100, SKMD 100



SEMIPACK® 1

Rectifier Diode Modules

SKKD 100

SKMD 100

Features

- Heat transfer through aluminium oxide ceramic isolated metal baseplate
- Hard soldered joints for high reliability
- SKKD half bridge connection
center-tap connections
SKMD common cathode
- UL recognized, file no. E 63 532

Typical Applications

- Non-controllable rectifiers for AC/AC converters
- Line rectifiers for transistorized AC motor controllers
- Field supply for DC motors

V_{RSM} V	V_{RRM} V	$I_{FRMS} = 175$ A (maximum value for continuous operation) $I_{FAV} = 100$ A (sin. 180; $T_c = 85$ °C)	
500	400	SKKD 100/04	SKMD 100/04
900	800	SKKD 100/08	SKMD 100/08
1300	1200	SKKD 100/12	
1500	1400	SKKD 100/14	SKMD 100/14
1700	1600	SKKD 100/16	SKMD 100/16
1900	1800	SKKD 100/18	

Symbol	Conditions	Values	Units
I_{FAV}	sin. 180; $T_c = 85$ (100) °C	100 (67)	A
I_D	P3/180; $T_a = 45$ °C; B2 / B6	73 / 91	A
	P3/180F; $T_a = 35$ °C; B2 / B6	150 / 190	A
I_{FSM}	$T_{vj} = 25$ °C; 10 ms	2500	A
	$T_{vj} = 125$ °C; 10 ms	2000	A
i^2t	$T_{vj} = 25$ °C; 8,3 ... 10 ms	31250	A ² s
	$T_{vj} = 125$ °C; 8,3 ... 10 ms	20000	A ² s
V_F	$T_{vj} = 25$ °C; $I_F = 300$ A	max. 1,35	V
$V_{(TO)}$	$T_{vj} = 125$ °C	max. 0,85	V
r_T	$T_{vj} = 125$ °C	max. 1,3	mΩ
I_{RD}	$T_{vj} = 125$ °C; $V_{RD} = V_{RRM}$	max. 5	mA
$R_{th(j-c)}$	per diode / per module	0,35 / 0,175	K/W
$R_{th(c-s)}$	per diode / per module	0,2 / 0,1	K/W
T_{vj}		- 40 ... + 125	°C
T_{stg}		- 40 ... + 125	°C
V_{isol}	a. c. 50 Hz; r.m.s.; 1 s / 1 min.	3600 / 3000	V~
M_s	to heatsink	5 ± 15 %	Nm
M_t	to terminals	3 ± 15 %	Nm
a		5 * 9,81	m/s ²
m	approx.	95	g
Case	SKKD	A 10	
	SKMD	A 33	

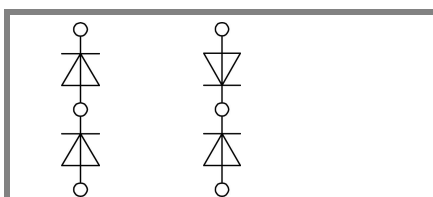

SKKD

SKMD

SKKD 100, SKMD 100

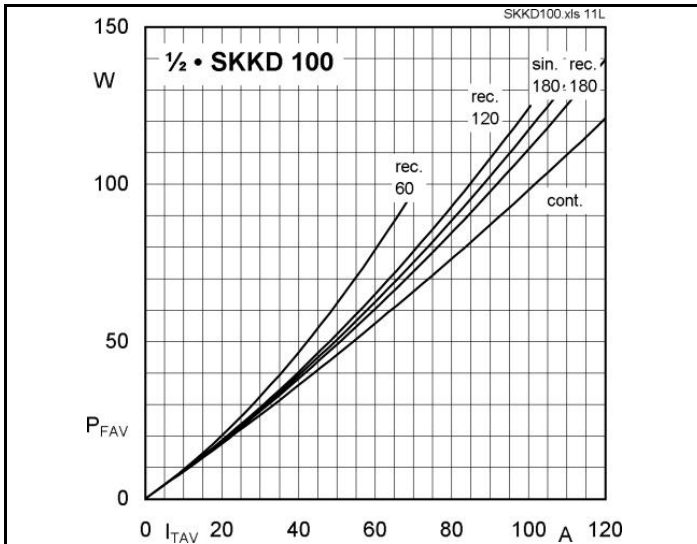

Fig. 11L Power dissipation per diode vs. forward current

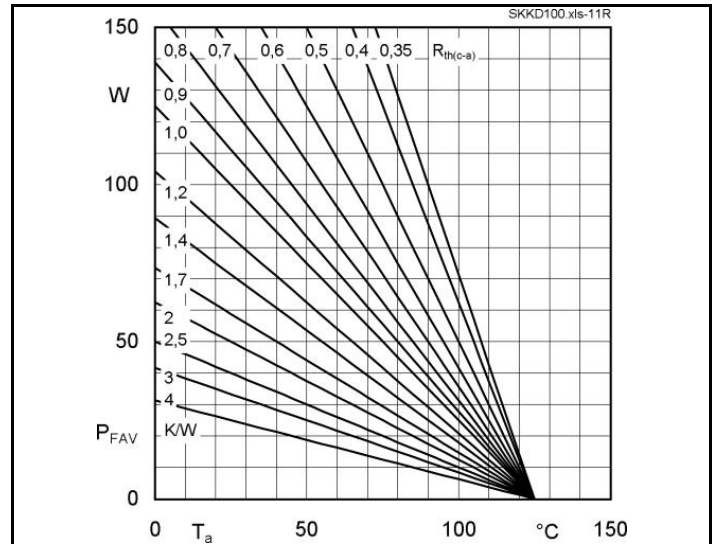

Fig. 11R Power dissipation per diode vs. ambient temperature

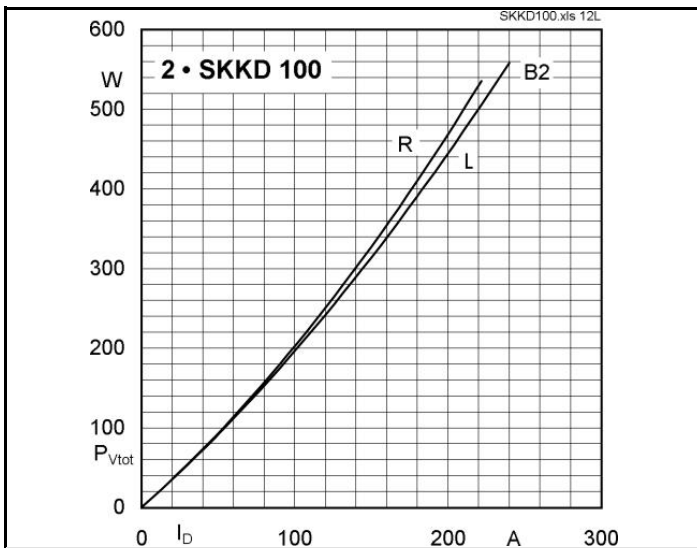

Fig. 12L Power dissipation of two modules vs. direct current

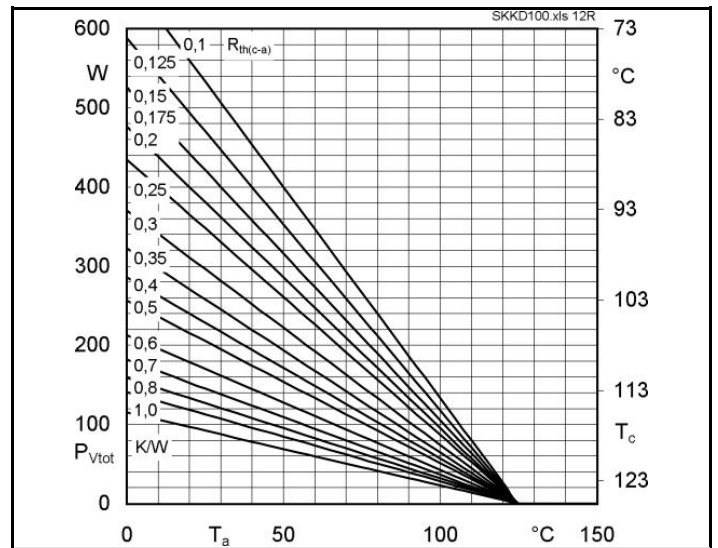

Fig. 12R Power dissipation of two modules vs case temperature

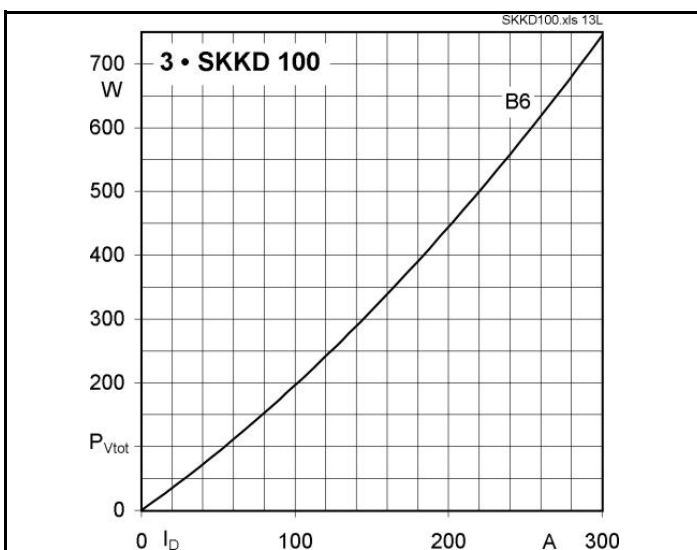

Fig. 13L Power dissipation of three modules vs. direct current

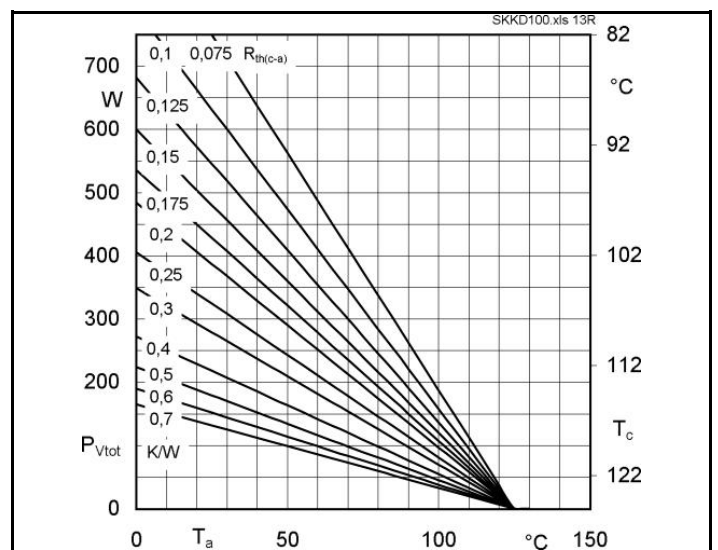
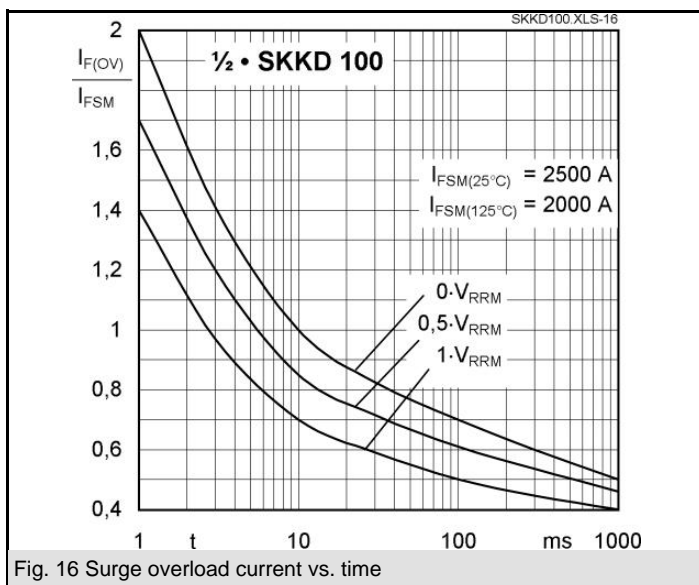
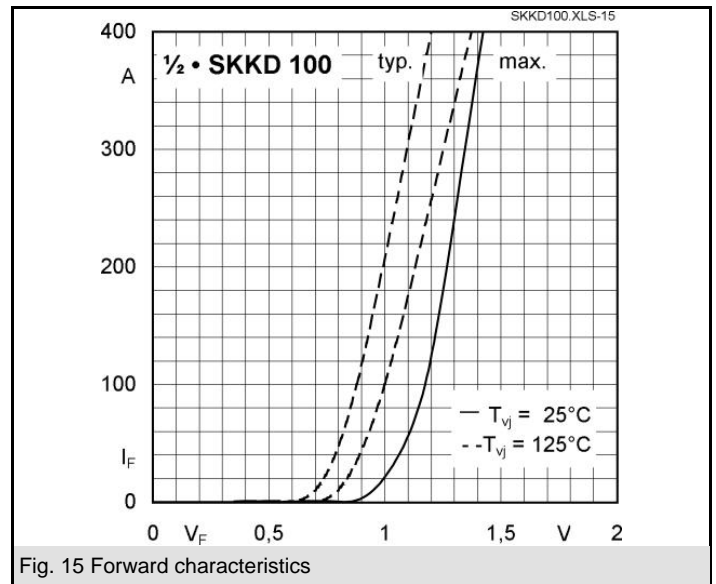
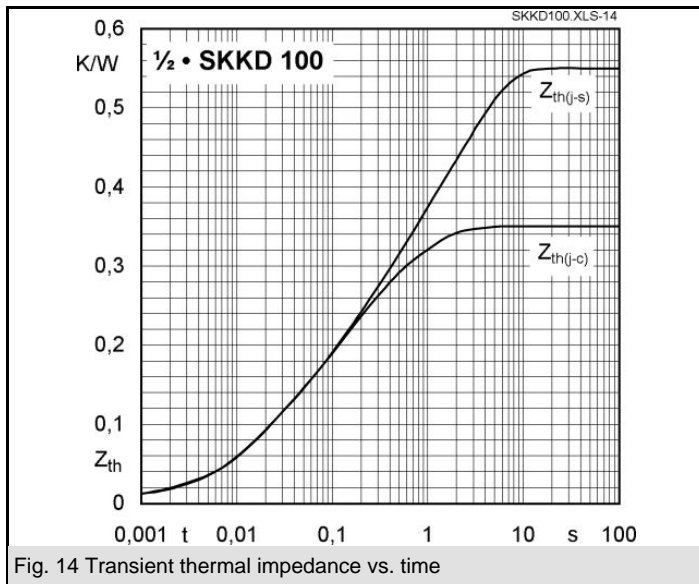
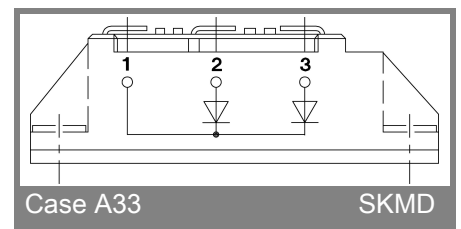
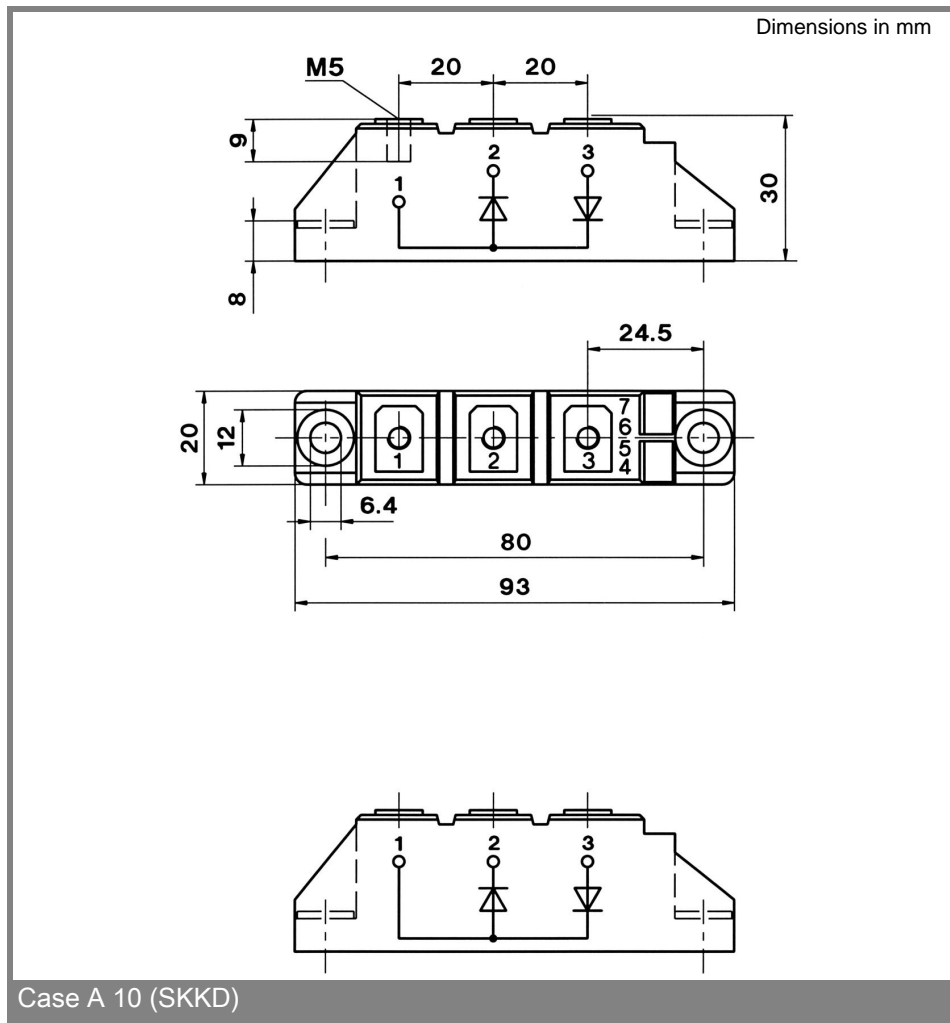

Fig. 13R Power dissipation of three modules vs. case temperature



SKKD 100, SKMD 100



This technical information specifies semiconductor devices but promises no characteristics. No warranty or guarantee expressed or implied is made regarding delivery, performance or suitability.