

RKU

RKUE

Anschlussleitung, M23-Kupplung mit Schraubverschluss (RKUE: mit Erdung) und angespritztem Kabel – für den Anschluss von steckbaren Aktor-/Sensor-Boxen –

Cordset, single-ended, M23 female connector with threaded joint (RKUE: with connected protective earth) and molded cable – to connect pluggable actuator/sensor distribution boxes –

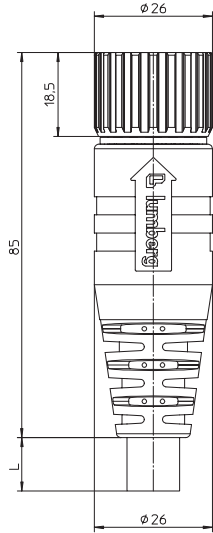

RKWU

RKWUE

Anschlussleitung, M23-Winkelkupplung mit Schraubverschluss (RKWUE: mit Erdung) und angespritztem Kabel – für den Anschluss von steckbaren Aktor-/Sensor-Boxen –

Cordset, single-ended, M23 female right angle connector with threaded joint (RKWUE: with connected protective earth) and molded cable – to connect pluggable actuator/sensor distribution boxes –

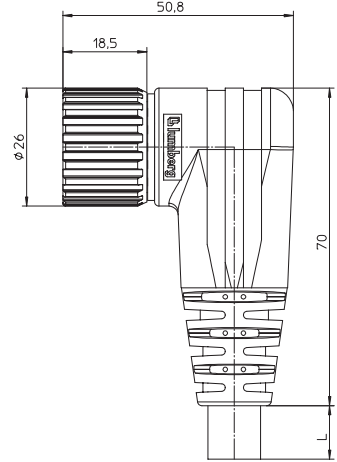

Pinbelegung
Pin assignment

12-polig
12 poles

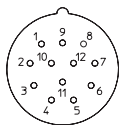

- 1 = weiß / white
- 2 = grün / green
- 3 = gelb / yellow
- 4 = grau / grey
- 5 = grau/rosa / grey/pink
- 6 = rot/blau / red/blue
- 7 = weiß/grün / white/green
- 8 = braun/grün / brown/green
- 9 = blau / blue
- 10 = blau / blue
- 11 = braun / brown
- 12 = gelb/grün / yellow/green

19-polig
19 poles

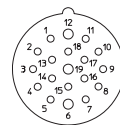









- 1 = violett / violet
- 2 = rot / red
- 3 = grau / grey
- 4 = rot/blau / red/blue
- 5 = grün / green
- 6 = blau / blue
- 7 = grau/rosa / grey/pink
- 8 = weiß/grün / white/green
- 9 = weiß/gelb / white/yellow
- 10 = weiß/grau / white/grey
- 11 = schwarz / black
- 12 = gelb/grün / yellow/green
- 13 = gelb/braun / yellow/brown
- 14 = braun/grün / brown/green
- 15 = weiß / white
- 16 = gelb / yellow
- 17 = rosa / pink
- 18 = grau/braun / grey/brown
- 19 = braun / brown

Anschlussleitungen für Aktoren, Sensoren und Verteiler Cordsets, single-ended, for actuators, sensors and distribution boxes

Technische Daten	
Umgebungstemperatur	-25°C / +80°C
Werkstoffe	
Gehäuse / Griffkörper	TPU, selbstverlöschend
Kontaktträger	PBT
Kontakt	CuZn, unternickelt und 0,8 µm vergoldet
Gewindebuchse / Rändelschraube/-mutter / Sechskantschraube/-mutter / Hülse	CuZn, vernickelt
Mechanische Daten	
Schutzart	IP 67 Nur im verschraubten Zustand mit den dazugehörigen Gegenstücken.
Elektrische Daten	
Nennstrom bei 40°C	12-polig 8 A 19-polig 8 A Stift-Ø 1 mm, 10 A Stift-Ø 1,5 mm
Nennspannung	12-polig 240 V 19-polig 120 V
Bemessungsspannung	12-polig 250 V 19-polig 125 V
Prüfspannung	12-polig 2,5 kV eff./ 60 s 19-polig 1,5 kV eff./ 60 s
Isolationswiderstand	> 10 ⁹ Ω
Verschmutzungsgrad	3

Technical data	
Operating temperature range	-25°C / +80°C
Materials	
Housing / Molded body	TPU, self-extinguishing
Insert	PBT
Contact	CuZn, pre-nickel and 0.8 microns gold-plated
Receptacle shell / knurled screw/nut / hexagon screw/nut / sleeve	CuZn, nickel-plated
Mechanical data	
Degree of protection	IP 67 Only in locked position with its proper counterparts.
Electrical data	
Nominal current at 40°C	12 poles 8 A 19 poles 8 A pin Ø 1 mm, 10 A pin Ø 1.5 mm
Nominal voltage	12 poles 240 V 19 poles 120 V
Rated voltage	12 poles 250 V 19 poles 125 V
Test voltage	12 poles 2.5 kV eff./ 60 s 19 poles 1.5 kV eff./ 60 s
Insulation resistance	> 10 ⁹ Ω
Pollution degree	3

Bestellbezeichnung Designation		Polzahl Poles	Mantel Outer jacket	
RKU 12-256/... M	RKWU 12-256/... M	12	PUR halogenfrei / halogen free	  
RKU 19-242/... M	RKWU 19-242/... M	19	PUR halogenfrei / halogen free	  
RKUE 19-242/... M	RKWUE 19-242/... M	19	PUR halogenfrei / halogen free	  

Standardlängen: 5 M / 10 M / 15 M / 20 M
Andere Kabellängen oder Leitungsaufbauten auf Anfrage.

Standard lengths: 5 M / 10 M / 15 M / 20 M
Other cable lengths or cable specifications on request.