

538862



GC 25

### Presentation

TeSys GC contactors are designed for use in modular panels and enclosures. These contactors feature:

#### ■ Easy installation

- quick clip-on fixing and locking onto 35 mm omega rail,
- easy connection by means of ready-to-tighten, captive, pozidrive screw terminals.

#### ■ Compact size

All units have a common depth of 60 mm and width in modules of 17.5 mm (width of one module: 17.5 mm).

#### ■ User safety

- use of materials conforming to strictest fire safety standards,
- live parts protected against direct finger contact,
- completely safe operation,
- state indication on front panel.

### Standards

This range of modular contactors has been designed taking into account the requirements of international standard IEC 61095.

This standard is specific to "Electromagnetic contactors for domestic and similar use".

It has very strict requirements, meeting the expectations of users, with regard to the safety of equipment and persons in "premises and areas accessible to the public".

Conformity with this standard makes it possible to obtain the following quality labels without the need for additional tests: NF-USE, VDE, CEBC, etc.

### Applications

TeSys GC modular contactors are designed for switching all single-phase, 3-phase or 4-phase loads up to 100 A.

### Power switching

These contactors have multiple applications in industrial, agricultural and commercial premises, hospitals and the home, i.e. wherever switching of a specific supply is required:

- lighting,
- heating,
- ventilation,
- motorised shutters or gates.

### Setting-up precautions

The contactor controls must be bounce free. If not, connect a coil suppression block **1** (GAP 21, 22 or 23) across the coil terminals  $\leq 250$  V.

When several contactors which operate at the same time are mounted side by side, a GAC 5 ventilation 1/2 module **2** must be fitted every 2 contactors.

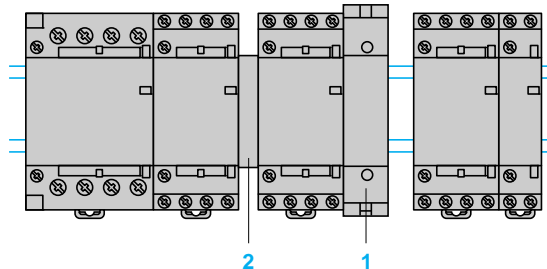

It is advisable to mount electronic units at the bottom of the modular panel and to separate them from electromechanical units by a space **3** equal to one module, or by 2 ventilation 1/2 modules (GAC 5).

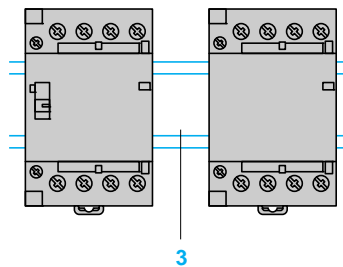

Derating of contactors mounted in a modular enclosure if the temperature within the enclosure is  $> 40$  °C

Contactor rating	40 °C	50 °C	60 °C (1)
16 A	16 A	14 A	13 A
25 A	25 A	22 A	20 A
40 A	40 A	36 A	32 A
63 A	63 A	57 A	50 A
100 A	100 A	87 A	80 A

(1) Ventilation 1/2 module must be fitted

Contactor type			GC16	GC25	GC40	GC63	GC100	
<b>Environment</b>								
Rated insulation voltage (Ui)	Conforming to IEC 61095	V	500					
	Conforming to VDE 0110	V	500					
Rated impulse withstand voltage (Uimp)		kV	4 in enclosure					
Conforming to standards			IEC 61095, VDE 0637-3 and IEC 60947-5 for auxiliary contacts					
Product certifications			NF- USE, VDE, CEBEC, ÖVE					
Degree of protection	Conforming to VDE 0106		Protection against direct finger contact (IP 20 open, IP 40 in enclosure)					
Protective treatment	Standard version		"TC"					
Ambient air temperature around the device	Storage	°C	- 40...+ 70					
	Operation	°C	- 5...+ 50 (0.85...1.1 Uc)					
Maximum operating altitude	Without derating	m	3000					
Operating positions	Without derating		± 30° in relation to normal vertical mounting plane					
Shock resistance 1/2 sine wave = 10 ms	Contactor open		10 gn					
	Contactor closed		15 gn					
Vibration resistance 5...300 Hz	Contactor open		2 gn					
	Contactor closed		3 gn					
Flame resistance			Conforming to IEC 61095					
<b>Pole characteristics</b>								
Number of poles			2, 3 or 4					
Rated operational current (Ie) (Ue ≤ 440 V)	In AC-7a (heating)	A	16	25	40	63	100	
	In AC-7b (motor control)	A	5	8.5	15	25	–	
Rated operational voltage (Ue)	Up to	V	250 two-pole contactors, 415 three and four-pole contactors					
Frequency limits	Of the operating current	Hz	400					
Conventional thermal current (Ith)	θ ≤ 50 °C	A	16	25	40	63	100	
Rated breaking and making capacity	Conforming to IEC 61095 (AC-7b) I rms 400 V 3-phase	A	40	68	120	200	–	
Permissible short time rating no current flowing for preceding 15 minutes with θ ≤ 40 °C	For 10 s	A	128	200	320	504	800	
	For 30 s	A	40	62	100	157	250	
Short-circuit protection by fuse or circuit breaker U ≤ 440 V	gl fuse	A	16	25	40	63	100	
	Circuit-breaker I <sub>pt</sub> 230 V (at 3 kA rms prospective)	A <sup>2</sup> s	5000	10 000	16 000	18 000	–	
	400 V	A <sup>2</sup> s	9000	14 000	17 500	20 000	–	
Average impedance per pole	At Ith and 50 Hz	mΩ	2.5	2.5	2	2	1	
Power dissipated per pole	For the above operational currents	W	0.65	1.6	3.2	8	10	
Maximum cabling c.s.a.	Flexible cable without cable end	1 conductor	mm <sup>2</sup>	6	6	25	25	35
		2 conductors	mm <sup>2</sup>	4	4	16	16	–
	Flexible cable with cable end	1 conductor	mm <sup>2</sup>	6	6	16	16	35
		2 conductors	mm <sup>2</sup>	1.5	1.5	4	4	–
	Solid cable without cable end	1 conductor	mm <sup>2</sup>	6	6	25	25	35
		2 conductors	mm <sup>2</sup>	4	4	6	6	10
Tightening torque	Power circuit connections	N.m	0.8	0.8	3.5	3.5	3.5	

Contactor type		GC16, GC25 single or 2-pole	GC16, GC25 3 or 4-pole GC40, GC63 2-pole	GC40, GC63 3 or 4-pole GC100 2-pole	GC100 4-pole		
<b>Control circuit characteristics</b>							
<b>Rated control circuit voltage (Uc)</b>	50 or 60 Hz	<b>V</b>	12...240 V, for other voltages, please consult your Regional Sales Office				
<b>Control voltage limits</b> ( $\theta \leq 50^\circ\text{C}$ )	50 Hz coils	Operational	0.85...1.1 U <sub>c</sub>				
		Drop-out	0.2...0.75 U <sub>c</sub>				
<b>Average coil consumption</b> at 20 °C and at U <sub>c</sub>	~ 50 Hz	Inrush	<b>VA</b>	15	34	53	106
		Sealed	<b>VA</b>	3.8	4.6	6.5	13
<b>Maximum heat dissipation</b>	50/60 Hz	<b>W</b>	1.3	1.6	2.1	4.2	
<b>Operating time</b>	Closing "C"	<b>ms</b>	10...30				
	Opening "O"	<b>ms</b>	10...25				
<b>Mechanical durability</b>	In operating cycles		10 <sup>6</sup>				
<b>Maximum operating rate</b> at ambient temperature $\leq 50^\circ\text{C}$	In operating cycles per hour		300				
<b>Maximum cabling c.s.a.</b>	Flexible cable without cable end	1 or 2 conductors	<b>mm<sup>2</sup></b>	2.5			
	Flexible cable with cable end	1 conductor	<b>mm<sup>2</sup></b>	2.5			
		2 conductors	<b>mm<sup>2</sup></b>	1.5			
	Solid cable without cable end	1 or 2 conductors	<b>mm<sup>2</sup></b>	1.5			
<b>Tightening torque</b>		<b>N.m</b>	0.8				
<b>Instantaneous auxiliary contact characteristics</b>							
<b>Rated operational voltage (U<sub>e</sub>)</b>	Up to	<b>V</b>	250				
<b>Rated insulation voltage (U<sub>i</sub>)</b>	Conforming to IEC 60947-5	<b>V</b>	500				
	Conforming to VDE 0110	<b>V</b>	500				
<b>Conventional thermal current (I<sub>th</sub>)</b>	For ambient $\theta \leq 50^\circ\text{C}$	<b>A</b>	5				
<b>Mechanical durability</b>	Operating cycles		10 <sup>6</sup>				
<b>Maximum cabling c.s.a.</b>	Flexible or solid conductor	<b>mm<sup>2</sup></b>	2.5				
<b>Tightening torque</b>		<b>N.m</b>	0.8				

528285



GC 2520

528286



GC 4040

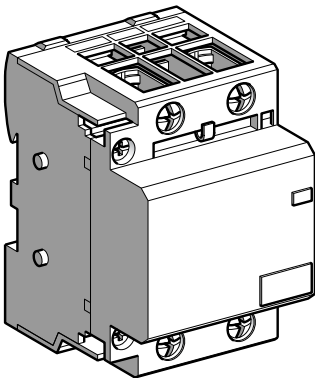

GC 10020

### Standard contactors, TeSys GC

Maximum current rating category AC-7a	No. of poles 	Number of 17.5 mm modules	Sold in lots of	Basic reference, to be completed by adding the voltage code (1)	Weight	
A					kg	
16	1	–	1	12	GC 1610●●	0.110
	2	–	1	12	GC 1620●●	0.110
	3	–	2	6	GC 1630●●	0.230
	4	–	2	6	GC 1640●●	0.230
	1	1	1	12	GC 1611●●	0.110
	2	2	2	6	GC 1622●●	0.230
25	1	–	1	12	GC 2510●●	0.110
	2	–	1	12	GC 2520●●	0.110
	3	–	2	6	GC 2530●●	0.230
	4	–	2	6	GC 2540●●	0.230
	1	1	1	12	GC 2511●●	0.110
	2	2	2	6	GC 2522●●	0.230
	–	2	1	12	GC 2502●●	0.110
	–	4	2	6	GC 2504●●	0.230
40	2	–	2	6	GC 4020●●	0.230
	3	–	3	4	GC 4030●●	0.350
	4	–	3	4	GC 4040●●	0.390
	1	1	2	6	GC 4011●●	0.230
	2	2	3	4	GC 4022●●	0.390
	–	2	2	6	GC 4002●●	0.230
	–	4	3	4	GC 4004●●	0.390
63	2	–	2	6	GC 6320●●	0.340
	3	–	3	4	GC 6330●●	0.390
	4	–	3	4	GC 6340●●	0.390
	1	1	2	6	GC 6311●●	0.340
	2	2	3	4	GC 6322●●	0.390
	–	2	2	6	GC 6302●●	0.340
100	2	–	3	4	GC 10020●●	0.680
	4	–	6	2	GC 10040●●	0.780

(1) Standard control circuit voltages (for other voltages, please consult your Regional Sales Office):

Volts	12	24	48	110	220/240
50 Hz	J5	B5	E5	F5	M5
60 Hz	J6	B6	E6	F6	M6

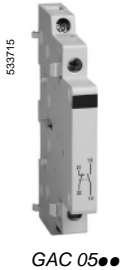

GAC 05●●



GAP 2●

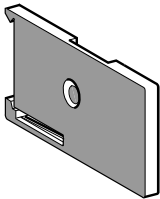

GAC 5

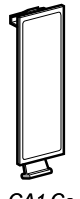

GA1 C●

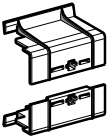

GW 254

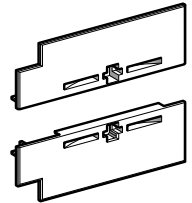

GW 63●

Instantaneous auxiliary contact blocks					
Number of contacts	No. of poles			Reference	Weight kg
2	1	1	-	GAC 0521	0.016
-	-	2	-	GAC 0531	0.016
-	-	-	1	GAC 0511	0.016

Accessories						
Description	For use on contactor	Number of modules	Operational voltage	Sold in lots of	Unit reference	Weight kg
			V			
Coil suppression blocks comprising 2 RC circuits	-	1	12...48	1	GAP 21	0.090
	-	-	110...240	1	GAP 23	0.090
Ventilation 1/2 module Clips onto rail	-	1/2	-	10	GAC 5	0.015
Cover plates	-	1/2	-	10	GA1 C7	0.001
		1	-	10	GA1 C6	0.001
Set of sealable terminal covers (10 top parts + 10 bottom parts)	16 or 25 A 3 or 4 contacts	2	-	1	GW 254	0.040
	40 or 63 A 2 contacts	2	-	1	GW 632	0.040
	40 or 63 A 3 or 4 contacts	3	-	1	GW 634	0.050

### Dimensions

#### Contactors

##### Common side view

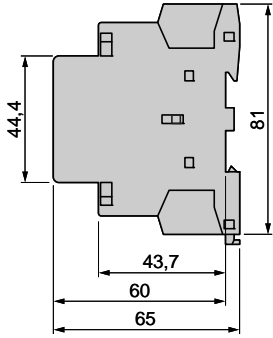

GC 1610, 1611, 1620  
GC 2502, 2510, 2511, 2520

1 module



GC 1622, 1640  
GC 2504, 2522, 2530, 2540

2 modules

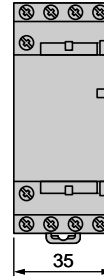

##### Common side view

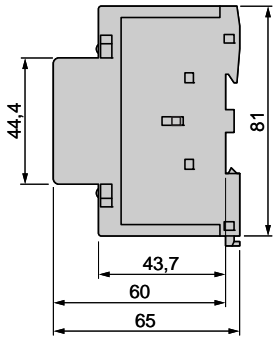

GC 4002, 4011, 4020  
GC 6302, 6311, 6320

2 modules

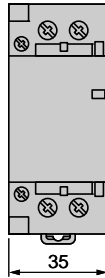

GC 4004, 4022, 4030, 4040  
GC 6304, 6322, 6330, 6340

3 modules

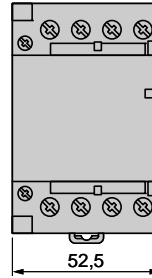

##### Common side view

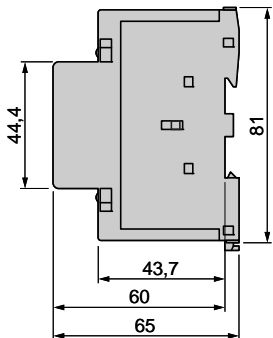

GC 10020

3 modules

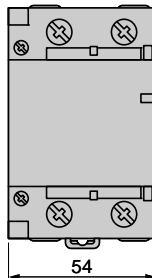

GC 10040

6 modules

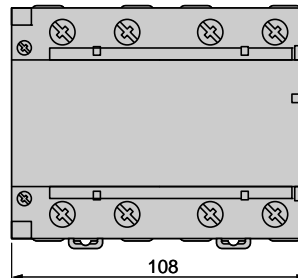

**Dimensions**

**Auxiliary contacts**

GAC 0511, 0531 and 0521

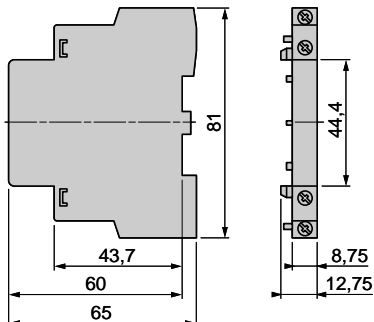

**Coil suppression blocks**

GAP 21, 22 and 23

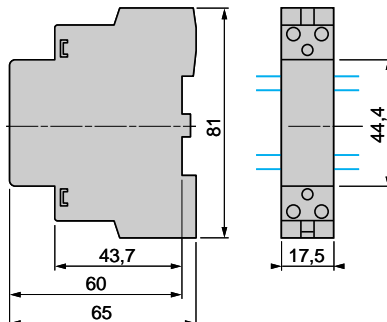

**Clip-on ventilation 1/2 module**

GAC 5

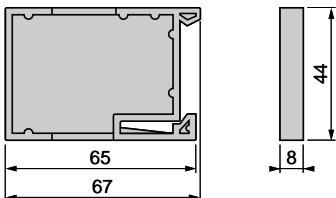

**Cover plates**

GA1 C6

GA1 C7

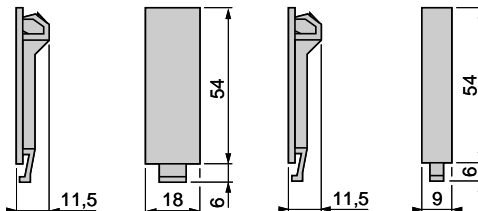

**Schemes**

**Contactors**

GC ●●10

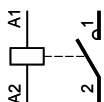

GC ●●20

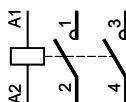

GC ●●30

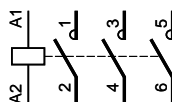

GC ●●40

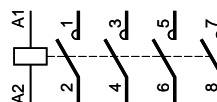

GC ●●11

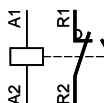

GC ●●22

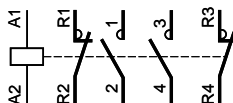

GC ●●02

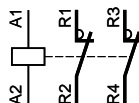

GC ●●04

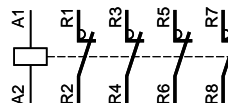

**Auxiliary contacts**

GAC 0521

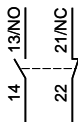

GAC 0531

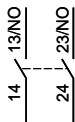

GAC 0511

