

IEC Appliance Outlet F, Screw-on Mounting, Rear Side, PCB-/Solder Terminal

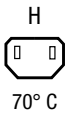
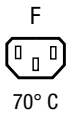
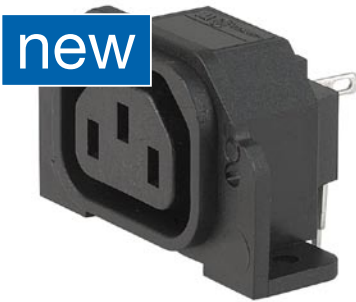

Description

- Panel Mount:
Screw-on mounting from rear-side
- Connector, Pin temperature 70 °C, protection class I or II
- For PCB mounting

Approvals

- VDE Certificate Number: -
- UL File Number: -
- CSA File Number: 1896151

Other versions on request

- For protection class II

References

Substitute for type [P675/PC](#)
Alternative: protection class II version

Weblinks

[pdf](#), [html](#), [General Product Information](#), [Approvals](#), [RoHS](#), [CHINA-RoHS](#), [Mating Connectors](#), [e-Store](#), [SCHURTER-Stock-Check](#), [Distributor-Stock-Check](#), [Accessories](#)

Technical Data

Ratings IEC	10A / 250VAC; 50Hz
Ratings UL/CSA	15A / 250VAC; 60Hz
Dielectric Strength	> 4 kVAC between L-N > 2 kVAC between L/N-PE (1 min/50Hz)
Allowable Operation Temp.	-25 °C to 70 °C
Degree of Protection	from front side IP 20 acc. to IEC 60529
Protection Class	Suitable for appliances with protection class 1 or 2 acc. to IEC 61140
Terminal	For PCB mounting ; Ground terminal: Solder terminal straight
Material: Housing	PA6, black / grey / white, UL 94V-0

Appliance Outlet	F acc. to IEC/EN 60320-2-2, UL 498, CSA C22.2 no. 42 (for cold conditions) pin-temperature 70 °C, 10A, Protection Class 1 or 2
------------------	---

Dimensions

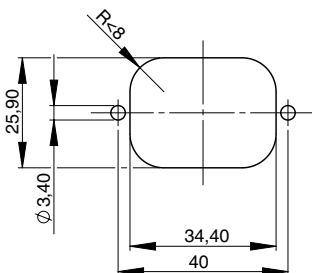

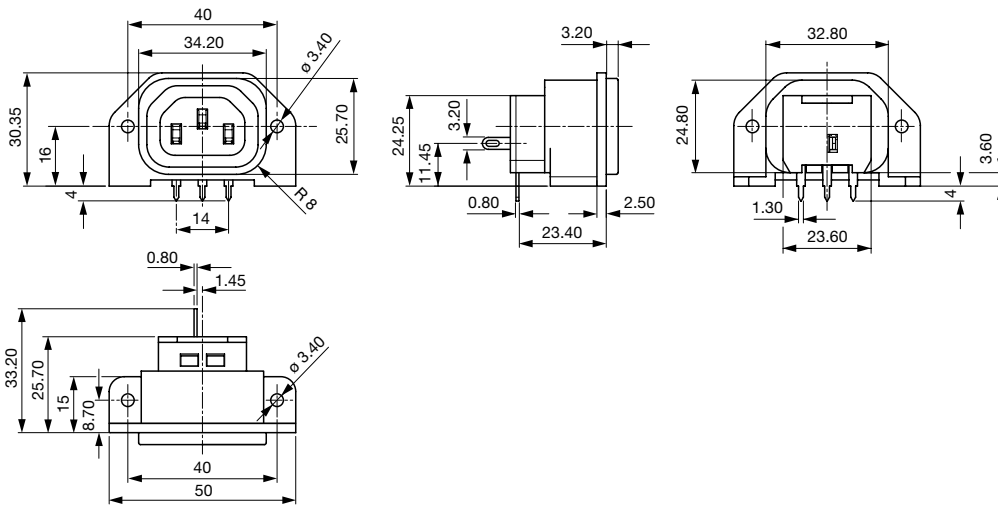

Drilling diagrams

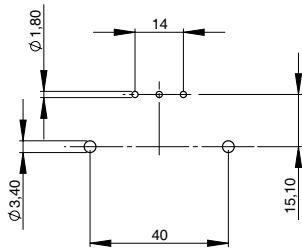

Config. Code

5001 - H - A B C 0- D - E O

The characters are placeholders for the correspondingly keys of selections from the key tables.

5001 - H - A B C 0- D - E O = Type

Type	Configuration key
protection class 2	B
protection class 1	X

5001 - H - A B C 0- D - E O = Terminals

Terminal L	Configuration key
PCB-terminal (standard) 	4

5001 - H - A B C 0- D - E O = Terminals

Terminal N	Configuration key
PCB-terminal (standard)	4
Symbols similar as in table A	

5001 - H - A B C 0- D - E O = Terminals

Terminal Ground	Configuration key
without terminal	0
PCB-terminal (long)	6
Symbols similar as in table A	

5001 - H - A B C 0- D - E O = Color

Color	Configuration key
jet black; RAL9005	A
silver grey; RAL7001	B
pure white; RAL9010	D

5001 - H - A B C 0- D - E O = Style

Style	Configuration key
flange with through holes	2
flange with through holes (special type)	7

5001 - H - A B C 0- D - E O = Features

Features	Configuration key

Variants

Config. Code	Description	Order Number
5001-X-4460-A-2	5001, IEC Connector F, 70°C1 or 2, L: PCB-terminal (standard), N: PCB-terminal (standard), ground: PCB-terminal (long), color: jet black; RAL9005, design: flange with through holes	6182.0033

The listed variants should be available from stock Other versions on request www.schurter.com/contact

Packaging unit 50 Pcs

Mating Inlets/Plugs

Category / Description

[Interconnection CordOverview complete](#)

Interconnection Cord with IEC Plug E, Angled	0607
Interconnection Cord with IEC Plug E, Angled	0608
Interconnection Cord with IEC Plug E, Straight	0609
Interconnection Cord with IEC Plug G, Angled	607B
Interconnection Cord with IEC Plug G, Angled	608B
Interconnection Cordfurther types to5001	...

[PlugOverview complete](#)

IEC Plug E, Cord Connector (Rewireable), Straight, max. cable Diameter 8.5 mm	4732
IEC Plug E, Cord Connector (Rewireable), Angled, max. Cable Diameter 10 mm	4733
IEC Plug E, Cord Connector (Rewireable), Straight, max. Cable Diameter 10 mm	4735
IEC Plug E, Cord Connector (Rewireable), Angled, max. Cable Diameter 10 mm	4736
IEC Plug E, Cord Connector (Rewireable), Straight	9009

[Plugfurther types to5001](#)

...