

RG-59 Coax Cables



BELDEN RG-59/U Coaxial Cable

RG-59/U coaxial cable. 20AWG bare copper covered steel, Duofoil plus 40% aluminum braid, foam dielectric, black PVC Jacket. Mfr. #9275.

Order #	Length	(ea.)	(2-4)	(5-up)
24-5160	1000'	\$125.00	\$119.00	\$116.00
24-5165	500'	63.99	63.20	58.16

BELDEN RG-59/U Cable

Brilliance, 75ohm coax, 23AWG, solid bare copper covered steel, polyethylene, bare copper braid, 95% shield coverage, black PVC jacket. Outside diameter .240" nominal. Mfr. #8241.

Order #	Length	(ea.)	(2-4)	(5-up)
24-5200	1000'	\$361.00	\$349.00	\$342.00
24-5205	500'	196.00	190.00	186.00

BELDEN RG-59/U Precision Video Cable

Belden precision video cables are used in critical analog video circuits and high quality applications such as live broadcast in network studios and pre-or post-production facilities. They should be used anywhere superior signal integrity is required. 20AWG solid bare copper center conductor, foam polyethylene insulation, foil shield with 95% tinned copper braid provides 100% shield coverage, black PVC jacket suitable for indoor and outdoor applications. 75ohm. Brilliance precision video coax for analog and digital SDI/HDTV applications. Mfr. #1505A

Order #	Length	(ea.)	(2-4)	(5-up)
24-7555	1000'	\$386.00	\$379.00	\$374.00

BELDEN 1000' RG-59/U Coax Cable

RG-59/U coaxial cable. 20AWG bare copper covered steel, foam dielectric, Duobond II plus 40% aluminum braid, black PVC jacket. Mfr. #9100.

Order #	(ea.)	(2-4)	(5-up)
24-5150	\$117.00	\$111.00	\$109.00

BELDEN RG-59/U

Special application, TV camera cables and CCTV cables, brilliance, RG-59/U Type, 22AWG, stranded (7x30) bare copper, foam polyethylene, bare copper braid, 95% shield coverage, black PVC jacket, for CCTV applications. Mfr. #9259.

Order #	Length	(ea.)	(2-4)	(5-up)
24-5190	1000'	\$433.00	\$419.00	\$410.00
24-5195	500'	212.00	211.00	210.00

RG-8 Coax Cable

RG-8/U Cable

•13AWG (7 strands x 21 gauge) center conductor
•Black PVC insulation •Bare copper braid, 70% shield •Foam dielectric •.405" (O.D.) nominal •60ohm nominal impedance •22pF/ft nominal capacitance
•Attenuation/100' at 100MHz 2.0dB, 200MHz 3.0dB, 400MHz 4.5dB, 900MHz 6.8dB

Order #	Length	(ea.)	(2-4)	(5-up)
24-1565	50'	\$58.99	\$51.72	\$47.45
24-1570	100'	69.49	62.02	57.75
24-1575	500'	383.00	351.00	325.00

Stellar Labs™

RG-59/U

RG-59/U coaxial cable with 20AWG copper covered steel, mylar foil and 60% aluminum braid providing 100% shield coverage. Sweep tested to 2250MHz. Polyethylene dielectric and PVC jacket. OD .240" nominal. Impedance: 75ohm nominal. Sequential feet marking every two feet.

Order #	Length	(1-7)	(8-up)
Black			
24-10270	500'	\$30.49	\$24.45
24-10271	1000'	60.99	48.92
White			
24-10275	500'	30.49	24.45
24-10276	1000'	60.99	51.91

Stellar Labs™

RG-59/U with Copper Braid

•22 gauge solid copper-covered steel weld •Foam dielectric •80% nominal copper braid shield •.240" (O.D.) nominal •75ohm nominal impedance

Order #	Length	(1-3)	(4-8)	(9-up)
24-10265	500'	\$41.49	\$39.14	\$37.08
24-10266	1000'	72.49	68.50	64.89

Stellar Labs™

RG-59/U Plus 18/2

RG-59/U siamese coaxial cable with 20AWG copper covered steel, mylar foil and 60% aluminum braid providing 100% shield coverage. Sweep tested to 2250MHz. Polyethylene dielectric and PVC jacket. OD .250" nominal. Impedance: 75ohm nominal. Two conductor 18AWG bare copper stranded wire, PVC jacket, color coded for easy polarity identification. Sequential feet marking every two feet.

Order #	Length	(1-3)	(4-up)
24-10285	500'	\$90.99	\$78.29

Stellar Labs™

RG-59/U Plus 18/2 with Copper Braid

RG-59/U siamese coaxial cable perfect for installing cable television systems and closed circuit television systems. Constructed with one RG-59/U cable molded to a two conductor 18AWG cable.

Order #	Length	(1-3)	(4-8)	(9-up)
24-10280	500'	\$90.99	\$78.29	\$90.99
24-10281	1000'	169.00	146.00	169.00

Thomas & Betts

Snap-n-Seal® "F" Compression Connectors

The Snap-n-Seal® connector is designed to reduce assembly time and simplify installation. With its user-friendly, pre-positioned plastic sleeve and true 360° compression, this connector makes terminating coax drop cables fast and accurate. **Features:** •RF shielding performance to -90dB on 60% bonded foil cable •Cable retention exceeds 40lb. minimum as specified by the SCTE •Return loss: >30dB up to 1GHz •Insertion loss:<-.018dB up to 1GHz

Fig. Order #	Mfr. #	Cable Type	(1-4)	(5-9)	(10-49)	(50-up)
A 27-5845	SNS1P6	RG6	\$0.79	\$0.76	\$0.74	\$0.72
B 27-5846	SNS1P6QS	RG6 quad	0.79	0.76	0.74	0.72
C 27-5847	SNS1P59	RG59	0.79	0.76	0.74	0.72



NEW!

WIRE & CABLE



Section 10

Antenna Wire	157	HDMI	168-170
Audio Control Wire	156, 157	Heat Shrink	166-167
Audio/Video Cables	168-177	Hook-up Wire	157
Audio Snake Cables	178	Kynar Wire	157
Automotive Wire	160	Magnetic Wire	157
Cable Management	162-167	Microphone Cable	157
Coax Wire	153-155	Multi-conductor Wire	158-160
Component Video Cables	171	Speaker Wire	155, 156
Conduit	164	Speakon Cables	178
Control/Audio Wire	156, 157	S-Video Cables	173
		Taperwire	156
		Test Lead Wire	157
		Toslink Cable	175
		XLR Cables	178, 179

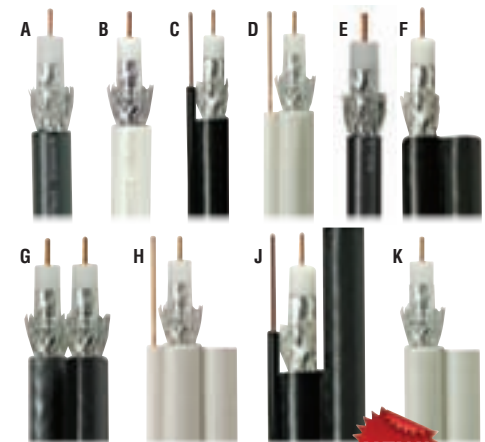

NEW!



RG-6/U Solid Copper Coax

RG-6/U cable with 18AWG solid copper center conductor, 60% aluminum braid and 100% aluminum foil shield. **Features:** •SBCA compliant •UL CM rated •PVC jacket with 6.86 nominal O.D. •Dielectric: gas injected foam PE with 4.57mm O.D. •Sweep tested to 3000MHz •Foot marking every 2' •Put-up: Reel-in-box

Fig. Order #	Mfr. #	(1-4)	(5-9)	(10-49)	(50-up)
1000' Single					
A 24-11080	PVCX1B	\$99.99	\$97.20	\$93.25	\$88.20
B 24-11081	PVCX1W	99.99	97.20	93.25	88.20
1000' Single with ground					
C 24-11082	PVCX4B	109.00	106.00	102.00	94.40
D 24-11083	PVCX4W	109.00	106.00	102.00	94.40
1000' Single quad					
E 24-11084	ULPVRG6SCQUAD	109.99	106.92	102.58	97.02
500' Dual					
F 24-11085	PVCX2B	104.00	99.69	94.44	91.55
G 24-11086	PVCX2W	104.00	99.69	94.44	91.55
500' Dual with ground					
H 24-11087	PVCX3B	109.00	106.00	102.00	94.40
J 24-11088	PVCX2W	109.00	106.00	102.00	94.40
500' Dual quad					
K 24-11089	ULPVRG6SCLQD	119.90	116.60	112.20	103.84





WIRE & CABLE

Section 10



RG-6/U
 RG-6/U coaxial cable with 18AWG copper covered steel, mylar foil and 60% aluminum braid providing 100% shield coverage. Sweep tested to 2250MHz. Polyethylene dielectric and PVC jacket. OD .275" nominal. Impedance: 75ohm nominal. Sequential foot marking every two feet.

Order #	Length	(1-3)	(4-8)
Black			
24-10205	500'	\$30.49	\$27.48
24-10206	1000'	55.99	48.04
White			
24-10210	500'	30.49	27.48
24-10211	1000'	55.99	48.04



RG-6/U with Solid Copper Center

RG-6/U coaxial cable with 18AWG solid bare copper center conductor, mylar foil and 60% aluminum braid providing 100% shield coverage. Sweep tested to 2250MHz. Polyethylene dielectric and PVC jacket. OD .280" nominal. Impedance: 75ohm nominal. Sequential foot marking every two feet.

Order #	Length	(1-3)	(4-8)
24-10220	500'	\$55.99	\$48.77
24-10221	1000'	88.99	78.08



RG-6/U CL2-Rated Coax Cable

RG-6/U type coax cable. 18AWG solid bare copper center conductor. Mylar aluminum foil shield plus 40% aluminum braid provides 100% shield. Foam dielectric and PVC jacket. Outside diameter .270" nominal. Impedance 75ohm nominal. Perfect cable for high frequency cable systems, satellite television and DBS. CL2 rated for in-wall use.

Order #	Length	(1-3)	(4-up)
24-10200	500'	\$45.49	\$39.14
24-10201	1000'	111.00	97.00



RG-6/U Quad Shield

RG-6/U coaxial cable with 18AWG copper covered steel, mylar foil and 60% aluminum braid conductor and dual mylar foil shields with 60%/40% aluminum braiding providing exceptional shielding. Sweep tested to 2250MHz. Polyethylene dielectric and PVC jacket. OD .30" nominal. Impedance: 75ohm nominal. Sequential foot marking every two feet.

Order #	Length	(1-3)	(4-up)
Black			
24-10225	500'	\$40.49	\$34.24
24-10226	1000'	70.99	63.01
White			
24-10230	500'	40.49	34.24
24-10231	1000'	70.99	58.71



RG-6/U Dual

Dual RG-6/U coaxial cable with 18AWG copper covered steel, mylar foil and 60% aluminum braid providing 100% shield coverage. Sweep tested to 2250MHz. Polyethylene dielectric and PVC jacket. OD .275" nominal. Impedance: 75ohm nominal. Sequential foot marking every two feet. Black.

Order #	Length	(1-3)	(4-up)
24-10215	500'	\$52.99	\$45.01
24-10216	1000'	90.99	78.29

RG-6 Coax Cables

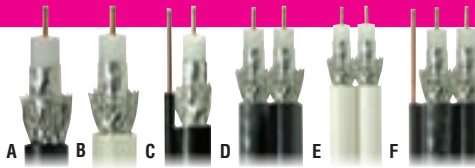

RG-6/U Copper-Clad Coax

RG-6/U cable with 18AWG copper covered steel center conductor, 60% aluminum braid and 100% aluminum foil shield. Features: •PVC jacket with 6.86 nominal O.D. •Dielectric: gas injected foam PE with 4.57mm O.D. •Sweep tested to 3000MHz •Foot marking every 2' •Put-up: Reel-in-box

Fig.	Order #	Mfr. #	Length	(1-4)	(5-9)	(10-49)	(50-up)
Single							
A	24-11055	PVRG6BLK	1000'	\$59.99	\$58.00	\$56.00	\$54.00
B	24-11056	PVRG6WHT	1000'	59.99	58.00	56.00	54.00
Single w/ ground							
C	24-11066	PVRG6GDBLK	1000'	69.99	67.00	66.00	63.00
Dual							
D	24-11060	PVRG6DUALBLK	500'	62.99	60.00	59.00	57.00
E	24-11061	PVRG6DUALWHT	500'	62.99	60.00	59.00	57.00
Dual w/ ground							
F	24-11065	PVRG6DUALGDBLK	500'	69.99	67.00	66.00	63.00

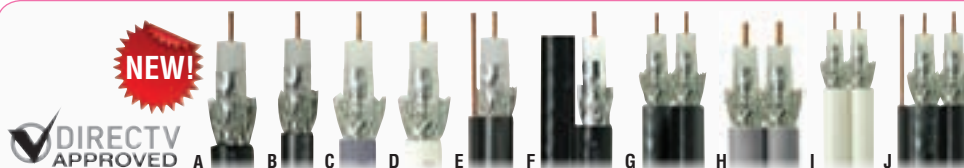

Approved RG-6/U Copper-Clad Coax

RG-6/U cable with 18AWG copper covered steel center conductor, 60% aluminum braid and 100% aluminum foil shield. Features: •PVC jacket with 6.86 nominal O.D. •Dielectric: gas injected foam PE with 4.57mm O.D. •Sweep tested to 3000MHz •UL CM and CMR rated •Foot marking every 2' •Put-up: Reel-in-box.

Fig.	Order #	Mfr. #	UL Rating	Length	(1-4)	(5-9)	(10-up)
Single							
A	24-11070	ULPVRG6BLK	CM	1000'	\$62.99	\$61.10	\$59.21
B	24-11071	ULPVRG6RB	CMR	1000'	72.99	69.89	67.79
C	24-11072	ULPVRG6RG	CMR	1000'	72.99	69.89	67.79
D	24-11073	ULPVRG6RW	CMR	1000'	72.99	69.89	67.79
Single w/ ground							
E	24-11074	ULPVRG6GDBLK	CM	1000'	69.99	69.89	67.79
Dual							
F	24-11075	ULPVRG6DUALBLK	CM	500'	59.99	58.19	56.39
G	24-11076	ULPVRG6DUALRB	CMR	500'	74.99	72.00	70.00
H	24-11077	ULPVRG6DUALRG	CMR	500'	74.99	72.00	70.00
I	24-11078	ULPVRG6DUALRW	CMR	500'	69.99	67.89	65.79
Dual w/ ground							
J	24-11079	ULPVRG6DUALGDBLK	CM	500'	69.99	67.89	65.79



RG-6/U Black Siamese Cable

RG-6/U coaxial cable with 18AWG copper covered steel, mylar foil and 60% aluminum braid providing 100% shield coverage. Sweep tested to 2250MHz. Polyethylene dielectric and PVC jacket. OD .275" nominal. Impedance: 75ohm nominal. 18AWG bare copper stranded wire, PVC jacket, color coded for easy polarity identification. Sequential foot marking every two feet.

Order #	Length	(1-3)	(4-up)
24-10245	500'	\$114.00	\$98.00
24-10246	1000'	222.00	188.00



RG-6/U White Siamese with Copper Center

RG-6/U coaxial cable with 18AWG solid bare copper center conductor, mylar foil and 60% aluminum braid providing 100% shield coverage. Sweep tested to 2250MHz. Polyethylene dielectric and PVC jacket. OD .280" nominal. Impedance: 75ohm nominal. Two 18AWG bare copper stranded wires in color coded PVC jacket for easy polarity identification. Sequential foot marking every two feet.

Order #	Length	(1-3)	(4-up)
24-10250	500'	\$92.99	\$88.07
24-10251	1000'	165.00	156.00



BELDEN Plenum Rated Coax Cable

Belden New Generation plenum coaxial cable. UL type CMP approval. Foam dielectric and natural Flamarrrest jacket. Key: BC=Bare Copper, FB= Foil plus braid.

Order #	Length	Ctr./ Shield	(ea.)	(2-4)	(5-up)
Mfr. # 633948					
24-4940	1000'	6 BC/BC	\$577.00	\$568.00	\$556.00
24-4945	500'	6 BC/BC	295.00	285.00	279.00
Mfr. # 633938					
24-4950	1000'	6 BC/FB	509.00	493.00	483.00



CAROL BRAND RG59/U Siamese Cable

Solid bare copper 20 AWG coax with 95% bare copper braid flexfoil shield. Unshielded 18 AWG (7/26) pair. Black (CM) or Natural (CMP) PVC jacket in reel put ups. Insulation: Foam PE (CM) or Fluoropolymer (CMP). Application: RF signal transmission, MATV, CCTV, CATV, LAN, Monitor/VDT Display, direct burial... Complies: UL CL2, CATV, CM c(UL) CM and UL CMP c(UL) CMP.

Order #	Carol ID	Rating	Length	ONLY
24-10625	C8028	CM	500'	\$142.00
24-10626	C8028	CM	1000'	282.00
24-10627	C8030	CMP	500'	216.00
24-10628	C8030	CMP	1000'	431.00

RG-6 Coax Cables

NEW!

CAROL BRAND RG-6/U

RG6/U coaxial cable 18AWG copper covered steel conductor with 60% aluminum braid and 100% aluminum-Mylar foil shield. Polyethylene dielectric and PVC jacket. Reel put-up. 

Order #	Carol ID	Rating	Length	Color	ONLY
24-10600	C5775	CM	500'	Black	\$38.49
24-10601	C5775	CM	1000'	Black	74.99
24-10603	C5886	CMR	1000'	Black	80.99
24-10604	C3524	CMP	500'	Natural	201.00
24-10605	C3524	CMP	1000'	Natural	403.00

CAROL BRAND RG-6/U Quad Shield

NEW!

RG6/UQS coaxial cable 18AWG copper covered steel, dual Mylar foil and braid shield with 60%-40% aluminum. Polyethylene dielectric and PVC jacket. Reel put-up. 

Order #	Carol ID	Rating	Length	Color	ONLY
24-10610	C5785	CM	500'	Black	\$44.49
24-10611	C5785	CM	1000'	Black	88.99
24-10612	C5889	CMR	500'	Black	48.49
24-10613	C5889	CMR	1000'	Black	94.99
24-10614	C3525	CMP	500'	Black	232.00
24-10615	C3525	CMP	1000'	Black	454.00

CAROL BRAND RG-59/U

NEW!

RG59/U coaxial cable 20AWG solid bare copper 10.1 Ω/Mft (CM) or copper clad steel 45.9 Ω/Mft (CMP). 95% bare copper braid. Dielectric is foam PE in a black PVC jacket (CM) or Fluoropolymer in a natural Flexguard PVC jacket (CMP). 

Order #	Carol ID	Rating	Length	Put-up	ONLY
24-10620	C1142	CM	500'	Pullbox	\$96.99
24-10621	C1142	CM	1000'	Pullbox	191.00
24-10622	C3500	CMP	500'	Reel	201.00
24-10623	C3500	CMP	1000'	Reel	403.00

Mini Coax

MCM

1000' Miniature 75ohm Black Coaxial Cable

Commonly used in crowded surveillance system racks. 24AWG bare copper center conductor with foam dielectric, 60% copper braid and PVC jacket. OD is 0.145" nominal. Swept tested to 2200MHz. Limited quantities. 

Order #	ONLY
24-8590	\$469.00

Stellar Labs™

500' Miniature Bundled Coax Cable

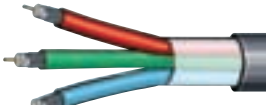
Ultra-flex mini RGB and RGBHV riser rated 75ohm precision video cable suitable for longer, in-wall component video and AV runs. Individual mini coax conductors are 23AWG solid bare copper for exceptional signal distance and frequency response. **Specifications:** •Swept tested to 2250MHz •23AWG solid bare copper conductors •Gas-injected FHDPE insulation •100% bonded aluminum foil and 95% aluminum braid shielding •PVC outer jacket •UL 1666; CMR rated; FT4 •RoHS compliant •3-conductor (RGB) 

Order #	ONLY
24-10295	\$282.00

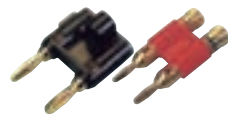

See audio connectors on page 185.

WIRE & CABLE



Section 10

Speaker Wire

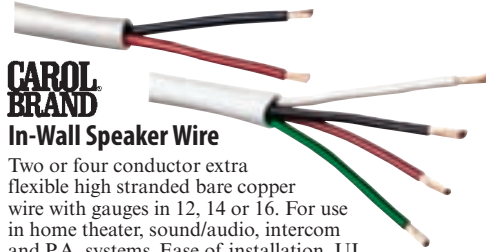

CAROL BRAND In-Wall Speaker Wire

Two or four conductor extra flexible high stranded bare copper wire with gauges in 12, 14 or 16. For use in home theater, sound/audio, intercom and P.A. systems. Ease of installation. UL Type CM and/or CL3. NEC Article 725. White PVC ripcord jacket. 

Order #	Carol ID	Gauge	Length	ONLY
Two Conductor				
24-10670	I162SSA65.B3.02	16	500'	\$121.00
24-10671	I162SSA65.B4.02	16	1000'	238.00
24-10674	I142SSA41.B3.02	14	500'	171.00
24-10675	I142SSA41.B4.02	14	1000'	313.00
24-10678	I122SSA105.38.02	12	500'	262.00
24-10679	I122SSA105.41.02	12	1000'	525.00
Four Conductor				
24-10672	I164SSA65.B3.02	16	500'	222.00
24-10673	I164SSA65.B4.02	16	1000'	434.00
24-10676	I144SSA41.B3.02	14	500'	292.00
24-10677	I144SSA41.B4.02	14	1000'	585.00
24-10680	I124SSA105.38.02	12	500'	504.00
24-10681	I124SSA105.41.02	12	1000'	1000.00

BELDEN

1189A Quad Shield RG-6/U

18AWG, solid bare copper covered steel center conductor, foam polyethylene dielectric, bonded aluminum foil (Bonded Duofoil) shield plus aluminum braid shield with 60% shield coverage plus aluminum foil (Duofoil) shield plus aluminum braid shield with 40% shield coverage and jacket. UL/NEC/CEC Rating: CATV or CM. Swept tested from 5MHz-1GHz, 20dB min. Outer diameter: 0.2980 nominal. 

Order #	Color	Length	(ea.)	(2-4)	(5-up)
24-7150	Black	1000'	\$149.00	\$142.00	\$140.00
24-7155	Black	500'	82.99	78.26	76.51
24-7160	White	1000'	182.00	177.00	173.00
24-7165	White	500'	95.99	93.21	93.21



CL3 Rated In-Wall Speaker Wire

Commercial grade, riser rated speaker wire features ultra flexible, high-conductivity ETP bare copper conductors with PVC insulation. Suitable for sound/audio, intercom/PA systems and security systems. Gray PVC jacket includes rip cord and sequential footage every 2'. •Black and red color for two conductor wire •Black, red, white and green for four conductor wire •UL1666 and CMR/CL3R in-wall rated. 

Order #	Description	Strand	Belden Series	Length (ea.)	(2-4)
2 Conductor					
24-9980	18AWG/ pull box	7 x 26	5300	500'	\$75.99 \$70.00
24-9985	18AWG/ pull box	7 x 26	5300	1000'	157.00 151.00
24-9990	16AWG/ pull box	19 x 29	5200	500'	133.00 127.00
24-9995	16AWG/ pull box	19 x 29	5200	1000'	231.00 218.00
24-10000	14AWG/ spool	19 x 29	5100	500'	196.00 184.00
24-10005	14AWG/ spool	19 x 29	5100	1000'	331.00 329.00
4 Conductor					
24-10010	16AWG/ pull box	19 x 29	5202	500'	211.00 208.00
24-10015	16AWG/ pull box	19 x 29	5202	1000'	408.00 388.00

BELDEN Coaxial Cable

Belden New Generation coaxial cable. UL type CM approval. Foam dielectric and black PVC jacket. Key: BC=Bare Copper, FB= Foil plus braid. 

Order #	Length	RG/U	Shield	(ea.)	(2-4)	(5-up)
Mfr. # 533985						
24-4990	1000'	6	BC/FB	\$189.00	\$182.00	\$179.00
Mfr. # 533945						
24-5000	1000'	6	BC/BC	213.00	209.00	206.00

RG-11 Coax Cables

NEW!

RG-11 PE Burial Solid Copper Coax

RG-11/U cable with 18AWG solid copper center conductor, 60% aluminum braid and 100% aluminum foil shield. **Features:** •SBCA compliant •UL CM rated •PVC jacket with 6.86 nominal O.D. •Dielectric: gas injected foam PE with 4.57mm O.D. •Swept tested to 3000MHz •Foot marking every 2' •Put-up: wooden spool. 

Fig.	Order #	Mfr. #	Length	(1-4)	(5-9)	(10-up)
A	24-11095	S1D60VV-B-R1K	1000'	\$199.00	\$186.00	\$182.00
B	24-11096	S1D60PN-O-R1K	1000'	199.00	186.00	182.00



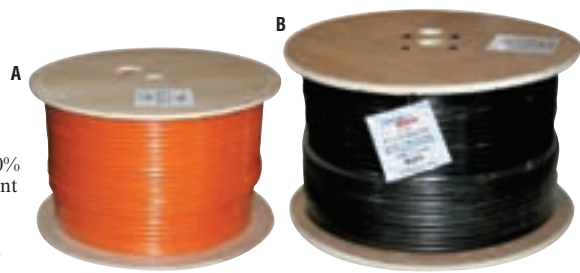

WIRE & CABLE

Section 10

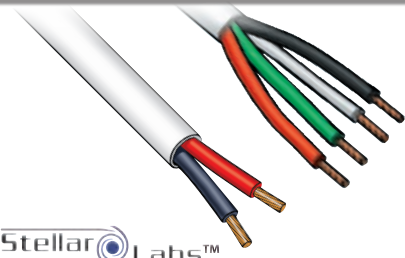

Stellar Labs™

CL2 Rated In-Wall Speaker Wire

Two and four conductor commercial grade in-wall CL2 rated speaker wire features 41-strand, high-conductivity ETP bare copper conductors with ultra flexible PVC insulation. **Features:** •Low capacitance, oxygen-free, high conductivity wire •White PVC outer jacket •Color-coded two and four conductor inner jacketed wire •UL CL2 rated •RoHS compliant •Reel-in-pull box put-up.

Order #	Description	Length	(1-3)	(4-8)
2 Conductor				
24-10325	18AWG	500'	\$69.99	-
24-10326	18AWG	1000'	131.00	-
24-10323	16AWG	500'	111.00	-
24-10324	16AWG	1000'	191.00	-
4 Conductor				
24-10322	18AWG	500'	111.00	\$96.00
24-10331	18AWG	1000'	201.00	182.00
24-10340	16AWG	500'	171.00	152.00
24-10341	16AWG	1000'	302.00	283.00

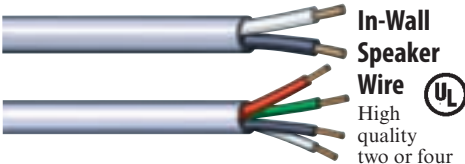

In-Wall Speaker Wire High quality two or four conductor wire for various audio applications. High flexibility allows for ease of installation through walls and around obstacles. Ideal for in-wall speakers and intercom systems. UL approved for in-wall use. Individual conductors in a common jacket for ease of installation. Color coded for quick identification.

High flexibility allows for ease of installation through walls and around obstacles. Ideal for in-wall speakers and intercom systems. UL approved for in-wall use. Individual conductors in a common jacket for ease of installation. Color coded for quick identification.

Order #	Gauge	Length	(ea.)	(2-4)	(5-up)
Two Conductor					
24-1645	14	100'	\$54.99	\$49.40	\$46.31
24-1650	14	500'	236.00	216.00	199.00
24-1655	16	100'	37.49	35.18	34.07
24-1660	16	500'	162.00	149.00	138.00
24-1665	18	100'	27.99	24.67	22.61
24-1670	18	500'	118.00	107.00	99.00
Four Conductor					
24-1675	14	100'	98.99	90.61	84.43
24-1685	16	100'	41.49	39.10	37.85
24-1690	16	500'	238.00	226.00	218.00
24-1695	18	100'	30.99	29.31	28.38
24-1700	18	500'	199.00	183.00	168.00



BELDEN Paired Audio Cable

1 twisted pair stranded (7 x 30) 22AWG tinned copper conductors. Polypropylene insulation. Beldfoil shield with 22AWG tinned copper drain wire providing 100% shield. PVC jacket is riser rated. 1000'. Mfr. #8451.

Order #	(ea.)	(2-4)	(5-up)
24-7175	\$254.00	\$224.00	\$219.00



Premium Speaker Wire

•Finely stranded, oxygen free copper conductors cabled in a ropelay design to increase the conductive surface, reduce skin effect and insure maximum flexibility
•Superflex extra soft, 60°C clear PVC insulation
•Extremely low capacitance, resistance and inductance of these cables transfer music signals from amplifier to speakers with high clarity and definition •Surface printed for identification and polarity •Made in USA

16 Gauge

•105 strands of 36 gauge copper

Order #	Length	(ea.)	(2-4)	(5-up)
24-1055	30'	\$20.99	\$19.52	\$18.91
24-1060	50'	23.99	22.46	21.75
24-1115	100'	41.49	36.01	33.95
24-1120	250'	96.99	88.55	81.34

12 Gauge

•259 strands of 36 gauge copper wire

Order #	Length	(ea.)	(2-4)	(5-up)
24-1070	50'	\$41.49	\$36.41	\$33.90
24-1125	100'	65.99	62.58	60.61
24-1130	250'	202.00	185.00	172.00

10 Gauge

•413 strands of 36 gauge copper wire

Order #	Length	(ea.)	(2-4)	(5-up)
24-1140	50'	\$51.99	\$48.88	\$47.34
24-1145	100'	92.99	88.03	85.24
24-1150	250'	227.00	215.00	208.00



Taperwire

18AWG/16' Taperwire Kit

Taperwire is designed for applications where standard wire runs are difficult. Taperwire can be concealed behind wall coverings like wall paper, and joint compound for painting. These kits come complete with wire and connectors to transition from standard wire.

These kits come complete with wire and connectors to transition from standard wire.

Order #	Mfr. #	(1-9 kits)	(10 kits-up)
50-1520	218MAT-16	\$46.49	\$42.64

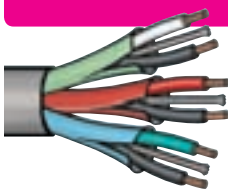

BELDEN

Shielded Audio, Control and Instrumentation Cable

Three twisted pairs, 22AWG stranded tinned copper conductors. Polypropylene insulation and chrome PVC jacket. Individual aluminum foil tape shielded pairs with a 22AWG stranded tinned copper drain wire provide 100% shield coverage.

Order #	Mfr. #	Length	(ea.)	(2-4)	(5-up)
24-7415	8777	1000'	\$738.00	\$715.00	\$700.00
24-7420	8777	500'	398.00	385.00	377.00



BELDEN

Shielded Audio, Control and Instrumentation Cable

Four conductor, 18AWG stranded tinned copper conductors with PVC insulation and chrome PVC jacket. Aluminum foil tape shield provides 100% shield coverage.

Order #	Mfr. #	Length	(ea.)	(2-4)	(5-up)
24-7385	9418	1000'	\$698.00	\$669.00	\$648.00
24-7390	9418	500'	327.00	318.00	313.00

Speaker Wire



Standard Speaker Wire

•Two conductor clear insulation, polarity identified by white stripe •Made in USA

Order #	Gauge	Length	ONLY
24-310	24	50'	\$6.05
24-320	24	500'	30.49
24-330	24	1000'	56.99
24-340	18	50'	8.07
24-350	18	500'	68.99
24-360	18	1000'	136.00
24-370	16	50'	13.49
24-380	16	500'	95.99
24-390	16	1000'	181.00
24-110	12	50'	33.49
24-120	12	100'	50.49
24-130	12	500'	313.00



Stereo Audio Cable

Make custom audio cables with this dual audio cable. Shielded to eliminate external hum and interference. 26AWG finely stranded oxygen-free copper conductors individually PCV insulated (red/white) and shielded with 28 strands of spiral-wound bare copper encased in a black PVC jacket.

Order #	Length	(1-9)	(10-49)	(50-up)
24-2575	50'	\$8.47	\$7.66	\$6.80
24-2580	100'	19.99	17.46	14.31



High Resolution Audio Cable

For custom made interconnects between audio/video components, MCM offers high resolution cable to meet your home theater needs. This cable is 100% shielded with a center insulator for optimum performance. To be used with our gold plated RCA connectors. Cable size 6mm.

Order #	Length	(1-9)	(10-up)
50-2170	25'	\$13.49	\$12.21
50-2175	50'	23.99	22.10
50-2180	100'	46.99	44.14

Audio Control



BELDEN

Unshielded Audio, Control and Instrumentation Cable

One twisted pair, stranded tinned copper conductors. PVC insulation and chrome PVC jacket. 9740 is high strand count for added cable flexibility.

Order #	Mfr. #	AWG	Length	(ea.)	(2-4)	(5-up)
24-7430	8442	22	500'	\$121.00	\$116.00	\$114.00
24-7535	8205	20	1000'	255.00	246.00	241.00
24-7480	9740	18	500'	219.00	213.00	210.00
24-7405	8471	16	1000'	799.00	778.00	760.00

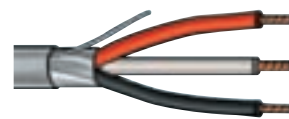

BELDEN

Shielded Triad Audio, Control and Instrumentation Cable

One triad, three conductors, stranded tinned copper conductors with polyethylene insulation. Aluminum foil tape and 20AWG tinned copper drain wire provide 100% shield coverage. CM rated chrome PVC jacket.

Order #	Mfr. #	AWG	Length	(ea.)	(2-4)	(5-up)
24-7360	8770	18	500'	\$346.00	\$341.00	\$334.00
24-7485	8771	22	1000'	361.00	342.00	331.00
24-7490	8771	22	500'	170.00	161.00	159.00

Special Purpose Wire

Rotator Cable

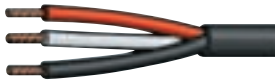
Three conductor cable for use with many popular antenna rotators. Outer jacket 0.162" black PVC with 0.020" wall. Three 20AWG conductors color coded black, white and red. 

Order #	Length	(ea.)	(2-4)	(5-up)
24-3080	100'	\$30.49	\$23.02	\$21.43
24-3085	500'	131.00	106.00	98.00
24-3090	1000'	232.00	190.00	175.00

Enamel Magnet Wire

•Used for making custom coils, transformers, etc. •Copper wire with enamel insulation •Temperature range: -30°~80°C •Sold in ¼ lb. spools 

Order #	Gauge	Approximate Length			
		(ea.)	(2-4)	(5-up)	
24-825	30	770'	\$10.49	\$9.18	\$8.33
24-828	28	500'	8.98	8.46	7.77
24-830	26	300'	10.99	9.46	8.46
24-833	24	200'	8.27	7.48	6.77
24-835	22	125'	9.60	8.75	7.90
24-838	20	75'	8.27	7.48	6.77
24-840	18	50'	8.27	7.26	6.58
24-843	16	30'	16.99	13.72	12.33

Standard Lamp Wire

•2 conductor: One bare copper, one tinned copper •18 gauge standard •1 conductor ribbed for polarity identification •300V suggested working voltage •Brown jacket •SPT-1 •Made in USA 

Order #	Length	(ea.)	(2-4)	(5-up)
24-570	50'	\$13.49	\$10.04	\$8.99
24-580	500'	101.00	84.00	77.00

BELDEN Sound and Control Cable

Paired 18AWG stranded, tinned copper conductors (16 x 30) and chrome PVC jacket. 8760 features overall Beldfoil shield with 20AWG drain wire. 

Order #	Mfr. #	Pair/AWG	Length	(ea.)	(2-4)	(5-up)
24-5050	8760	1/18 1000'	\$382.00	\$376.00	\$371.00	
24-5055	8760	1/18 500'	204.00	192.00	186.00	
24-5085	8690	3/18 500'	518.00	516.00	512.00	

BELDEN Shielded Audio Control and Instrumentation Cable

One twisted pair, stranded tinned copper. Polyethylene insulation, aluminum foil tape and 22AWG tinned copper drain wire provide 100% shield coverage. CM rated chrome PVC jacket. 

Order #	Mfr. #	AWG	Length	(ea.)	(2-4)	(5-up)
24-7345	8761	22	1000'	\$300.00	\$296.00	\$287.00
24-7350	8761	22	500'	146.00	139.00	137.00
24-7380	8762	20	500'	239.00	227.00	220.00
24-7400	8719	16	500'	452.00	437.00	428.00

BELDEN Brilliance® Professional Music/ Microphone Cable

Designed for flexibility, service and reliable signal transmission at audio frequencies. Shielded single conductor cable is used in high impedance systems and multi-conductor cable is used in low impedance applications. Rubber jacketed cable for abrasion and impact resistance, allows cable to lie flat. Tinned cadmium bronze conductors, rubber insulated and tinned copper braid shield. 100'. 

Order #	Type	AWG	Cond.	ONLY
36F026WA	8413	24	2	\$159.00

BELDEN Paired Audio and Control Cable

One twisted pair, 22AWG stranded, tinned copper conductors. Polypropylene insulation, foil tape with 22AWG stranded, tinned copper drain wire providing 100% shield coverage. Gray PVC jacket. 

Order #	Mfr. #	Length	(ea.)	(2-4)	(5-up)
24-7605	9451	1000'	\$223.00	\$209.00	\$205.00
24-7610	9451	500'	138.00	133.00	130.00

WIRE & CABLE

Section
10



NTE 25' Stranded Hook-Up Wire

Stranded hook-up wire for point-to-point wiring. Ideal for wiring of electrical and electronic equipment, meters, computers, business machines, appliances and control panels. **Specifications:** •Gauges: 26-24-22-20-18 •Rated for 300V •UL style 1007 •CSA TR-64/1569 •Passes UL VW-1.S vertical flame test •OSHA acceptable •Stranded tinned copper (strand count 22, 24, 26 gauge = 7 strand; 20 gauge = 10 strand; 18 gauge = 16 strand)

Also available in 100' put-ups visit www.MCMelectronics.com

Order #	Color	(1-4)	(5-9)
18AWG			
24-10350	Black	\$6.89	\$6.54
24-10351	Brown	6.89	6.54
24-10352	Red	6.89	6.54
24-10353	Orange	6.89	6.54
24-10354	Yellow	6.89	6.54
24-10355	Green	6.89	6.54
24-10356	Blue	6.89	6.54
24-10357	Violet	6.89	6.54
24-10358	Gray	6.89	6.54
24-10359	White	6.89	6.54
20AWG			
24-10370	Black	5.79	5.45
24-10371	Brown	5.79	5.45
22AWG			
24-10372	Red	\$5.79	\$5.45
24-10373	Orange	6.79	6.40
24-10374	Yellow	5.79	5.45
24-10375	Green	5.79	5.45
24-10376	Blue	5.79	5.45
24-10377	Violet	5.79	5.45
24-10378	Gray	5.79	5.45
24-10379	White	5.79	5.45
24AWG			
24-10390	Black	4.59	4.36
24-10391	Brown	4.59	4.36
24-10392	Red	4.59	4.36
24-10393	Orange	4.59	4.36
24-10394	Yellow	4.59	4.36

Order #	Color	(1-4)	(5-9)
24-10395	Green	\$4.59	\$4.36
24-10396	Blue	4.59	4.36
24-10397	Violet	4.59	4.36
24-10398	Gray	4.59	4.36
24-10399	White	4.59	4.36
26AWG			
24-10418	Gray	\$4.59	\$4.36
24-10419	White	4.59	4.36
26AWG			
24-10430	Black	3.49	3.27
24-10431	Brown	3.49	3.27
24-10432	Red	3.49	3.27
24-10433	Orange	3.49	3.27
24-10434	Yellow	3.49	3.27
24-10435	Green	3.49	3.27
24-10436	Blue	3.49	3.27
24-10437	Violet	3.49	3.27
24-10438	Gray	3.49	3.27
24-10439	White	3.49	3.27

Kynar Wire

Kynar wire commonly used for wire wrap projects. 30 gauge solid wire in various colors to ease circuit identification. 

Order #	Description	(ea.)	(2-4)	(5-up)
24-1805	25' red	\$6.86	\$5.65	\$4.22
24-1810	50' red	11.49	9.88	8.46
24-1820	50' black	11.49	9.88	8.46
24-1830	50' green	11.49	9.88	8.46
24-1845	25' yellow	6.86	5.65	4.22
24-1850	50' yellow	11.49	9.88	8.46
24-1855	25' white	6.86	5.48	4.10
24-1860	50' white	11.49	9.88	8.46

Test Lead Wire

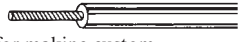
Rubber/PVC test lead wire for making custom probe leads or clip leads. 18 gauge stranded conductor (65 gauge x 36 strands). Insulation thickness .045, outside diameter .140. Working voltage 5000V. Construction resists oils, acids and solvents. UL listed. 50' length. 

Order #	Description	(ea.)	(2-4)	(5-up)
24-1795	50' 18 gauge, red	\$15.49	\$15.11	\$14.22
24-1800	50' 18 gauge, black	15.49	15.11	14.22

Audio Control

BELDEN Sound and Control Cable

Paired 18AWG stranded, tinned copper conductors (16 x 30) and chrome PVC jacket. 8760 features overall Beldfoil shield with 20AWG drain wire. 

Order #	Mfr. #	Pair/AWG	Length	(ea.)	(2-4)	(5-up)
24-5050	8760	1/18 1000'	\$382.00	\$376.00	\$371.00	
24-5055	8760	1/18 500'	204.00	192.00	186.00	
24-5085	8690	3/18 500'	518.00	516.00	512.00	

BELDEN Shielded Audio Control and Instrumentation Cable

One twisted pair, stranded tinned copper. Polyethylene insulation, aluminum foil tape and 22AWG tinned copper drain wire provide 100% shield coverage. CM rated chrome PVC jacket. 

Order #	Mfr. #	AWG	Length	(ea.)	(2-4)	(5-up)
24-7345	8761	22	1000'	\$300.00	\$296.00	\$287.00
24-7350	8761	22	500'	146.00	139.00	137.00
24-7380	8762	20	500'	239.00	227.00	220.00
24-7400	8719	16	500'	452.00	437.00	428.00

BELDEN Brilliance® Professional Music/ Microphone Cable

Designed for flexibility, service and reliable signal transmission at audio frequencies. Shielded single conductor cable is used in high impedance systems and multi-conductor cable is used in low impedance applications. Rubber jacketed cable for abrasion and impact resistance, allows cable to lie flat. Tinned cadmium bronze conductors, rubber insulated and tinned copper braid shield. 100'. 

Order #	Type	AWG	Cond.	ONLY
36F026WA	8413	24	2	\$159.00

BELDEN Paired Audio and Control Cable

One twisted pair, 22AWG stranded, tinned copper conductors. Polypropylene insulation, foil tape with 22AWG stranded, tinned copper drain wire providing 100% shield coverage. Gray PVC jacket. 

Order #	Mfr. #	Length	(ea.)	(2-4)	(5-up)
24-7605	9451	1000'	\$223.00	\$209.00	\$205.00
24-7610	9451	500'	138.00	133.00	130.00

BELDEN Microphone Cable

Brilliance, 99.95% pure high conductivity copper, two conductor low impedance cables. 20AWG, two conductor stranded (26 x 34) tinned copper conductors, copper braid shield. Black rubber jacket for greater abrasion and impact resistance and extra limpness so the cable will lie flat on stage or on studio floors. Mfr. #8412. 

Order #	Length	(ea.)	(2-4)	(5-up)
24-5095	500'	\$551.00	\$537.00	\$526.00

Superior Quality Microphone Cable

•2 conductor with braided shield •PVC jacket •For use with low impedance microphones •22 gauge conductors •Nominal capacitance 31pF •.235" (O.D.) •Made in USA 

Order #	Length	(ea.)	(2-4)	(5-up)
24-441	100'	\$50.49	\$44.25	\$41.16
24-440	500'	222.00	192.00	178.00





WIRE & CABLE

Section 10

CAROL BRAND Multiconductor Unshielded Cable (CMR Riser)

Solid or stranded bare copper wire in 2, 3, 4, 6, 8 conductor, ASTM B-3, B-8 and B-286. Gray PVC jacket with sequential footage marking for installation ease. Available in 12, 14, 16, 18, 20 or 22 AWG. Application: power limited control circuits for intercom, security, audio and background music. Suggested voltage rating 300 volts. Compliances: NEC Article 725 type CL3R (UL: 75C, 150V) and NEC Article 800 type CMR (UL: 75C, 300V).

Order #	Carol ID	No. Cond.	Lgth.	OD	(1-3)	(4-up)
22 AWG, solid strand						
24-10685	E1000S	2	500'	.118	\$32.49	\$29.71
24-10686	E1000S	2	1000'	.118	63.99	59.41
24-10687	E1001S	4	500'	.126	66.99	63.62
24-10688	E1001S	4	1000'	.126	104.00	96.00
22 AWG, 7/30 strands						
24-10689	E1002S	2	500'	.122	34.49	32.06
24-10690	E1002S	2	1000'	.122	68.99	64.16
24-10691	E1004S	4	500'	.141	58.99	54.48
24-10692	E1004S	4	1000'	.141	118.00	109.00
24-10693	E1006S	6	500'	.164	82.99	76.87
24-10694	E1006S	6	1000'	.164	165.00	154.00
24-10695	E1008S	8	500'	.180	109.00	102.00
24-10696	E1008S	8	1000'	.180	217.00	203.00
20 AWG, 7/28 strands						
24-10697	E1022S	2	500'	.134	95.99	88.85
24-10698	E1024S	4	1000'	.142	81.99	75.77
24-10699	E1024S	4	1000'	.142	163.00	152.00
18 AWG, 7/26 strands						
24-10700	E1032S	2	500'	.156	62.99	57.76
24-10701	E1032S	2	1000'	.156	125.00	116.00
24-10702	E1033S	3	500'	.166	87.99	81.70
24-10703	E1033S	3	1000'	.166	175.00	164.00
24-10704	E1034S	4	500'	.187	114.00	106.00
24-10705	E1034S	4	1000'	.187	226.00	211.00
16 AWG, 19/0117 strands						
24-10706	E1042S	2	500'	.178	94.99	88.27
24-10707	E1042S	2	1000'	.178	189.00	177.00
24-10708	E1044S	4	500'	.210	161.00	153.00
24-10709	E1044S	4	1000'	.210	322.00	306.00
14 AWG, 19/0147 strands						
24-10710	E1052S	2	500'	.224	122.00	113.00
24-10711	E1052S	2	1000'	.224	242.00	226.00
24-10712	E1054S	4	500'	.264	306.00	290.00
24-10713	E1054S	4	1000'	.264	611.00	580.00
12 AWG, 19/0185 strands						
24-10714	E1062S	2	500'	.260	195.00	182.00
24-10715	E1062S	2	1000'	.260	390.00	364.00



Terminal Strips

•10A current rating •Made of black thermoplastic

Order #	Terminals	Length	ONLY
28-710	4	2"	\$1.71
28-715	8	3"	2.21
28-720	12	5"	2.62
28-725	16	6"	2.72
28-730	20	8"	3.83

See more connectors on pages 196 and 197.

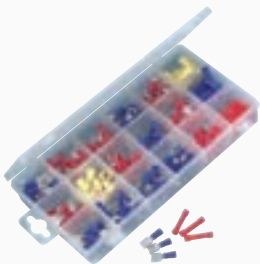

Solderless Terminal Kits

175 piece solderless terminal kits contains a complete assortment of insulated ring, spade, butt and disconnects.

Order #	ONLY
28-6295	\$9.28

Multi-Conductor Wire

**CAROL BRAND****NEW!**

Multiconductor Shielded Cable (CMR Riser)

Solid or stranded bare copper wire in 2, 3, 4, 6, 8 conductor, ASTM B-3, B-8 and B-286. Gray PVC jacket with sequential footage marking for installation ease. Shield: Overall polyester supported aluminum foil with stranded tinned copper drain wire. Available in 12, 14, 16, 18, 20 or 22 AWG. Application: power limited control circuits for intercom, security, audio and background music. Suggested voltage rating 300 volts. Compliances: NEC Article 725 type CL3R (UL: 75C, 150V) and NEC Article 800 type CMR (UL: 75C, 300V).

Order #	Carol ID	No. Cond.	Lgth.	OD	(1-3)	(4-up)
22 AWG, solid strand						
24-10716	E2000S	2	500'	.117	\$43.49	\$39.95
24-10717	E2000S	2	1000'	.117	85.99	79.89
22 AWG, 7/30 strands						
24-10718	E2002S	2	500'	.132	50.49	46.52
24-10719	E2002S	2	1000'	.132	99.99	93.05
24-10720	E2004S	4	500'	.147	79.99	74.53
24-10721	E2004S	4	1000'	.147	160.00	150.00
24-10722	E2006S	6	500'	.173	105.00	97.00
24-10723	E2006S	6	1000'	.173	209.00	194.00
24-10724	E2008S	8	500'	.195	121.00	113.00
24-10725	E2008S	8	1000'	.195	241.00	225.00
20 AWG, 7/28 strands						
24-10726	E2022S	2	500'	.142	64.99	59.82
24-10727	E2022S	2	1000'	.142	129.00	120.00
20 AWG, 7/28 strands						
24-10728	E2024S	4	500'	.171	97.99	91.21
24-10729	E2024S	4	1000'	.171	196.00	183.00
18 AWG, 7/26 strands						
24-10730	E2032S	2	500'	.164	84.99	79.02
24-10731	E2032S	2	1000'	.164	170.00	159.00
24-10732	E2033S	3	500'	.172	108.00	100.00
24-10733	E2033S	3	1000'	.172	214.00	199.00
24-10734	E2034S	4	500'	.187	132.00	123.00
24-10735	E2034S	4	1000'	.187	262.00	245.00
16 AWG, 19/0117 strands						
24-10736	E2042S	2	500'	.189	94.99	88.24
24-10737	E2042S	2	1000'	.189	189.00	177.00
24-10738	E2044S	4	1000'	.219	379.00	354.00
14 AWG, 19/0147 strands						
24-10739	E2052S	2	500'	.245	169.00	158.00
24-10740	E2052S	2	1000'	.245	337.00	315.00
24-10741	E2054S	4	1000'	.269	755.00	706.00
12 AWG, 19/0185 strands						
24-10742	E2062S	2	500'	.281	247.00	231.00
24-10743	E2062S	2	1000'	.281	493.00	461.00



CAROL BRAND Multiconductor Unshielded Cable Plenum (FPLR)

Annealed solid bare copper wire in two or four conductor, ASTM B-3. Red PVC jacket. Available in 12, 14, 16, or 18 AWG. Application: fire and burglar alarms, smoke detectors, voice communication, and fire protective circuits. Suggested voltage rating 300V. Compliances: NEC Article 760 type FPLR (UL: 75C, 300V), NFPA 262 and CSA FT-6 Steiner Tunnel Fire Tests for Plenum applications.

Order #	Carol ID	No. Cond.	Lgth.	OD	(1-3)	(4-up)
18 AWG, solid strand						
24-10830	E3502S	2	500'	.155	\$71.99	\$66.50
24-10831	E3502S	2	1000'	.155	143.00	133.00
24-10832	E3504S	4	500'	.175	134.00	124.00
24-10833	E3504S	4	1000'	.175	266.00	248.00
16 AWG, solid strand						
24-10834	E3512S	2	500'	.172	134.00	124.00
24-10835	E3512S	2	1000'	.172	266.00	248.00
24-10836	E3514S	4	500'	.202	189.00	177.00
24-10837	E3514S	4	1000'	.202	378.00	354.00
14 AWG, solid strand						
24-10838	E3522S	2	500'	.205	129.00	120.00
24-10839	E3522S	2	1000'	.205	256.00	239.00
24-10840	E3524S	4	500'	.243	282.00	264.00
24-10841	E3524S	4	1000'	.243	564.00	527.00
12 AWG, solid strand						
24-10842	E3532S	2	500'	.244	213.00	198.00
24-10843	E3532S	2	1000'	.244	424.00	396.00



CAROL BRAND Mid-Capacitance, Shielded Cable Non-Plenum (FPL)

Annealed solid bare copper wire ASTM B-3. Red PVC jacket. Application: Addressable fire alarms systems, smoke detectors, voice communication, and pull boxes. Suggested voltage rating 300V. Compliances: NEC Article 760 type FPL (UL: 60C, 300V) and passes UL 70,000 BTU vertical tray flame test.

Order #	Carol ID	No. Cond.	Lgth.	OD	(1-3)	(4-up)
18 AWG, solid strand						
24-10861	E3502S	2	1000'	.182	\$226.00	\$211.00



CAROL BRAND Multiconductor Shielded Cable Non-Plenum (FPLR)

Annealed solid bare copper wire in two or four conductor, ASTM B-3. Red PVC jacket. Available in 12, 14, 16, or 18 AWG. Shield: Overall polyester supported aluminum foil with stranded tinned copper drain wire. Application: Fire, burglar, and smoke alarms, voice communication, and fire protective circuits. Suggested voltage rating 300V. Compliances: NEC Article 760 type FPLR (UL: 75C, 300V) and UL 1666 flame test.

Order #	Carol ID	No. Cond.	Lgth.	OD	(1-3)	(4-up)
18 AWG, solid strand						
24-10815	E2502S	2	500'	.158	\$71.99	\$66.50
24-10816	E2502S	2	1000'	.158	143.00	133.00
24-10817	E2504S	4	500'	.183	130.00	121.00
24-10818	E2504S	4	1000'	.183	259.00	242.00
16 AWG, solid strand						
24-10819	E2522S	2	500'	.180	105.00	98.00
24-10820	E2522S	2	1000'	.180	209.00	195.00
24-10821	E2524S	4	500'	.210	171.00	159.00
24-10822	E2524S	4	1000'	.210	341.00	318.00
14 AWG, solid strand						
24-10823	E2532S	2	500'	.218	145.00	135.00
24-10824	E2532S	2	1000'	.218	288.00	269.00
24-10825	E2534S	4	500'	.253	276.00	258.00
24-10826	E2534S	4	1000'	.253	552.00	515.00
12 AWG, solid strand						
24-10827	E2542S	2	500'	.252	223.00	208.00
24-10828	E2542S	2	1000'	.252	445.00	416.00



CAROL BRAND Multiconductor Unshielded Cable Non-Plenum (FPLR)

Annealed solid bare copper wire in 2 or 4 conductor, ASTM B-3. Red PVC jacket. Available in 12, 14, 16, or 18 AWG. Application: fire and burglar alarms, smoke detectors, voice communication, and fire protective circuits. Suggested voltage rating 300 volts. Compliances: NEC Article 760 type FPLR (UL: 75C, 300V) and UL 1666 flame test.

Order #	Carol ID	No. Cond.	Lgth.	OD	(1-3)	(4-up)
18 AWG, solid strand						
24-10800	E1502S	2	500'	.150	\$53.99	\$49.96
24-10801	E1502S	2	1000'	.150	108.00	100.00
24-10802	E1504S	4	500'	.175	96.99	90.46
24-10803	E1504S	4	1000'	.175	194.00	181.00
16 AWG, solid strand						
24-10804	E1512S	2	500'	.172	78.99	72.75
24-10805	E1512S	2	1000'	.172	156.00	146.00
24-10806	E1514S	4	500'	.202	151.00	141.00
24-10807	E1514S	4	1000'	.202	301.00	282.00
14 AWG, solid strand						
24-10808	E1522S	2	500'	.210	110.00	102.00
24-10809	E1522S	2	1000'	.210	219.00	204.00
24-10810	E1524S	4	500'	.248	233.00	217.00
24-10811	E1524S	4	1000'	.248	464.00	434.00
12 AWG, solid strand						
24-10812	E1532S	2	500'	.244	185.00	173.00
24-10813	E1532S	2	1000'	.244	369.00	345.00

Multi-Conductor Wire



NEW!

CAROL BRAND Multiconductor Unshielded Cable Plenum (CMP)

Solid or stranded bare copper wire in 2, 3, 4, 6, 8 conductor, ASTM B-3, B-8 and B-286. Natural PVC jacket with sequential footage marking for installation ease. Available in 12, 14, 16, 18, 20 or 22 AWG. Application: power limited control circuits for intercom, security, audio and background music. Suggested voltage rating 300 volts. Compliances: NEC Article 725 type CL3P (UL: 75C, 150V) and NEC Article 800 type CMP (UL: 75C, 300V).

Order #	Carol ID	No. Cond.	Lgth.	OD	(1-3)	(4-up)
22 AWG, solid strand						
24-10745	E3000S	2	500'	.108	\$41.49	\$39.33
24-10746	E3000S	2	1000'	.108	82.99	78.67
24-10747	E3001S	4	500'	.124	61.99	56.91
24-10748	E3001S	4	1000'	.124	123.00	114.00
22 AWG, 7/30 strands						
24-10749	E3002S	2	500'	.120	47.49	43.82
24-10750	E3002S	2	1000'	.120	93.99	87.64
24-10751	E3004S	4	500'	.139	77.99	72.22
24-10752	E3004S	4	1000'	.139	155.00	145.00
24-10753	E3006S	6	500'	.164	202.00	189.00
24-10754	E3008S	8	500'	.178	149.00	139.00
24-10755	E3008S	8	1000'	.178	297.00	278.00
20 AWG, 7/28 strands						
24-10756	E3022S	2	1000'	.138	98.99	92.23
24-10757	E3024S	4	1000'	.161	198.00	185.00
18 AWG, 7/26 strands						
24-10758	E3032S	2	500'	.156	78.99	73.23
24-10759	E3032S	2	1000'	.156	157.00	147.00
24-10760	E3033S	3	1000'	.166	223.00	207.00
24-10761	E3034S	4	500'	.187	138.00	129.00
24-10762	E3034S	4	1000'	.187	275.00	257.00
16 AWG, 19/0117 strands						
24-10763	E3042S	2	500'	.174	113.00	105.00
24-10764	E3042S	2	1000'	.174	224.00	209.00
24-10766	E3044S	4	1000'	.205	403.00	377.00
14 AWG, 19/0147 strands						
24-10767	E3052S	2	1000'	.216	329.00	307.00
24-10768	E3054S	4	1000'	.255	615.00	575.00
12 AWG, 19/0185 strands						
24-10769	E3062S	2	1000'	.252	496.00	463.00

Multi-Conductor Computer Wire

Computer Cables

•Multiconductor, 28 gauge stranded wire •PVC type insulation •Complete shielding reduces RF interference

Order #	Conductors	Length	(ea.)	(2-4)	(5-up)
83-0035	9	100'	\$53.49	\$46.22	\$41.60
83-0030	9	500'	240.00	221.00	209.00
83-0060	12	500'	300.00	279.00	256.00

BELDEN

Non Paired Computer Cable

Four conductor, 24AWG stranded, tinned copper conductors. Foil tape with 24AWG stranded tinned copper drain wire provides 100% shield coverage. PVC insulation and chrome PVC jacket.

Order #	Mfr. #	Length	(ea.)	(2-4)	(5-up)
24-7510	9534	500'	\$206.00	\$198.00	\$194.00



BELDEN

Multiconductor Computer Cable

Multiconductor computer cable for RS-232 applications. 15 conductor, 24AWG stranded conductors (7 x 32). Overall Beldfoil shield with 24AWG drain wire. Chrome PVC jacket. Mfr. #9541.

Order #	Length	(ea.)	(2-4)	(5-up)
24-5065	500'	\$546.00	\$529.00	\$518.00

BELDEN

Individually Shielded Paired Computer Cable

Tinned copper conductors. Black and red under Beldfoil® aluminum-polyester shield. Stranded tinned common drain wire. Chrome PVC jacket. Pairs cabled on common axis to reduce diameter. Capacitance 35 pF/ft. Belden type: 8723. Outside diameter: .165".

Order #	Length	(ea.)	(2-up)
36F1033WA	100'	\$42.49	\$41.27
36F1033WF	500'	211.00	204.00
36F1033WM	1000'	299.00	295.00

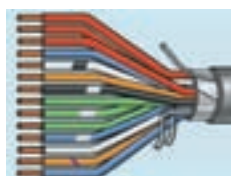

WIRE & CABLE



Section 10

BELDEN Unshielded Plenum Multi-Conductor

Belden New Generation unshielded plenum multi-conductor cable. UL, NEC, CMP approvals. Bare copper conductors. Natural Flammarrest jacket with ripcord. Applications: Security systems, intercom, PA systems, sound/ audio, power limited controls.

Order #	Length	Cond/ AWG	Color	(ea.)	(2-4)	(5-up)
Mfr. #6300UE						
24-4680	1000'	2/18	Gray	\$188.00	\$174.00	\$172.00
24-4685	500'	2/18	Gray	105.00	100.00	98.00
Mfr. #6302UE						
24-4725	500'	4/18	Natural	181.00	174.00	171.00

BELDEN Unshielded Riser Multi-Conductor

Belden New Generation riser alarm cable. UL, NEC approvals. Bare copper conductors. 5582UE is stranded, all others are solid. Gray PVC jacket with ripcord. Applications: Security systems, intercom/PA systems, sound/audio, power limited controls.

Order #	Mfr. #	Cond/ Length	AWG	(ea.)	(2-4)	(5-up)
24-4790	5582UE	1000'	4/22	\$162.00	\$158.00	\$154.00
24-4810	5500UE	1000'	2/22	87.99	83.64	81.91
24-4815	5500UE	500'	2/22	44.49	41.26	40.41

BELDEN Multi-Conductor Unshielded Cable

•Multiconductor unshielded control, audio and computer cable. •Tinned copper stranded cable, PVC insulation, chrome PVC jacket •Working voltage 600V

Order #	Type	Cond.	(O.D.)	(L)	(ea.)	(2-up)
22AWG						
36F040WF	8443	3	.172"	500'	\$197.00	\$191.00
36F041WF	8444	4	.185"	500'	227.00	220.00
37F3085WA	9421	8	.229"	100'	82.99	78.58
20AWG						
36F043WA	8446	6	.236"	100'	91.99	86.33
36F1086WA	9444	4	.217"	100'	69.99	64.73
37F3089WA	9439	7	.260"	100'	115.00	110.00
36F1089WA	9457	12	.338"	100'	85.99	69.54
18AWG						
36F1018WA	8467	7	.324"	100'	142.00	137.00
36F144WA	8466	12	.424"	100'	231.00	224.00
16AWG						
36F146WA	8620	4	.375"	100'	206.00	195.00
36F1095WA	9620	5	.405"	100'	229.00	222.00

BELDEN Twisted Pair Plenum Cable

Belden New Generation plenum cable. UL, NEC approvals. Bare copper stranded conductors. Shielded cables are Beldfoil shield applied overall with a drain wire. Natural Flammarrest jacket with ripcord. Applications: Broadcast, intercom/PA systems, sound/ audio, power limited controls.

Order #	Mfr. #	Length	Pair/ AWG	(ea.)	(2-4)	(5-up)
Shielded						
24-4870	6541FE	1000'	2/22	\$248.00	\$240.00	\$235.00
24-4875	6541FE	500'	2/22	142.00	137.00	134.00
Unshielded						
24-4895	6341UE	500'	2/18	227.00	219.00	214.00



Customer Service:
1-877-626-3532

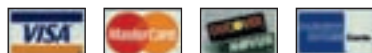



WIRE & CABLE

Section 10

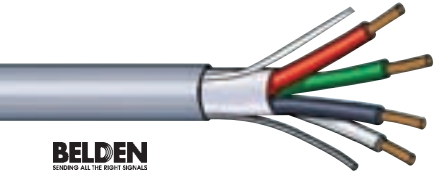

Multi-Conductor Wire

**BELDEN**

Shielded Riser Multi-Conductor Cable

New Generation, four conductor, 22AWG stranded bare copper conductors. PVC insulation, foil tape with 24AWG stranded tinned bare copper drain wire providing 100% shield coverage. Gray PVC jacket.

Common applications include: Broadcast, intercom/P.A. systems, sound/audio, power limited controls.

Order #	Mfr. #	Length	(1-2)	(3-9)	(10-24)
24-7700	5502FE	1000'	\$204.00	\$194.00	\$188.00
24-7705	5502FE	500'	109.00	101.00	98.00

**BELDEN**

Shielded Riser Multi-Conductor

Belden New Generation riser alarm cable. UL, NEC approvals. Bare copper stranded conductors. Beldfoil shield applied overall with a drain wire. Gray PVC jacket with ripcord. Applications: Security systems, broadcast, intercom/PA systems, sound/audio, power limited controls.

Order #	Mfr. #	Length	Cond/ AWG	(ea.)	(2-4)	(5-up)
24-4780	5300FE	1000'	2/18	\$196.00	\$191.00	\$191.00
24-4785	5300FE	500'	2/18	113.00	105.00	102.00
24-4830	5500FE	1000'	2/22	127.00	124.00	124.00
24-4835	5500FE	500'	2/22	61.99	56.81	56.02

**BELDEN**

Shielded Plenum Multi-Conductor

Belden New Generation shielded plenum multi-conductor cable. UL, NEC, CMP approvals. Bare copper conductors. Natural Flammarrest jacket with ripcord. Beldfoil shield applied overall (foil side out plus 20AWG drain wire). Applications: Alarm, security, broadcast, intercom/PA systems, sound and audio, power limited controls, background music, nurse call. Natural color.

Order #	Mfr. #	Length	Cond/ AWG	(ea.)	(2-4)	(5-up)
24-4670	6300FE	1000'	2/18	\$196.00	\$184.00	\$178.00
24-4675	6300FE	500'	2/18	99.99	93.34	92.03
24-4710	6500FE	1000'	2/22	122.00	119.00	115.00
24-4715	6500FE	500'	2/22	69.99	64.94	62.89
24-4750	6302FE	1000'	4/18	360.00	348.00	338.00
24-4755	6302FE	500'	4/18	194.00	187.00	185.00

Automotive Primary Wire

•Multi-stranded single conductor automotive primary wire •Soft bare electrolytic copper for maximum flexibility and conductivity •Made of a flame retardant compound that is highly resistant to oil, water, alkalis, ozone, grease and diesel fumes •Made in USA

Order #	Length	Color	(ea.)	(2-4)	(5-up)
16 Gauge-19 strands of 29 gauge copper wire					
24-1250	100'	Red	\$17.99	\$14.59	\$13.58
24-1255	100'	Black	17.99	14.59	13.58
24-1260	250'	Red	35.49	30.81	28.48
14 Gauge-19 strands of 27 gauge copper wire					
24-1275	50'	Black	14.49	11.60	10.81
24-1285	100'	Black	23.99	20.46	19.05
24-1290	250'	Red	53.99	47.54	43.96
12 Gauge-65 strands of 30 gauge copper wire					
24-1300	50'	Red	19.99	16.56	15.42
24-1305	50'	Black	19.99	16.56	15.42
24-1310	100'	Red	32.49	28.52	26.56
24-1315	100'	Black	32.49	28.52	26.56

Primary Wire



Automotive "Zip" Cord

Multi-stranded soft bare electronic copper conductors. Insulated with 80° "GPT" automotive grade VW-1 flame retardant PVC. (One conductor is all red and one conductor is all black (for polarity) in "zip cord" construction. Useful as "CB" power cord, stereo, alarm and other general purpose applications.

Order #	Length	(ea.)	(2-4)	(5-up)
18 Gauge				
24-1875	50'	\$14.49	\$13.66	\$12.97
24-1870	100'	25.99	24.41	23.20
24-1865	250'	65.99	56.61	53.52
16 Gauge				
24-1890	50'	18.99	17.56	16.69
24-1885	100'	33.49	31.27	29.70
24-1880	250'	78.99	67.48	64.10
14 Gauge				
24-1905	50'	25.99	24.41	23.20
24-1900	100'	45.49	43.01	40.85
24-1895	250'	116.00	99.00	94.00
12 Gauge				
24-1920	50'	36.49	34.20	32.49
24-1915	100'	62.99	59.65	56.67
24-1910	250'	161.00	136.00	129.00
10 Gauge				
24-1935	50'	49.49	46.92	44.58
24-1930	100'	85.99	81.18	77.12
24-1925	250'	201.00	176.00	167.00

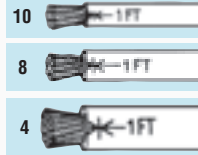

Primary Wire

•Multi-stranded single conductor primary wire •99.9% pure electrolytic copper, cabled in a ropelay design for maximum flexibility and conductivity •Made of a flame retardant compound that is highly resistant to oil, water, alkalis, ozone, grease and diesel fumes •High gloss finish •Surface printed with gauge, description and one-foot markers •Made in USA

Order #	Length	Color	(ea.)	(2-4)	(5-up)
10 Gauge: •413 strand ropelay construction					
24-1395	100'	Black	\$47.49	\$42.93	\$39.98
24-1400	250'	Red	136.00	124.00	115.00
24-1405	250'	Black	136.00	124.00	115.00

Order #	Length	Color	(ea.)	(2-4)	(5-up)
8 Gauge: •665 strand ropelay construction					
24-1410	100'	Red	\$71.49	\$64.17	\$59.74
24-1415	100'	Black	71.49	64.17	59.74
24-1420	250'	Red	210.00	191.00	177.00

Order #	Length	Color	(ea.)	(2-4)	(5-up)
4 Gauge: •1672 strand ropelay construction					
24-1430	100'	Red	\$169.00	\$155.00	\$145.00
24-1435	100'	Black	161.00	148.00	138.00

Primary Wire

Order #	Length	Color	(ea.)	(2-4)	(5-up)
10 Gauge-65 strands of 28 gauge copper wire					
24-1330	50'	Red	\$25.99	\$22.30	\$20.77
8 Gauge-65 strands of 26 gauge copper wire					
24-1360	50'	Red	39.49	34.98	32.56
24-1365	50'	Black	39.49	34.98	32.56
24-1370	100'	Red	72.49	65.63	61.12
24-1375	100'	Black	72.49	65.63	61.12

See wireless connectors on pages 196 and 197.



Data Cables

**BELDEN**

Category 6 MediaTwist® UTP Cable

Belden's 1000' MediaTwist® Cat 6 UTP cable is a unique cable design delivering the ultimate in unshielded twisted pair performance. MediaTwist features 23AWG solid bare copper conductors, and four twisted pairs bonded in a PVC jacket to effectively separate and isolate each pair minimizing NEXT interference. Jacket sequentially marked at two foot intervals, and nominal O.D. is 0.365. Mfr. #1872A.

Order #	(ea.)	(2-4)	(5-up)
24-7170	\$306.00	\$274.00	\$271.00

BELDEN

Category 6 Dataswist® UTP Cable

Four bonded, twisted pairs of 23AWG solid bare copper conductors separated by a center rod member and individually encased in polyethylene insulation. Overall unshielded PVC jacket with ripcord sequentially marked at 2' intervals. CMR, UL444, riser rated and verified to Category 6. 0.241" outer diameter, nominal. 1000'.

Order #	Mfr. #	(ea.)	(2-4)	(5-up)
24-9680	7881A	\$249.00	\$224.00	\$222.00

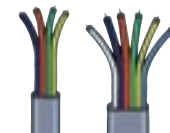

Telephone Line Cord

•Color-coded stranded wire •Custom design your own modular extension cords to any length •Silver PVC jacket •26 gauge

Order #	Length	(1-3)	(4-9)
4 Conductor			
36-460	100'	\$10.49	\$9.26
36-465	500'	41.49	37.08
6 Conductor			
36-615	100'	15.49	13.90
36-620	500'	82.49	74.16



Four Conductor Telephone Wire

Four conductor 24AWG solid bare copper conductors. Polyethylene insulation color coded red, green, black and yellow. Natural color PVC jacket.

Order #	Length	(ea.)	(2-4)	(5-up)
24-7235	1000'	\$101.00	\$91.00	\$85.00



Telephone Station Wire

•4 conductor •22 gauge solid wire •Color coded: Red, green, yellow and black •PVC/polyethylene jackets

Order #	Length	(ea.)	(2-4)	(5-up)
24-060	100'	\$18.99	\$15.45	\$14.39
24-050	500'	84.99	76.18	70.00



Primary Wire

Add distinctiveness to any automotive sound system with this clear/blue primary wire. Made from high strand, oxygen free tinned copper for maximum flexibility and performance.

Order #	AWG	Length	(ea.)	(2-4)	(5-up)
Blue					
24-4130	8	100'	\$69.49	\$62.86	\$58.54
Clear					
24-4195	4	1'	4.94	-	-

Data Cables

Stellar Labs™

Category 6 550MHz UTP Cable

Stellar Labs® Cat 6 cable is the perfect choice for gigabit ethernet and other high-bandwidth applications where lower crosstalk and system noise is critical. Verified to meet or exceed 550MHz performance, the Stellar Labs® Cat 6 cable also meets or exceeds ANSI/TIA-568-B.2-1 and ISO/IEC 11801 specifications. **Specifications:** •Four unshielded twisted pairs •23AWG solid bare copper conductors •PVC outer jacket •High-density polyethylene individual conductor insulation •Complies with Category 6 (ANSI/TIA-568) standards •Rated to 550MHz headroom or above •RoHS compliant •Convenient and durable EZ-pull reel-in-a-box •Gray in color 

Order #	Length	(1-3)	(4-8)	(9-up)
24-10320	500'	\$70.99	\$68.64	\$66.63
24-10321	1000'	141.00	137.00	131.00

Category 5e STP Cable

Shielded Cat 5e cable is commonly used in high capacity, broadband applications, such as telecommunications, networking, A/V distribution and security. 100% aluminum mylar shield with drain wire provides ultimate EMI/RFI protection. **Features:** •Four twisted, 24AWG solid bare copper conductors •High-density polyethylene insulated conductors •Gray PVC jacket •CM/CMR rated for in-wall and in-conduit use •Verified compliant with EIA/TIA 

Order #	Length	(ea.)	(2-up)
24-9720	500'	\$110.00	\$94.00
24-9725	1000'	186.00	177.00

BELDEN
BRINGING ALL THE RIGHT SIGNALS

Category 5e UTP Plenum and Non-Plenum Cable

Unshielded, four pair, 24AWG solid bare copper conductors. 1585A: Blue Flamarrrest® Plenum jacket with nylon ripcord. 1583A: Blue PVC jacket with nylon ripcord. 1000' 

Order #	Mfr. #	(ea.)	(2-4)	(5-up)
24-5100	1583A	\$164.00	\$143.00	\$141.00
24-5105	1585A	306.00	293.00	283.00

CAROL BRAND Composite Access Control Cable

Stranded bare copper wire. Blue PVC overall jacket in reel put ups. Individually shielded. Construction: 18AWG, four conductor; 22 AWG, six conductor (three twisted pair); 22 AWG, two conductor; 22 AWG, four conductor. Application markings on individual elements. Application: security systems, access control, card reader, door control, REX and power-limited controls. Compliances: NEC Article 800 type CMR (UL), c(UL) or CMP(UL), c(UL). 

Order #	Carol ID	Rating	Length	O.D.	ONLY
24-10885	4ERS4S	CMR	500'	.430	\$393.00
24-10886	4ERS4S	CMR	1000'	.430	785.00
24-10890	4EPL4S	CMP	500'	.430	469.00
24-10891	4EPL4S	CMP	1000'	.430	938.00



Category 6 CMR 550MHz Cable

Due to higher bandwidth usage and faster data transmission, Cat 6 cable is becoming the new standard in network installations. Used for networking, A/V distribution, and security, Cat 6 cable is extremely versatile. •UL listed •Four twisted 24AWG solid bare copper conductors •Blue PVC jacket •Polyethylene insulation •Convenient pull box 

Order #	Length	ONLY
24-10527	1000'	\$121.00
24-10528	500'	75.99

CAROL BRAND Category 6 500MHz Cable

23 AWG solid bare annealed copper. Polyolefin PVC jacket (CMR) and Fluoropolymer PVC jacket (CMP). Applications are IEEE 802.3, 1000 BASE-T, 100 BASE-TX, 10 BASE-T, ANSI/TIA/EIA 854, ANSI X3.263, 155 Mp/s 1.2 Gb/s ATM. 1000' length. Separator filament. Pull box put-up. 

Order #	Carol ID	Rating	Color	ONLY
24-10645	CR6.30.07	CMR	Blue	\$216.00
24-10646	CR6.30.02	CMR	White	216.00
24-10647	CR6.30.10	CMR	Gray	216.00
24-10648	CR6.30.06	CMR	Green	216.00
24-10649	CR6.30.05	CMR	Yellow	216.00
24-10650	CR6.30.03	CMR	Red	216.00
24-10651	CP6.30.07	CMP	Blue	394.00
24-10652	CP6.30.02	CMP	White	394.00
24-10653	CP6.30.10	CMP	Gray	394.00
24-10654	CP6.30.06	CMP	Green	394.00
24-10655	CP6.30.05	CMP	Yellow	394.00
24-10656	CP6.30.03	CMP	Red	394.00

Gen SPEED BRAND Category 5e Screened Cable

24 AWG solid bare annealed copper wire. 24 AWG stranded 7/32 solid tinned copper drain wire. Blue PVC jacket in Polyolefin (CMR) or Fluoropolymer (CMP). Shield: Polyester-backed aluminum foil (foil side in). **Applications:** 1000 BASE-T (Gigabit Ethernet), E52/155 Mbps ATM, E100/10 BASE-T (IEEE 802.3), 4/16 Mps Token Ring (IEEE 802.5), T1, Voice. **Compliances:** ANSI/TIA/EIA 568 B (Category 5e), ANSI/ICEA S-90661, NEC/CEC Type CMP (plenum) or CMR. 1000' length. Spool put-up. 

Order #	Mfr. #	Rating	O.D.	ONLY
24-10660	2133496E	CMR	.250	\$318.00
24-10661	2132611E	CMP	.225	669.00

Gen SPEED BRAND Category 5e Residential CMX

24 AWG solid bare annealed copper. Polyolefin PVC ivory colored jacket outdoor CMR cable. Applications are 1000 BASE-T (Gigabit Ethernet), 52/155 Mp/s ATM, 100/10 BASE-T (IEE 802.3, 4/16 Mp/s Token Ring, (IEEE 802.5), T1, Voice. Compliances ANSI/TIA/EIA 568 B.2 (Category 5e), NSI/ICEA S-100-685, NEC/CEC Type CMX Outdoor-CMR 1000' length, O.D. .210. Pull box. Mfr. #2137113E. 

Order #	ONLY
24-10667	\$152.00

WIRE & CABLE



Section
10

Stellar Labs™

Category 5e 350MHz UL CMR Cable

Ideal for today's high-speed voice, data and video applications the Stellar Labs® Cat 5e cable is UL approved, riser rated (CMR) and tested to meet both Cat 5e specifications and 350MHz bandwidth. **Specifications:** •Four unshielded twisted pairs •24AWG solid bare copper conductors •PVC outer jacket •High-density polyethylene individual conductor insulation •Complies with Cat 5e (EIA/TIA-568) standards •Rated to 350MHz headroom or above •RoHS compliant •Convenient and durable pull box 

Order #	Color	Length	MSRP	ONLY
24-10515	Blue	500'	\$59.95	\$45.49
24-10505	Blue	1000'	99.95	79.99
24-10520	Gray	500'	59.95	45.49
24-10510	Gray	1000'	99.95	79.99
24-10526	White	500'	59.95	45.49
24-10525	White	1000'	99.95	79.99

Stellar Labs™

Category 5e 350MHz UTP Cable

Ideal for today's high-speed voice, data, and video applications, the Stellar Labs® Cat 5e cable is not only tested to meet both Cat 5e specifications and 350MHz bandwidth, but also offers excellent flexibility in a convenient and durable EZ-pull reel-in-a-box. **Specifications:** •Four unshielded twisted pairs •24AWG solid bare copper conductors •PVC outer jacket •High-density polyethylene individual conductor insulation •Complies with Category 5e (EIA/TIA-568) standards •Rated to 350MHz headroom or above •RoHS compliant 

Order #	Color	Length	(1-3)	(4-up)
24-10300	Gray	500'	\$39.49	\$35.33
24-10306	Red	1000'	79.99	70.66
24-10310	Yellow	500'	45.49	40.37
24-10311	Yellow	1000'	75.99	70.66
24-10315	Blue	500'	39.49	35.33

CAROL BRAND Category 5e 350MHz Cable

24 AWG solid bare annealed copper. Polyolefin PVC jacket (CMR) and Fluoropolymer PVC jacket (CMP). Applications are IEEE 802.3, 1000 BASE-T, 100 BASE-TX, 10 BASE-T, ANSI X3.263, 52/155 Mp/s ATM, 4/16 Mp/s Token Ring. 1000' length. pull box put-up. 

Order #	Carol ID	Rating	Color	ONLY
24-10630	CR5.30.07	CMR	Blue	\$107.00
24-10631	CR5.30.02	CMR	White	107.00
24-10632	CR5.30.10	CMR	Gray	107.00
24-10633	CR5.30.06	CMR	Green	107.00
24-10634	CR5.30.05	CMR	Yellow	107.00
24-10635	CR5.30.03	CMR	Red	111.00
24-10636	CP5.30.07	CMP	Blue	257.00
24-10637	CP5.30.02	CMP	White	257.00
24-10638	CP5.30.10	CMP	Gray	257.00
24-10639	CP5.30.06	CMP	Green	257.00
24-10640	CP5.30.05	CMP	Yellow	257.00
24-10641	CP5.30.03	CMP	Red	257.00

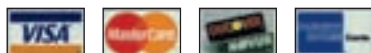



WIRE & CABLE

Section 10



RIP-TIE WrapStrap™

- Sometimes it is not necessary to attach the cable wrap to the cable
- Perfect for car installs or where the wiring might need to be rerouted or removed
- Wrapstrap™ is a single strip of double-sided hook and loop fastener that quickly and easily wraps around almost anything
- Cut to length
- Black

Order #	Dimensions (W) x (L)	(1-2 pkgs.)	(3 pkgs.-up)
21-4757	1/2" x 10'	\$7.36	\$5.52
21-4759	1/2" x 75'	23.49	20.78



RIP-TIE CableWrap

- Fastest, easiest, and tidiest way to keep harnessed cords organized and coiled cables neat and ready for storage
- Specifically designed to eliminate the frustration, inconvenience and mess associated with older cable organization methods
- Attaches to any cable

permanently, patented Velcro® and nylon tie design means they are reusable for 10,000 times •Available in different colors and lengths •Ten pieces per package

Order #	Dimensions (W) x (L)		Color	(1-2 pkgs.)	(3 pkgs.-up)
	Color	(1-2 pkgs.)			
21-4745	1" x 6"	Black	\$19.49	\$17.44	
21-4746	1" x 6"	Rainbow	19.49	17.44	
21-4747	1" x 9"	Black	20.49	19.38	



RIP-TIE Lite™

- End the frustration of lost cable ties forever
- Especially designed for places where industrial strength is not needed, perfect for where cables are rearranged less frequently
- One piece design is based on the patented Rip-Tie® CableWrap and can be reused 300 times
- Attaches to a single cable and stays in place
- Won't damage delicate cables
- Available in different colors and lengths
- Ten pieces per package

Order #	Dimensions (W) x (L)		Color	(1-2 pkgs.)	(3 pkgs.-up)
	Color	(1-2 pkgs.)			
21-4752	1/2" x 5"	Black	\$8.47	\$6.61	
21-4753	1/2" x 5"	Rainbow	7.36	6.81	
21-4754	1/2" x 8"	Black	9.58	8.30	
21-4755	1/2" x 8"	Rainbow	9.58	8.30	
21-4756	1/2" x 12"	Black	12.99	9.99	



RIP-TIE CableCatch™

- Tidy way to organize cables against a surface
- Permanently adheres to desks and equipment racks
- Fast hook and loop cable release
- Easy

change of equipment and cords •Available in different colors and lengths •Five pieces per package

Order #	Dimensions (W) x (L)		Color	(1-2 pkgs.)	(3 pkgs.-up)
	Color	(1-2 pkgs.)			
21-4748	1" x 2"	Black	\$16.49	\$12.08	
21-4749	1" x 2"	Gray	16.49	11.73	
21-4750	1" x 4"	Black	18.49	13.66	
21-4751	1" x 4"	Gray	18.49	13.26	

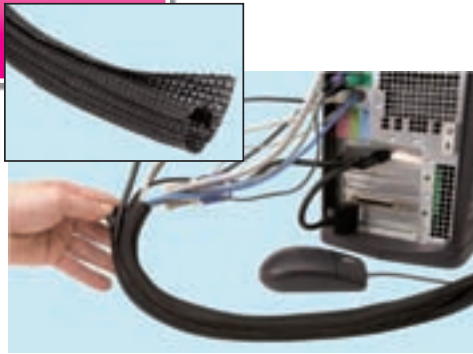

Flexible, Semi-Rigid Split Braided Tube

F6's unique split, semi-rigid braided construction makes it the ideal solution for situations where ease of installation is of primary importance. The lateral split allows the tube to open up to accommodate a wide variety of bundling requirements, and the semi-rigid braid configuration simply closes around the entire installation without the need for any additional fasteners (velcro, tape, etc.).

Features:

- Lightweight and flexible
- Easy installation
- Soft and quiet in high vibration uses
- 25% edge overlap
- Cut and abrasion resistant
- Can withstand temperatures of -103°F~257°F
- Melting temperature: 446°F

Order #	Nominal Diameter	Length	(1-3)	(4-up)
21-8318	1/2"	75'	\$47.49	\$38.89
21-8320	3/4"	50'	42.49	36.19
21-8322	1"	25'	32.49	26.29
21-8324	1 1/2"	25'	53.49	47.14



Velleman Cable Tying Tool

•Handy cable tying tool is a must for any cable TV installer or IT person

•Can quickly and easily be used with cable ties with an outside diameter of up to 0.09"

•Convenient cutter knife included

•Length: 6.3"

Order #	ONLY
22-11730	\$12.49



Wire Tie Tensioning Tools

Heavy-duty, very high-quality automatic tensioning tools comparable to those commonly found at twice the price. Ratcheting action tightens tie, to a tension preset on the tool handle, then automatically cuts off excess tie length. Works with all nylon wire ties.

Order #	Description	(1-3)	(4-up)
21-3225	Plastic	\$17.49	\$15.87
21-3230	Metal	25.49	22.94

Wire Management



Clean Cut™ Fray Resistant Sleeving

Flexo Clean Cut is ideal for field installers and other situations where access to a hot knife is impossible. Simply cut with scissors for an easy, safe, and professional installation.

Features:

- Lightweight and flexible
- UV resistant
- Cuts easily with scissors
- Increased braid density for fuller coverage
- High abrasion resistance
- Operating temperature: -103°F~257°F
- Melting temperature: 446°F
- Color: Black

Order #	Nominal Diameter	Length	(1-3)	(4-up)
21-8282	3/8"	25'	\$11.99	\$10.61
21-8284	1/2"	25'	13.99	12.01
21-8286	3/4"	25'	16.49	14.24
21-8288	1"	25'	19.49	16.98
21-8290	1 1/4"	25'	20.49	18.67
21-8292	1 1/2"	25'	27.49	24.12
21-8294	3/8"	100'	50.49	46.07
21-8296	1/2"	100'	40.49	38.37
21-8298	3/4"	75'	53.49	47.84
21-8300	1"	50'	42.49	37.32
21-8302	1 1/4"	50'	48.49	44.39
21-8304	1 1/2"	50'	63.99	55.14



HellermannTyton Grip-Ties

Constructed of Velcro® hook and loop material, grip-ties are a low profile, single piece fastening device that can be removed and re-used for repetitive access to cabling. Because they cannot be over cinched, they are safe for Cat 5 and fiberoptic cable. Available in a variety of sizes, grip-ties can be used for most any wire bundling applications.

Order #	Width	Length	Price per pkg.	
			(1-9)	(10-up)
10 per pkg.				
21-4000	1/2"	6"	\$10.49	\$9.81
21-4020	1/2"	8"	10.99	10.32
21-4040	1/2"	11"	11.99	11.30
21-4060	3/4"	15"	18.99	17.90
100 per pkg.				
21-4010	1/2"	6"	69.49	66.45
21-4030	1/2"	8"	84.99	81.07
21-4050	1/2"	11"	93.49	-
21-4080	1/2"	180" roll	12.99	-

Don't See The Part You Need?

Call our Quotes Team

1-800-543-4330

email: quotes@mcmelectronics.com

Wire Management

WIRE & CABLE



Section 10



HellermannTyton Bulk Cable Ties

•Packaged 1000 per box for large users



Order #	Length Color	Tensile Strength	Price per box		
			(1-3)	(4-9)	(10-up)
21-7550	4"	18 lbs	\$14.49	\$12.86	\$12.12
21-7552	4" Natural	18 lbs.	14.49	13.02	12.63
21-7554	8" Black	30 lbs.	32.49	29.38	28.50
21-7556	8" Natural	50 lbs.	32.49	29.38	28.50
21-7558	5.5" Natural	18 lbs.	21.49	20.14	19.13
21-7560	8" Black	30 lbs.	32.49	29.38	28.50

Wire Tie Belt Holder

•Used to dispense any size cable tie easily and efficiently •Handy for electricians, cable installers, HVAC installers, mechanics and many more •Transports, stores, and organizes cable ties •Lightweight and compact •3 1/16" (W) x 2 3/16" (H)



Order #	ONLY
21-9445	\$8.07



Bulk Cable Ties

•Length: 8" •Width: 0.098" •Tensile strength: 250 lbs. •Color: Natural •Packaged 1000 per box for large users

Order #	(1-3)	Price per box (4-9)	(10-up)
21-7650	\$20.49	\$19.18	\$18.17



3M Cable Tie Assortment Pack

These cable ties secure wire bundles and harness components quickly, without slipping. The self-locking head, with heavy double teeth on the one-piece lock mechanism assures reliability. Ties are designed to meet a wide range of temperatures from -40°F~185°F. This assortment pack contains 100 of the most commonly used ties. Sizes include 4", 5", 7.5", and 11" in natural and black weather resistant colors.



Order #	ONLY
108-3890	\$28.49

Saddle Type Wire Tie Mount

Screw mounted nylon saddle anchor accepts all standard nylon wire ties. Ideal for applications where large cable must be secured and appearance is critical. 50 per bag. Natural color.



Order #	Base Dimensions (mm)	Max. Tie Width (mm)	Price Per Bag		
			(1-4)	(5-9)	(10-up)
21-3662	19.0 x 09.5	3.4	\$2.41	\$2.07	\$1.99
21-3664	15.0 x 10.0	3.0	3.12	2.55	2.12
21-3666	23.0 x 16.0	6.0	3.73	3.31	3.14

Self Adhesive Cable Tie Mounts

Nylon tie mount base accepts standard cable ties up to 3/16" wide. Self adhesive backing attaches to any smooth surface. 100 per bag. Available in black or natural color.



Order #	Color	Base Dimensions (mm)	(1-4)	Price Per Bag (5-9)	(10-up)
21-3684	Natural	21 x 21	\$11.99	\$9.85	\$8.34
21-3686	Black	21 x 21	11.99	9.85	8.34
21-3688	Natural	28 x 28	17.49	14.97	13.81
21-3690	Black	28 x 28	17.49	14.97	13.81

Cable Ties

•100 per bag



Order #	Length	Color	Bundle Size	Price Per Bag		
				(1-9)	(10-49)	(50-up)
21-3552	4"	Black	3/4"	\$3.22	\$2.62	\$2.41
21-3562	4"	Natural	3/4"	3.32	2.70	2.48
21-3554	6"	Black	1 1/4"	4.43	4.11	3.44
21-3564	6"	Natural	1 1/4"	4.43	4.11	3.44
21-3556	8"	Black	2"	5.54	4.78	3.95
21-3566	8"	Natural	2"	5.75	4.69	3.87
21-3568	11 1/4"	Natural	3"	8.78	7.90	7.28
21-3560	14 1/2"	Black	4"	9.08	8.21	6.76
21-3570	14 1/2"	Natural	4"	9.08	7.97	6.55



Economy Cable Ties

•100 piece packs of economic ties •UL listed

Order #	Length	Color	(1-9)	(10-24)	(25-49)	(50-up)
21-3553	4"	Black	\$2.11	\$1.91	\$1.76	\$1.59
21-3563	4"	Neutral	2.11	1.91	1.76	1.59
21-3555	6"	Black	1.10	0.96	0.92	0.90
21-3565	6"	Neutral	1.10	0.96	0.92	0.90
21-3559	12"	Black	3.52	3.41	3.28	3.18
21-3569	12"	Neutral	3.52	3.41	3.28	3.18

HellermannTyton Standard Cable Ties

•100 per bag

Order #	Length	Color	Tensile Strength	Bundle Size	Price Per Bag	
					(1-3)	(4-up)
21-1320	4"	Natural	18 lbs.	3/4"	\$1.81	\$1.76
21-1325	4"	Black	18 lbs.	3/4"	1.61	1.46
21-1330	6"	Natural	30 lbs.	1 1/4"	2.31	2.14
21-1335	6"	Black	30 lbs.	1 1/4"	2.31	2.14
21-1340	7 1/2"	Natural	30 lbs.	2"	3.12	2.93
21-1345	7 1/2"	Black	30 lbs.	2"	3.12	2.93
21-1350	11 1/4"	Natural	30 lbs.	3"	5.44	5.08
21-1355	11 1/4"	Black	30 lbs.	3"	5.44	5.08
21-1360	14 1/2"	Natural	30 lbs.	4"	6.86	6.36
21-1365	14 1/2"	Black	30 lbs.	4"	6.86	6.36

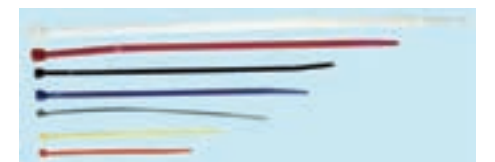

1100 Piece Cable Tie Kit

•Contains 1100 of the most popular sizes of cable ties •Ideal for light duty applications •Each size is color coded for easy identification •Kit includes: 300 each of sizes 1/8" x 4", 1/8" x 5", 250 each of 1/8" x 6", 100 each of 1/8" x 7", 80 each of 3/16" x 8", 50 each of 3/16" x 10", and 20 each of 3/16" x 12".

Order #	ONLY
22-7556	\$11.99

HellermannTyton Mounting Cable Ties

•100 per bag

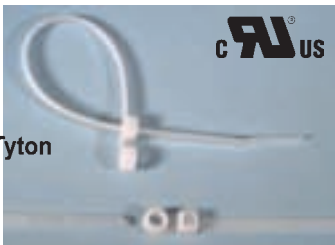

Order #	Mounting	Length	Tensile Strength	Bundle Size	Per Bag	
				(1-3)	(4-up)	
Natural						
21-1405	#8 screw	6 1/4"	30 lbs.	1 1/4"	\$5.34	\$5.16
21-1410	#10 screw	8 1/2"	50 lbs.	1 1/4"	7.26	6.75
Black						
21-7320	#10 screw	8 1/2"	50 lbs.	1 1/4"	6.55	3.91

HellermannTyton Heavy-Duty Cable Ties

•50 per bag •120 lbs. tensile strength

Order #	Length	Color	Bundle Size	Price Per Bag	
			(1-3)	(4-up)	
21-1370	8 1/4"	Natural	2"	\$8.47	\$7.83
21-1375	8 1/4"	Black	2"	8.47	7.83
21-1385	11 1/4"	Black	3"	9.58	8.81
21-1390	15 1/4"	Natural	4"	11.49	10.55
21-1395	15 1/4"	Black	4"	11.49	10.55

HellermannTyton Identification Cable Ties

•Tie and identify cable in one operation •Natural color •4 1/4" length •100 per bag •18 lbs. tensile strength •3/4" bundle size •Priced per bag

Order #	(1-3)	(4-up)
21-1440	\$7.36	\$6.85

HellermannTyton Cable Tie Mounting Base

•Adhesive or screw mounting •Insertion can be made from all four sides •Fits nylon ties up to 6.15mm (W) x 1.58mm (thick)



Order #	Color	Quantity Per Pack	(1-3 pkgs.)	(4 pkgs.-up)
21-1460	White	100	\$19.49	\$17.62
21-2700	Black	100	19.49	17.62
21-2705	White	25	3.12	2.97

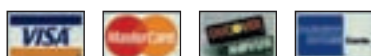



Section 10

WIRE & CABLE



FLEXO
Wrap

Nylon Braided Cable Wrap

Features: •Ideal for audio/video and computer systems for a professional look •Heavy-duty hook and loop fasteners for frequent access to cables •Lightweight and flexible •UV resistant •High abrasion resistance •Cuts easily with a hot knife (MCM #21-6815 iron and #21-6845 tip) •Operating temperature: -103°F~257°F •Must be cut with a hot knife to avoid unraveling •Available in 6' and 25' lengths

Order #	Nominal Diameter	Length	(1-3)	(4-up)
21-8306	3/4"	6'	\$18.49	\$16.11
21-8308	1 1/4"	6'	23.49	20.76
21-8310	2"	6'	25.49	21.97
21-8312	3/4"	25'	53.49	48.43
21-8314	1 1/4"	25'	90.99	85.32
21-8316	2"	25'	90.99	85.32



Cable Clamp Organizer Pack **NEW!**

•Easy to use cable clamps are perfect for organizing a wide variety of applications •Clamps can be used on cords, cables, keys, ropes, hoses and much more •Great for tools, computers, video games, appliances, and A/V equipment •One hand operation •Reusable •Protects cables by not clinching •Self-aligning •Easy release without using tools •Made of durable polymers and stainless steel

Order #	Clamp Types	ONLY
21-9430	One medium and four small	\$8.07
21-9431	One medium and three small	6.55
21-9432	One large, one medium and one small	7.06
21-9433	Two medium and three small	9.08
21-9434	One large (blue), one medium (red), and two small	8.57

Wire Management



Split Loom Tubing

•Used to protect and hide automobile electrical wiring •Black •Available in 30', 50' and 100' lengths

Order #	(I.D.)	Length	(1-9 pkgs.)	(10 pkgs.-up)
28-1505	1/4"	50'	\$6.25	\$5.31
28-1510	1/4"	100'	11.49	9.63
28-1110	1/2"	30'	5.56	4.78
28-1525	1/2"	50'	8.27	7.09
28-1530	1/2"	100'	17.49	14.45
28-1965	3/4"	30'	10.99	9.26
28-1975	3/4"	100'	27.99	23.64

KORALLY Rally-Rap®

This spiral-cut wrap applies a strong grip on wire harnesses due to the torsional cut and memory properties of polyethylene plastic. Rally-Rap will retain its strength under repeated flexing over complex, long and continuous wire paths. Ideal for car stereo installations that require break out of multiple leads and resistance to ultraviolet rays. Available in black on a 100' spool.

Order #	Bundle Size	ONLY
95-735	1/4"	\$26.99
95-740	3/8"	32.49
95-745	1/2"	40.49



VANCO Split Loom Tubing

Perfect for bundling multiple cables in audio, computer and automotive applications. White color is especially useful in home theater installations, as it blends easily with walls. Heavy convoluted construction is split on one side, allowing easy insertion of cables. All rolls are 100' length.

Order #	Diameter	Color	(1-3)	(4-up)
60-4400	1/4"	Black	\$8.07	\$7.75
60-4401	3/8"	Black	11.49	10.70
60-4402	1/2"	Black	17.49	16.47
60-4403	3/4"	Black	22.49	21.20
60-4405	1"	Black	26.49	25.24
60-4415	1"	White	34.49	33.32



PLATINUM TOOLS J-Hook

•Perfect for the cabling industry, repair shops and home projects: Telecom/voice, network/data, broadband, satellite, CCTV, fiber, and flexible conduit •Over-molded with polypropylene for ultra smooth cable glide eliminates cable snags •Re-lockable cable cage require no tools •Molded-in hook for fast lock and latch

Order	Mfr#	Description	Size	ONLY
21-9405	CCP16-100	1" standard	16	\$2.72
21-9406	CCP16W-100	1" batwing	16	3.42
21-9407	CCP16AC-100	1" 90°	16	3.02
21-9408	CCP32-100	2" standard	32	3.12
21-9409	CCP32W-100	2" batwing	32	4.03
21-9410	CCP32AC-100	2" 90°	32	3.52
21-9411	CCP48-25	3" standard	48	6.35
21-9412	CCP48W-25	3" batwing	48	7.06
21-9413	CCP48AC-25	3" 90°	48	6.55



3M Dual Lock Reclosable Fasteners

•Reclosable fasteners are handy in the home, office or shop and for a variety of applications •With an open/close life of 1000 (#108-4365, #108-4370, #108-4375, #108-4380) or 100 (#108-4355 and #108-4360) they can be used over and over again •Performs in a variety of temperatures and attaches to a variety of surfaces •Dimensions: 1" x 10'

Order #	Surfaces	Color	Temperature	Environment	ONLY
108-4355	Metals, glass, plastics, powder coated paints, Medium to low energy surface materials	Clear	Low to medium	Indoor	\$15.99
108-4360	Metals, glass, plastics, powder coated paints, Medium to low energy surface materials	Black	Low to medium	Indoor	15.99
108-4365	Many Plastics, powder coated paints, Low surface energy materials	Black	Low	Indoor	24.99
108-4370	Plastics, powder coated paints, Medium to low surface energy materials	Black	Medium	Indoor/Outdoor	24.99
108-4375	Metals, glass, medium to high surface energy Plastics and paints	Black	High Outdoor	Indoor/Outdoor	24.99
108-4380	Metals, glass and high surface energy plastics	Clear	Highest	Indoor/Outdoor	24.99

Carlon Resi-Guard Flexible Raceway Fittings

This complete line of one-piece quick connect couplings, threaded adaptors and snap in terminator adaptors provides easy, professional installation of flexible raceway. All pieces are sold individually.

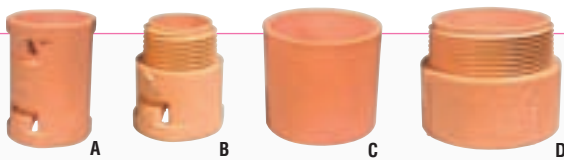

Fig.	Order #	Description	(1-3)	(4-9)	(10-up)
A	28-17185	3/4" quick coupling	\$1.00	\$0.77	\$0.72
B	28-17190	3/4" threaded adaptor	1.81	1.54	1.44
C	28-17200	2" standard coupling	1.00	0.98	0.96
D	28-17205	2" threaded adaptor	1.30	1.05	0.95

Carlon Resi-Guard Flexible Raceway

Ideal for providing a main chase from the main distribution panel to a secondary hub in the attic or basement, Resi-Guard nonmetallic flexible raceway is available in 1/4" and 2" diameters. It is hand bendable, lightweight and easily cut-to-length to reduce scrap. Additionally, the 2" diameter size includes a factory-installed 900 lb. pull tape. Bright orange color clearly signifies a low-voltage installation.

Order #	Diameter	Length	(1-3)	(4-9)	(10-up)
28-17210	3/4"	100'	\$55.49	\$50.31	\$49.05
28-17215	2"	50'	80.49	75.15	72.06



See low-voltage brackets on pages 141 and 142.

Wire Management

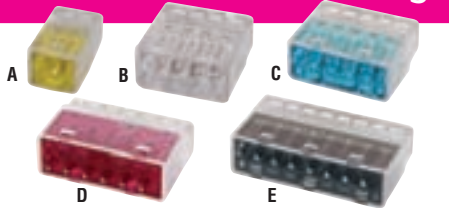

multicomp

EZ-Splice Push-n-Lock Connectors

No more twisting wires with wire nuts! Designed to simplify electric terminations, these closed-end connectors make splicing both solid and tin stranded 22~12AWG electrical wires fast and convenient (reusable when using solid wire). UL listed for 24A and RoHS compliant, these splice connectors are rated for 600V and 105°C. **Minimum ten.**

Fig.	Order #	Conductors	ONLY
A	27-5700	2	\$0.19
B	27-5702	4	0.19
C	27-5703	5	0.29
D	27-5704	6	0.30
E	27-5705	8	0.39

Nylon Cable Clamps

Standard screw mount clamp holds wire up to 1/2" diameter. Natural color. 50 per bag.



Order #	I.D.	Width	(1-4 bags)	(5-9 bags)	(10 bags-up)
21-3668	1/8"	3/8"	\$3.12	\$2.82	\$2.69
21-3672	1/4"	1/2"	2.62	2.12	1.81
21-3676	3/8"	5/8"	3.12	2.93	2.79
21-3680	1/2"	3/4"	3.32	3.10	2.87



HellermannTyton

Cable Clamps

Securely fastens loose wires •50 per bag

Order #	Size	Color	(1-3 bags)	(4 bags-up)
21-1515	1/4"	Natural	\$2.21	\$2.10
21-2465	1/4"	Black	3.52	3.22
21-1520	3/8"	Natural	3.52	2.14
21-2470	3/8"	Black	4.03	3.72
21-2475	1/2"	Black	4.23	3.91
21-1530	3/4"	Natural	5.75	5.09
21-2480	3/4"	Black	5.54	5.18
21-1535	1"	Natural	3.83	3.56
21-2485	1"	Black	5.75	5.28

Self Adhesive Cable Clamps

Durable nylon clips securely hold cable up to 1/2" diameter. Ring can be re-opened for easy removal and reinsertion of cable. 50 per bag. Black.



Order #	I.D.	(1-4)	Price Per Bag (5-9)	(10-up)
21-3652	1/4"	\$8.98	\$8.21	\$7.88
21-3656	1/2"	12.99	11.56	11.12
21-3660	3/4"	13.99	12.28	11.80

KORALLY

Vinyl Grommet Variety Pack

Includes a total of 26 pieces •Assorted sizes: 1/4", 3/8", 1/2", 5/8", 3/4", 1" •Black

Order #	(1-9 pkgs.)	(10 pkgs.-up)
95-580	\$3.22	\$2.62

KORALLY

Vinyl Grommet Assortment Pack

Includes a total of 28 pieces •Assorted sizes: 1/2", 3/4", and 1" •Black

Order #	(1-9 pkgs.)	(10 pkgs.-up)
95-575	\$3.32	\$2.74

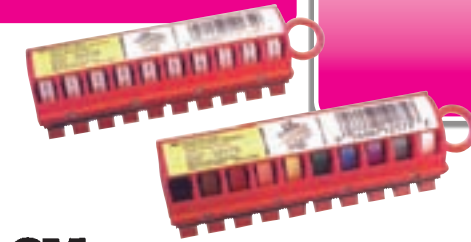

3M ScotchCode™ Wire Labeler

•These compact ScotchCode dispensers provide fast, convenient labeling of wire and cable •Resistant to flapping, dirt, oil and heat •Dispensers available with ten rolls of numbered tape (one each of 0-9), or ten rolls of different colored tape

Order #	Labeler Type	Per Roll	ONLY
108-030	Number	8'	\$52.49
108-035	Colored	8'	52.49

Order #	Refill	Order #	Refill
108-040	"0"	108-065	"5"
108-045	"1"	108-070	"6"
108-050	"2"	108-075	"7"
108-055	"3"	108-080	"8"
108-060	"4"	108-085	"9"

\$3.49 (ea.) \$2.98 (2-up)



Concrete 1/4" Anchor Kit

Widely used for many types of SATV and security installations. **Kit contains:** •100 1/4" pan-head screws •100 #8 plastic anchors •One masonry drill bit (1/4")

Order #	ONLY
28-11076	\$4.13

3M Write-On Wire Marker Dispenser

Light weight and durable dispensers with markers. Use to mark wire, motor panels, or sub-assemblies. Each dispenser contains a black marker pen and 70 labels, except for #108-3223 which contains 250 labels.

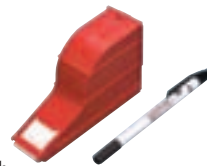

Order #	Description	ONLY
108-3222	Dispenser with 1" x 2.5" labels	\$40.99
108-3223	Dispenser with 3/4" x 1 1/8" labels	42.99
108-3308	Refill for #108-3223	26.99

HellermannTyton

Rite-On Wire Markers

•Self-laminating wire and cable markers •Ideal for marking multiple cable runs •Temperature range: -50°~200°F

Order #	(1-3)	(4-up)
21-1510	\$10.99	\$9.79



IDEAL Cable Staples

•Carbon steel, insulated. •Secures and protects NM sheathed cable, UF cable and TV lead wires •Sharp pointed legs will not split wood •500 pieces per box



Order #	ONLY
22-3064	\$21.99

WIRE & CABLE



Section 10



Coax Seal

•Hand-moldable plastic seal is perfect for sealing outdoor connections and cable splices •1/2" width •60" length

Order #	MSRP	(1-9)	(10-24)	(25-49)	(50+)
33-10945	\$4.99	\$2.11	\$1.93	\$1.85	\$1.80

Cable Clips

•Make any cable run look neat and secured in place by attaching coax or telecom cabling to walls and trim with high-impact plastic cable clips •Each clip includes a plated steel nail •100 clips per package



Order #	Description	(1-9)	(10-24)	(25-49)	(50+)
33-10850	Single, white	\$2.11	\$1.91	\$1.76	\$1.59
33-10852	Dual, white	2.62	2.39	2.20	1.98
33-10854	Single, black	2.11	1.91	1.76	1.59
33-10856	Dual, black	2.62	2.39	2.20	1.98

Flex Cable Clips

•Remarkably strong flexible clips grab cables without damaging them •Integrated Philips hex-head screws make installation quick and easy •100 clips per package



Order #	Description	(1-9)	(10-24)	(25-49)	(50+)
33-10860	Single, white	\$3.12	\$2.90	\$2.79	\$2.70
33-10862	Dual, white	3.12	2.90	2.79	2.70
33-10864	Single, black	3.12	2.90	2.79	2.70
33-10866	Dual, black	3.12	2.90	2.79	2.70

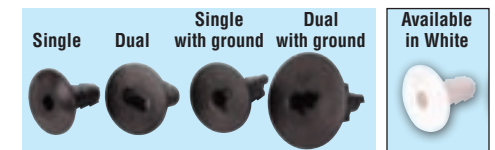

Feed-Through Cable Bushings

•Gives a finishing touch and protection to through-wall cable installations •Available in single, dual, and ground-wire knock-out configurations •100 per package

Order #	Description	(1-9)	(10-24)	(25-49)
33-10870	Single, white	\$3.12	\$2.90	\$2.79
33-10871	Dual, white	3.12	2.90	2.79
33-10872	Single, black	3.12	2.90	2.79
33-10873	Dual, black	3.12	2.90	2.79
33-10874	Single with ground, white	3.12	2.90	2.79
33-10875	Dual with ground, white	3.73	3.38	3.25
33-10876	Single with ground, black	3.12	2.90	2.79
33-10877	Dual with ground, black	3.73	3.38	3.25

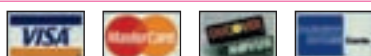



WIRE & CABLE

Section 10

KORALLY

Heat Shrink Spools

•Polyolefin heat shrink in assorted colors



Size (I.D.)	Spool Length	Black Order #	Clear Order #	White Order #	Red Order #	Yellow Order #	Blue Order #	ONLY
1/8"	70'	95-300	95-345	95-390	-	95-480	-	\$25.49
3/16"	65'	95-305	95-350	95-395	-	-	95-530	26.99
1/4"	60'	95-310	95-355	95-400	95-445	-	95-535	26.99
5/16"	50'	95-315	95-360	95-405	95-450	95-495	95-540	26.99
3/8"	40'	95-320	95-365	95-410	95-455	95-500	95-545	26.99
1/2"	35'	95-325	95-370	-	95-460	-	95-550	26.99
5/8"	32'	95-330	95-375	95-420	95-465	-	-	26.99
3/4"	24'	95-335	95-380	-	95-470	-	-	26.99
1"	16'	95-340	95-385	-	-	-	-	26.99



KORALLY 4' Sections

•Polyolefin heat shrink in assorted colors

Size (I.D.)	Black Order #	Clear Order #	White Order #	Red Order #	Yellow Order #	Blue Order #	(1-9)	(10-up)
1/8"	-	95-055	95-105	95-155	95-205	95-250	\$1.81	\$1.37
3/16"	95-010	95-060	95-110	95-160	95-210	95-255	2.01	1.70
1/4"	95-015	95-065	95-115	95-165	95-212	95-260	2.11	1.80
5/16"	95-020	95-070	95-120	95-170	95-215	95-265	2.51	2.22
3/8"	95-025	95-075	95-125	95-175	95-220	95-270	3.02	2.76
1/2"	95-030	95-080	95-130	95-180	95-225	95-275	3.42	3.20
5/8"	95-035	95-085	95-135	95-185	95-230	95-280	3.83	3.50
3/4"	95-040	95-090	95-140	95-190	-	95-285	5.24	4.75
1"	95-045	95-095	-	95-195	-	95-290	7.06	6.49
1 1/2"	95-050	95-100	-	-	-	95-295	12.99	10.76

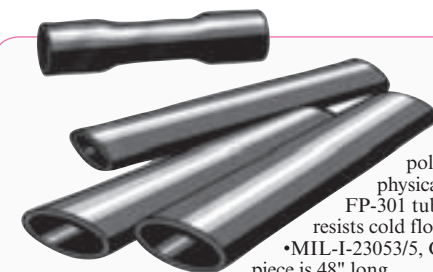

3M Heat Shrink Tubing 4' Sections



3M™ Thin Wall Tubing FP-301 is a heat shrinkable flexible polyolefin tubing that offers an outstanding balance of electrical, physical and chemical properties for a wide variety of applications.

FP-301 tubing is split resistant, mechanically tough, easily marked and resists cold flow. •UL Recognized and CSA Certified at 600V at 257°F (125°C) •MIL-I-23053/5, Class 1,2. AMS 3636 (Type I) and AMS 3637 (Type II) •Each piece is 48" long

Size I.D.	Black Order #	Blue Order #	Clear Order #	Red Order #	White Order #	Yellow Order #	(1-9 pkgs.)	(10 pkgs.-up)
1/8"	108-2805	108-2810	108-2815	-	-	108-2830	\$1.79	\$1.57
3/16"	108-2705	108-2710	108-2715	108-2720	-	-	1.79	1.58
1/4"	108-2605	108-2610	108-2615	108-2620	108-2625	108-2630	1.89	1.67
5/16"	108-2505	108-2510	108-2515	108-2520	108-2525	-	2.19	1.97
3/8"	108-2405	108-2410	108-2415	108-2420	108-2425	108-2430	2.39	2.19
1/2"	108-2305	-	108-2315	108-2320	108-2325	108-2330	3.19	2.95
5/8"	108-2205	108-2210	108-2215	-	108-2225	-	3.69	3.34
3/4"	108-2105	-	-	-	-	-	3.79	3.11
1"	108-2005	-	108-2015	-	-	-	6.49	5.78



KORALLY Colored Heat Shrink

•Package contains 6" pieces of polyolefin heat shrink tubing in 11 assorted colors •Ideal for wire identification and coding •11 pieces per package

Order #	Size	(1-9 pkgs.)	(10 pkgs.-up)
95-750	3/8"	\$6.55	\$5.95
95-755	1/4"	6.15	5.23
95-760	3/16"	4.94	4.12
95-765	1/8"	4.33	3.58
95-770	3/32"	4.03	3.24
95-775	1/16"	3.32	2.75



KORALLY Moisture-Proof Heat Shrink

Flexible, adhesive-lined heat shrink tubing

designed to insulate, seal and protect components and electrical splices from moisture and corrosion. Available in black 6" lengths.

Order #	Size	Qty. Per Pkg.	(1-9 pkgs.)	(10 pkgs.-up)
95-630	1/8"	14	\$11.49	\$9.54
95-635	3/16"	12	11.49	9.54
95-640	1/4"	10	11.49	9.54
95-645	3/8"	9	11.49	9.54
95-650	1/2"	8	11.49	9.54
95-655	3/4"	5	11.49	9.54
95-660	1"	4	11.49	9.54
95-665	1 1/2"	3	11.49	9.54

Wire Management



DURATOOL

Heat Gun Kit

•Heavy-duty heat gun for heat shrink tubing, paint removal, softening materials, and more •Two heating powers: Up to 1000°F at 16ft³/min; and up to 750°F at 9ft³/min Includes: •Heat gun •Four nozzles •Scraper with handle •Blow molded case

Order #	MSRP	ONLY
22-10225	\$59.99	\$30.49



Micro-Therm™ Flameless Heat Gun

•The compact size with heat deflector makes this an easy to use source of flameless heat whether you're working with shrinkable packaging, spot-drying paint, bending plastics or activating adhesives •Piezo electronic ignition system with safety lock •Hot air temperature up to 650°C (1250°F) •Powered by IRODA RC-30 refill cartridge or disposable gas lighter (inexpensive and readily available) •Mfr. #MJ-600

Order #	ONLY
21-9275	\$16.49

KORALLY Mini Heat Gun and Heat Shrink Tubing Kit

This kit includes a compact, lightweight heat gun and 60 pieces of heat shrink tubing. The mini heat gun is ideal for shrinking heat shrink tubing. Heat gun features: •Nozzle temperature to 1,000°F •6' electrical cord with workbench storage loop •Uses standard 110V outlet •The general purpose heat shrink tubing shrinks to 1/2 of its original size •Includes a total of 60 pieces •Sizes include 1/8", 3/16", 1/4", 3/8" and 1/2"

Order #	Description	Price per kit (1-3)	(4-up)
95-810	Mini heat gun and shrink tubing kit	\$45.49	\$41.36
95-815	Replacement heat shrink tubing kit only (60 pcs.)	11.49	10.49



Scotch® Rubber Splicing Tape 23

Self fusing tape offers maximum protection to cable splices and connections. Specially formulated rubber material fuses to itself as it is wrapped around material.

Designed for use as primary insulation on cable splices through 69KV, 30 mil thickness. Temperature rating is 194°F. Black color.

Order #	Size	(1-2)	(3-up)
108-979	1" x 30'	\$17.49	\$15.58



Heat Shrink Tubing Kit

•High-quality heat shrink tubing kit meets UL and Mil-Spec standards •Shrinks to 50% of original diameter using heat application of 250°F •23 pieces of 6" assorted sizes (1/16", 1/8", 3/16", 1/4", 3/8", 1/2", 3/4" and 1")

Order #	(1-9 kits)	(10-24 kits)	(25-49 kits)
21-1565	\$7.36	\$6.71	\$6.37



2:1 Heat Shrink Tubing

•Shrink ratio 2:1 •Shrink temperature 158°F~230°F •Operating temperature -67°F~257°F •Material: cross-linked, thermally stabilized flame-retardant polyolefin
 •UL recognized UL224, VW-1, C-UL CSA 22.2 OFT •Meets MIL AMS- DTL-23053/5 class 1 and 3 •RoHS compliant



Size (I.D.) (Inches) (Millimeter)	Cut Length	Pieces per Pack	Black Order #	Clear Order #	(1-5)	(6-11)	(12-up)
3/32"	2.4	100'	21-8750	21-8780	\$10.99	\$8.80	\$7.54
1/16"	4.8	100'	21-8752	-	16.49	12.81	10.98
3/16"	19.0	50'	21-8756	21-8786	41.49	34.17	29.29
1"	25.4	50'	21-8757	-	58.99	50.16	43.00
2"	50.8	50'	21-8759	-	131.00	110.00	95.00
3/32"	2.4	4'	21-8760	21-8790	10.99	8.44	7.24
1/8"	3.2	4'	21-8761	-	11.99	9.23	7.91
3/16"	4.8	4'	21-8762	21-8792	16.49	12.37	10.61
1/4"	6.4	4'	21-8763	21-8793	18.49	15.59	13.36
3/8"	9.5	4'	21-8764	21-8794	22.49	18.46	15.83
1/2"	12.7	4'	21-8765	21-8795	6.35	5.07	4.34
3/4"	19.0	4'	21-8766	21-8796	14.49	11.22	9.62
1"	25.4	4'	21-8767	21-8797	19.49	15.55	13.33
1 1/2"	38.1	4'	-	21-8798	36.99	31.98	27.40
2"	50.8	4'	21-8769	-	49.49	43.21	37.04
3/32"	2.4	6"	21-8770	21-8800	1.71	1.41	1.21
1/8"	3.2	6"	21-8771	21-8801	1.81	1.37	1.18
3/16"	4.8	6"	21-8772	21-8802	1.91	1.54	1.31
1/4"	6.4	6"	21-8773	21-8803	1.91	1.58	1.34
3/8"	9.5	6"	21-8774	21-8804	1.81	1.49	1.28
1/2"	12.7	6"	21-8775	21-8805	2.21	1.85	1.59
3/4"	19.0	6"	21-8776	21-8806	4.74	3.97	3.40
1 1/2"	38.1	6"	21-8778	21-8808	5.85	4.79	4.11
2"	50.8	6"	21-8779	-	4.03	3.30	2.83



3M™ Heat Shrink Splice Connectors

•These connectors are designed for easy wire insertion and correct wire positioning •Made of annealed electrolytic copper for maximum conductivity and mechanical strength •Heat shrink tubing with additional heat activated sealant shrinks to half the original diameter •Moisture resistant



Order #	Color	Size	Pieces per Pack	ONLY
108-4410	Red	22-18 AWG	8	\$4.49
108-4411	Blue	16-14 AWG	8	4.49
108-4412	Yellow	16-14 AWG	6	4.49



3M Heat Shrink Tubing 4' Sections

3M™ Thin Wall Tubing FP-301 is a heat shrinkable flexible polyolefin tubing that offers an outstanding balance of electrical, physical and chemical properties for a wide variety of applications. FP-301 tubing is split resistant, mechanically tough, easily marked and resists cold flow. •UL Recognized and CSA Certified at 600V at 257°F (125°C) •MIL-I-23053/5, Class 1,2. AMS 3636 (Type I) and AMS 3637 (Type II) •Each piece is 48" long •Black color.



Order #	Size (I.D.)	Qty.	ONLY
108-1405	3/4"	12	\$23.99

MCM Heat Shrink Kit

•This kit features high-quality ICO-Rally heat shrink products •127 pieces of the most popular heat shrink sizes and colors •6" length



ICO-RALLY Heat Shrink Kit

•This kit features high quality ICO-Rally heat shrink products •72 pieces of the most popular heat shrink sizes and colors •6" length



Size	Black	Clear	Red	White	Blue	Yellow	Green	Refill #
1/16"	6	4	4	3	3	2	2	95-780
3/32"	6	4	4	3	3	2	2	95-785
1/8"	6	4	4	3	3	2	2	95-790
3/16"	6	4	4	3	3	2	2	95-675
1/4"	6	4	2	2	2	2	2	95-680
3/8"	3	2	2	1	1	1	1	95-685

#102-025\$44.49 (kit)

Size	Black	Clear	Red	White	Blue	Yellow	Green	Refill #
3/16"	6	4	4	3	3	2	2	95-675
1/4"	6	4	2	2	2	2	2	95-680
3/8"	3	2	2	1	1	1	1	95-685
1/2"	2	2	1	1	1	1	1	95-690
3/4"	1	1	1	1	1	-	-	95-695
1"	1	1	1	-	-	-	-	95-700

#102-011\$35.49 (kit)

3M Heat Shrink Tubing Kits and Refill Packs

•Versatile assortment of 6" flexible polyolefin heat shrink tubing with a 2:1 shrink ratio •Available in two different types: Assorted colors or black •Assorted color kit contains a total of 133 pieces, in six different sizes and seven different colors: Black, red, white, yellow, blue, green and clear •Black kit contains 102 pieces, in six different sizes



Order #	Description	ONLY
108-3195	Assorted color kit	\$69.99
108-3202	Black kit	67.99
Assorted color refills		
108-3196	3/32" dia., 35 pcs.	10.49
108-3197	1/8" dia., 28 pcs.	10.49
108-3198	3/16" dia., 21 pcs.	10.49
108-3199	1/4" dia., 21 pcs.	10.49



180 Piece Heat Shrink Kits

A premium-grade flame-retardant polyolefin heat-shrinkable tubing. •Outstanding overall performance, excellent physical and electrical performance, and very flexible to meet a very wide range of uses •Available in 2:1 or 3:1 shrink ratios •Operating temperature -67°F~257°F •Minimum shrink temperature 158°F •Resistant to common fluids and solvents •UL Recognized component •Meets MIL AMS-DTL-23053/5 class 1 and 3 •RoHS compliant •Various colors in kit: Black, red, blue, yellow, and white •2"~ 2 1/4" lengths •1/8", 3/16", 1/4", and 1/2" inner diameter sizes

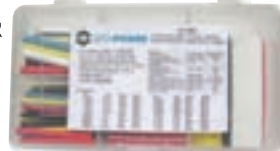

Order #	Description	(1-5)	(6-11)	(12-up)
21-8865	2:1 kit	\$25.49	\$22.73	\$21.64
21-8870	3:1 kit	32.49	28.79	27.52



3M Heat Shrink Tubing Spools

General purpose, flexible polyolefin tubing in 100' rolls is perfect for electrical insulation over connectors, splices and wire bundling. 2:1 shrink ratio. Black in color. UL listed.



Order #	Size (I.D.)	(1-9 spools)	(10 spools-up)
108-3300	1/8"	\$26.49	\$22.23
108-3301	3/16"	31.99	25.94
108-3302	1/4"	37.99	32.43
108-3303	3/8"	41.99	35.22
108-3304	1/2"	46.99	39.86

Need Larger Quantities? Contact Our Quotes Team: 1-800-543-4330 quotes@MCMelectronics.com





Section 10

WIRE & CABLE

HDMI Cables



Premium HDTV Performance Kit

- ✓ 3D-ready HDMI cables with Ethernet channel
- ✓ Real-time content signaling optimizes TV picture settings
- ✓ Premium micro fiber cloth safe on all displays
- ✓ Streak-free cleaner formula safe on all displays

Get high-definition connectivity cables and for your new LCD TV screen clean with this unique HDTV kit. Includes two 6' high speed HDMI cables, 6 oz. Eco-friendly screen cleaning solution and 12" x 12" high tech lint free micro fiber cloth. **[E]**

Order #	MSRP	ONLY
24-10905	\$69.95	\$20.49



6' High Speed HDMI Cable with Ethernet

Get the latest high performance 3D and 4K display technologies and bi-directional audio and data connectivity with v1.4 high-speed HDMI cables. The powerful high-speed HDMI cable supports new capabilities to push the boundaries of your high-definition experience. It's the perfect interconnect for your A/V receiver, high-definition projector, 3D-capable TV, Blue-ray DVD player, and much more. **Features:**

- Retail blister package
- Ethernet channel
- HDMI male-to-male cable with 20# gold-plated connectors
- Oxygen free 28AWG copper wire, foil shield
- Outer diameter: 6.0 mm
- 30V voltage rating, UL20276 CM **[E]**

Order #	MSRP	ONLY
24-10106BP	\$69.95	\$30.49



High Speed HDMI Cable with Ethernet **[UL]**

Take advantage of better looking movies, faster gaming and richer audio with the latest v1.4 high speed HDMI cables. High speed HDMI is compatible with 3D and 4K display technologies, bi-directional audio and data connectivity, and supports new capabilities to push the boundaries of your high-definition experience. It's the perfect interconnect for your A/V receiver, high-definition projector, 3D-capable TV, Blue-ray DVD player, and much more. **Features:**

- Ethernet channel
- HDMI male-to-male cable with 20# gold-plated connectors
- Oxygen free, 30AWG copper wire with foil shield
- Outer diameter: 6.0 mm
- 30V voltage rating, UL20276 CM **[E]**

Order #	Length	MSRP	ONLY
24-10910	3'	\$12.95	\$6.05
24-10912	6'	19.95	8.07
24-10914	15'	24.95	12.49
24-10916	25'	39.95	20.49



Premium High Speed HDMI with Ethernet Cables

The latest in home theater high-performance cables. Suitable for use with A/V receivers, high-definition projectors, set top box, 3D and DVD/PVR/DVR/Blu-Ray support. **Specifications:** HDMI to HDMI, blue metal hooded, gold-plated connectors, with 30 AWG oxygen free conductors and copper foil shielding. High-resolution support of 3840 x 2160 (24Hz; 25Hz; 30Hz) and 4096 x 2160 (24Hz). Black nylon braid on a black PVC (CL2) in-wall jacket; 6.0 mm OD; 30V voltage rating; UL20276. **[E]**

Order #	Length	MSRP	ONLY
24-10170	3'	\$49.95	\$12.49
24-10172	6'	59.95	16.49
24-10174	12'	79.95	20.49
24-10176	25'	99.95	23.49



High-Speed Swivel-type HDMI with Ethernet

Be ready for emerging all-digital, high-bandwidth, deep color graphics, and system-intelligent bi-directional communications with the latest v1.4 high-speed HDMI cables. High-speed HDMI is compatible with 3D and 4K display technologies, bi-directional A/V and data connectivity, and supports faster refresh rates like 120Hz pushing the boundaries of your high-definition experience. **Features:**

- Special swivel-type HDMI male connectors ideal for tight installations
- Ethernet channel
- 20# gold-plated connectors
- Oxygen free, 30AWG copper wire with foil shield
- Outer diameter: 6.0 mm
- 30V voltage rating, UL20276 CM **[E]**

Order #	Length	MSRP	ONLY
24-10920	1.5'	\$14.95	\$7.06
24-10922	3'	24.95	12.49
24-10924	6'	29.95	16.49
24-10926	15'	39.95	17.49



High Speed HDMI to DVI-I Cables

These adapters are ideal for connecting your DVI-enabled HDTV display devices and HDMI digital video sources. Impedance matched and multi-layered EMI/RFI protection reduces cross-talk and ensures the best video signal possible. Compatible with the newest 3D and 4K resolution enhancements. **[E]**

Order #	Length	MSRP	ONLY
24-11050	6'	\$15.95	\$8.07
24-11052	15'	17.95	9.08
24-11054	25'	24.95	13.49



3' Micro HDMI High-Speed Cable

Connect your smart phone or other HDMI-enabled mobile device with this Micro-HDMI cable. Supports high-speed HDMI functionality; 10.2Gbps data rate, ethernet over HDMI, 4k x 2k support, audio return channel, 3D and deep color support. **[E]**

Order #	ONLY
24-10900	\$10.49



High Speed T-Lock HDMI with Ethernet

Featuring a single-point thumb-screw lock these hassle-free high speed HDMI cables are designed to replace the single retaining screw on most HDMI jacks and stay attached for good. Compatible with 3D and 4K display technologies, bi-directional A/V and data connectivity, and supporting the faster refresh rates like 120Hz, these cables help you push the boundaries of your high-definition experience. **Features:**

- Ethernet channel
- 20# gold-plated connectors
- Oxygen free, 30-28AWG copper wire with foil shield
- Outer diameter: 6.0 mm
- 30V voltage rating, UL20276 CM **[E]**

Order #	Length	MSRP	ONLY
24-10930	3'	\$19.95	\$10.49
24-10932	6'	24.95	13.49
24-10934	15'	29.95	15.49
24-10936	25'	34.95	17.49



DVI Cables

MCM is your source for high-quality DVI cables and adapters. MCM offers a wide range

of DVI and DFP cables featuring single and dual link DVI-I, DVI-D and DFP connectors. They are fully recognized by the Digital Display Working Group (DDWG) which means you are getting a quality tested cable guaranteed to provide optimal DVI video reproduction. They are ideal for connecting all your DVI equipment, including LCD panels, digital projectors, plasma screen and HDTV systems. All cables are beige and feature a limited lifetime warranty to be free from defects in materials and workmanship. **[E]**

Order #	Length	ONLY	Order #	Length	ONLY
DVI-D male/male dual link			DVI-I male/male dual link		
83-9953	1M	\$13.49	83-9959	1M	\$13.49
83-9954	2M	15.49	83-9960	2M	15.49
83-9955	5M	13.49	83-9961	5M	18.99
24-9322	8M	49.49			
DVI-D dual link extension					
83-9965	1M	13.49			
83-9966	2M	15.49			

HDMI Cables



High Speed Inwall HDMI with Ethernet

Take advantage of the latest high performance 3D and 4K display technologies and bi-directional audio and data connectivity with v1.4 high-speed HDMI cables. These CL3 rated inwall cables allow you to tackle any professional installation with confidence. **Features:** •Ethernet channel •20# gold-plated connectors •Oxygen free, 30~26AWG copper wire with foil shield •Outer diameter: 6.0 mm •30V voltage rating, UL20276 CL3

White	Blue	Orange	Red	Length	MSRP	ONLY
24-10940	24-10950	24-10960	24-10970	3'	\$16.95	\$8.07
24-10942	24-10952	24-10962	24-10972	6'	24.95	13.49
24-10944	24-10954	24-10964	24-10974	15'	29.95	14.49
24-10946	24-10956	24-10966	24-10976	25'	49.95	22.49
24-10948	24-10958	24-10968	24-10978	50'	69.95	34.49

Mini Type "C" Male HDMI to Female HDMI Adapter

•Type "C" HDMI is used in most digital camcorders that utilize HDMI for video output
•Allows for usage of standard HDMI cable



Order #	MSRP	ONLY
24-10544	\$14.99	\$9.08



6' High Speed HDMI Adapting Cable

Delivers clean, uncompressed digital signals and supports 3D and 4K display technologies, bi-directional A/V and data connectivity, and 120Hz refresh rates. **Features:** •Ethernet channel compatible •Multi-layer shielding to prevent EMI/RFI •20# gold-plated connectors •30V voltage rating

Order #	Description	MSRP	ONLY
24-11030	Right-angle swivel	\$19.95	\$10.49
24-11035	HDMI A to micro D	19.95	10.49
24-11040	HDMI A to mini	19.95	10.49

Display Port Adapters



DisplayPort Adapters

Designed to meet DisplayPort standards, these adapters are available in both latching and non-latched models. **Note:** DisplayPort does not currently pass an audio signal.

Fig. Order #	Description	ONLY
Latching		
A 83-11675	DisplayPort male to DVI female	\$17.99
Non-latching		
B 83-11676	DisplayPort male to HDMI female	10.49
C 83-11677	DisplayPort male to DVI female	10.49



WIRE & CABLE



Section 10



High Speed Flat HDMI with Ethernet

Take advantage of 3D and 4K display technologies, bi-directional A/V and data connectivity, and faster refresh rates with the newest high-speed HDMI cables. These flat, low-profile cables are flexible and well suited for inwall installations. **Features:** •Special flat HDMI straight or right-angle male connectors ideal for tight installations •Ethernet channel •20# gold-plated connectors •Oxygen free, 28~24AWG copper wire with foil shield •Diameter: 3.0 mm thick •30V voltage rating, UL20276 CL3

Order #	Length	MSRP	ONLY
Straight			
24-10980	3'	\$19.95	\$9.08
24-10982	6'	29.95	14.49
24-10984	15'	32.95	16.49
24-10986	25'	43.95	22.49
Right-Angle			
24-10990	3'	19.95	9.08
24-10992	6'	29.95	14.49
24-10994	15'	32.95	16.49
24-10996	25'	43.95	22.49

HDMI™ Active Equalizing Extender

Active coupler provides double female connection (A/A), allowing two HDMI™ cables to be combined for up to 100' total length. **Features:** •Uses external power supply (included) to equalize and extend the HDMI™ signal •Status indicator LEDs •Compatible with HDMI™ Version 1.3a •HDCP (High-Bandwidth Digital Content Protection) complaint •Supports 1080p to 82', 1080i to 100' •Compatible with computer resolutions through UXGA



Order #	ONLY
33-10500	\$35.49



High Speed HDMI Repeater Cables with Ethernet

Specifically designed for long distance HDMI connectivity these repeater cables reassemble the HDMI HDCP signals to prevent signal loss. Compatible with 3D and 4K display technologies, bi-directional A/V and data connectivity, and 120Hz refresh rates. **Features:** •Inline repeater construction •Ethernet channel •20# gold-plated connectors •Oxygen free, 26AWG copper wire with foil shield •Diameter: 7.0 mm thick •30V voltage rating, UL20276 CL3

Order #	Length	MSRP	ONLY
24-11000	75'	\$129.00	\$70.99
24-11005	100'	159.00	80.99

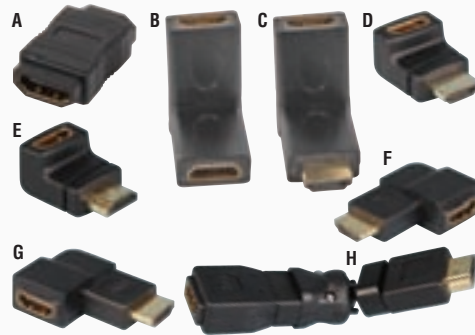

High Speed HDMI Couplers and Adapters

Precision engineered passive high speed HDMI couplers can be used to reposition the HDMI plug for a better fit, or adapt from one HDMI connection to another. Compatible with 3D and 4K display technologies, bi-directional A/V and data connectivity, and 120Hz refresh rates. **Features:** •Ethernet channel compatible •Multi-layer shielding to prevent EMI/RFI •20# gold-plated connectors •30V voltage rating.

Fig. Order #	Orientation	MSRP	ONLY
A 24-11010	Straight-thru F/F coupler	\$15.95	\$8.07
B 24-11015	Straight-thru F/F swivel coupler	17.95	9.08
C 24-11016	Straight-thru M/F swivel coupler	17.95	9.08
D 24-11020	Upward M/F coupler	15.95	8.07
E 24-11021	Downward M/F coupler	15.95	8.07
F 24-11022	Left-side M/F coupler	15.95	8.07
G 24-11023	Right-side M/F coupler	15.95	8.07
H 24-11025	360° M/F rotating coupler	17.95	9.08



High Speed HDMI to DVI Adapter

These adapters are ideal for connecting High Definition set top boxes to components with HDMI inputs. HDMI-to-DVI adapters are 100% backward compatible with DVI (**Note:** DVI does not pass audio signal). **Features:** 24-karat gold-plated connectors, multi-layer shielding to reduce EMI/RFI, crystal-clear digital quality, and simplified interconnect installation.

Order #	Description	MSRP	ONLY
24-11045	HDMI male to DVI-I female	\$17.95	\$9.08
24-11046	HDMI male to DVI-I female	17.95	9.08



WIRE & CABLE

Section 10



Standard HDMI



HDMI v1.3 High-Speed Cables

Just what you need to take advantage of full high-definition audio and video signals •Specially designed to support HDMI v1.3, high-speed, Cat 2 requirements

Specifications: •24K gold-plated connectors •Supports single-link bandwidth of 340MHz (10.2 Gbps) •High resolution support (full 1080p at up to 120Hz refresh and WQXGA) •CEC system control support •Fully HDCP compliant

Order #	Length	MSRP	ONLY
24-10100	3'	\$19.95	\$5.65
24-10105	6'	24.95	8.07
24-10110	10'	39.95	11.49
24-10115	25'	69.95	20.49

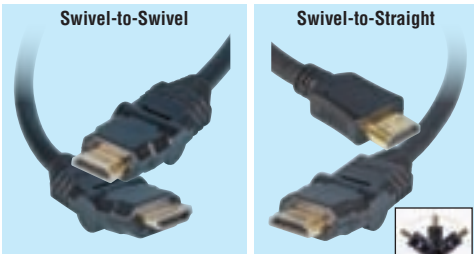

HDMI v1.3 Swivel Cable

•Right-angle swivel connectors stay connected better by rotating a full 180° to facilitate installation in tight spaces behind source equipment •Reduces directional strain on cable •Low 1/4" profile from connection

•HDMI v1.3 certified •28AWG •Gold-plated connectors

•Triple shielding •10.2 Gbit/s bandwidth •Deep color, 120Hz frame rate, 1080P resolution, and lossless audio capable •7mm (O.D.)

Order #	Length	MSRP	ONLY
Swivel-to-swivel			
24-10496	3'	\$24.95	\$11.49
24-10497	6'	34.95	15.99
24-10499	25'	79.95	22.99
Swivel-to-straight			
24-10500	1.5'	17.95	6.86
24-10501	3'	24.95	11.49
24-10502	6'	34.95	15.99
24-10503	10'	49.95	17.49



SONY. HDMI v1.3 Swivel Cable

•Unique top-to-bottom, or side-to-side swivel design for flexible cable connection to display from source components •Swing angle: ±90° degrees off center and locks at each 45° measure •High-speed v1.3a (Category 2) certified •Supports up to 1080p (full-HD) resolution •24K gold-plated connectors

Order #	Orientation	Length	ONLY
DLCHD10V	Side-to-side	1m	\$33.49
DLCHD20V	Side-to-side	2m	38.49

HDMI™ Cable Couplers

These passive HDMI™ female-to-female couplers allow you to extend two HDMI™ cables for a combined length of 50' •Features: •Compatible with HDMI™ Version 1.3a •HDCP (High Definition Copy Protocol) compliant •Supports 1080p and 1080i up to 50' •Compatible with computer resolutions through UXGA

Order #	Description	ONLY
33-10505	HDMI A/A jacks	\$10.49
33-10506	HDMI A/C jacks	10.49



HDMI Adapters

Designed to meet rigid and demanding HDMI compliant standards, these adapters are ideal for connecting high definition set top boxes to components with HDMI inputs. HDMI to DVI adapters are 100% backward compatible with DVI (Note: DVI does not pass audio signal). •Features: 24-karat gold-plated connectors, multi-layer shielding to reduce EMI/RFI, crystal-clear digital quality and simplified interconnect installation.

Order #	Description	MSRP	ONLY
24-9345	HDMI male to DVI female adapter	\$44.95	\$8.57
24-9350	HDMI female to DVI male adapter	44.95	8.57



HDMI/DVI Swivel Adapters

•Adapt from HDMI to DVI, or vice-versa with a convenient swivel design

•Dual-axis swivel bends 180° up or down, and twists 360° •Eliminate strain from bulky standard adapters.

Description	MSRP	ONLY
HDMI female to DVI male		
24-10140	\$29.99	\$11.49
DVI female to HDMI male		
24-10142	29.99	11.49



Order #	Right Angle Orientation	(1-4)	(5-9)	(10-up)
24-10335	Upward	\$6.96	\$5.14	\$4.84
24-10336	Downward	6.96	5.14	4.84
24-10337	Left-side	6.96	5.14	4.84

SVGA Cables



Super VGA Cables

These heavy-duty cables are designed to extend your existing video cable up to 100' with minimal signal loss. Use when installing switch boxes or extenders. •Rating: UL2990 •Double-shielded

Order #	Description	(1-9)	(10-up)
83-12234	1' HD-15 male to female	\$7.06	\$6.53
83-12235	3' HD-15 male to female	8.07	7.46
83-7849	6' HD-15 male to female	10.49	9.34
83-7850	10' HD-15 male to female	13.49	12.37
83-7851	15' HD-15 male to female	16.49	15.44
83-7852	25' HD-15 male to female	23.49	22.78
83-7853	50' HD-15 male to female	33.49	32.88
83-7854	75' HD-15 male to female	45.49	42.98
83-7855	100' HD-15 male to female	50.49	48.03
83-12236	1' HD-15 male to male	7.06	6.53
83-12237	3' HD-15 male to male	8.07	7.46
83-7856	6' HD-15 male to male	10.49	9.34
83-7857	10' HD-15 male to male	13.49	12.37
83-7858	15' HD-15 male to male	16.49	15.44
83-7859	25' HD-15 male to male	23.49	22.78
83-7860	50' HD-15 male to male	33.49	32.88
83-7861	75' HD-15 male to male	45.49	42.98
83-7862	100' HD-15 male to male	50.49	48.03



SVGA with 3.5mm Cables

These heavy-duty cables are designed to extend your video and audio up to 100' from your PC with minimal signal loss. These cables have a HD-15 M/1' 3.5mm lead with plug on one end and a HD-15M/2' 3.5mm lead with plug on the other. They also include a molded ferrite core to reduce EMI interference.

Order #	Description	ONLY
83-11360	6' HD15 M/M + 3.5mm	\$10.49
83-11361	10' HD15 M/M + 3.5mm	13.49
83-11362	15' HD15 M/M + 3.5mm	16.49
83-11363	25' HD15 M/M + 3.5mm	23.49
83-11364	50' HD15 M/M + 3.5mm	33.49
83-11365	75' HD15 M/M + 3.5mm	45.49
83-11366	100' HD15 M/M + 3.5mm	50.49



VGA to Dual VGA Adapter

•Turn one VGA output into multiple video outputs

•HD-15 VGA to two HD15 VGA outputs

•This unique adapter splits a VGA output into two video outputs

Order #	ONLY
83-11680	\$6.99

Stellar Labs™ HDMI v1.3 Right Angle Adapters

Use to reposition cable jack for easy access where space is limited. Delivers clean, uncompressed digital signals and supports high-definition resolutions up to 1080p and UXGA. Features include 24K gold-plated male to female connectors, and multi-layer shielding to reduce EMI/RFI. Unique ball-joint swivel adapter accommodates multi-directional orientation.

Order #	Right Angle Orientation	(1-4)	(5-9)	(10-up)
24-10338	Right-side	\$6.96	\$5.14	\$4.84
24-10339	Multi-directional swivel	8.07	7.20	6.29

Component Video Cables



Stellar Labs™

4' BNC to RCA Component Video Cable

This cable is typically used for short-distance interconnects within mobile multi-media projector cabinets or head-end video patch panels. **Features:**
 •Bonded, tangle-free construction •Low-loss EMI/RFI shielded 75ohm video coaxial wire •Corrosion resistant gold plated connectors

Order #	MSRP	ONLY
24-10545	\$24.95	\$18.99

Four Connections BNC Male to BNC Male



BNC male connectors color coded: Red, green, blue and black for red, green, blue and horizontal video inputs on each end. 6' length.

Order #	(1-9)	(10-49)
83-3190	\$32.49	\$27.28

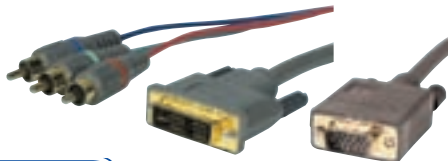

Stellar Labs™

Component Video Cables

Connect your component video device to the VGA or DVI input connector on HDTV compatible displays. **Note:** The video display with a "VGA" or "DVI-I" connector needs to support component video (Y-Pr-Pb) in order to properly synchronize.

Order #	Length	MSRP	(1-9)	(10-up)
3RCA to HD15				
24-9450	1½'	\$11.95	\$6.05	\$3.88
24-9451	3'	17.95	10.49	7.03
24-9452	6'	23.95	13.49	8.43
24-9453	12'	23.95	13.49	8.54
24-9454	25'	42.95	24.49	14.57
24-9455	50'	72.95	43.49	29.88
24-9456	75'	99.95	57.99	36.91
3RCA to DVI-I				
24-9460	3'	22.95	13.99	9.26
24-9461	6'	28.95	17.49	10.91
24-9462	12'	32.95	20.49	11.52
24-9463	25'	46.95	27.49	18.53

DVI to Component Adapter

•Turn one DVI output into multiple video outputs •DVI to component + HD-15 •This unique adapter splits a DVI output into two video outputs

Order #	ONLY
83-11678	\$8.07



Stellar Labs™

Component Video Cables

•Bonded, tangle-free construction •EMI/RFI shielded, low-loss, 75ohm video coaxial wire helps reduce interference and noise, and accurately separate the component color signal (Y-Pr-Pb) for better resolution and greatly improved color saturation •Long-lasting, corrosion resistant, gold plated barrel connectors with fully over-molded, custom tooled strain reliefs
 •Color-coded connectors for easy identification

Order #	Length	MSRP	ONLY
24-9430	1½'	\$10.95	\$7.06
24-9431	3'	14.95	8.07
24-9432	6'	18.95	11.99
24-9433	12'	26.95	14.49
24-9434	25'	42.95	19.49
24-9435	50'	84.95	30.49
24-9436	75'	119.00	50.49
24-9437	100'	149.00	50.49
24-9438	150'	189.00	80.99

Stellar Labs™

Premium Component Video Cables

Precision engineered to provide superior picture quality and excellent signal integrity. **Features:** •Oxygen free coaxial copper construction •Tangle free bonded wires •Gold plated, corrosion free split-lock ring RCA connectors •UL listed •Limited lifetime warranty

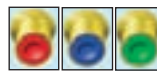

Order #	Length	MSRP	ONLY
24-8891	3'	\$59.95	\$18.49
24-8892	6'	65.95	22.49
24-8893	9'	80.95	25.49
24-8894	12'	85.95	30.49
24-8895	25'	119.00	34.49
24-8896	50'	159.00	40.49
24-8897	75'	299.00	50.49
24-8898	100'	399.00	60.99

WIRE & CABLE



Section
10



Stellar Labs™

Component Video and Stereo Audio Cables

Features: •EMI/RFI shielded, low-loss, 75ohm video coaxial wire helps reduce interference and accurately separate the component color signal (Y-Pr-Pb) for better resolution and greatly improved color saturation •Oxygen-free copper wires produce crisp, clear audio signal transfer •Long-lasting, corrosion resistant, gold plated barrel connectors with fully over-molded, custom tooled strain reliefs •Color-coded connectors for easy identification.

Order #	Length	MSRP	ONLY
24-9440	1½'	\$19.95	\$10.49
24-9441	3'	25.95	13.49
24-9442	6'	27.95	15.49
24-9443	12'	54.95	17.49
24-9444	25'	65.95	25.49
24-9445	50'	88.95	36.49

Component Video Cables

Component video cables made from RG-59U coaxial cable. Color coded strain reliefs for quick identification (red/green/blue).

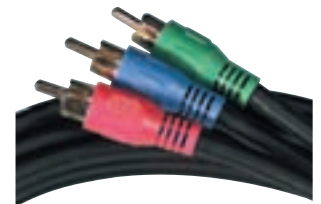

Order #	Length	ONLY
Gold Plated		
24-4565	3'	\$2.99
24-4570	6'	4.99
24-4575	10'	7.99
24-4580	15'	9.99
Nickel Plated		
24-4540	3'	2.99
24-4545	6'	4.99
24-4555	15'	9.99
24-4560	25'	13.99

Stellar Labs™ HDTV Premium Cable Kit

The most popular 6' cables used in virtually all HDTV connections. Great all-in-one solution for connecting your HDTV home theater system. Kit includes one each of the following: HDMI cable, component video/toslink audio cable assembly, composite video/stereo audio cable assembly, S-video cable and an HDMI/female-to-DVI-I male adapter. Limited life-time warranty.

Order #	ONLY
24-10450	\$21.99





WIRE & CABLE

Section 10

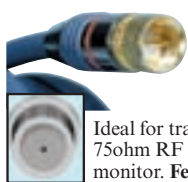

Stellar Labs™

Premium "F" Type Coaxial Cables

Ideal for transporting cable TV, DSS or 75ohm RF antenna signals to your TV, or monitor. **Features:** •UL listed wire •7.0mm outer diameter •Dual EMI/RFI shielding

•Thick polyethylene dielectric •OFC conductors •Screw-lock "F" type connectors feature gold-plated, corrosion free construction to further reduce interference and attenuation •Limited lifetime warranty

Order #	Length	MSRP	(1-10)	(11-50)	(51-up)
RG-6					
24-8920	1.5'	\$12.95	\$6.05	-	-
24-8921	3'	14.95	7.06	-	-
24-8922	6'	16.95	7.06	-	-
24-8924	12'	19.95	7.06	-	-
24-8925	25'	24.95	9.08	-	-
24-8926	50'	29.95	14.49	-	-
Mini Coax					
24-8930	1.5'	10.95	7.36	\$5.87	\$5.50
24-8935	25'	19.95	13.49	7.81	7.40
24-8936	50'	24.95	19.49	11.17	10.47



Bulk Screw Type RF Cables

Save money by purchasing your audio/video cables in bulk. These cables are available 20 per package for

home theater installation or use to give away when doing service calls. 75ohm cable with screw on "F" connectors on each end.

Order #	Length	Price per Cable	ONLY
24-2515	3'	\$1.27	\$25.49
24-2520	6'	1.82	36.49
24-2525	10'	2.17	43.49



Push On "F" to "F" Jumper Cables

•High-quality coaxial cable •75ohm •RG-59 •Molded strain relief •Nickel plated •Male connectors

Order #	Length	(1-9)	(10-49)	(50-up)
Nickel Plated				
32-3675	3'	\$2.72	\$1.79	-
32-3680	6'	6.05	5.18	-
Gold Plated				
32-600	3'	6.76	5.60	\$5.09
32-605	6'	9.08	6.23	-
32-607	12'	9.89	7.94	6.59



Right Angle Push On "F" to "F" Jumper Cables

•Right angle connectors on both ends for use where space is limited •High quality, 75ohm RG-59 cable •Molded strain relief

Order #	Length	(1-9)	(10-up)
32-930	3'	\$3.22	\$2.09
32-935	6'	4.53	3.08



White RF Patch Cables

75ohm patch cables with male "F" connectors at each end. White jacket to blend with decor inside as well as outside the house.

Order #	Length	(1-9)	(10-49)	(50-up)
24-2545	3'	\$4.53	-	-
24-2550	6'	5.65	-	-
24-2555	10'	6.66	\$5.28	\$3.44
24-2560	25'	6.66	5.26	4.80
24-2565	50'	15.49	12.59	12.04



"F" to "F" Patch Cables

•High quality jumper cables •75ohm •Ideal for cable, TV, and

Order #	Length	(1-9)	(10-up)
VCR connections •Male connectors			
Gold plated			
32-580	3'	\$3.02	\$2.61
32-585	6'	4.03	2.95
Nickel plated			
33-544	3'	1.81	-
33-548	6'	2.21	-
33-1150	12'	2.82	-
33-4030	25'	4.43	-
33-4035	50'	7.77	-

#24-9000



Stellar Labs™

SLV Series S-Video Splitting Cable

Allows you to split the chrominance and luminance signals over standard coaxial cable. Minimize signal loss and maximize cable run length.

#24-9005



For best performance, be sure to keep coaxial cables the same length and free from kinks. Must be purchased in pairs.

Order #	Description	MSRP	ONLY
24-9000	1' S-video to 2 BNC(f) splitter	\$9.95	\$7.06
24-9005	6' S-video to 2 "F" type(m) splitter	9.95	7.06



USB Cables and Adapters

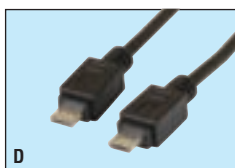
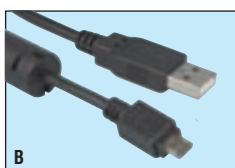
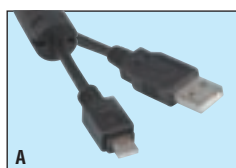

USB 2.0 A/B Cables

✓High speed 480Mb cables
✓Used for many USB connections

Order #	Color	Length	(1-9)	(10-up)
83-10676	Beige	3'	\$4.03	\$2.66
83-10677	Beige	6'	5.04	3.57
83-10678	Beige	10'	6.05	5.50
83-10679	Beige	15'	8.07	6.92
83-10680	Black	3'	4.03	2.89
83-10681	Black	6'	5.04	3.57
83-10682	Black	10'	6.05	6.01
83-10683	Black	15'	8.07	6.92



Mini USB A/B Cables

•USB A male to mini USB connector •Both mini 5 pin and mini 4 pin styles available •High speed up to 480Mb cables •Used for many USB connections •Cable color is black

Order #	Cable Type	Length	(1-9)	(10-up)
83-10704	USB A/mini 4 pin	6'	\$2.62	\$2.31
83-10705	USB A/mini 5 pin	3'	3.02	2.70
83-10706	USB A/mini 5 pin	6'	5.04	4.29
83-10718	USB A/mini 8 pin flat for Nikon®/Sanyo® cameras	6'	3.42	3.15
83-10719	USB A/mini 8 pin curved for Nikon® cameras	6'	3.42	2.88

USB Gender Changers

 USB AF to BM Order # ONLY 83-11352 \$3.12	 USB AM to BF Order # ONLY 83-11353 \$3.12	 USB AF to BF Order # ONLY 83-11354 \$3.12	 USB BF to Micro BM Order # ONLY 83-11873 \$3.12	 USB Micro ABF to BM Order # ONLY 83-11874 \$3.12
 USB AM to AM Order # ONLY 83-11356 \$3.12	 USB AF to AF Order # ONLY 83-11357 \$3.12	 USB BM to BM Order # ONLY 83-11358 \$3.12	 USB BF to BF Order # ONLY 83-11359 \$3.12	 USB Mini 5 Pin to Micro BM Order # ONLY 83-11875 \$3.12

Micro USB 2.0 Cables

Fig.	Order #	Length	(1-9)	(10-up)
USB A Male to USB Micro A Male				
A	83-11870	6'	\$4.13	\$3.35
A	83-11622	9'	6.25	6.07
USB A Male to USB Micro B Male				
B	83-11869	6'	4.13	3.35
B	83-11625	9'	6.25	6.07
USB Micro B male to USB Micro AB Female				
C	83-11871	6'	4.13	3.35
USB Micro B Male to USB Micro A Male				
D	83-11872	6'	3.12	2.32

S-Video Cables

Stellar Labs™

Premium S-Video Cables

Twisted pair, oxygen free coaxial copper construction provides the ideal media for separating and transporting color and brightness signals. **Features:** •Dual EMI/RFI shielding •Tangle free bonded wires •Gold plated corrosion free shielded S-video connectors. •UL listed wire •Limited lifetime warranty

Order #	Length	MSRP	ONLY
24-8821	3'	\$46.95	\$5.65
24-8822	6'	48.95	6.96
24-8823	9'	64.95	8.07
24-8825	25'	78.95	14.99
24-8826	50'	119.00	19.49
24-8827	75'	149.00	25.49
24-8828	100'	169.00	28.49
24-8829	150'	189.00	40.49

Gold Plated S-Video Jumper Cables

For use in any number of video applications including DVDs, S-VHS VCRs, DBS satellite receivers and video games. High quality cables with molded strain reliefs and gold connectors.

Order #	Length	(ea.)	(2-4)
32-1205	6'	\$7.06	\$5.76
32-1210	12'	12.99	9.36
32-3845	24'	16.99	12.15
24-7335	50'	33.49	26.73
24-7340	100'	14.99	-

MCM

Bulk S-Video Cables

Save money by purchasing your S-video cables in bulk. These cables are available 20 per package for home theater installations or use to give away when doing service calls.

Order #	Length	ONLY
24-6365	6'	\$109.00
24-6370	12'	124.00
24-6375	25'	182.00

MCM

S-Video Splitters

Useful for sharing one S-video source to two monitors or recorders. Not recommended for using two sources on one input.

Order #	Description	(ea.)	(2-4)	(5-up)
24-7830	1 male to 2 female	\$8.17	\$7.93	\$7.73
24-7835	1 female to 2 male	8.78	8.11	7.14

Female to Female S-Video Connector

•Connects two S-video cables together

Order #	ONLY
27-1270	\$2.31

WIRE & CABLE



Section
10

Stellar Labs™

S-Video Cables

•Bonded, tangle-free construction •Individually shielded, low-loss, dual 75ohm video coaxial conductors, which separate color and brightness signals to maximize video signal transfer •Long-lasting, corrosion resistant, gold plated barrel connectors with fully over-molded, custom tooled strain relief.

Order #	Length	MSRP	ONLY
24-9360	1½'	\$7.99	\$4.03
24-9361	3'	8.99	4.53
24-9362	6'	11.95	5.65
24-9363	12'	13.95	7.06
24-9364	25'	26.95	12.99
24-9365	50'	42.95	19.49
24-9366	75'	59.95	24.49
24-9367	100'	68.95	30.49
24-9368	150'	99.95	34.49

Stellar Labs™

S-Video "Y" Splitting Cables

•4 pin DIN male to two 4 pin DIN male

Order #	Length	MSRP	ONLY
24-9370	1½'	\$8.99	\$2.31
24-9371	3'	9.99	4.53
24-9372	6'	12.95	5.65
24-9373	12'	15.95	7.06
24-9374	25'	29.95	10.49

Composite and A/V Cables

Stellar Labs™

Composite/S-Video and Stereo Audio Cables

•Bonded, tangle-free construction •EMI/RFI shielded, low-loss, dual conductor 75ohm coax S-video wire to deliver high-resolution video images •Color-coded composite video 75ohm coaxial cable •Dual 26AWG shielded audio wires protect against noise and distortion •Color-coded red and white RCA audio connectors

Order #	Length	MSRP	ONLY
24-9390	1½'	\$10.95	\$5.54
24-9391	3'	12.95	7.06
24-9392	6'	22.95	9.08
24-9393	12'	28.95	11.49
24-9394	25'	39.95	20.49
24-9395	50'	54.95	24.49

Stellar Labs™

Premium S-Video to Composite Video Cables

Convert S-video signals into a composite video format for use on display equipment without S-video connections. **Features:** •Dual EMI/RFI shielding •Tangle free bonded wires •Gold plated corrosion free shielded S-video connectors •Secure split-lock ring composite video RCA connectors •Limited lifetime warranty.

Order #	Length	MSRP	(1-10)	(11-50)	(51-up)
24-8852	6'	\$21.95	\$9.28	\$8.90	\$8.62
24-8853	9'	22.95	9.28	8.76	8.47
24-8854	12'	25.95	11.49	10.72	10.37
24-8855	25'	26.95	15.49	14.92	14.44

Stellar Labs™

Premium Composite Video Cables

Ideal for long cable runs where EMI/RFI shielding and signal integrity are crucial. •UL listed wire •Limited lifetime warranty

Order #	Length	MSRP	(1-10)	(11-50)	(51-up)
24-8871	3'	\$18.95	\$8.07	\$6.80	\$6.59
24-8872	6'	18.95	10.49	9.25	8.68
24-8873	9'	19.95	10.49	8.76	8.47
24-8874	12'	18.95	11.49	9.74	9.42
24-8875	25'	29.95	18.49	15.60	15.11
24-8876	50'	29.95	17.99	13.38	12.55
24-8877	75'	42.95	30.49	25.39	24.59
24-8878	100'	49.95	34.49	29.31	28.38
24-8879	150'	68.95	45.49	39.10	37.85

Stellar Labs™

S-Video and Stereo Audio Cables

•Bonded, tangle-free construction •Dual 26AWG shielded audio wires to protect against noise and distortion •EMI/RFI shielded, low-loss, dual conductor 75ohm coax S-video wire •Color-coded red and white RCA audio connectors •Male 4 pin DIN S-video to male RCA composite video

Order #	Length	MSRP	ONLY
24-9401	3'	\$14.95	\$4.53
24-9402	6'	18.95	5.65
24-9403	12'	23.95	7.77
24-9404	25'	39.95	10.49
24-9405	50'	49.95	13.99

Stellar Labs™

S-Video Plus Stereo Audio Cables

•Bonded, tangle-free construction •EMI/RFI shielded, low-loss, dual conductor 75ohm coax S-video wire to deliver high-resolution video images •Dual 26AWG shielded audio cables protect against noise and distortion •Color-coded red and white RCA audio connectors.

Order #	Length	MSRP	ONLY
24-9380	1½'	\$10.95	\$4.53
24-9381	3'	12.95	7.06
24-9382	6'	18.95	7.06
24-9383	12'	19.95	8.07
24-9384	25'	29.95	13.49
24-9385	50'	49.95	19.49

Stellar Labs™

Composite Video Cables

•Bonded, tangle-free construction •EMI/RFI shielded, low-loss, 75ohm video coaxial wire helps reduce interference and improve resolution, color and brightness •Long-lasting, corrosion resistant, gold plated barrel connectors with fully over-molded, custom tooled strain reliefs •Color-coded connectors for easy identification

Order #	Length	MSRP	ONLY
24-9410	1½'	\$6.99	\$3.02
24-9411	3'	8.99	3.12
24-9412	6'	11.95	4.84
24-9413	12'	13.95	5.44
24-9414	25'	29.95	11.49
24-9415	50'	44.95	17.49
24-9416	75'	62.95	20.49
24-9417	100'	78.95	32.99

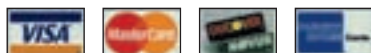



Section 10

WIRE & CABLE

A/V Patch Cables

Audio Patch Cables

Composite Video Cables



BNC Patch Cables

Molded strain reliefs to ensure long life. Male BNC connectors on each end. Perfect for use with professional video equipment and closed circuit television (CCTV) applications.

Order #	Length	ONLY
75ohm		
24-1605	1'	\$5.85
24-1610	3'	5.65
24-1615	6'	6.25
24-1620	10'	6.25
24-5350	25'	17.49
24-1625	50'	19.49
24-1630	100'	25.49
50ohm		
24-1455	1'	5.44
24-785	3'	6.35
24-790	6'	7.06
24-795	12'	7.67
24-1515	30'	14.49



RCA to RCA Patch Cables

Made of high-quality, 75ohm RG-59 cable. Molded strain relief. Male connectors.

Order #	Length	ONLY
Gold Plated		
32-5265	1'	\$2.21
32-5275	2'	2.82
32-590	3'	2.31
32-595	6'	3.52
32-597	12'	2.82
32-4500	25'	7.06
32-4505	50'	12.49
Nickel Plated		
32-5270	1'	2.11
32-5280	2'	2.21
32-4540	3'	2.21
32-4545	6'	2.72
32-4550	10'	3.52
32-4555	25'	5.04
32-4560	50'	8.07



Fully Shielded Cables with Insulated Gold Connectors

These attractive cables offer the very best in signal quality and style designed around our #50-2130 gold plated insulated connectors. These cables feature 100% shielded pure copper braiding with shielded center conductors, wrapped in a midnight blue outer jacket with silver connectors. 6mm diameter. Sold in pairs. Limited quantities.

Order #	Length	(1-9 prs.)	(10-49 prs.)	(50 prs.-up)
50-2160	6'	\$15.99	\$13.48	\$12.04
50-2165	12'	19.99	16.61	14.95



RG-59 Cable Extensions

10' extension. 75ohm. Male connectors.

Order #	Type	ONLY
33-530	BNC to RCA (shown)	\$7.06
33-540	RCA to RCA	6.05



Stellar Labs™

Composite Video and Stereo Audio Cables

Bonded, tangle-free construction. EMI/RFI shielded, low-loss, 75ohm video coaxial wire helps reduce interference and noise, and improve resolution, color and brightness. Long-lasting, corrosion resistant, gold plated barrel connectors with fully over-molded, custom tooled strain reliefs. Color-coded connectors for easy identification.

Order #	Length	MSRP	ONLY
24-9420	1½'	\$11.95	\$5.04
24-9421	3'	15.95	6.25
24-9422	6'	16.95	6.86
24-9423	12'	23.95	9.08
24-9424	25'	42.95	14.49
24-9425	50'	56.95	20.99

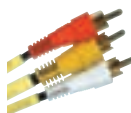

Stereo VCR Patch Cables

Used for dubbing on stereo VCRs. Triple cable with shielded RG-59U coaxial cable for video. RCA male connectors.

Order #	Length	ONLY
Gold Plated		
24-4650	1'	\$3.42
24-4655	2'	4.03
32-960	3'	4.84
32-965	6'	5.54
32-4535	12'	7.26
24-5320	25'	16.49
24-5325	50'	24.49
Nickel Plated		
24-4640	1'	2.92
24-4645	2'	3.32
32-4670	3'	3.63
32-4675	6'	4.53
32-4680	10'	5.86
24-5335	25'	13.49
24-5340	50'	19.49



Stellar Labs™

Audio Video Splitter Cable

Use to breakout the composite and stereo audio signals from the 4-pole 3.5mm A/V output on many popular portable devices, such as, portable DVD and MP3 video players. Great for finalizing the connection of your portable DVD player to the RCA composite video and stereo cables coming from your LCD TV and A/V receiver inputs. Length: 1½'.

Order #	MSRP	(1-9)	(10-up)
24-9760	\$12.95	\$6.25	\$4.31



Stellar Labs™

3.5mm 4-Pole AV Extension Cable

Extend an existing 4-pole 3.5mm A/V cable, or connect from a 3.5mm 4-pole adapter cable. Low-loss spiral-wrapped dual conductor provides excellent protection from EMI/RFI. Fully molded, gold plated connectors ensure superior strain relief and longevity.

dual conductor provides excellent protection from EMI/RFI. Fully molded, gold plated connectors ensure superior strain relief and longevity.

Order #	Length	MSRP	ONLY
24-10460	1½'	\$7.99	\$4.53
24-10461	3'	8.99	4.53
24-10462	6'	10.99	6.25
24-10463	12'	12.99	5.65
24-10464	25'	19.99	10.49
24-10465	50'	21.99	11.99
24-10466	75'	24.99	16.49
24-10467	100'	34.99	20.49



Stellar Labs™

Single Channel Audio Cables

Ideal for connecting your home theater receiver, satellite receiver, or any mono-audio single channel audio source to your subwoofer, or mono-audio installation. Dual conductor 90% spiral-wrapped cable. Bonded, tangle-free construction. Color-coded connectors. Single RCA male plug on both ends.

Order #	Length	MSRP	(1-9)	(10-up)
24-9500	1½'	\$7.95	\$3.73	\$2.50
24-9501	3'	8.95	4.23	2.98
24-9502	6'	11.95	6.15	4.29
24-9503	12'	14.95	7.16	5.00
24-9504	25'	28.95	16.49	11.56
24-9505	50'	44.95	22.99	15.47
24-9506	75'	56.95	28.99	20.05
24-9507	100'	72.95	37.49	26.07



Stellar Labs™

Premium Single Channel RCA Audio Cables

Designed for subwoofer and mono-audio applications. Features: Twisted pair, oxygen free copper construction. Gold plated, split-lock, audio RCA connectors. UL listed. 7.0mm outer diameter. Dual EMI/RFI shielding. Thick polyethylene dielectric. Limited life-time warranty.

Order #	Length	MSRP	(1-10)	(11-50)	(51-up)
24-8961	3'	\$17.95	\$7.06	\$5.85	\$5.66
24-8962	6'	19.95	8.07	7.43	7.20
24-8964	12'	25.95	10.49	8.50	8.24
24-8965	25'	23.95	12.49	10.66	10.31
24-8966	50'	36.95	22.49	19.22	18.60
24-8967	75'	44.95	30.49	25.63	24.83
24-8968	100'	62.95	36.49	32.07	31.05



Stellar Labs™

Premium Stereo Audio Cables

Provides excellent signal integrity and balanced audio integrity. Features: Twisted pair, oxygen free coaxial copper construction. Tangle free bonded wires. Gold plated, split-lock, stereo audio RCA connectors. UL listed cables. 7.0mm outer diameter. Dual EMI/RFI shielding. Thick polyethylene dielectric. Limited lifetime warranty.

Order #	Length	MSRP	(1-10)	(11-50)	(51-up)
24-8941	3'	\$54.95	\$18.49	\$14.90	\$13.35
24-8942	6'	88.95	25.49	19.53	17.47
24-8943	9'	99.95	27.49	21.39	19.12
24-8944	12'	99.95	30.49	24.17	21.59
24-8945	25'	119.00	38.49	28.81	25.71
24-8947	75'	179.00	32.49	-	-

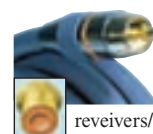

Stellar Labs™

Premium Digital Audio Cables

Ideal for DVD players, satellite receivers/TiVo®, Dolby Digital Surround Sound components, and high performance DTS. Features: UL listed. 7.0mm out diameter. Dual EMI/RFI shielding technology. Thick polyethylene dielectric to significantly reduce attenuation, and improve impedance. Limited lifetime warranty.

Order #	Length	MSRP	(1-2)	(3-9)	(10-up)
24-8970	1.5'	\$15.95	\$10.49	\$8.37	\$7.94
24-8971	3'	17.95	11.49	8.28	7.79
24-8972	6'	19.95	12.49	7.97	7.53
24-8973	9'	19.95	14.49	11.53	10.94
24-8974	12'	23.95	16.49	13.65	12.93
24-8975	25'	23.95	25.49	21.39	20.39

Audio Patch Cables

Banana Speaker Cables

Speaker cables for use when connecting home theater equipment with banana type connectors for speaker terminals.

Available in 16 and 18AWG with gold plated banana connectors. Sold one cable per package.



Order #	Length	ONLY
18 Gauge		
24-2600	6'	\$5.14
24-2605	10'	6.25
24-2610	25'	9.79
16 Gauge		
24-2625	6'	7.46
24-2630	10'	9.08
24-2635	25'	9.69
24-2640	50'	17.49



Audio "Y" Splitting Cables

Bonded, tangle-free construction.

Connect a single audio source to two devices, or split a mono audio signal for connection to a stereo input.



Order #	Length	MSRP	ONLY
Male plug to dual female jacks			
24-9470	1½'	\$8.99	\$4.84
24-9471	3'	8.99	5.04
24-9472	6'	10.95	5.85
24-9474	25'	18.95	11.49
Female jack to dual male plugs			
24-9480	1½'	8.99	4.84
24-9481	3'	9.99	5.54
24-9482	6'	10.95	5.85

WIRE & CABLE



Section
10



SLV Series Stereo Audio Cables

•Bonded, tangle-free construction •Dual conductor 90% spiral-wrapped cable •Color-coded connectors •Dual RCA male plugs to dual RCA plugs



Order #	Length	MSRP	ONLY
24-9510	1½'	\$9.99	\$4.94
24-9511	3'	12.95	6.05
24-9512	6'	13.95	8.07
24-9513	12'	18.95	9.08
24-9514	25'	21.95	12.49
24-9515	50'	39.95	20.49
24-9516	75'	49.95	24.49
24-9517	100'	74.95	33.49
24-9518	150'	96.95	46.49

Toslink Audio Cables

Digital Signal Convertors

Converts digital optical toslink cables to coaxial (RF) and vice versa. These adaptors are perfect for situations when your equipment does not have the input or output you would prefer. Power: 6VDC 250mA, adapter sold separately (#24-4451)



Order #	Input	Output	(ea.)	(2-4)
24-4440	Coaxial	Toslink	\$24.49	\$22.52
24-4445	Toslink	Coaxial	24.49	22.52
24-4451	Adapter		5.75	-

MCM Glass Digital Optical Cables

For the true audio purist nothing but high purity glass optical cables will do. These glass optical cables offer optimal frequency response and broader bandwidth through the use of high purity glass fiber cores and sophisticated mirror polishing techniques. The superior performance of these interconnects deliver audiophile quality sound in high-end home music systems.



Order #	Length	(ea.)	(2-4)	(5-up)
24-6485	1 meter	\$27.99	\$26.41	\$25.02
24-6490	2 meter	37.49	34.98	31.89

MCM Spring-Loaded Toslink Cables

Spring-loaded plugs correct for tolerance errors in optical cable jacks and result in a more accurate signal transfer.



Order #	Description	(ea.)	(2-4)	(5-up)
24-6415	1 meter	\$9.08	\$8.33	\$7.82
24-4405	2 meter	11.49	9.88	8.33
24-6420	3 meter	14.49	12.87	11.22
24-4410	5 meter	17.99	17.46	14.73

MCM Neon Spring-Loaded Toslink Cables

Add distinction to the digital audio system with neon cables. Spring-loaded plugs correct for tolerance errors in optical cable jacks and result in a more accurate signal transfer.



Order #	Length	(ea.)	(2-4)	(5-up)
Red				
24-6425	1 meter	\$9.28	\$7.87	\$7.16
24-6430	3 meter	13.49	11.45	10.02
24-4365	5 meter	16.99	15.03	13.48
Blue				
24-6445	1 meter	9.28	7.87	7.16
24-4390	2 meter	4.64	4.11	3.80
Green				
24-4375	2 meter	11.49	9.06	8.23
24-4380	5 meter	16.99	14.51	13.18



Toslink Optical Digital Audio Cables

Bonded, tangle-free construction. Superior sound quality and accurate transfer of digital audio source signals from DVD, surround sound receivers, digital cable boxes, and advanced gaming systems. High-quality precision-polished fiber optic connectors optimize signal transfer, while the PVC jacket adds flexibility and durability for years of listening enjoyment.



Order #	Length	MSRP	ONLY
24-9560	1½'	\$11.95	\$7.06
24-9561	3'	15.95	9.08
24-9562	6'	18.95	11.49
24-9563	9'	22.95	15.49
24-9564	12'	29.95	17.49

MCM Toslink Couplers

Toslink couplers to extend the length of digital optical cables.



Order #	Description	(ea.)	(2-4)	(5-up)
24-4320	Black	\$2.92	\$2.67	\$2.53
24-4325	Gold	2.92	2.59	2.45

Toslink Signal Splitters

These digital optical splitters allow the use of one digital audio device for two inputs. Connect a minidisc player or MP3 player to your computer and stereo receiver simultaneously.



Order #	(ea.)	(2-4)
24-4455	\$12.99	\$10.39

MCM Toslink to 3.5mm Adapter

Convert between Toslink and 3.5mm mini optical plugs, simply snap on the adapter that will mate with your audio device.



Order #	(ea.)	(2-4)	(5-up)
24-6570	\$4.23	\$4.03	\$3.90

Stellar Labs™ Premium Toslink Optical Digital Audio Cables

Optical fiber cables provide the ideal media for transporting audio data with no degradation to digital audio signal quality. •Spring-loaded metal connectors •Immune from EMI/RFI interference •6.00mm outer diameter



Order #	Length	MSRP	ONLY
24-8951	3'	\$29.95	\$25.49
24-8952	6'	39.95	35.49
24-8953	9'	42.95	44.49
24-8954	12'	49.95	50.49
24-8955	25'	69.95	66.99

Fiber-Optic Audio Cable

Popular replacement audio cable assembly for many different brands. Optical connector on both ends. 3" length.



Order #	Length	(ea.)	(2-4)	(5-up)
24-1451	3'	\$5.86	\$5.24	\$4.52
24-2585	6'	7.26	6.69	6.37
24-2590	9'	8.78	8.23	7.51

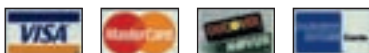



Section 10

WIRE & CABLE

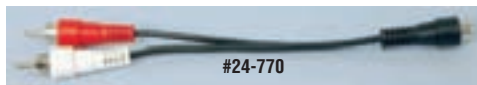

#24-770



#24-650

RCA "Y" Adapter Cables

•Divides a RCA input into two outputs

Order #	Description	ONLY
24-770	RCA jack to two RCA plugs	\$1.81
24-650	RCA plug to two RCA jacks	1.81



Bulk Stereo Patch Cables

Save money by purchasing your audio cables in bulk. These cables are available 20 per

package for home and automotive audio installation or use to give away when doing service calls. Two conductors, color coded for quick identification.

Order #	Length	Price per Cable	ONLY
24-2500	3'	\$1.92	\$38.49
24-2505	6'	2.37	47.49
24-2510	10'	3.40	67.99



RCA Piggyback Patch Cables

•RCA patch cable with two RCA plugs on one end and combination RCA plug/jack on other

end •Allows connection of two audio/video components to one input

Order #	Length	ONLY
24-640	3'	\$5.34
24-645	6'	5.34



RCA to RCA "Y" Cable

Order #	Length	(1-9)	(10-up)
AV00251	1.2m	\$1.81	\$1.57

Audio Patch Cables



RCA to RCA Stereo Cables

•High-quality molded construction •Dual RCA plugs •Color coded red and gray

Order #	Length	(ea.)	(2-4)	(5-up)
Gold Plated				
24-4620	1'	\$6.05	\$4.88	\$3.19
24-4625	2'	6.86	5.49	5.14
24-760	3'	7.06	5.04	4.52
24-765	6'	7.97	6.07	5.24
24-768	12'	10.49	8.13	7.00
24-769	20'	11.49	7.30	7.00
Nickel Plated				
24-4600	1'	3.93	2.98	2.88
24-4605	2'	3.42	2.77	2.68
24-090	3'	6.45	5.24	3.28
24-100	6'	4.94	3.75	3.39
24-103	10'	7.26	5.66	5.24
24-5345	15'	8.47	6.98	6.45
24-104	20'	10.49	8.03	7.51
24-1470	25'	11.49	9.16	8.81
24-1475	50'	16.49	14.10	13.72

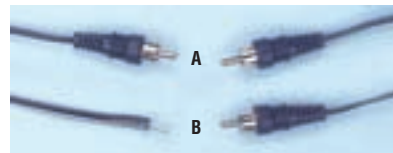

A. 10' RCA to RCA Plug

•24 gauge, stranded wire •Molded plugs

Order #	(ea.)	(2-4)	(5-up)
24-300	\$4.43	\$3.91	\$3.05

B. 8' RCA to Tinned Wire

•24 gauge, stranded wire •RCA plug one end, stripped and tinned on the other end

Order #	ONLY
28-580	\$1.50

3.5mm Audio Cables



Stellar Labs™ 3.5mm to Dual RCA Stereo Cables

Bonded, tangle-free construction. Perfect for connecting audio sources (iPod®, MP3, DVD, PC, and XM™ or Sirius™ satellite radio players) to an amplifier or home theater system. Features bonded wires and tangle-free construction to help facilitate flexibility and compatibility among audio interconnects while reducing cable clutter.

Order #	Length	MSRP	ONLY
24-9490	1½'	\$6.99	\$4.64
24-9491	3'	9.99	5.44
24-9492	6'	9.99	6.66
24-9493	12'	11.95	9.08
24-9494	25'	16.95	11.49

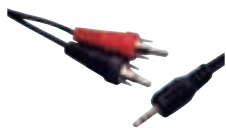

MCM 3.5mm Stereo to Two RCA

3.5mm male to two RCA

type male connectors for use with personal audio equipment and PC speakers.

Order #	Length	(ea.)	(2-4)
24-655	3'	\$6.25	\$5.14
24-6270	6'	7.26	5.97
24-6275	10'	10.99	9.06
24-6280	15'	14.49	11.74



MCM 3.5mm Extension Cables

3.5mm audio extension cables for use with personal audio equipment. Molded strain reliefs. Nickel plated plugs. Available stereo or mono.

Order #	Length	(ea.)	(2-4)	(5-up)
24-6230	3'	\$2.35	-	-
24-6235	6'	3.31	-	-
24-1050	12'	4.28	-	-
24-6240	20'	5.46	-	-
24-6245	25'	7.50	-	-
Monaural				
24-6250	3'	3.54	\$2.62	\$2.28
24-6255	6'	5.79	4.26	3.82
24-1045	12'	6.42	4.81	4.47
24-6260	20'	8.57	7.32	7.00
24-6265	25'	12.99	10.83	10.49



3.5mm to RCA Female

Use for connecting a 3.5mm line output to an amplifier or other RCA type line input. 12" in length.

Order #	Description	ONLY
24-4590	Stereo	\$4.53
24-4595	Mono	4.53

Pro Audio Patch Cables



Coiled Microphone Cord

Heavy-duty cord is ideal for many applications including PA and two-way radio. Tough outer jacket is ¼" diameter with ⅜" outside diameter coil. Contains five 24 gauge conductors plus bare shield around one. Cotton filament reinforced. Black.

Contains five 24 gauge conductors plus bare shield around one. Cotton filament reinforced. Black.

Order #	Length	(1-4)	(5-9)	(10-up)
111-1046	10'	\$5.14	\$4.83	\$4.52
111-1047	4'	3.12	2.88	2.67



Headphone Extension/Adapter Cable

•¼" stereo plug to 3.5mm stereo jack •3' coiled length; 20' extended length.

Order #	(ea.)	(2-4)	(5-up)
24-695	\$12.99	\$9.46	\$9.30



Stereo Headphone Extension Cable

•Quality construction with stress relief •3' coiled length; 25' extended length •¼" jack to ¼" plug

Order #	(ea.)	(2-4)	(5-up)
24-080	\$10.99	\$9.65	\$8.77

3.5mm Audio Cables



Premium 3.5mm to RCA Stereo Audio Cables

Features a tangle-free bonded wire construction that easily facilitates converting from 3.5mm stereo audio components to RCA stereo audio receivers, or speakers. Limited life-time warranty.



Order #	Length	MSRP	ONLY
24-8990	1½'	\$19.95	\$8.69
24-8991	3'	21.95	10.99
24-8992	6'	24.95	12.49
24-8994	12'	29.95	13.99
24-8995	25'	42.95	23.49
24-8996	50'	46.95	24.49
24-8997	75'	49.95	30.49
24-8998	100'	64.95	36.99



Premium 3.5mm Stereo Audio Cables

Carry both left and right audio channels over a single cable. Features: •Gold plated, corrosion free 3.5mm connectors •UL listed cable •7.0mm outer diameter, twisted-pair OFC construction •Dual EMI/RFI wire shielding •Thick polyethylene dielectric •Limited lifetime warranty



Order #	Length	MSRP	(1-10)	(11-50)	(51-up)
24-8985	25'	\$24.95	\$14.49	\$11.03	\$10.32
24-8986	50'	39.95	17.99	-	-
24-8987	75'	49.95	18.99	-	-

3.5mm Plug to 6.3mm Stereo Jack

•Stereo extension cable allows junction between 3.5mm plug and 6.3mm jack •Allows home stereo headphone to be used with walkman type portables or as an extension cable •6' length

Order #	(ea.)	(2-4)	(5-up)
24-1460	\$6.86	\$6.06	\$5.56

MCM

3.5mm Patch Cables

3.5mm audio patch cables for use with personal audio equipment. Molded strain reliefs. Nickel plated plugs. Available stereo or monoaural.

Order #	Length	(ea.)	(2-4)	(5-up)
Stereo				
24-6170	1'	\$4.64	\$3.00	\$2.59
24-6175	3'	6.66	4.83	4.16
24-815	6'	8.37	5.24	4.52
24-6180	10'	11.99	7.49	6.46
24-6185	15'	13.99	8.83	7.62
24-6190	20'	16.99	10.73	9.25
24-6195	25'	20.49	15.83	13.66
Monoaural				
24-6200	1'	4.13	3.00	2.59
24-6205	3'	6.66	4.83	4.16
24-810	6'	9.08	6.21	5.20
24-6210	10'	11.99	7.49	6.46
24-6215	15'	13.99	8.83	7.62
24-6220	20'	16.49	11.52	9.71
24-6225	25'	23.49	14.16	12.22

3.5mm "Y" Cable

3.5mm male plug to two 3.5mm female jacks.

Order #	Description	ONLY
24-2595	Mono	\$4.53
24-2596	Stereo	4.53

WIRE & CABLE



Section 10



3.5mm Stereo Audio Cables

Adapt from one connection to another, or extend an existing cable connection. •Bonded, tangle-free construction •Low-loss, spiral wrapped dual conductor provides excellent protection against EMI/RFI •Fully molded connectors provide excellent strain relief

Order #	Length	MSRP	ONLY
3.5mm male to male			
24-9520	1½'	\$5.99	\$2.92
24-9521	3'	8.99	5.04
24-9522	6'	9.99	4.53
24-9523	12'	10.95	5.65
24-9524	25'	15.95	7.06
24-9525	50'	24.95	10.49
24-9526	75'	29.95	13.99
24-9527	100'	39.95	17.49
3.5mm male to female			
24-9530	1½'	6.99	2.92
24-9531	3'	8.99	5.04
24-9532	6'	9.99	4.53
24-9533	12'	10.95	5.65
24-9534	25'	13.95	7.36
24-9535	50'	24.95	10.49
24-9536	75'	34.95	13.99
24-9537	100'	44.95	19.49

3.5mm to RCA Plug Cables

•3.5mm mono plug to RCA plug

Order #	Length	(ea.)	(2-4)	(5-up)
24-665	3'	\$3.02	\$1.99	\$1.74
24-670	6'	5.54	4.31	3.49

Pro Audio Patch Cables



Zip Speaker Cable

Horizon's most economical speaker cable using two parallel conductors, one silver, the other copper for ease of identification. Using rugged PVC jacketed material and standard nickel plated ¼" connectors.

Order #	Length	AWG	(1-3)	(4-up)
555-1765	50'	18	\$19.49	\$16.06
555-1770	100'	18	28.99	24.79
555-1773	50'	16	30.99	27.30



Commercial Speaker Cable

This is Horizon's most popular speaker cable. Using bare copper stranded, twisted pair conductors each individually jacketed with an overall jacket added for durability. Commercial grade speaker cable is flexible and will stand the test of time. Standard with ¼" connectors.

Order #	Length	AWG	(1-3)	(4-up)
555-1780	10'	16	\$12.99	\$10.83
555-1790	25'	16	18.99	17.56
555-1795	50'	16	21.49	19.04
555-1810	50'	14	27.49	24.81
555-1820	25'	12	29.49	25.23



Premium Series Guitar Cables

The ultimate guitar cable for the touring professionals. This premium cable uses a 95% braided shield which will allow only the most pure transfer of signal and noise free operation, combined with an 18 gauge center conductor which enhances the frequency response of your equipment. Using an ultra flexible jacketing material keeps the cable flat on stage. These are a must for the players serious about sound! Specifications: •Conductors: (1) 18 gauge (High-Z) •Shield: 95% coverage pure copper •Jacket: Matte PVC •O.D.: 0.226" •Capacitance: 45pf./ft. @ 1KHz •Resistance: 5.6ohm @ 20°C/1000' •Limited lifetime manufacturers warranty.

Order #	Length	(1-3)	(4-up)
555-1640	20'	\$28.49	\$26.06



Premium Quality Microphone Cables

Constructed with two conductor, shielded, vinyl jacketed, broadcast type cable, with hand soldered connectors.

Order #	Length	(1-3)	(4-up)
XLR Male to Female Cable			
35-1340	10'	\$21.99	\$20.19
35-1341	20'	24.49	22.84
35-1342	25'	25.49	23.45
35-1343	30'	26.59	24.47
35-1344	50'	30.59	28.14
35-1345	100'	42.89	39.77
XLR Female to ¼" Cable			
35-1346	10'	10.70	9.66



Stereo Patch Cable

High-quality, highly flexible cable provides L/R unbalanced audio channels, terminated with male RCA phono connectors on one end, and male ¼" connectors at the other. 5' length.

Order #	(1-3)	(4-up)
555-8640	\$9.69	\$8.60



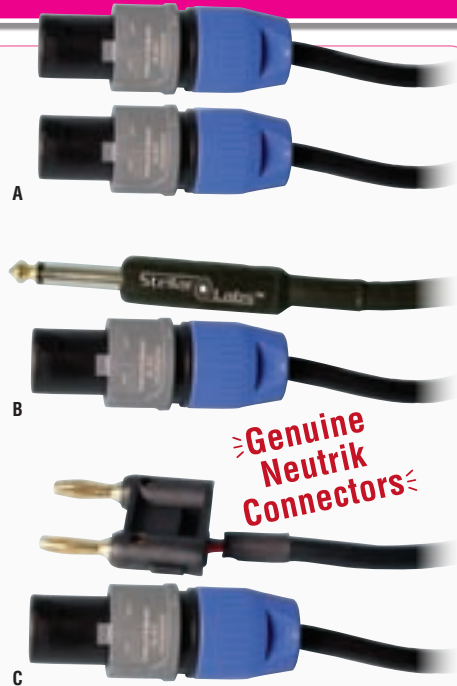

Professional Speakon® Speaker Cables

Designed for rugged pro sound and stage use, these heavy-duty cables feature original Neutrik Speakon® connectors and are available in 12 and 16 gauge configurations. Various connector configurations allow compatibility with most amplifiers and speakers in use today.

Connectors	Fig.	Order #	Length	MSRP	(1-3)	(4-up)
12 Gauge						
Speakon® to Speakon®	A	24-10475	25'	\$59.95	\$45.49	\$37.05
Speakon® to Speakon®	A	24-10476	50'	79.95	68.99	55.59
Speakon® to Speakon®	A	24-10477	100'	129.95	114.00	93.00
Speakon® to 1/4" male	B	24-10478	25'	59.95	45.49	37.05
Speakon® to 1/4" male	B	24-10479	50'	79.95	67.99	55.59
Speakon® to 1/4" male	B	24-10480	100'	129.95	114.00	93.00
Speakon® to banana	C	24-10481	25'	59.95	45.49	37.05
Speakon® to banana	C	24-10482	50'	79.95	67.99	55.59
Speakon® to banana	C	24-10483	100'	129.95	114.00	93.00
16 Gauge						
Speakon® to Speakon®	A	24-10485	25'	49.95	34.49	27.78
Speakon® to Speakon®	A	24-10486	50'	59.95	45.49	37.05
Speakon® to Speakon®	A	24-10487	100'	89.95	68.99	55.59
Speakon® to 1/4" male	B	24-10488	25'	49.95	34.49	27.78
Speakon® to 1/4" male	B	24-10489	50'	59.95	45.49	37.05
Speakon® to 1/4" male	B	24-10490	100'	89.95	68.99	55.59
Speakon® to banana	C	24-10491	25'	49.95	34.49	27.78
Speakon® to banana	C	24-10492	50'	59.95	45.49	37.05
Speakon® to banana	C	24-10493	100'	89.95	68.99	55.59

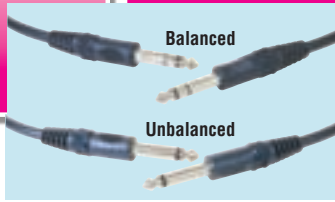

Professional 1/4" to 1/4" Patch Cables

Noise-free 1/4" male to male cables are ideal for interconnection between amplifiers and mixers, processors and source gear. They are also suitable for musical instrument use. Available in two conductor configuration, or three conductor TRS configuration for single channel balanced, or two channel unbalanced stereo use. Terminated with durable, fully molded 1/4" male plugs.

Order #	Length	MSRP	ONLY
Balanced			
24-9870	2'	\$6.99	\$4.43
24-9871	3'	7.99	5.04
24-9872	6'	9.99	5.65
24-9873	10'	13.95	8.07
24-9874	15'	13.95	8.27
24-9875	25'	13.95	11.49
Unbalanced			
24-9880	2'	6.99	4.33
24-9881	3'	7.99	4.53
24-9882	6'	9.99	5.14
24-9883	10'	13.95	7.46
24-9884	15'	13.95	7.87
24-9885	25'	19.95	10.49



Professional Balanced XLR Female to 1/4" Patch Cables

Balanced audio stage cables are ideal for professional sound and stage applications requiring balanced input to balanced source connections. High-quality, rugged and durable, these cables are constructed with noise-free, Lo-Z shielded wire, and terminated with reliable latch-lock, 3 pin XLR connectors, and fully molded 1/4" 3 conductor (TRS) male plugs.

Order #	Length	MSRP	(1-3)	(4-up)
24-9830	2'	\$10.95	\$5.54	\$4.53
24-9831	3'	11.95	6.76	5.64
24-9832	6'	13.95	7.26	5.84
24-9833	10'	16.95	9.79	8.30
24-9834	15'	16.95	9.89	8.23
24-9835	25'	12.95	12.99	10.19



Professional XLR Female to 1/4" Patch Cables

Ideal for professional sound and stage applications, these cables are used to connect balanced XLR sources to unbalanced inputs on mixers and amplifiers. High-quality, rugged and durable, these cables are constructed with noise-free, Lo-Z shielded wire, and terminated with reliable latch-lock, 3 pin XLR connectors, and fully molded 1/4" 2-conductor male plugs.

Order #	Length	MSRP	(1-3)	(4-up)
24-9840	2'	\$10.95	\$5.85	\$5.24
24-9841	3'	11.95	6.05	4.91
24-9842	6'	13.95	7.46	6.07
24-9843	10'	16.95	8.88	7.22
24-9844	15'	16.95	9.08	7.40
24-9845	25'	22.95	12.99	10.19



Professional Eight Channel XLR Snake Cable

Noise-free, studio quality, eight-channel balanced audio snake cables terminated with durable, metal, latch-lock, 3 pin XLR connectors on both ends (male-to-female). Balanced, Lo-Z shielded wire and reinforced strain relief for professional sound in demanding environments.

Order #	Length	MSRP	(1-3)	(4-up)
24-9800	6'	\$54.95	\$30.49	\$25.00
24-9801	15'	69.95	40.49	31.99
24-9802	20'	76.95	43.49	35.19



Professional Eight Channel XLR to Balanced TRS Snake Cable

Studio quality, noise-free, eight-channel balanced audio snake cable is terminated with durable, metal, latch-lock, 3 pin XLR connectors on one end (male or female), and fully molded, TRS 1/4" color-coded connectors on the other. Balanced, Lo-Z shielded wire and reinforced strain relief for professional sound in demanding stage environments.

Order #	Length	MSRP	(1-3)	(4-up)
Male XLR to TRS 1/4"				
24-9805	6'	\$39.95	\$33.49	\$18.50
24-9807	20'	65.95	40.49	30.55
Female XLR to TRS 1/4"				
24-9810	6'	39.95	25.49	18.50
24-9812	20'	65.95	40.49	30.55



Professional Eight Channel Balanced TRS Snake Cable

Studio quality, noise-free, eight-channel balanced audio snake cable is terminated with durable, fully molded, TRS 1/4" color-coded male plugs on both ends. Balanced, Lo-Z shielded wire and reinforced strain relief for professional sound.

Order #	Length	MSRP	(1-3)	(4-up)
24-9815	6'	\$25.95	\$22.99	\$20.22
24-9817	20'	39.95	38.49	30.79

Professional Audio Cables



Stellar Labs™ Professional

Balanced XLR Male to Female Patch Cables

High-quality, balanced audio stage cables are the ideal choice for professional sound applications including connections from balanced sources, like microphones, mixers and equalizers to balanced amplifier inputs. Rugged and durable, these cables are constructed with noise-free, shielded Lo-Z wire, and terminated with reliable latch-lock, 3 pin XLR connectors. **NEW!**

Order #	Length	MSRP	ONLY
24-9820	2'	\$11.95	\$7.46
24-9821	3'	12.95	8.78
24-9822	6'	14.95	9.99
24-9823	10'	17.95	11.49
24-9824	15'	18.95	11.99
24-9825	25'	29.95	14.99



Stellar Labs™ Professional XLR to RCA Patch Cables

Ideal for studio and stage production, these high-quality, noise-free, cables are used to connect balanced XLR sources to unbalanced inputs on mixers and amplifiers. They are constructed with Hi-Z shielded wire, terminated with rugged and durable latch-lock, 3 pin XLR connectors (male-to-female), and fully molded RCA plugs to provide L/R unbalanced audio channels. **NEW!**

Order #	Length	MSRP	ONLY
Male XLR to RCA			
24-9860	2'	\$10.95	\$5.04
24-9861	3'	11.95	5.04
24-9862	6'	13.95	5.66
24-9864	15'	16.95	9.08
Female XLR to RCA			
24-9850	2'	10.95	5.04
24-9851	3'	11.95	5.04
24-9852	6'	13.95	7.06
24-9854	15'	16.95	9.08



PYLE® Eight Channel RCA Phono Snake Cable

High-quality, highly flexible cable provides eight unbalanced audio channels, terminated with male RCA connectors at each end. Length listed below is overall, including break out. **NEW!**

Order #	Length	MSRP	(1-3)	(4-up)
555-8625	10'	\$25.95	\$22.99	\$20.34
555-8626	20'	39.95	35.99	31.67

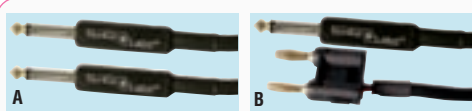

Stellar Labs™ Professional

Speaker Cables

✓ Available in 12AWG or 16AWG
 ✓ Commercial grade construction **NEW!**

Connectors Fig. Order #	Length	MSRP	ONLY
12 Gauge			
1/4" to 1/4"			
A 24-10575	25'	\$39.99	\$23.49
1/4" to 1/4"			
A 24-10576	50'	79.99	42.49
1/4" to 1/4"			
A 24-10577	100'	119.99	80.99
1/4" to banana plugs			
B 24-10578	25'	39.99	22.99
1/4" to banana plugs			
B 24-10579	50'	79.99	42.49
1/4" to banana plugs			
B 24-10580	100'	119.99	79.99
Banana plugs to banana plugs			
C 24-10581	25'	39.99	22.99
Banana plugs to banana plugs			
C 24-10582	50'	79.99	41.99
Banana plugs to banana plugs			
C 24-10583	100'	119.99	79.99
16 Gauge			
1/4" to 1/4"			
A 24-10585	25'	29.99	12.99
1/4" to 1/4"			
A 24-10586	50'	49.99	21.99
1/4" to 1/4"			
A 24-10587	100'	69.99	38.99
1/4" to banana plugs			
B 24-10588	25'	29.99	12.99
1/4" to banana plugs			
B 24-10589	50'	49.99	21.49
1/4" to banana plugs			
B 24-10590	100'	69.99	38.49
Banana plugs to banana plugs			
C 24-10591	25'	29.99	12.49
Banana plugs to banana plugs			
C 24-10592	50'	49.99	21.49
Banana plugs to banana plugs			
C 24-10593	100'	69.99	38.49

SONY Audio Plug Adapter

•Connects stereo mini plug into stereo phone plug •Used to connect headphones with stereo mini plug to headphone jack of stereo amplifier **NEW!**

Order #	(1-3)	(4-up)
PC-234S	\$4.43	\$3.11

Stellar Labs™ Professional

Three Pin DMX Cables

DMX cables utilize a twisted pair of 110ohm conductors, ensuring a much more reliable data transfer than standard XLR cables, and are specifically designed for any professional lighting control setup. **NEW!**

Order #	Length	MSRP	ONLY
555-11900	3'	\$12.99	\$4.23
555-11901	6'	15.99	5.04
555-11902	10'	18.99	5.65
555-11903	15'	21.99	6.86
555-11904	30'	29.99	9.69
555-11905	50'	39.99	13.99
555-11906	75'	59.99	18.99

WIRE & CABLE



Section 10

1/4" "Y"

Adapter Cable

•1/4" stereo plug to two 1/4" stereo jacks •Allows simultaneous use of two pairs of headphones from one jack **NEW!**

Order #	ONLY
24-690	\$7.06

1/4" Stereo Plug to RCA Plugs Cable

•1/4" stereo plug to two RCA plugs used with amplifiers and mixers •6' length **NEW!**

Order #	ONLY
24-1040	\$4.03

RCA Plug to 1/4" Mono Plug Cable

•Adapts 1/4" mono plug to a RCA plug •6' length **NEW!**

Order #	ONLY
24-675	\$3.93

Color Coded Patch Cables

A set of six color coded patch cables (yellow, red, green, blue, black and white) to make identification much easier. 1/4" monaural, right angled plugs on each end. Ideal for PA and music sound systems. **NEW!**

Order #	Length	ONLY
24-5395	1'	\$9.08
24-5400	6'	12.49

DC Power Extensions



DC Power Extension Cables

These female to male DC power cables offer an easy solution for extending the length of a DC power supply. Features: •High-quality plugs and jacks with strain reliefs •Available in either straight or right angle **NEW!**

Order #	Length	Size	ONLY
Straight Plug			
23-760	1.5m	2.1mm	\$3.32
23-761	3m	2.1mm	4.13
23-762	5m	2.1mm	6.76
23-763	10m	2.1mm	11.49
23-765	1.5m	2.5mm	3.12
23-766	3m	2.5mm	4.13
23-767	5m	2.5mm	6.66
23-768	10m	2.5mm	10.49
Right Angle Plug			
23-770	1m	2.1mm	3.12
23-771	2m	2.1mm	4.43
23-772	3m	2.1mm	5.14
23-773	5m	2.1mm	6.66
23-774	10m	2.1mm	10.49
23-775	1m	2.5mm	3.42
23-776	2m	2.5mm	4.13
23-777	3m	2.5mm	5.54
23-778	5m	2.5mm	6.25
23-779	10m	2.5mm	10.49

