

MGA-725M4

Low Noise Amplifier with Bypass Switch In Miniature Leadless Package



Data Sheet

Description

Avago Technologies's MGA-725M4 is an economical, easy-to-use GaAs MMIC Low Noise Amplifier (LNA), which is designed for an adaptive CDMA receiver LNA and adaptive CDMA transmit driver amplifier.

The MGA-725M4 features a typical noise figure of 1.4 dB and 14.4 dB associated gain from a single stage, feedback FET amplifier. The output is internally matched to 50Ω. The input is optimally internally matched for lowest noise figure into 50Ω. The input may be additionally externally matched for low VSWR through the addition of a single series inductor. When set into the bypass mode, both input and output are internally matched to 50Ω.

The MGA-725M4 offers an integrated solution of LNA with adjustable IIP3. The IIP3 can be fixed to a desired current level for the receiver's linearity requirements. The LNA has a bypass switch function, which sets the current to zero and provides low insertion loss. The bypass mode also boosts dynamic range when high level signal is being received.

For the CDMA driver amplifier applications, the MGA-725M4 provides suitable gain and linearity to meet the ACPR requirement when the handset transmits the highest power. When transmitting lower power, the MGA-725M4 can be bypassed, saving the drawing current.

The MGA-725M4 is a GaAs MMIC, processed on Avago's cost effective PHEMT (Pseudomorphic High Electron Mobility Transistor). It is housed in the MiniPak 1412 package. It is part of the Avago Technologies CDMA Advantage RF chipset.

Simplified Schematic

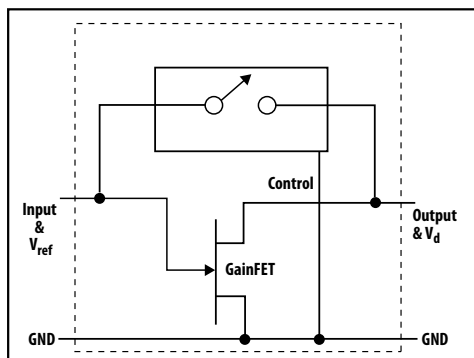

Features

- Operating frequency:
0.1 GHz ~ 6.0 GHz
- Noise figure:
1.2 dB at 800 MHz
1.4 dB at 1900 MHz
- Gain:
17.5 dB at 800 MHz
15.7 dB at 1900 MHz
- Bypass switch on chip
Loss = typ 1.6 dB ($I_d < 5 \mu A$)
IIP3 = +10 dBm
- Adjustable Input IP3:
+2 to +14.7 dBm
- Miniature package:
1.4 mm x 1.2 mm
2.7 V to 5.0 V operation

Applications

- CDMA (IS-95, J-STD-008) Receiver LNA
- Transmit Driver Amp
- TDMA (IS-136) handsets

MiniPak 1.4 mm x 1.2 mm Package

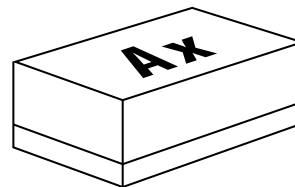

Pin Connections and Package Marking

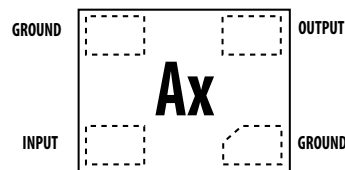

MGA-725M4 Absolute Maximum Ratings^[1]

Symbol	Parameter	Units	Absolute Maximum	Operation Maximum
V_d	Maximum Input to Output Voltage	V	5.5	4.2
V_{gs}	Maximum Input to Ground DC Voltage	V	+3 -5.5	+1 -4.2
I_d	Supply Current	mA	70	60
P_d	Power Dissipation ^[1,2]	mW	300	250
P_{in}	CW RF Input Power	dBm	+20	+13
T_j	Junction Temperature	°C	170	150
T_{STG}	Storage Temperature	°C	-65 to +150	-40 to +85

Thermal Resistance:^[2]

$$\theta_{jc} = 180^{\circ}\text{C/W}$$

Notes:

1. Operation of this device in excess of any of these limits may cause permanent damage.
2. $T_{case} = 25^{\circ}\text{C}$.

Electrical Specifications, $T_c = +25^{\circ}\text{C}$, $Z_0 = 50\Omega$, $I_d = 20\text{ mA}$, $V_d = 3\text{ V}$, unless noted.

Symbol	Parameter and Test Condition	Units	Min.	Typ.	Max.	σ	
$V_{gs\ test}^{[1]}$	$f = 2.0\text{ GHz}$ $V_d = 3.0\text{V}$ ($V_{ds} = 2.5\text{V}$)	$I_d = 20\text{ mA}$	V	-0.65	-0.51	-0.37	0.035
NF test ^[1]	$f = 2.0\text{ GHz}$ $V_d = 3.0\text{V}$ ($= V_{ds} - V_{gs}$)	$I_d = 20\text{ mA}$	dB	1.4	1.8	0.06	
Ga test ^[1]	$f = 2.0\text{ GHz}$ $V_d = 3.0\text{V}$ ($= V_{ds} - V_{gs}$)	$I_d = 20\text{ mA}$	dB	13.5	14.4	15.5	0.42
IIP3 test ^[1]	$f = 2.04\text{ GHz}$ $V_d = 3.0\text{V}$ ($= V_{ds} - V_{gs}$)	$I_d = 20\text{ mA}$	dBm	8.5	9.9		0.35
IL test ^[1,4]	$f = 2.0\text{ GHz}$ $V_d = 3.0\text{V}$ ($V_{ds} = 0\text{V}$, $V_{gs} = -3\text{V}$)	$I_d = 0.0\text{ mA}$	dB	1.6	3.5	0.07	
Ig test ^[1,4]	$f = 2.0\text{ GHz}$ $V_d = 3.0\text{V}$ ($V_{ds} = 0\text{V}$, $V_{gs} = -3\text{V}$)	$I_d = 0.0\text{ mA}$	μA	2.0		2.0	
Nfo ^[2]	Minimum Noise Figure As measured in Figure 2 Test Circuit (Computed from s-parameter and noise parameter performance as measured in a 50 Ω impedance fixture)	$f = 1.0\text{ GHz}$ $f = 1.5\text{ GHz}$ $f = 2.0\text{ GHz}$ $f = 2.5\text{ GHz}$ $f = 4.0\text{ GHz}$ $f = 6.0\text{ GHz}$	dB		1.2 1.2 1.3 1.3 1.4 1.6		
Gain ^[2]	Associated Gain at Nfo As measured in Figure 2 Test Circuit (Computed from s-parameter and noise parameter performance as measured in a 50 Ω impedance fixture)	$f = 1.0\text{ GHz}$ $f = 1.5\text{ GHz}$ $f = 2.0\text{ GHz}$ $f = 2.5\text{ GHz}$ $f = 4.0\text{ GHz}$ $f = 6.0\text{ GHz}$	dB		17.6 16.6 15.7 14.8 12.8 10.6		
P1dB ^[1]	Output Power at 1 dB Gain Compression As measured in Figure 1 Test Circuit Frequency = 2.04 GHz	$I_d = 0\text{ mA}$ $I_d = 5\text{ mA}$ $I_d = 10\text{ mA}$ $I_d = 20\text{ mA}$ $I_d = 40\text{ mA}$ $I_d = 60\text{ mA}$	dBm		15.2 3.4 9.14 13.13 15.25 16.16	0.53	
IIP3 ^[1]	Input Third Order Intercept Point As measured in Figure 1 Test Circuit Frequency = 2.04 GHz	$I_d = 0\text{ mA}$ $I_d = 5\text{ mA}$ $I_d = 10\text{ mA}$ $I_d = 20\text{ mA}$ $I_d = 40\text{ mA}$ $I_d = 60\text{ mA}$	dBm		35 3.1 6.6 9.9 13.0 14.7	0.35	
RLin ^[1]	Input Return Loss as measured in Fig. 1	$f = 2.0\text{ GHz}$	dB		-8.2	0.41	
RLout ^[1]	Output Return Loss as measured in Fig. 1	$f = 2.0\text{ GHz}$	dB		-15	1.3	
ISOL ^[1]	Isolation $ S_{12} ^2$ As measured in Fig. 2	$f = 2.0\text{ GHz}$	dB		-23.4	0.4	

Notes:

1. Standard deviation and typical data as measured in the test circuit of Figure 1. Data based on 500 part sample size from 3 wafer lots.
2. Typical data computed from S-parameter and noise parameter data measured in a 50 Ω system.
3. $V_d =$ total device voltage $= V_{dg}$
4. Bypass mode voltages shown are used in production test. For source resistor biasing, Bypass mode is set by opening the source resistor.

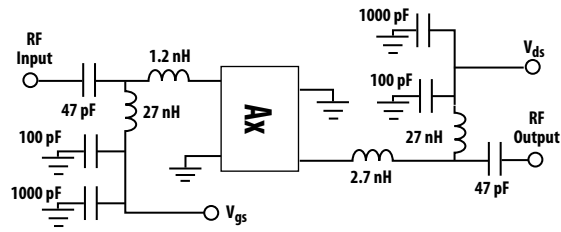

Figure 1. MGA-725M4 Production Test Circuit.

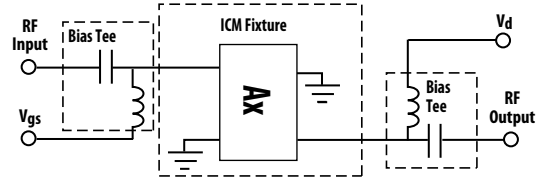

Figure 2. MGA-725M4 50Ω Test Circuit for S, Noise, and Power Parameters.

MGA-725M4 Typical Performance

Frequency = 2.0 GHz, $T_c = 25^\circ\text{C}$, $Z_o = 50\Omega$, $V_d = 3\text{V}$, $I_d = 20\text{ mA}$ unless stated otherwise. All data as measured in Figure 2 test system (input and output presented to 50Ω).

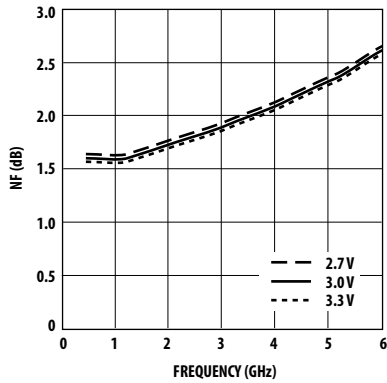

Figure 3. Noise Figure vs. Frequency and Voltage.

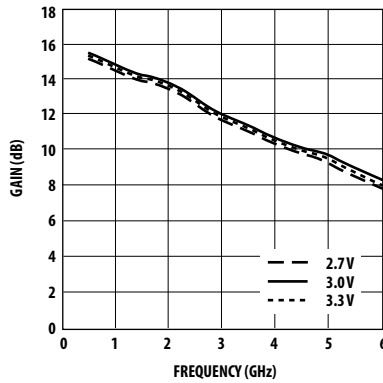

Figure 4. Gain vs. Frequency and Voltage.

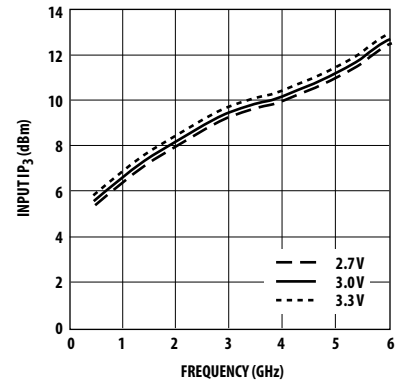

Figure 5. Input Third Order Intercept Point vs. Frequency and Voltage.

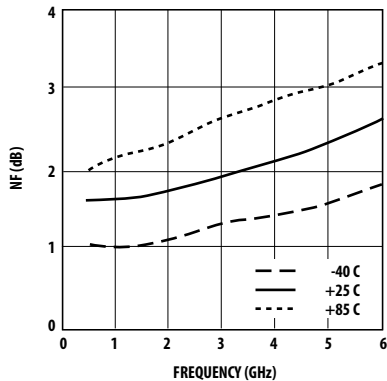

Figure 6. Noise Figure vs. Frequency and Temperature.

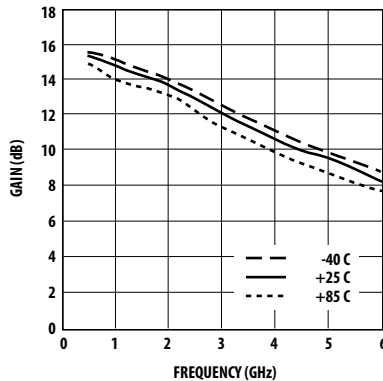

Figure 7. Gain vs. Frequency and Temperature.

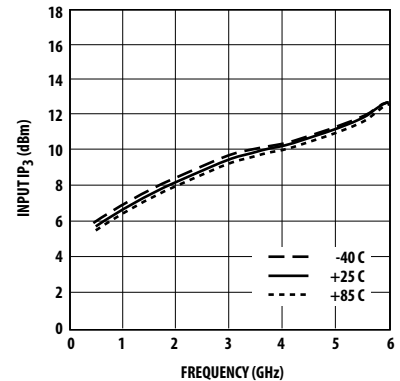

Figure 8. Input Third Order Intercept Point vs. Frequency and Temperature.

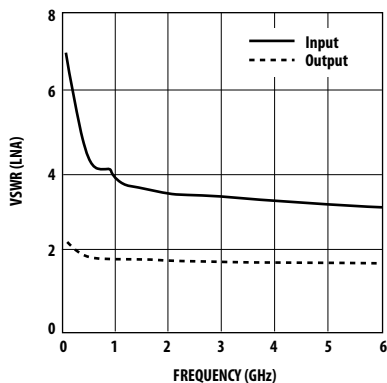

Figure 9. LNA on (Switch off) VSWR vs. Frequency.

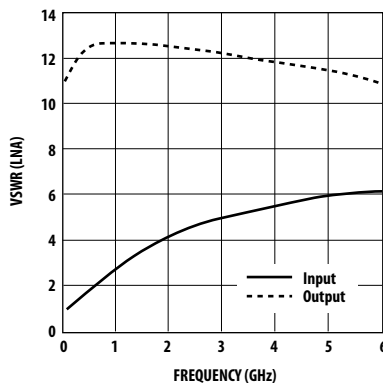

Figure 10. LNA off (Switch on) VSWR vs. Frequency.

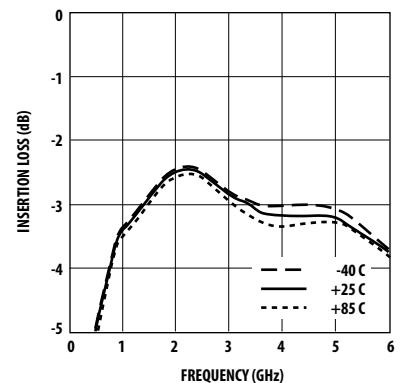

Figure 11. Insertion Loss (Switch on) vs. Frequency and Temperature.

MGA-725M4 Typical Performance, continued

Frequency = 2.0 GHz, $T_c = 25^\circ\text{C}$, $Z_o = 50\Omega$, $V_d = 3\text{V}$, $I_d = 20\text{ mA}$ unless stated otherwise. All data as measured in Figure 2 test system (input and output presented to 50Ω).

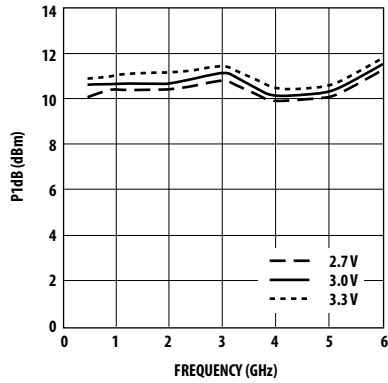

Figure 12. Output Power at 1 dB Compression vs. Frequency and Voltage.

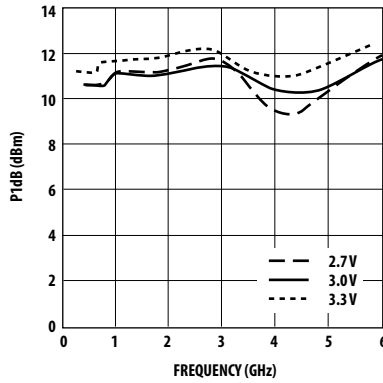

Figure 13. Output Power at 1 dB Compression vs. Frequency and Temperature.

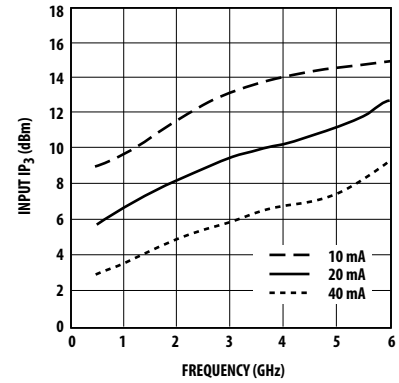

Figure 14. Input Third Order Intercept Point vs. Frequency and Current.

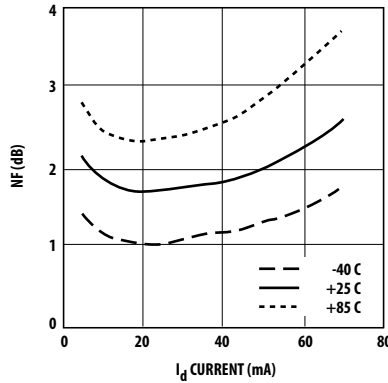

Figure 15. Noise Figure vs. Current and Temperature.

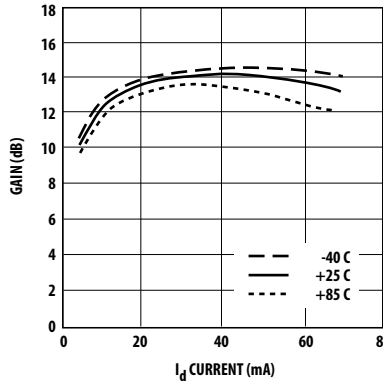

Figure 16. Associated Gain vs. Current and Temperature.

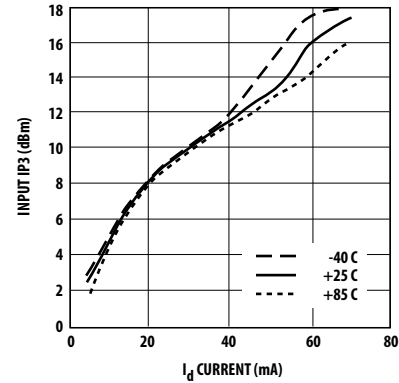

Figure 17. Input Third Intercept Point vs. Current and Temperature.

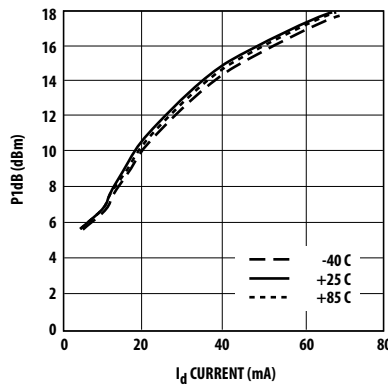

Figure 18. Output Power at 1 dB Compression vs. Current and Temperature.

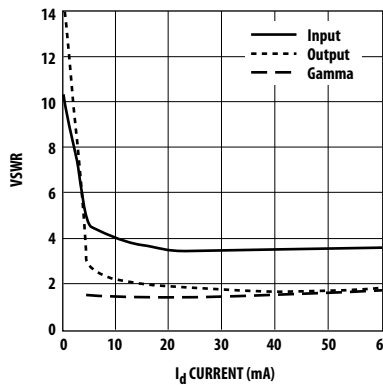

Figure 19. LNA on VSWR and Gamma Opt vs. Current.

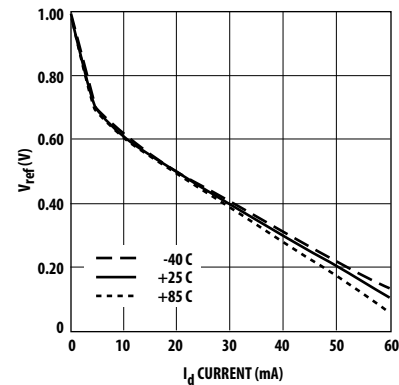

Figure 20. Control Voltage vs. Current and Temperature.

MGA-725M4 Typical Scattering Parameters: Bypass Mode

$T_c = 25^\circ\text{C}$, $V_d = 3.0\text{ V}$, $I_d = 0\text{ mA}$, $Z_o = 50\Omega$ (test circuit of Figure 2)

Freq (GHz)	S_{11} Mag.	S_{11} Ang.	S_{21} Mag.	S_{21} Ang.	S_{12} Mag.	S_{12} Ang.	S_{22} Mag.	S_{22} Ang.	S_{11} (dB)	S_{21} (dB)	S_{12} (dB)	S_{22} (dB)
0.1	0.991	-11.1	0.175	74.9	0.175	75.5	0.943	-15.1	-0.08	-15.12	-15.16	-0.51
0.5	0.741	-44.1	0.592	37.9	0.593	38.1	0.624	-51.1	-2.61	-4.55	-4.54	-4.09
0.8	0.580	-5.8	0.710	22.8	0.709	22.9	0.470	-64.1	-4.74	-2.97	-2.99	-6.57
0.9	0.536	-61.8	0.733	18.9	0.732	19.0	0.429	-67.3	-5.41	-2.70	-2.71	-7.34
1.0	0.498	-64.6	0.751	15.4	0.750	15.6	0.400	-69.6	-6.05	-2.49	-2.50	-7.95
1.1	0.468	-66.8	0.764	12.5	0.763	12.4	0.371	-72.3	-6.60	-2.34	-2.35	-8.61
1.2	0.442	-69.2	0.775	9.7	0.774	9.8	0.346	-74.0	-7.09	-2.22	-2.22	-9.21
1.3	0.418	-70.9	0.783	7.1	0.783	7.3	0.328	-75.8	-7.58	-2.12	-2.13	-9.68
1.4	0.395	-72.6	0.793	4.7	0.791	5.0	0.309	-77.2	-8.06	-2.02	-2.04	-10.19
1.5	0.378	-74.7	0.797	2.7	0.796	2.7	0.293	-78.2	-8.45	-1.98	-1.98	-10.65
1.6	0.362	-76.0	0.799	0.5	0.800	0.7	0.281	-79.5	-8.84	-1.94	-1.94	-11.03
1.7	0.349	-77.6	0.805	-1.5	0.805	-1.3	0.267	-80.4	-9.14	-1.88	-1.89	-11.46
1.8	0.334	-78.9	0.809	-3.3	0.809	-3.1	0.258	-80.9	-9.53	-1.84	-1.84	-11.75
1.9	0.326	-79.9	0.811	-5.1	0.811	-5.1	0.247	-81.8	-9.74	-1.82	-1.82	-12.13
2.0	0.357	-85.4	0.826	-8.5	0.827	-8.3	0.243	-86.5	-8.96	-1.66	-1.65	-12.29
2.1	0.345	-86.0	0.826	-10.2	0.827	-10.0	0.238	-87.8	-9.25	-1.66	-1.65	-12.47
2.2	0.338	-86.6	0.825	-11.5	0.825	-11.5	0.230	-88.5	-9.43	-1.67	-1.67	-12.77
2.3	0.326	-87.7	0.826	-13.2	0.825	-12.9	0.228	-89.3	-9.73	-1.66	-1.67	-12.86
2.4	0.321	-87.9	0.825	-14.7	0.824	-14.4	0.222	-90.6	-9.87	-1.67	-1.69	-13.06
2.5	0.319	-88.9	0.825	-14.6	0.824	-14.6	0.218	-90.1	-9.92	-1.67	-1.68	-13.24
3.0	0.288	-93.8	0.820	-21.2	0.820	-21.4	0.206	-94.6	-10.81	-1.72	-1.72	-13.74
3.5	0.272	-97.0	0.816	-27.4	0.815	-27.4	0.198	-98.8	-11.31	-1.76	-1.77	-14.06
4.0	0.263	-101.4	0.810	-33.5	0.811	-33.6	0.195	-103.8	-11.59	-1.83	-1.82	-14.18
4.5	0.256	-106.1	0.807	-39.3	0.806	-39.2	0.192	-108.9	-11.84	-1.86	-1.88	-14.33
5.0	0.249	-110.9	0.800	-45.2	0.800	-45.2	0.190	-114.5	-12.07	-1.94	-1.93	-14.41
5.5	0.243	-114.8	0.793	-50.7	0.795	-50.7	0.191	-119.7	-12.30	-2.01	-2.00	-14.39
6.0	0.229	-117.1	0.781	-57.0	0.783	-57.0	0.260	-138.9	-12.81	-2.14	-2.13	-11.69
6.5	0.227	-125.3	0.774	-62.6	0.773	-62.6	0.256	-146.5	-12.88	-2.23	-2.23	-11.83
7.0	0.218	-130.1	0.764	-68.1	0.768	-67.9	0.252	-153.6	-13.25	-2.34	-2.30	-11.99
7.5	0.221	-137.5	0.758	-73.5	0.760	-73.2	0.243	-159.8	-13.11	-2.40	-2.39	-12.28
8.0	0.224	-144.2	0.749	-79.1	0.753	-78.9	0.230	-166.5	-12.98	-2.51	-2.46	-12.75

MGA-725M4 Typical Scattering Parameters and Noise Parameters

$T_c = 25^\circ\text{C}$, $V_d = 3.0\text{V}$, $I_d = 5\text{mA}$, $Z_0 = 50\Omega$ (test circuit of Figure 2)

Freq (GHz)	S_{11} Mag.	S_{11} Ang.	S_{21} Mag.	S_{21} Ang.	S_{12} Mag.	S_{12} Ang.	S_{22} Mag.	S_{22} Ang.	S_{21} (dB)	RL_{in} (dB)	RL_{out} (dB)	G_{max} (dB)	Isolation (dB)
0.10	0.83	-8	4.17	175	0.05	20	0.58	-7	12.4	-1.6	-4.7	18.7	-25.8
0.50	0.73	-24	4.32	164	0.06	13	0.51	-13	12.7	-2.7	-5.8	16.6	-24.4
0.80	0.71	-35	4.19	156	0.06	18	0.51	-19	12.4	-3.0	-5.9	16.5	-24.0
0.90	0.71	-39	4.14	153	0.06	19	0.50	-21	12.3	-3.0	-6.0	16.6	-23.9
1.00	0.69	-42	4.09	151	0.07	20	0.50	-23	12.2	-3.2	-6.0	16.5	-23.6
1.10	0.69	-45	4.03	148	0.07	22	0.50	-26	12.1	-3.3	-6.0	16.7	-23.3
1.20	0.68	-49	3.99	146	0.07	23	0.50	-28	12.0	-3.4	-6.0	16.7	-23.2
1.30	0.67	-52	3.94	143	0.07	23	0.50	-30	11.9	-3.5	-6.0	17.4	-23.0
1.40	0.67	-55	3.89	141	0.07	24	0.50	-32	11.8	-3.5	-6.1	17.3	-22.7
1.50	0.66	-59	3.83	139	0.08	25	0.50	-34	11.7	-3.6	-6.1	17.1	-22.5
1.60	0.66	-62	3.79	136	0.08	25	0.49	-36	11.6	-3.6	-6.2	16.9	-22.2
1.70	0.66	-65	3.74	134	0.08	26	0.49	-38	11.5	-3.7	-6.2	16.7	-21.9
1.80	0.66	-68	3.69	132	0.08	26	0.49	-40	11.3	-3.7	-6.2	16.5	-21.7
1.90	0.65	-71	3.63	130	0.08	26	0.49	-42	11.2	-3.7	-6.3	16.4	-21.5
2.00	0.65	-74	3.58	127	0.09	26	0.49	-44	11.1	-3.8	-6.3	16.2	-21.3
2.10	0.65	-77	3.54	125	0.09	26	0.48	-46	11.0	-3.8	-6.4	16.0	-21.1
2.20	0.64	-80	3.50	123	0.09	27	0.48	-48	10.9	-3.8	-6.5	15.9	-20.9
2.30	0.64	-82	3.43	121	0.09	26	0.48	-50	10.7	-3.9	-6.4	15.7	-20.6
2.40	0.64	-85	3.39	119	0.10	26	0.47	-52	10.6	-3.9	-6.5	15.5	-20.4
2.50	0.64	-88	3.35	117	0.10	26	0.47	-54	10.5	-3.9	-6.6	15.4	-20.3
3.00	0.63	-100	3.12	107	0.11	24	0.46	-62	9.9	-4.0	-6.8	14.7	-19.5
3.50	0.62	-112	2.91	98	0.12	22	0.44	-70	9.3	-4.2	-7.1	14.0	-18.8
4.00	0.61	-123	2.72	90	0.12	20	0.43	-78	8.7	-4.3	-7.4	13.5	-18.3
4.50	0.60	-133	2.55	82	0.13	18	0.42	-85	8.1	-4.4	-7.6	13.0	-17.9
5.00	0.60	-142	2.40	74	0.13	15	0.40	-91	7.6	-4.5	-7.9	12.6	-17.5
5.50	0.59	-151	2.27	67	0.14	13	0.39	-97	7.1	-4.6	-8.2	12.2	-17.2
6.00	0.57	-160	2.15	59	0.14	9	0.38	-109	6.6	-4.9	-8.4	11.8	-17.0
6.50	0.58	-162	1.93	49	0.14	7	0.38	-123	5.7	-4.8	-8.5	11.0	-17.3
7.00	0.56	-174	1.88	46	0.14	5	0.36	-128	5.5	-5.0	-8.8	10.0	-16.9
7.50	0.53	175	1.83	40	0.15	3	0.36	-133	5.2	-5.5	-8.9	8.9	-16.6
8.00	0.54	170	1.77	34	0.15	1	0.35	-134	4.9	-5.4	-9.1	8.6	-16.4

Freq (GHz)	NF_{min} (dB)	GAMMA Mag	OPT Ang	Rn	G_a (dB)
0.8	1.24	0.40	30	16.5	16.0
0.9	1.26	0.40	34	14.5	15.3
1.0	1.34	0.36	42	13.9	15.0
1.5	1.42	0.33	53	13.0	14.4
1.8	1.45	0.30	58	12.6	14.0
1.9	1.48	0.29	62	12.3	13.8
2.0	1.53	0.26	61	11.9	13.3
2.1	1.56	0.24	62	11.6	13.2
2.2	1.58	0.23	68	11.3	13.0
2.3	1.58	0.24	69	11.4	12.9
2.4	1.58	0.23	69	10.9	12.8
2.5	1.61	0.23	76	10.7	12.6
3.0	1.63	0.23	84	10.1	12.1
3.5	1.69	0.24	101	9.5	11.5
4.0	1.69	0.26	108	9.1	11.0
4.5	1.74	0.26	122	8.8	10.3
5.0	1.80	0.27	134	7.8	9.8
5.5	1.81	0.28	144	7.2	9.3
6.0	1.89	0.32	156	6.4	8.7

MGA-725M4 Typical Scattering Parameters and Noise Parameters

$T_c = 25^\circ\text{C}$, $V_d = 3.0\text{V}$, $I_d = 10\text{ mA}$, $Z_0 = 50\Omega$ (test circuit of Figure 2)

Freq (GHz)	S_{11} Mag.	S_{11} Ang.	S_{21} Mag.	S_{21} Ang.	S_{12} Mag.	S_{12} Ang.	S_{22} Mag.	S_{22} Ang.	S_{21} (dB)	RL _{in} (dB)	RL _{out} (dB)	G_{max} (dB)	Isolation (dB)
0.10	0.79	-9	5.57	174	0.05	19	0.48	-9	14.9	-2.0	-6.4	20.7	-26.6
0.50	0.68	-26	5.68	163	0.05	13	0.40	-15	15.1	-3.4	-8.1	18.2	-25.4
0.80	0.65	-39	5.47	154	0.06	16	0.39	-21	14.8	-3.7	-8.2	17.9	-24.9
0.90	0.66	-43	5.40	152	0.06	18	0.39	-24	14.6	-3.7	-8.2	18.0	-24.7
1.00	0.64	-46	5.33	149	0.06	19	0.39	-26	14.5	-3.9	-8.3	17.8	-24.6
1.10	0.64	-50	5.25	147	0.06	20	0.39	-28	14.4	-3.9	-8.3	17.8	-24.4
1.20	0.63	-54	5.18	144	0.06	21	0.38	-31	14.3	-4.1	-8.3	17.8	-24.2
1.30	0.63	-58	5.10	142	0.06	21	0.38	-33	14.2	-4.1	-8.4	17.9	-24.0
1.40	0.62	-61	5.03	139	0.07	22	0.38	-35	14.0	-4.2	-8.4	17.9	-23.7
1.50	0.62	-64	4.95	137	0.07	23	0.38	-37	13.9	-4.2	-8.4	18.2	-23.5
1.60	0.62	-68	4.88	134	0.07	23	0.38	-39	13.8	-4.2	-8.5	18.6	-23.3
1.70	0.61	-71	4.81	132	0.07	23	0.37	-42	13.6	-4.3	-8.5	18.4	-23.1
1.80	0.61	-74	4.73	130	0.07	24	0.37	-44	13.5	-4.3	-8.6	18.2	-23.0
1.90	0.61	-77	4.65	128	0.07	24	0.37	-46	13.4	-4.3	-8.6	18.0	-22.7
2.00	0.60	-81	4.58	125	0.07	24	0.37	-48	13.2	-4.4	-8.7	17.9	-22.6
2.10	0.60	-84	4.51	123	0.08	24	0.37	-50	13.1	-4.4	-8.7	17.7	-22.4
2.20	0.60	-87	4.45	121	0.08	24	0.36	-51	13.0	-4.5	-8.8	17.6	-22.3
2.30	0.60	-89	4.36	119	0.08	24	0.36	-54	12.8	-4.5	-8.8	17.5	-22.2
2.40	0.59	-92	4.29	117	0.08	24	0.36	-55	12.7	-4.5	-8.8	17.3	-21.9
2.50	0.59	-95	4.23	115	0.08	24	0.36	-57	12.5	-4.5	-8.9	17.2	-21.8
3.00	0.59	-108	3.91	105	0.09	23	0.35	-66	11.8	-4.6	-9.1	16.5	-21.2
3.50	0.58	-119	3.62	96	0.09	23	0.34	-73	11.2	-4.7	-9.3	15.9	-20.6
4.00	0.57	-130	3.36	88	0.10	22	0.34	-81	10.5	-4.8	-9.5	15.4	-20.3
4.50	0.57	-140	3.13	80	0.10	21	0.33	-88	9.9	-4.9	-9.6	14.9	-19.9
5.00	0.57	-149	2.93	73	0.11	20	0.33	-94	9.3	-5.0	-9.8	14.4	-19.5
5.50	0.56	-157	2.76	66	0.11	20	0.32	-100	8.8	-5.1	-9.9	14.0	-19.2
6.00	0.55	-166	2.58	57	0.11	17	0.32	-113	8.2	-5.1	-9.9	12.5	-18.9
6.50	0.55	-172	2.30	48	0.11	17	0.32	-122	7.2	-5.3	-9.9	10.5	-19.1
7.00	0.54	-179	2.25	45	0.12	17	0.31	-133	7.0	-5.4	-10.1	10.3	-18.4
7.50	0.50	170	2.19	39	0.13	16	0.31	-137	6.8	-6.0	-10.1	9.6	-17.9
8.00	0.51	164	2.09	33	0.13	15	0.31	-139	6.4	-5.8	-10.1	9.3	-17.5

Freq (GHz)	NF _{min} (dB)	GAMMA Mag	OPT Ang	Rn	G_a (dB)
0.8	1.20	0.35	36	14.5	17.5
0.9	1.20	0.35	39	11.9	16.6
1.0	1.24	0.34	48	11.5	16.5
1.5	1.28	0.29	60	10.5	15.9
1.8	1.30	0.26	64	10.2	15.4
1.9	1.31	0.24	68	10.1	15.3
2.0	1.34	0.20	66	9.5	14.6
2.1	1.36	0.19	68	9.1	14.4
2.2	1.38	0.19	74	9.0	14.2
2.3	1.40	0.19	76	9.0	14.2
2.4	1.40	0.18	75	8.7	13.9
2.5	1.40	0.18	83	8.6	13.9
3.0	1.42	0.19	91	8.1	13.4
3.5	1.47	0.20	109	7.7	12.6
4.0	1.50	0.22	117	7.3	12.1
4.5	1.54	0.23	130	7.2	11.4
5.0	1.61	0.23	144	6.6	10.9
5.5	1.64	0.25	153	6.1	10.4
6.0	1.72	0.29	167	5.7	9.8

MGA-725M4 Typical Scattering Parameters and Noise Parameters

$T_c = 25^\circ\text{C}$, $V_d = 3.0\text{ V}$, $I_d = 20\text{ mA}$, $Z_0 = 50\Omega$ (test circuit of Figure 2)

Freq (GHz)	S_{11} Mag.	S_{11} Ang.	S_{21} Mag.	S_{21} Ang.	S_{12} Mag.	S_{12} Ang.	S_{22} Mag.	S_{22} Ang.	S_{21} (dB)	RL_{in} (dB)	RL_{out} (dB)	G_{max} (dB)	Isolation (dB)
0.1	0.75	-11	6.78	174	0.04	12	0.39	-11	16.6	-2.5	-8.1	20.8	-27.1
0.5	0.62	-28	6.81	162	0.05	12	0.30	-16	16.7	-4.1	-10.4	19.1	-26.2
0.8	0.60	-42	6.53	153	0.05	16	0.30	-23	16.3	-4.4	-10.5	18.7	-25.8
0.9	0.60	-46	6.44	151	0.05	17	0.30	-26	16.2	-4.4	-10.5	18.8	-25.7
1.0	0.59	-50	6.34	148	0.05	18	0.30	-28	16.0	-4.6	-10.6	18.6	-25.5
1.1	0.58	-54	6.24	145	0.05	19	0.30	-31	15.9	-4.7	-10.6	18.5	-25.4
1.2	0.58	-58	6.14	143	0.06	20	0.29	-33	15.8	-4.8	-10.6	18.4	-25.0
1.3	0.57	-62	6.05	140	0.06	21	0.29	-36	15.6	-4.8	-10.7	18.4	-24.9
1.4	0.57	-65	5.95	138	0.06	21	0.29	-38	15.5	-4.9	-10.7	18.3	-24.7
1.5	0.57	-69	5.85	135	0.06	22	0.29	-40	15.3	-4.9	-10.8	18.2	-24.6
1.6	0.57	-72	5.75	133	0.06	23	0.29	-42	15.2	-4.9	-10.8	18.2	-24.3
1.7	0.56	-76	5.66	130	0.06	23	0.29	-45	15.0	-5.0	-10.9	18.1	-24.2
1.8	0.56	-79	5.56	128	0.06	23	0.28	-47	14.9	-5.0	-10.9	18.0	-24.0
1.9	0.56	-82	5.46	126	0.06	23	0.28	-49	14.7	-5.0	-11.0	18.0	-23.9
2.0	0.56	-86	5.36	124	0.07	24	0.28	-51	14.6	-5.1	-11.0	17.9	-23.6
2.1	0.55	-89	5.27	122	0.07	24	0.28	-53	14.4	-5.1	-11.1	17.8	-23.5
2.2	0.55	-92	5.19	119	0.07	24	0.28	-55	14.3	-5.1	-11.2	17.7	-23.3
2.3	0.55	-95	5.08	117	0.07	24	0.28	-57	14.1	-5.2	-11.2	17.5	-23.2
2.4	0.55	-98	4.99	115	0.07	24	0.28	-58	14.0	-5.2	-11.2	17.4	-23.1
2.5	0.55	-100	4.91	113	0.07	24	0.27	-60	13.8	-5.2	-11.2	17.3	-23.0
3.0	0.54	-113	4.51	104	0.08	24	0.27	-68	13.1	-5.3	-11.4	16.6	-22.4
3.5	0.54	-125	4.15	95	0.08	24	0.26	-76	12.4	-5.4	-11.6	15.7	-21.9
4.0	0.53	-135	3.84	87	0.08	24	0.26	-83	11.7	-5.5	-11.6	14.9	-21.5
4.5	0.53	-145	3.56	79	0.09	24	0.26	-89	11.0	-5.6	-11.7	14.1	-21.1
5.0	0.52	-153	3.33	72	0.09	24	0.26	-95	10.4	-5.6	-11.8	13.4	-20.7
5.5	0.52	-162	3.12	65	0.10	24	0.26	-100	9.9	-5.8	-11.8	12.7	-20.4
6.0	0.51	-169	2.91	57	0.10	24	0.26	-114	9.3	-5.8	-11.6	12.0	-19.9
6.5	0.50	-176	2.58	49	0.10	24	0.26	-124	8.2	-6.0	-11.7	10.6	-19.6
7.0	0.49	178	2.54	45	0.11	24	0.26	-135	8.1	-6.2	-11.6	10.4	-19.4
7.5	0.46	166	2.47	39	0.12	24	0.27	-134	7.9	-6.8	-11.4	9.9	-18.8
8.0	0.47	161	2.35	33	0.12	23	0.27	-138	7.4	-6.6	-11.3	9.6	-18.3

Freq (GHz)	NF_{min} (dB)	GAMMA Mag	OPT Ang	Rn	G_a (dB)
0.8	1.16	0.34	40	12.1	18.0
0.9	1.18	0.33	46	12.0	17.6
1.0	1.19	0.32	50	11.5	17.6
1.5	1.19	0.28	60	10.7	16.6
1.8	1.24	0.23	69	10.0	16.0
1.9	1.26	0.22	73	9.6	15.8
2.0	1.28	0.18	72	9.8	15.7
2.1	1.31	0.17	75	9.3	15.4
2.2	1.31	0.15	81	9.2	15.2
2.3	1.31	0.16	83	9.1	15.1
2.4	1.32	0.16	81	8.9	14.9
2.5	1.33	0.16	89	8.7	14.8
3.0	1.32	0.18	97	8.3	14.2
3.5	1.36	0.18	116	8.1	13.5
4.0	1.40	0.20	123	7.9	12.8
4.5	1.43	0.22	136	7.9	12.2
5.0	1.51	0.23	150	7.7	11.6
5.5	1.55	0.25	158	7.6	11.1
6.0	1.62	0.29	172	7.7	10.6

MGA-725M4 Typical Scattering Parameters and Noise Parameters

$T_c = 25^\circ\text{C}$, $V_d = 3.0\text{ V}$, $I_d = 40\text{ mA}$, $Z_0 = 50\Omega$ (test circuit of Figure 2)

Freq (GHz)	S_{11} Mag.	S_{11} Ang.	S_{21} Mag.	S_{21} Ang.	S_{12} Mag.	S_{12} Ang.	S_{22} Mag.	S_{22} Ang.	S_{21} (dB)	RL _{in} (dB)	RL _{out} (dB)	G _{max} (dB)	Isolation (dB)
0.1	0.75	-11	7.39	173	0.04	18	0.35	-12	17.4	-2.5	-9.2	22.1	-27.7
0.5	0.62	-29	7.38	162	0.05	11	0.26	-16	17.4	-4.1	-11.8	19.8	-26.7
0.8	0.60	-43	7.06	153	0.05	15	0.25	-23	17.0	-4.4	-12.0	19.4	-26.6
0.9	0.60	-47	6.95	150	0.05	16	0.25	-26	16.8	-4.4	-12.0	19.4	-26.4
1.0	0.59	-51	6.84	147	0.05	17	0.25	-28	16.7	-4.6	-12.0	19.1	-26.2
1.1	0.58	-55	6.73	145	0.05	18	0.25	-31	16.6	-4.7	-12.1	19.0	-26.0
1.2	0.58	-60	6.62	142	0.05	19	0.25	-33	16.4	-4.8	-12.1	18.9	-25.8
1.3	0.57	-63	6.51	140	0.05	20	0.25	-36	16.3	-4.8	-12.1	18.8	-25.7
1.4	0.57	-67	6.40	137	0.05	21	0.25	-38	16.1	-4.9	-12.2	18.7	-25.5
1.5	0.57	-71	6.29	135	0.05	22	0.25	-40	16.0	-4.9	-12.2	18.6	-25.4
1.6	0.57	-74	6.18	132	0.06	22	0.24	-42	15.8	-4.9	-12.3	18.5	-25.2
1.7	0.56	-78	6.07	130	0.06	23	0.24	-45	15.7	-5.0	-12.3	18.4	-25.0
1.8	0.56	-81	5.96	128	0.06	23	0.24	-47	15.5	-5.0	-12.4	18.3	-24.9
1.9	0.56	-85	5.85	125	0.06	24	0.24	-49	15.3	-5.0	-12.4	18.2	-24.6
2.0	0.56	-88	5.74	123	0.06	24	0.24	-51	15.2	-5.1	-12.4	18.1	-24.4
2.1	0.55	-91	5.64	121	0.06	24	0.24	-53	15.0	-5.1	-12.5	17.9	-24.3
2.2	0.55	-94	5.54	119	0.06	24	0.23	-54	14.9	-5.1	-12.6	17.7	-24.3
2.3	0.55	-97	5.43	117	0.06	25	0.24	-56	14.7	-5.2	-12.6	17.6	-24.2
2.4	0.55	-100	5.34	115	0.06	25	0.24	-58	14.5	-5.2	-12.6	17.4	-24.0
2.5	0.55	-103	5.24	113	0.06	25	0.23	-60	14.4	-5.2	-12.7	17.3	-23.9
3.0	0.54	-115	4.79	103	0.07	26	0.23	-67	13.6	-5.3	-12.8	16.6	-23.2
3.5	0.54	-127	4.40	95	0.07	26	0.23	-74	12.9	-5.4	-12.9	15.7	-22.7
4.0	0.53	-137	4.06	87	0.08	26	0.23	-81	12.2	-5.5	-12.9	14.9	-22.4
4.5	0.53	-147	3.77	79	0.08	27	0.23	-86	11.5	-5.6	-13.0	14.2	-21.9
5.0	0.52	-155	3.52	72	0.08	27	0.23	-91	10.9	-5.6	-12.9	13.5	-21.5
5.5	0.52	-164	3.30	65	0.09	28	0.23	-96	10.4	-5.8	-12.9	12.8	-21.1
6.0	0.51	-172	3.06	57	0.09	27	0.23	-112	9.7	-5.8	-12.7	12.2	-20.7
6.5	0.50	-176	2.73	49	0.09	25	0.23	-125	8.7	-6.0	-12.7	10.8	-20.8
7.0	0.49	177	2.69	46	0.10	28	0.23	-132	8.6	-6.2	-12.6	10.7	-19.9
7.5	0.46	165	2.61	40	0.11	28	0.24	-130	8.3	-6.8	-12.3	10.2	-19.3
8.0	0.47	160	2.49	34	0.12	27	0.25	-134	7.9	-6.6	-12.1	9.9	-18.7

Freq (GHz)	NF _{min} (dB)	GAMMA Mag	OPT Ang	Rn	G _a (dB)
0.8	1.23	0.36	33	14.7	19.0
0.9	1.24	0.35	42	12.4	18.2
1.0	1.27	0.35	50	11.5	18.2
1.5	1.28	0.28	63	10.3	17.3
1.8	1.32	0.25	68	10.1	16.7
1.9	1.32	0.24	72	9.9	16.4
2.0	1.37	0.22	72	9.4	16.2
2.1	1.40	0.20	74	9.2	16.0
2.2	1.40	0.21	79	9.1	15.8
2.3	1.40	0.20	82	9.0	15.7
2.4	1.40	0.20	81	8.7	15.5
2.5	1.42	0.20	88	8.6	15.4
3.0	1.43	0.22	97	8.0	14.7
3.5	1.47	0.22	115	7.5	14.0
4.0	1.51	0.24	124	7.0	13.3
4.5	1.56	0.25	138	6.7	12.7
5.0	1.65	0.26	151	6.1	12.1
5.5	1.64	0.29	160	5.6	11.6
6.0	1.77	0.32	173	5.3	11.1

MGA-725M4 Typical Scattering Parameters and Noise Parameters

$T_c = 25^\circ\text{C}$, $V_d = 3.0\text{ V}$, $I_d = 60\text{ mA}$, $Z_0 = 50\Omega$ (test circuit of Figure 2)

Freq (GHz)	S_{11} Mag.	S_{11} Ang.	S_{21} Mag.	S_{21} Ang.	S_{12} Mag.	S_{12} Ang.	S_{22} Mag.	S_{22} Ang.	S_{21} (dB)	RL_{in} (dB)	RL_{out} (dB)	G_{max} (dB)	Isolation (dB)
0.1	0.76	-11	7.09	174	0.04	17	0.35	-11	17.0	-2.4	-9.1	21.7	-28.0
0.5	0.64	-29	7.08	162	0.05	10	0.26	-15	17.0	-3.9	-11.6	19.5	-26.9
0.8	0.61	-42	6.78	153	0.05	14	0.26	-21	16.6	-4.2	-11.7	19.1	-26.7
0.9	0.62	-47	6.69	151	0.05	15	0.26	-24	16.5	-4.2	-11.8	19.0	-26.6
1.0	0.60	-50	6.58	148	0.05	17	0.26	-26	16.4	-4.4	-11.8	18.8	-26.4
1.1	0.60	-55	6.48	145	0.05	18	0.26	-28	16.2	-4.5	-11.8	18.7	-26.4
1.2	0.59	-59	6.38	143	0.05	19	0.26	-31	16.1	-4.6	-11.8	18.6	-26.2
1.3	0.59	-63	6.28	140	0.05	19	0.26	-33	16.0	-4.6	-11.9	18.5	-26.0
1.4	0.58	-66	6.17	137	0.05	20	0.25	-35	15.8	-4.7	-11.9	18.3	-25.8
1.5	0.58	-70	6.07	135	0.05	21	0.25	-37	15.7	-4.7	-11.9	18.2	-25.7
1.6	0.58	-73	5.96	133	0.05	21	0.25	-39	15.5	-4.7	-12.0	18.1	-25.5
1.7	0.58	-77	5.86	130	0.05	22	0.25	-41	15.4	-4.8	-12.0	18.0	-25.4
1.8	0.57	-80	5.76	128	0.06	22	0.25	-43	15.2	-4.8	-12.1	17.9	-25.2
1.9	0.57	-84	5.66	126	0.06	23	0.25	-45	15.1	-4.8	-12.1	17.8	-25.0
2.0	0.57	-87	5.56	123	0.06	23	0.25	-47	14.9	-4.9	-12.1	17.7	-24.9
2.1	0.57	-90	5.46	121	0.06	24	0.25	-48	14.7	-4.9	-12.2	17.5	-24.7
2.2	0.57	-93	5.36	119	0.06	24	0.24	-50	14.6	-5.0	-12.3	17.4	-24.6
2.3	0.57	-96	5.26	117	0.06	24	0.24	-52	14.4	-5.0	-12.3	17.2	-24.4
2.4	0.56	-99	5.17	115	0.06	24	0.24	-53	14.3	-5.0	-12.3	17.1	-24.3
2.5	0.56	-102	5.07	113	0.06	24	0.24	-55	14.1	-5.0	-12.3	17.0	-24.2
3.0	0.56	-115	4.65	103	0.07	25	0.24	-62	13.3	-5.1	-12.5	16.2	-23.7
3.5	0.55	-126	4.27	95	0.07	26	0.24	-69	12.6	-5.2	-12.5	15.4	-23.2
4.0	0.54	-137	3.95	87	0.07	26	0.24	-75	11.9	-5.3	-12.6	14.6	-22.9
4.5	0.54	-146	3.67	79	0.08	27	0.24	-80	11.3	-5.4	-12.6	13.9	-22.4
5.0	0.54	-155	3.42	72	0.08	28	0.24	-85	10.7	-5.4	-12.5	13.3	-22.0
5.5	0.53	-163	3.21	65	0.08	29	0.24	-90	10.1	-5.5	-12.5	12.7	-21.6
6.0	0.52	-171	2.98	57	0.09	28	0.24	-106	9.5	-5.7	-12.4	11.9	-21.2
6.5	0.51	-177	2.66	49	0.09	27	0.25	-118	8.5	-5.8	-12.1	10.7	-21.3
7.0	0.50	177	2.63	45	0.10	30	0.24	-125	8.4	-6.0	-12.4	10.5	-20.4
7.5	0.47	165	2.55	39	0.10	30	0.25	-130	8.1	-6.6	-12.0	10.0	-19.7
8.0	0.48	161	2.43	33	0.11	30	0.26	-127	7.7	-6.4	-11.8	9.8	-19.2

Freq (GHz)	NF_{min} (dB)	GAMMA Mag	OPT Ang	Rn	G_a (dB)
0.8	1.47	0.38	42	19.0	18.8
0.9	1.47	0.38	48	17.8	18.2
1.0	1.51	0.38	49	17.3	18.1
1.5	1.55	0.34	60	16.1	17.4
1.8	1.56	0.31	64	14.9	17.0
1.9	1.59	0.30	68	14.6	16.8
2.0	1.62	0.29	69	14.4	16.2
2.1	1.65	0.28	71	14.3	16.0
2.2	1.66	0.28	76	14.2	15.8
2.3	1.67	0.27	78	14.1	15.7
2.4	1.67	0.27	79	13.9	15.5
2.5	1.70	0.27	84	13.6	15.4
3.0	1.70	0.27	96	12.9	14.7
3.5	1.76	0.29	113	12.7	14.0
4.0	1.83	0.31	124	12.4	13.4
4.5	1.90	0.32	137	12.2	12.7
5.0	2.00	0.34	150	11.8	12.2
5.5	2.05	0.36	159	11.7	11.7
6.0	2.19	0.39	173	11.6	11.2

MGA-725M4 Typical Scattering Parameters — Zero Bias

$T_c = 25^\circ\text{C}$, $V_d = 0\text{V}$, $I_d = 0\text{mA}$, $Z_0 = 50\Omega$ (test circuit of Figure 2)

Freq (GHz)	S_{11} Mag.	S_{11} Ang.	S_{21} Mag.	S_{21} Ang.	S_{12} Mag.	S_{12} Ang.	S_{22} Mag.	S_{22} Ang.	S_{21} (dB)	RL_{in} (dB)	RL_{out} (dB)	Isolation (dB)
0.1	0.07	-116	0.04	10	0.04	10	0.83	179	-27.3	-23.2	-1.6	-27.3
0.5	0.31	-136	0.06	28	0.06	29	0.85	176	-24.7	-10.2	-1.4	-24.7
0.8	0.42	-143	0.07	30	0.07	30	0.85	174	-22.9	-7.5	-1.4	-22.9
1.2	0.52	-154	0.09	28	0.09	28	0.85	171	-21.4	-5.6	-1.4	-21.4
1.6	0.58	-163	0.09	26	0.09	26	0.85	168	-20.5	-4.7	-1.4	-20.5
2.0	0.62	-170	0.10	24	0.10	25	0.85	165	-20.0	-4.2	-1.4	-19.9
2.4	0.64	-176	0.11	24	0.11	24	0.85	162	-19.5	-3.8	-1.4	-19.5
2.8	0.66	178	0.11	23	0.11	23	0.85	159	-19.2	-3.6	-1.4	-19.1
3.2	0.67	173	0.12	23	0.12	23	0.85	156	-18.7	-3.4	-1.4	-18.7
3.6	0.69	168	0.12	23	0.12	23	0.85	153	-18.3	-3.3	-1.5	-18.3
3.8	0.69	166	0.12	23	0.13	23	0.85	151	-18.1	-3.2	-1.5	-18.1
4.0	0.69	163	0.13	23	0.13	23	0.84	149	-17.9	-3.2	-1.5	-17.9
4.4	0.70	159	0.13	22	0.13	23	0.84	146	-17.5	-3.1	-1.5	-17.5
4.8	0.71	154	0.14	22	0.14	22	0.84	143	-17.0	-3.0	-1.5	-17.0
5.2	0.72	150	0.15	22	0.15	22	0.84	139	-16.5	-2.9	-1.5	-16.5
5.6	0.72	145	0.16	20	0.16	21	0.83	135	-16.0	-2.8	-1.6	-16.0
6.0	0.72	142	0.16	17	0.16	17	0.83	135	-15.7	-2.9	-1.6	-15.7

Ordering Information

Part Number	Devices Per Container	Container
MGA-725M4-TR1	3000	7" Reel
MGA-725M4-TR2	10000	13" Reel
MGA-725M4-BLK	100	antistatic bag

MiniPak Package Outline Drawing

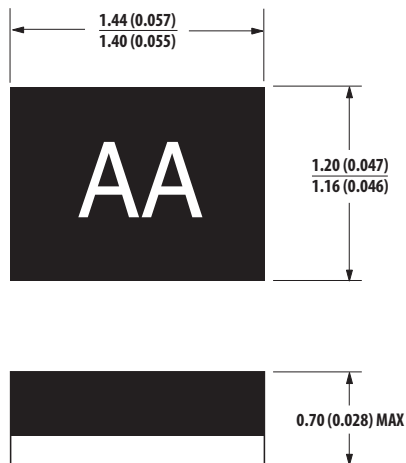

Solder Pad Dimensions

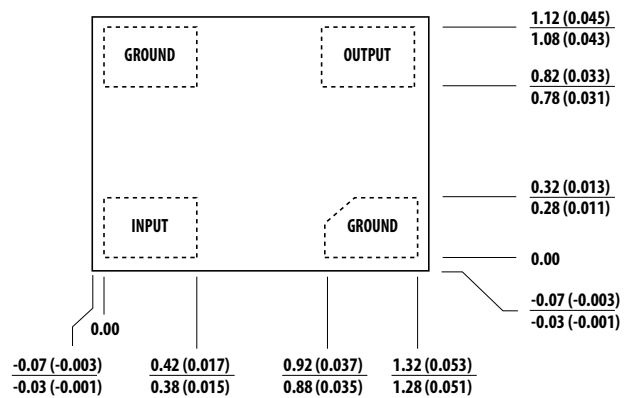

Note: Pad orientation is shown as viewed from top of package.

Package 4T — MiniPak 1412
Device Orientation

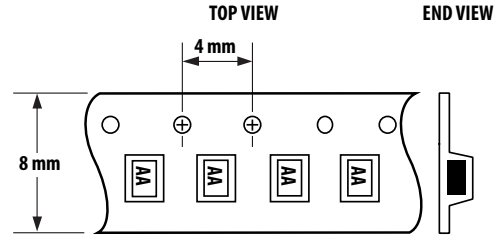
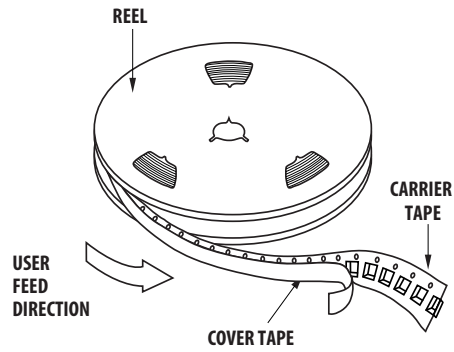

Note: "AA" represents package marking code. Package marking is right side up with carrier tape perforations at top. Conforms to Electronic Industries RS-481, "Taping of Surface Mounted Components for Automated Placement." Standard quantity is 3,000 devices per reel.

Tape Dimensions
For Outline 4T

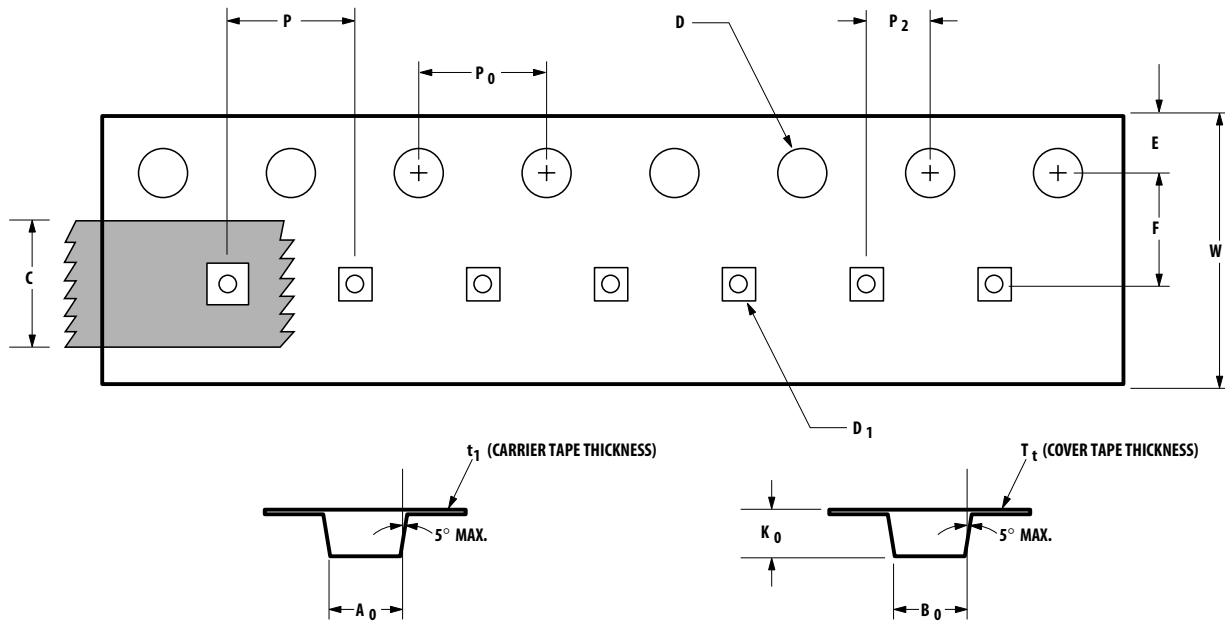

DESCRIPTION		SYMBOL	SIZE (mm)	SIZE (INCHES)
CAVITY	LENGTH	A ₀	1.40 ± 0.05	0.055 ± 0.002
	WIDTH	B ₀	1.63 ± 0.05	0.064 ± 0.002
	DEPTH	K ₀	0.80 ± 0.05	0.031 ± 0.002
	PITCH	P	4.00 ± 0.10	0.157 ± 0.004
	BOTTOM HOLE DIAMETER	D ₁	0.80 ± 0.05	0.031 ± 0.002
PERFORATION	DIAMETER	D	1.50 ± 0.10	0.060 ± 0.004
	PITCH	P ₀	4.00 ± 0.10	0.157 ± 0.004
	POSITION	E	1.75 ± 0.10	0.069 ± 0.004
CARRIER TAPE	WIDTH	W	8.00 + 0.30 - 0.10	0.315 + 0.012 - 0.004
	THICKNESS	t ₁	0.254 ± 0.02	0.010 ± 0.001
COVER TAPE	WIDTH	C	5.40 ± 0.10	0.213 ± 0.004
	TAPE THICKNESS	T _t	0.062 ± 0.001	0.002 ± 0.00004
DISTANCE	CAVITY TO PERFORATION (WIDTH DIRECTION)	F	3.50 ± 0.05	0.138 ± 0.002
	CAVITY TO PERFORATION (LENGTH DIRECTION)	P ₂	2.00 ± 0.05	0.079 ± 0.002

Application Information: Designing with the MGA-725M4 RFIC Amplifier/Bypass Switch

Description

The MGA-725M4 is a single stage GaAs RFIC amplifier with an integrated bypass switch. A functional diagram of the MGA-725M4 is shown in Figure 1.

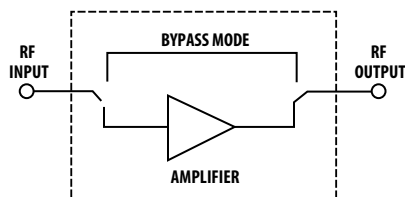

Figure 1. MGA-725M4 Functional Diagram.

The MGA-725M4 is designed for receivers and transmitters operating from 100 MHz to 6 GHz with an emphasis on 800 MHz and 1.9 GHz CDMA applications. The MGA-725M4 combines low noise performance with high linearity to make it especially advantageous for use in receiver front-ends.

The purpose of the switch feature is to prevent distortion of high signal levels in receiver applications by bypassing the amplifier altogether. The bypass switch can be thought of as a 1-bit digital AGC circuit that not only prevents distortion by bypassing the MGA-725M4 amplifier, but also reduces front-end system gain by approximately 16 dB to avoid overdriving subsequent stages in the receiver such as the mixer.

An additional feature of the MGA-725M4 is the ability to externally set device current to balance output power capability and high linearity with low DC power consumption. The adjustable current feature of the MGA-725M4 allows it to deliver output power levels in excess of +15 dBm (P_{1dB}), thus extending its use to other system applications such as transmitter driver stages.

The MGA-725M4 is designed to operate from a +3-volt power supply and is contained in miniature Minipak 1412 package to minimize printed circuit board space.

LNA Application

For low noise amplifier applications, the MGA-725M4 is typically biased in the 10–20 mA range. Minimum NF occurs at 20 mA as noted in the performance curve of NF_{min} vs I_{dr} . Biasing at currents significantly less than 10 mA is not recommended since the characteristics of the device begin to change very rapidly at lower currents.

The MGA-725M4 is matched internally for low NF. Over a current range of 10–30 mA, the magnitude of G_{opt} at 1900 MHz is typically less than 0.25 and additional impedance matching would only net about 0.1 dB improvement in noise figure.

Without external matching, the input return loss for the MGA-725M4 is approximately 5 dB at 1900 MHz. If desired, a small amount of NF can be traded off for a significant improvement in input match. For example, the addition of a series inductance of 2.7 to 3.9 nH at the input of the MGA-725M4 will improve the input return loss to greater than 10 dB with a sacrifice in NF of only 0.1 dB.

The output of the MGA-725M4 is internally matched to provide an output SWR of approximately 2:1 at 1900 MHz. Input and output matches both improve at higher frequencies.

Driver Amplifier Applications

The flexibility of the adjustable current feature makes the MGA-725M4 suitable for use in transmitter driver stages. Biasing the amplifier at 40–50 mA enables it to deliver an output power at 1 dB gain compression of up to +16 dBm. Power efficiency in the unsaturated driver mode is on the order of 30%. If operated as a saturated amplifier, both output power and efficiency will increase.

Since the MGA-725M4 is internally matched for low noise figure, it may be desirable to add external impedance matching at the input to improve the power match for driver applications. Since the reactive part of the input of the device impedance is capacitive, a series inductor at the input is often all that is needed to provide a suitable match for many applications. For 1900 MHz circuits, a series inductance of 3.9 nH will match the input to return loss of approximately 13 dB. As in the case of low noise bias levels, the output of the MGA-725M4 is already well matched to 50 Ω and no additional matching is needed for most applications.

When used for driver stage applications, the bypass switch feature of the MGA-725M4 can be used to shut down the amplifier to conserve supply current during non-transmit period. Supply current in the bypass stage is nominally 2 mA.

Biasing

Biasing the MGA-725M4 is similar to biasing a discrete GaAs FET. Passive biasing of the MGA-725M4 may be accomplished by either of two conventional methods, either by biasing the gate or by using a source resistor.

Gate Bias

Using this method, Pins 1 and 3 of the amplifier are DC grounded and a negative bias voltage is applied to Pin 2 as shown in figure 2. This method has the advantage of not only DC, but also RF grounding both of the ground pins of the MGA-725M4. Direct RF grounding of device's ground pins results in slightly improved performance while decreasing potential instabilities, especially at higher frequencies. The disadvantage is that a negative supply voltage is required.

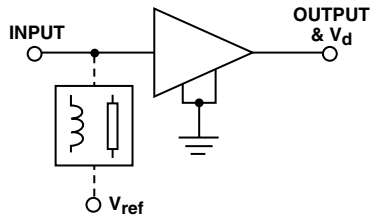

Figure 2. Gate Bias Method.

DC access to the input terminal for applying the gate bias voltage can be made through either a RF or high impedance transmission line as indicated in Figure 2.

The device current, I_d , is determined by the voltage at V_{ref} (Pin 2) with respect to ground. A plot of typical I_d vs V_{ref} is shown in Figure 3. Maximum device current (approximately 65 mA) occurs at $V_{ref} = 0$.

The device current may also be estimated from the following equation:

$$V_{ref} = 0.11 \sqrt{I_d} - 0.96$$

where I_d is in mA and V_{ref} is in volts.

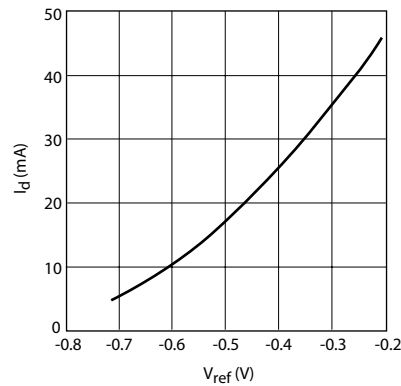

Figure 3. Device Current vs. V_{ref} .

The gate bias method would not normally be used unless a negative supply voltage was readily available. For reference, this is the method used in the characterization test circuits shown in Figures 1 and 2 of the MGA-725M4 data sheet.

Source Resistor Bias

The source resistor method is the simplest way of biasing the MGA-725M4 using a single, positive supply voltage. This method, shown in Figure 4, places the RF input at DC ground and requires both of the device grounds to be RF bypassed. Device current, I_d , is determined by the value of the source resistance, R_{bias} , between either Pin 1 and Pin 3 of the MGA-725M4 and DC ground. Pin 1 and Pin 3 are connected internally in the RFIC. Maximum device current (approximately 65 mA) occurs for $R_{bias} = 0\Omega$.

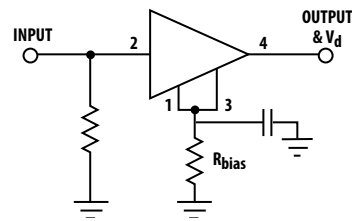

Figure 4. Source Resistor Bias.

A simple method recommended for DC grounding the input terminal is to merely add a resistor from Pin 2 to ground, as shown in Figure 4. The value of the shunt R can be comparatively high since the only voltage drop across it is due to minute leakage currents that in the mA range. A value of $1k\Omega$ would adequately DC ground the input while loading the RF signal by only 0.2 dB loss. A plot of typical I_d vs R_{bias} is shown in Figure 5.

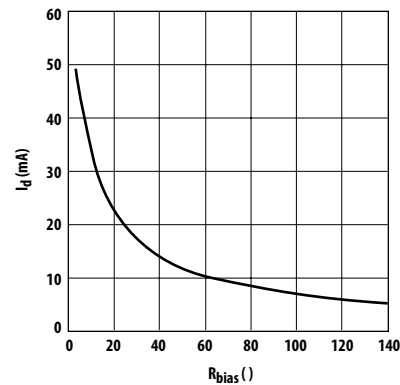

Figure 5. Device Current vs. R_{bias} .

The approximate value of the external resistor, R_{bias} , may also be calculated from:

$$R_{bias} = \frac{964}{I_d} (1 - 0.112 \sqrt{I_d})$$

where R_{bias} is in ohms and I_d is the desired device current in mA. The source resistor technique is the preferred and most common method of biasing the MGA-725M4.

Adaptive Biasing

For applications in which input power levels vary over a wide range, it may be useful to dynamically adapt the bias of the MGA-725M4 to match the signal level. This involves sensing the signal level at some point in the system and automatically adjusting the bias current of the amplifier accordingly. The advantage of adaptive biasing is conservation of supply current (longer battery life) by using only the amount of current necessary to handle the input signal without distortion.

Adaptive biasing of the MGA-725M4 can be accomplished by either analog or digital means. For the analog control case, an active current source (discrete device or IC) is used in lieu of the source bias resistor. For simple digital

control, electronic switches can be used to control the value of the source resistor in discrete increments. Both methods of adaptive biasing are depicted in Figure 6.

Applying the Device Voltage

Common to all methods of biasing, voltage V_d is applied to the MGA-725M4 through the RF Output connection (Pin 4). A RF choke is used to isolate the RF signal from the DC supply. The bias line is capacitively bypassed to keep RF from the DC supply lines and prevent resonant dips or peaks in the response of the amplifier. Where practical, it may be cost effective to use a length of high impedance transmission line (Preferably $\lambda/4$) in place of the RFC.

When using the gate bias method, the overall device voltage is equal to the sum of V_{ref} at Pin 2 and voltage V_d at Pin 4. As an example, to bias the device at the typical operating voltage of 3 volts, V_d would be set to 2.5 volts for a V_{ref} of -0.5 volts. Figure 7 shows a DC schematic of a gate bias circuit.

Just as for the gate bias method, the overall device voltage for source resistor biasing is equal to $V_{ref} + V_d$. Since V_{ref} is zero when using a source resistor, V_d is the same as the device operating voltage, typically 3 volts. A source resistor bias circuit is shown in Figure 8.

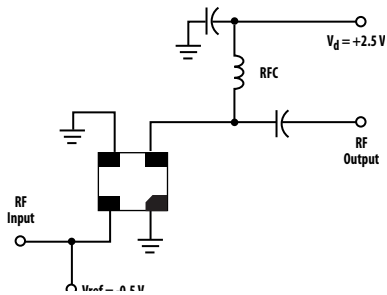

Figure 7. DC Schematic for Gate Bias.

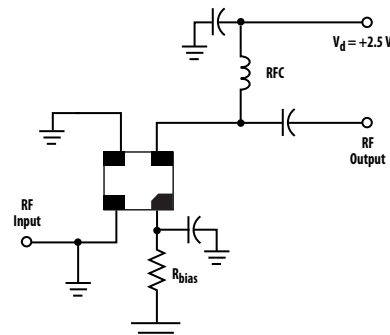

Figure 8. DC Schematic of Source Resistor Biasing.

A DC blocking capacitor at the output of the RFIC isolates the supply voltage from succeeding circuits. If the source resistor method of biasing is used, the RF input terminal of the MGA-725M4 is at DC ground potential and a blocking capacitor is not required unless the input is connected directly to a preceding stage that has a DC voltage present.

Biasing for Higher Linearity or Output Power

While the MGA-725M4 is designed primarily for use up to 50 mA in 3 volt applications, the output power can be increased by using higher currents and/or higher supply voltages. If higher bias levels are used, appropriate caution should be observed for both the thermal limits and the Absolute Maximum Ratings.

As a guideline for operation at higher bias levels, the Maximum Operating conditions shown in the data sheet table of Absolute Maximum Ratings should be followed. This set of conditions is the maximum combination of bias voltage, bias current, and device temperature that is recommended for reliable operation. Note: In contrast to Absolute Maximum Ratings, in which exceeding may one parameter may result in damage to the device, all of the Maximum Operating conditions may reliably be applied to the MGA-725M4 simultaneously.

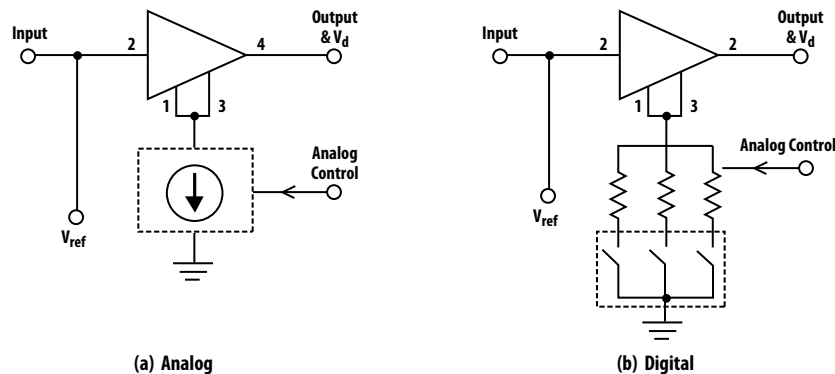

Figure 6. Adaptive Bias Control.

Controlling the Switch

The state of the MGA-725M4 (amplifier or bypass mode) is controlled by the device current. For device currents greater than 5 mA, the MGA-725M4 functions as an amplifier. If the device current is set to zero, the MGA-725M4 is switched into bypass mode in which the amplifier is turned off and the signal is routed around the amplifier with a loss of approximately 2.5 dB.

The bypass state is normally engaged in the presence of high input levels to prevent distortion of the signal that might occur in the amplifier. In the bypass state the input TOI is very high, typically +39 dBm at 1900 MHz.

The simplest method of placing the MGA-725M4 into the bypass mode is to open-circuit the ground terminals at Pins 1 and 3. With the ground connection open, the internal control circuit of the MGA-725M4 auto-switches from the amplifier mode into a bypass state and the device current drops to near zero. Nominal current in the bypass state is 2 μ A with a maximum of 15 μ A.

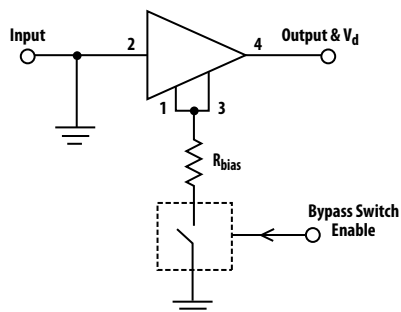

Figure 9. MGA-725M4 Amplifier/Bypass State Switching.

An electronic switch can be used to control states as shown in Figure 9. The control switch could be implemented with either a discrete transistor or simple IC.

The speed at which the MGA-725M4 switches between states is extremely fast and will normally be limited by the time constants of external circuit components, such as the bias circuit and the bypass and blocking capacitors.

The input and output of the MGA-725M4 while in the bypassed state are internally matched to 50 Ω . The input return loss can be further improved at 1900 MHz by adding a 2.9 to 3.9 nH series inductor added to the input. This is the same approximate value of inductor that is used to improve input match when the MGA-725M4 is in the amplifier state.

Thermal Considerations

Good thermal design is always an important consideration in the reliable use of any device, since the Mean Time To Failure (MTTF) of semiconductors is inversely proportional to the operating temperature.

The MGA-725M4 is a comparatively low power dissipation device. When biased at 3 volts and 20 mA for LNA application, the power dissipation is 3.0 volts x 20 mA or 60 mW. The temperature increment from the RFIC channel to its case is then 0.060 watt x 200 $^{\circ}$ C/Watt, or only 12 $^{\circ}$ C. Subtracting the channel to case temperature rise from the suggested maximum junction temperature of 150 $^{\circ}$ C, the resulting maximum allowable case temperature is 138 $^{\circ}$ C.

The worst case thermal situation occurs when the MGA-725M4 is operated at its Maximum Operating Conditions in an effort to maximize output power or to achieve minimum distortion. A similar calculation for the Maximum Operating bias of 4.2 volts and 60 mA yields a maximum allowable case temperature of 100 $^{\circ}$ C. This calculation further assumes the worst case of no RF power being extracted from the device. When operated in a saturated mode, both power added efficiency and the maximum allowable case temperature will increase.

Note "Case" temperature for surface mount packages such as the SOT-343 refers to the interface between the package pins and the mounting surface, i.e., the temperature at the PCB mounting pad. The primary heat path from the RFIC chip to the system heat sink is by means of conduction through the package leads and ground vias to the ground plane of the PCB.

PCB Layout and Grounding

When laying out a printed circuit board for the MGA-725M4, several points should be considered. Of primary concern is the RF bypassing of the ground terminals when the device is biased using the source resistor method.

Package Footprint

A suggested PCB pad print for the miniature, Minipak 1412 package used by the MGA-725M4 is shown in Figure 10.

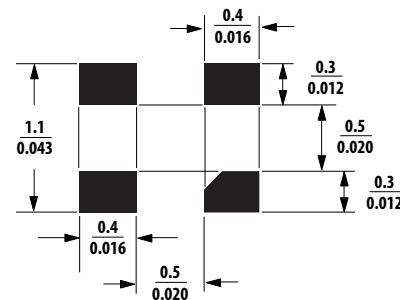

Figure 10. PCB Pad Print for Minipak 1412 Package (mm [inches]).

This pad print provides allowance for package placement by automated assembly equipment without adding excessive parasitics that could impair the high frequency performance of the MGA-725M4. The layout is shown with a footprint of the MGA-725M4 superimposed on the PCB pads for reference.

RF Bypass

For layouts using the source resistor method of biasing, both of the ground terminals of the MGA-725M4 must be well by-passed to maintain device stability.

Beginning with the package pad print in Figure 10, a RF layout similar to the one shown in Figure 11 is a good starting point for using the MGA-725M4 with capacitor-bypassed ground terminals. It is a best practice to use multiple vias to minimize overall ground path inductance.

Two capacitors are used at each of the PCB pads for both Pins 1 and 3. The value of the bypass capacitors is a balance between providing a small reactance for good RF grounding, yet not being so large that the capacitor's parasitics introduce undesirable resonances or loss.

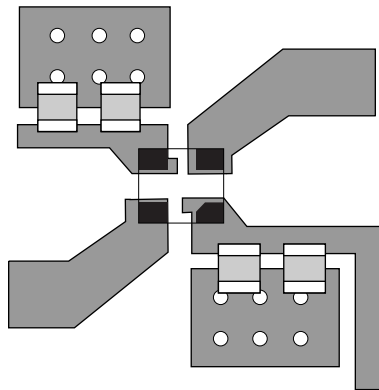

Figure 11. Layout for RF Bypass.

If the source resistor biasing method is used, a ground pad located near either Pin 1 or Pin 3 may be used to connect the current-setting resistor (R_{bias}) directly to DC ground. If the R_{bias} resistor is not located immediately adjacent to the MGA-725M4 (as may be the case of dynamic control of the device's linearity), then a small series resistor (e.g. 10Ω) located near the ground terminal will help de-Q the connection from the MGA-725M4 to an external current-setting circuit.

PCB material

FR-4 or G-10 type dielectric materials are typical choices for most low cost wireless applications using single or multi-layer printed circuit boards. The thickness of single-layer boards usually range from 0.020 to 0.031 inches. Circuit boards should be constructed so that distance to ground for RF signals are less than 0.031 inches. Using PCB layer stacks that are greater than this are not recommended due to excessive inductance in the vias.

Application Example

An example evaluation PCB layout for the MGA-725M4 is shown in Figure 12. This evaluation circuit is designed for operation from a +3-volts supply and includes provision for a 2-bit DIP switch to set the state of the MGA-725M4. For evaluation purposes, the 2-bit switch is used to set the device to either of four states: (1) bypass mode-switch bypasses the amplifier, (2) low noise amplifier mode-low bias current, (3) and (4) driver amplifier modes-high bias currents.

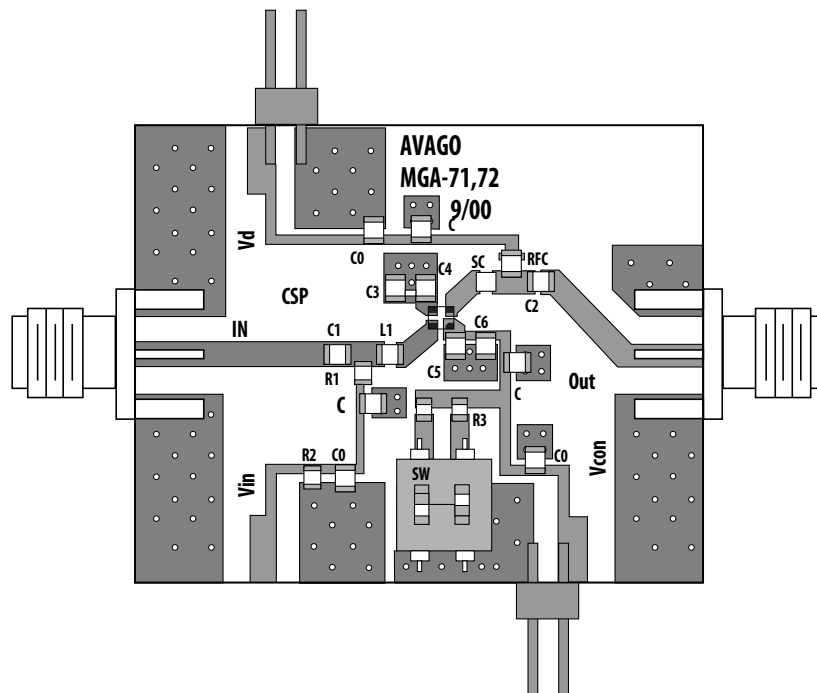

Figure 13. Complete Amplifier with Component Reference Designators.

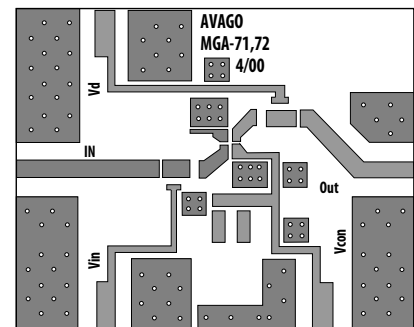

Figure 12. PCB Layout for Evaluation Circuit.

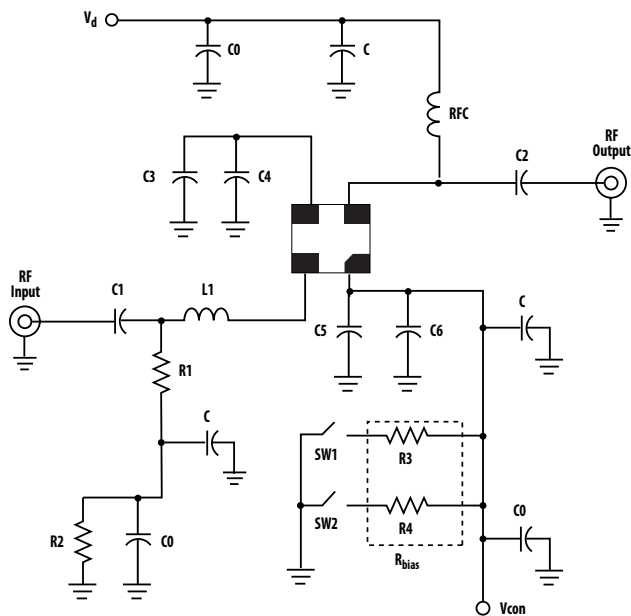

Figure 14. Schematic Diagram of 1900 MHz Evaluation Amplifier.

A complete evaluation amplifier optimized for use at 1900 MHz is shown with all related components and SMA connectors in Figure 13. A schematic diagram of the evaluation circuit is shown in Figure 14 with component values in Table 1.

Table 1. Component Values for 1900 MHz Amplifier.

R1	=5.1 k Ω	C	=100pF
R2	=5.1k Ω	C0	=1000pF
R3	=10 Ω	C1	=100pF
R4	=24 Ω	C2	=47pF
L1	=3.9nH	C3	=30pF
RFC	=22nH	C4	=22pF
SW1, SW2	DIP switch	C5	=22pF
SC	Short	C6	=30pF

The on-board resistors R3 and R4 form the equivalent source bias resistor R_{bias} as indicated in the schematic diagram in Figure 14. In this example, resistor values of $R3=10\Omega$ and $R4=24\Omega$ were chosen to set the nominal device current for the four states: (1) bypass mode, 0 mA, (2) LNA mode, 20 mA, (3) driver, 35 mA, and (4) driver, 40 mA.

Other currents can be set by positioning the DIP switch to the bypass state and adding an external bias resistor to V_{con} . Unless an external resistor is used to set the current, the V_{con} terminal is left open. DC blocking capacitors are provided for the both the input and output.

The 2-pin, 0.100" centerline single row headers attached to the V_d and V_{con} connections on the PCB provide a convenient means of making connections to the board using either a mating connector or clip leads.

A Note on Performance

Actual performance of the MGA-725M4 as measured in an evaluation circuit may not exactly match the datasheet specifications. The circuit board material, passive components, RF bypasses and connectors all introduce losses and parasitics that degrade device performance.

For the evaluation circuit above, fabricated on 0.031-inch thick GETEK G200D ($\epsilon_r=4.2$) dielectric material, circuit losses of about 0.3 dB would be expected at both the input and output sides of the RFIC at 1900 MHz. Measured noise figure (3 volts, 20 mA bias) would then be approximately 1.8 dB and gain 13.8 dB.

Hints and Troubleshooting

Preventing Oscillation

Stability of the MGA-725M4 is dependent on having very good RF grounding. Inadequate device grounding or poor PCB layout techniques could cause the device to be potentially unstable.

Even though a design may be unconditionally stable ($K>1$ and $B1>0$) over its full frequency range, other possibilities exist that may cause an amplifier circuit to oscillate. One condition to check for is feedback in the bias circuit. It is important to capacitively bypass the connections to active bias circuits to ensure stable operation. In multi-stage circuits, feedback through bias lines can also lead to oscillation.

Components of insufficient quality for the frequency range of the amplifier can sometimes lead to instability. Also, component values that are chosen to be much higher in value than is appropriate for the application can present a problem. In both of these cases, the components may have reactive parasitics that make their impedances very different than expected. Chip capacitors may have excessive inductance or chip inductors can exhibit resonances at unexpected frequencies.

A Note on Supply Line Bypassing

Multiple bypass capacitors are normally used throughout the power distribution within a wireless system. Consideration should be given to potential resonances formed by the combination of these capacitors and the inductance of the DC distribution lines. The addition of a small value resistor in the bias supply line between bypass capacitors will often de-Q the bias circuit and eliminate resonance effects.

Statistical Parameters

Several categories of parameters appear within the electrical specification portion of the MGA-725M4 data sheet. Parameters may be described with values that are either “minimum or maximum”, “typical” or “standard deviation”.

The values for parameters are based on comprehensive product characterization data, in which automated measurements are made on a statistically significant number of parts taken from nonconsecutive process lots of semiconductor wafers. The data derived from product characterization tends to be normally distributed, e.g., fits the standard bell curve.

Parameters considered to be the most important to system performance are bounded by minimum or maximum values. For the MGA-725M4, these parameters are: $V_{c\text{ test}}$, $NF_{\text{ test}}$, $G_{a\text{ test}}$, $IIP3_{\text{ test}}$, and $IL_{\text{ test}}$. Each of the guaranteed parameters is 100% tested as part of normal manufacturing and test process.

Values for most of the parameters in the table of Electrical Specifications that are described by typical data are mathematical mean (μ), of the normal distribution taken from the characterization data. For parameters where measurements of mathematical averaging may not be practical, such as S-parameters or Noise Parameters and the performance curve, the data represents a nominal part taken from the center of the characterization distribution. Typical values are intended to be used as a basis for electrical design.

To assist designers in optimizing not only the immediate amplifier circuit using the MGA-725M4, but to also evaluate and optimize trade-offs that affect a complete wireless system, the standard deviation (σ) is provided for many of the Electrical Specification parameters (at 25°C). The standard deviation is a measure of variability about the mean. It will be recalled that a normal distribution is completely described by the mean and standard deviation.

Standard statistics tables or calculations provide the probability of a parameter falling between any two values, usually symmetrically located about the mean. Referring to Figure 15 for example, the probability of a parameter being between $\pm 1\sigma$ is 68.3%; between $\pm 2\sigma$ is 95.4%; and between $\pm 3\sigma$ is 99.7%.

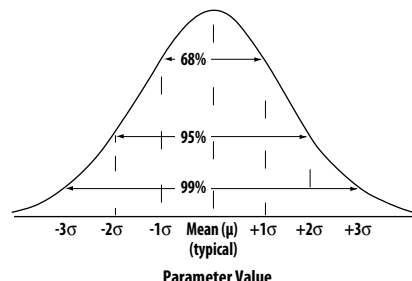

Figure 15. Normal Distribution Curve.

Phase Reference Planes

The positions of the reference planes used to specify S-parameters and Noise Parameters for the MGA-725M4 are shown in Figure 16. As seen in the illustration, the reference planes are located at centre of package solder pads.

S and Noise Parameter data was taken with the package mounted to 50 ohm lines on 10 mil alumina substrates, and the ground pads were connected directly to the substrate ground plane through a solid metal rib. Designers should include the parasitics of the grounding system used in their application.

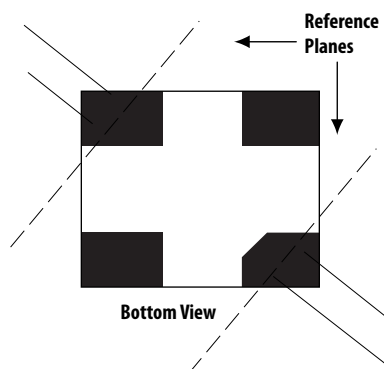

Figure 16. Phase Reference Planes.

For product information and a complete list of distributors, please go to our web site: www.avagotech.com

Avago, Avago Technologies, and the A logo are trademarks of Avago Technologies, Limited in the United States and other countries. Data subject to change. Copyright © 2005-2008 Avago Technologies, Limited. All rights reserved. Obsoletes 5989-4191EN AV02-112xEN - April 9, 2008

AVAGO
TECHNOLOGIES