

FEATURES

Tiny 3.35 mm × 2.50 mm × 0.88 mm surface-mount package
High SNR of 62 dBA
High sensitivity of –38 dBV
Flat frequency response from 200 Hz to 15 kHz
Low current consumption: <250 μA
Single-ended analog output
High PSRR of 70 dB
Compatible with Sn/Pb and Pb-free solder processes
RoHS/WEEE compliant

APPLICATIONS

Smartphones and feature phones
Teleconferencing systems
Digital video cameras
Bluetooth headsets
Video phones
Tablets

GENERAL DESCRIPTION

The **ADMP405** is a high quality, high performance, low power, analog output, bottom-ported omnidirectional MEMS microphone. The **ADMP405** consists of a MEMS microphone element, an impedance converter, and an output amplifier. The **ADMP405** sensitivity specification makes it an excellent choice for both near field and far field applications. The **ADMP405** has a high SNR and flat wideband frequency response, resulting in natural sound with high intelligibility. The specially designed low frequency cutoff reduces wind noise. Low current consumption enables long battery life for portable applications. A built-in particle filter provides high reliability. The **ADMP405** complies with the TIA-920 *Telecommunications Telephone Terminal Equipment Transmission Requirements for Wideband Digital Wireline Telephones* standard.

The **ADMP405** is available in an ultraminiature 3.35 mm × 2.50 mm × 0.88 mm surface-mount package. It is reflow solder compatible with no sensitivity degradation. The **ADMP405** is halide free.

FUNCTIONAL BLOCK DIAGRAM

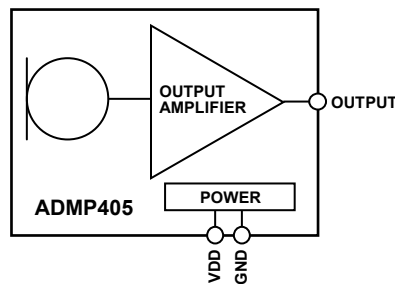

Figure 1.

09027-001

Rev. B

Information furnished by Analog Devices is believed to be accurate and reliable. However, no responsibility is assumed by Analog Devices for its use, nor for any infringements of patents or other rights of third parties that may result from its use. Specifications subject to change without notice. No license is granted by implication or otherwise under any patent or patent rights of Analog Devices. Trademarks and registered trademarks are the property of their respective owners.

TABLE OF CONTENTS

Features 1
 Applications..... 1
 General Description 1
 Functional Block Diagram 1
 Revision History 2
 Specifications..... 3
 Absolute Maximum Ratings..... 4
 ESD Caution..... 4
 Pin Configuration and Function Descriptions..... 5
 Typical Performance Characteristics 6
 Applications Information 7

Connecting to Analog Devices, Inc., Audio Codecs7
 Supporting Documents7
 PCB Land Pattern Layout.....8
 Handling Instructions.....9
 Pick-and-Place Equipment9
 Reflow Solder9
 Board Wash9
 Reliability Specifications..... 10
 Outline Dimensions 11
 Ordering Guide 11

REVISION HISTORY

9/11—Rev. A to Rev. B

Changes to Figure 1 1
 Changes to Supply Voltage Parameter, Table 1 3
 Changes to Table 3..... 4
 Added Connecting to Analog Devices, Inc., Audio Codecs
 Section and Supporting Documents Section..... 7
 Changes to Pick and Place Equipment Section
 (20 kg to 10 kg)..... 9
 Added LGA_CAV Tape and Reel Outline Dimensions,
 Figure 12 11

2/11—Rev. 0 to Rev. A

Changes to Applications Section and
 General Description Section.....1
 Change to Table 13
 Changes to Table 2.....4

7/10—Revision 0: Initial Version

SPECIFICATIONS

$T_A = 25^\circ\text{C}$, $V_{DD} = 1.8\text{ V}$, unless otherwise noted. All minimum and maximum specifications are guaranteed. Typical specifications are not guaranteed.

Table 1.

Parameter	Symbol	Test Conditions/Comments	Min	Typ	Max	Unit
PERFORMANCE						
Directionality				Omni		
Sensitivity		1 kHz, 94 dB SPL	-41	-38	-35	dBV
Signal-to-Noise Ratio	SNR			62		dB
Equivalent Input Noise	EIN			32		dB SPL
Dynamic Range		Derived from EIN and maximum acoustic input		88		dB
Frequency Response ¹		Low frequency -3 dB point		200		Hz
		High frequency -3 dB point		15		kHz
		Deviation limits from flat response within pass band		-3/+2		dB
Total Harmonic Distortion	THD	105 dB SPL			3	%
Power Supply Rejection Ratio	PSRR	217 Hz, 100 mV p-p square wave superimposed on $V_{DD} = 1.8\text{ V}$		70		dB
Maximum Acoustic Input		Peak		120		dB SPL
POWER SUPPLY						
Supply Voltage	V_{DD}		1.5		3.3	V
Supply Current	I_S				250	μA
OUTPUT CHARACTERISTICS						
Output Impedance	Z_{OUT}			200		Ω
Output DC Offset				0.8		V
Output Current Limit				90		μA

¹ See Figure 4 and Figure 6.

ABSOLUTE MAXIMUM RATINGS

Table 2.

Parameter	Rating
Supply Voltage	-0.3 V to 3.6 V
Sound Pressure Level (SPL)	160 dB
Mechanical Shock	10,000 g
Vibration	Per MIL-STD-883 Method 2007, Test Condition B
Temperature Range	-40°C to +70°C

Stresses above those listed under Absolute Maximum Ratings may cause permanent damage to the device. This is a stress rating only; functional operation of the device at these or any other conditions above those indicated in the operational section of this specification is not implied. Exposure to absolute maximum rating conditions for extended periods may affect device reliability.

ESD CAUTION



ESD (electrostatic discharge) sensitive device. Charged devices and circuit boards can discharge without detection. Although this product features patented or proprietary protection circuitry, damage may occur on devices subjected to high energy ESD. Therefore, proper ESD precautions should be taken to avoid performance degradation or loss of functionality.

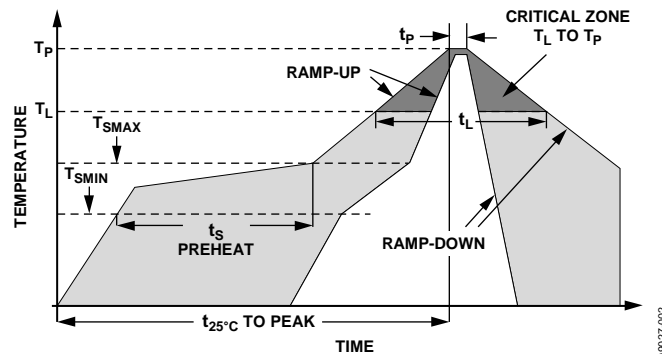
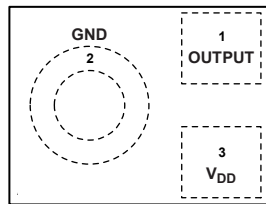

Figure 2. Recommended Soldering Profile Limits

Table 3. Recommended Soldering Profile Limits

Profile Feature	Sn63/Pb37	Pb Free
Average Ramp Rate (T_L to T_P)	1.25°C/sec max	1.25°C/sec max
Preheat		
Minimum Temperature (T_{SMIN})	100°C	150°C
Maximum Temperature (T_{SMAX})	150°C	200°C
Time (T_{SMIN} to T_{SMAX}), t_s	60 sec to 75 sec	60 sec to 75 sec
Ramp-Up Rate (T_{SMAX} to T_L)	1.25°C/sec	1.25°C/sec
Time Maintained Above Liquidous (t_L)	45 sec to 75 sec	~50 sec
Liquidous Temperature (T_L)	183°C	217°C
Peak Temperature (T_P)	215°C + 3°C/-3°C	245°C + 0°C/-5°C
Time Within 5°C of Actual Peak Temperature (t_P)	20 sec to 30 sec	20 sec to 30 sec
Ramp-Down Rate	3°C/sec max	3°C/sec max
Time 25°C ($t_{25^\circ\text{C}}$) to Peak Temperature	5 minute max	5 minute max

PIN CONFIGURATION AND FUNCTION DESCRIPTIONS



TOP VIEW
(TERMINAL SIDE DOWN)
Not to Scale

Figure 3. Pin Configuration

09027-903

Table 4. Pin Function Descriptions

Pin No.	Mnemonic	Description
1	OUTPUT	Analog Output Signal.
2	GND	Ground.
3	V _{DD}	Power Supply.

TYPICAL PERFORMANCE CHARACTERISTICS

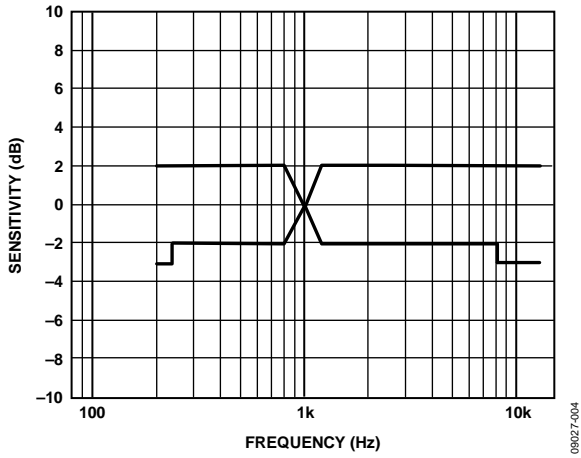

Figure 4. Frequency Response Mask

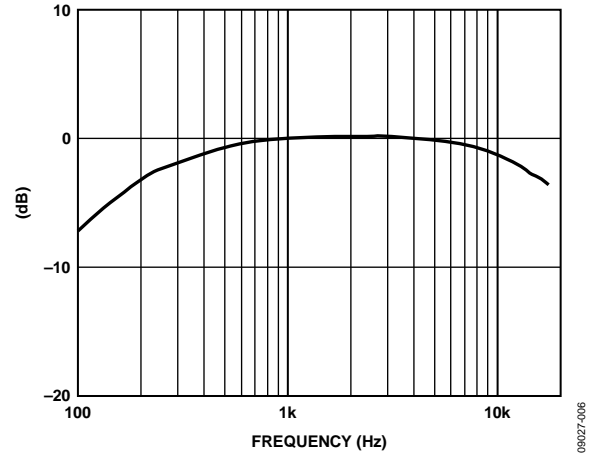

Figure 6. Typical Frequency Response (Measured)

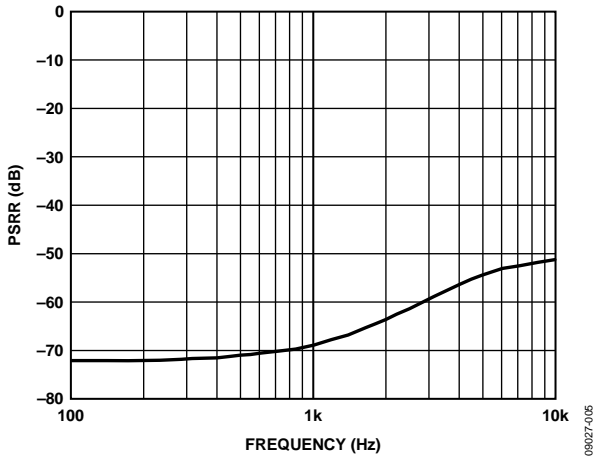

Figure 5. Typical Power Supply Rejection Ratio vs. Frequency

APPLICATIONS INFORMATION

CONNECTING TO ANALOG DEVICES, INC., AUDIO CODECS

The ADMP405 output can be connected to a dedicated codec microphone input (see Figure 7) or to a high input impedance gain stage (see Figure 8). A 0.1 μF ceramic capacitor placed close to the ADMP405 supply pin is used for testing and is recommended to adequately decouple the microphone from noise on the power supply. A dc-blocking capacitor is required at the output of the microphone.

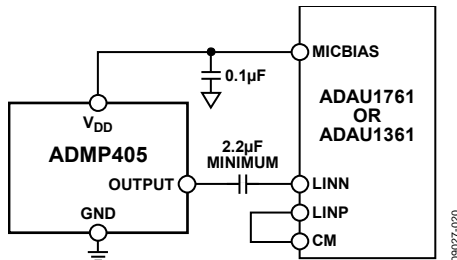

Figure 7. ADMP405 Connected to the Analog Devices ADAU1761 or ADAU1361 Codec

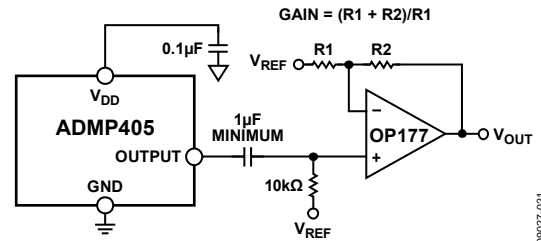

Figure 8. ADMP405 Connected to the OP177 Op Amp

SUPPORTING DOCUMENTS

Evaluation Board User Guide

[UG-143](#), EVAL-ADMP405Z-FLEX: Bottom-Ported Analog Output MEMS Microphone Evaluation Board

Application Notes

[AN-1003](#), Recommendations for Mounting and Connecting Analog Devices, Inc., Bottom-Ported MEMS Microphones

[AN-1068](#), Reflow Soldering of the MEMS Microphone

[AN-1112](#), Microphone Specifications Explained

[AN-1124](#), Recommendations for Sealing Analog Devices, Inc., Bottom-Port MEMS Microphones from Dust and Liquid Ingress

PCB LAND PATTERN LAYOUT

The recommended PCB land pattern for the ADMP405 should be laid out to a 1:1 ratio to the solder pads on the microphone package, as shown in Figure 9. Care should be taken to avoid applying solder paste to the sound hole in the PCB. A suggested

solder paste stencil pattern layout is shown in Figure 10. The diameter of the sound hole in the PCB should be larger than the diameter of the sound port of the microphone. A minimum diameter of 0.5 mm is recommended.

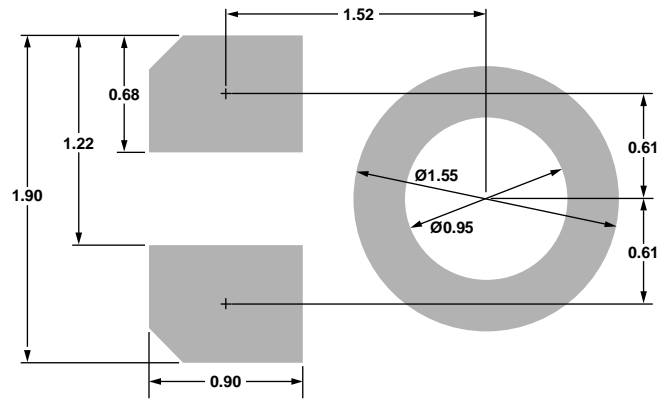

Figure 9. PCB Land Pattern Layout

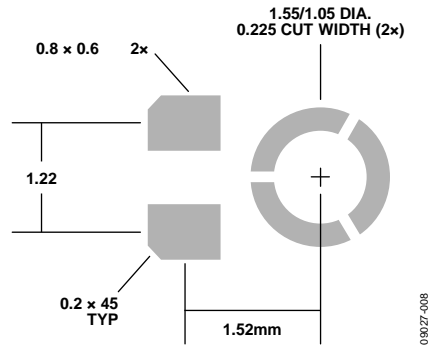

Figure 10. Suggested Solder Paste Stencil Pattern Layout

HANDLING INSTRUCTIONS

PICK-AND-PLACE EQUIPMENT

The MEMS microphone can be handled using standard pick-and-place and chip shooting equipment. Care should be taken to avoid damage to the MEMS microphone structure as follows:

- Use a standard pickup tool to handle the microphone. Because the microphone hole is on the bottom of the package, the pickup tool can make contact with any part of the lid surface.
- Use care during pick-and-place to ensure that no high shock events above 10 kg are experienced because such events may cause damage to the microphone.
- Do not pick up the microphone with a vacuum tool that makes contact with the bottom side of the microphone. Do not pull air out of or blow air into the microphone port.
- Do not use excessive force to place the microphone on the PCB.

REFLOW SOLDER

For best results, the soldering profile should be in accordance with the recommendations of the manufacturer of the solder paste used to attach the MEMS microphone to the PCB. It is recommended that the solder reflow profile not exceed the limit conditions specified in Figure 2 and Table 3.

BOARD WASH

When washing the PCB, ensure that water does not make contact with the microphone port. Blow-off procedures and ultrasonic cleaning must not be used.

RELIABILITY SPECIFICATIONS

The microphone sensitivity after stress must deviate by no more than ± 3 dB from the initial value.

Table 5.

Stress Test	Description
Low Temperature Operating Life	-40°C, 500 hours, powered
High Temperature Operating Life	+125°C, 500 hours, powered
Temperature Humidity Bias (THB)	+65°C/85% relative humidity (RH), 500 hours, powered
Temperature Cycle	-40°C/+125°C, one cycle per hour, 100 cycles
High Temperature Storage	+150°C, 500 hours
Low Temperature Storage	-40°C, 500 hours
Component Charge Device Model (CDM) ESD	All pins, 0.5 kV
Component Human Body Model (HBM) ESD	All pins, 1.5 kV
Component Machine Model (MM) ESD	All pins, 0.2 kV

OUTLINE DIMENSIONS

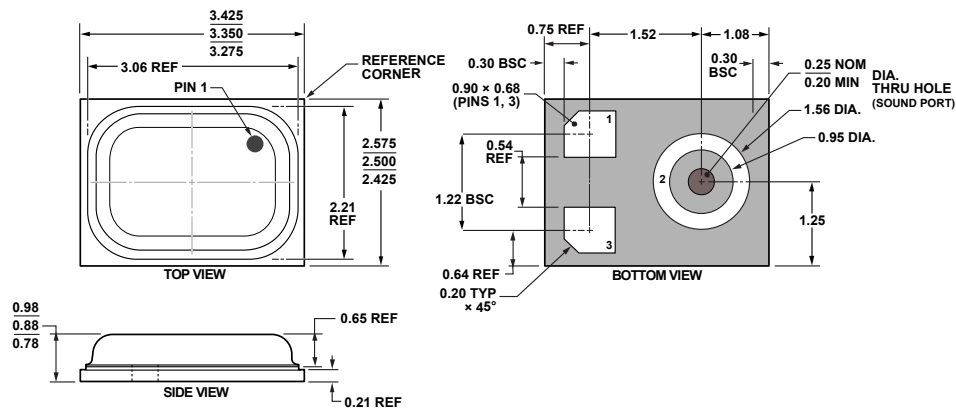
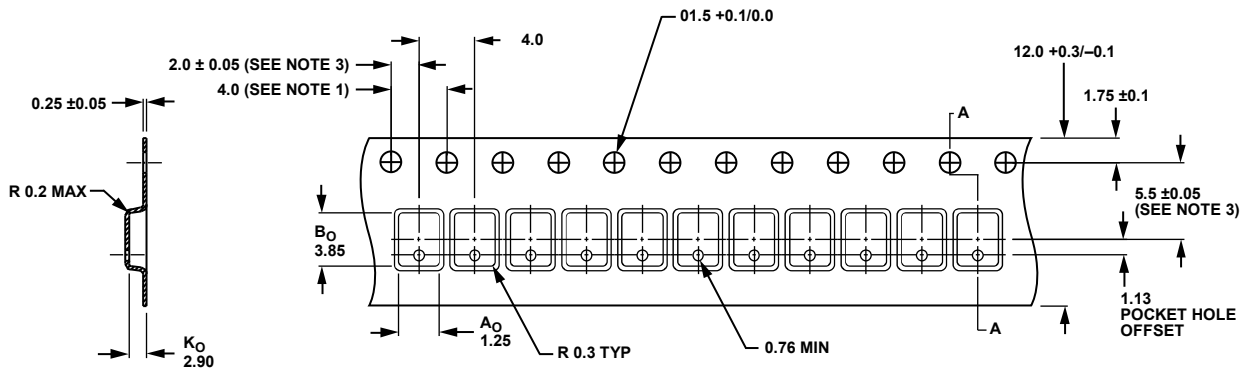

Figure 11. 3-Terminal Chip Array Small Outline No Lead Cavity [LGA_CAV]
3.35 mm x 2.50 mm Body
(CE-3-2)
Dimensions shown in millimeters



- NOTES
1. 10 SPROCKET HOLE PITCH CUMULATIVE TOLERANCE ± 0.2 .
 2. CAMBER IN COMPLIANCE WITH EIA 481.
 3. POCKET POSITION RELATIVE TO SPROCKET HOLE MEASURED AS TRUE POSITION OF POCKET, NOT POCKET HOLE.
 4. A_O AND B_O ARE CALCULATED ON A PLANE AT A DISTANCE "R" ABOVE THE BOTTOM OF THE POCKET.

Figure 12. LGA_CAV Tape and Reel Outline Dimensions
Dimensions shown in millimeters

ORDERING GUIDE

Model ¹	Temperature Range	Package Description	Package Option ²	Ordering Quantity
ADMP405ACEZ-RL	-40°C to +70°C	3-Terminal LGA_CAV, 13" Tape and Reel	CE-3-2	10,000
ADMP405ACEZ-RL7	-40°C to +70°C	3-Terminal LGA_CAV, 7" Tape and Reel	CE-3-2	1,000
EVAL-ADMP405Z-FLEX		Evaluation Board		

¹ Z = RoHS Compliant Part.
² This package option is halide free.

NOTES