

# SKM 145GB128DN



**SEMITRANS™ 2N**

## SPT IGBT Module

**SKM 145GB128DN**

**SKM 145GAL128DN**

Preliminary Data

### Features

- Homogeneous Si
- SPT = Soft-Punch-Through technology
- $V_{CEsat}$  with positive temperature coefficient
- High short circuit capability, self limiting to  $6 \times I_C$

### Typical Applications

- AC inverter drives
- UPS
- Electronic welders at  $f_{sw}$  up to 20kHz

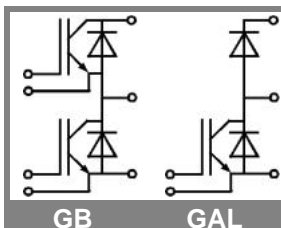

GB

GAL

Absolute Maximum Ratings		$T_c = 25^\circ\text{C}$ , unless otherwise specified	
Symbol	Conditions	Values	Units
<b>IGBT</b>			
$V_{CES}$		1200	V
$I_C$	$T_c = 25 (80)^\circ\text{C}$	190 (135)	A
$I_{CRM}$	$T_c = 25 (80)^\circ\text{C}$ , $t_p = 1 \text{ ms}$	380 (270)	A
$V_{GES}$		$\pm 20$	V
$T_{vj}$ ( $T_{stg}$ )	$T_{OPERATION} \leq T_{stg}$	-40 ... +150 (125)	$^\circ\text{C}$
$V_{isol}$	AC, 1 min.	4000	V
<b>Inverse diode</b>			
$I_F = -I_C$	$T_c = 25 (80)^\circ\text{C}$	130 (90)	A
$I_{FRM}$	$T_c = 25 (80)^\circ\text{C}$ , $t_p = 1 \text{ ms}$	380 (270)	A
$I_{FSM}$	$t_p = 10 \text{ ms}$ ; sin.; $T_j = 150^\circ\text{C}$	1100	A
<b>Freewheeling diode</b>			
$I_F = -I_C$	$T_c = 25 (80)^\circ\text{C}$	130 (90)	A
$I_{FRM}$	$T_c = 25 (80)^\circ\text{C}$ , $t_p = 1 \text{ ms}$	350 (260)	A
$I_{FSM}$	$t_p = 10 \text{ ms}$ ; sin.; $T_j = 150^\circ\text{C}$	1100	A

Characteristics		$T_c = 25^\circ\text{C}$ , unless otherwise specified			
Symbol	Conditions	min.	typ.	max.	Units
<b>IGBT</b>					
$V_{GE(th)}$	$V_{GE} = V_{CE}$ , $I_C = 4 \text{ mA}$	4,5	5,5	6,5	V
$I_{CES}$	$V_{GE} = 0$ , $V_{CE} = V_{CES}$ , $T_j = 25 (125)^\circ\text{C}$		0,1	0,3	mA
$V_{CE(TO)}$	$T_j = 25 (125)^\circ\text{C}$		1 (0,9)	1,15 (1,05)	V
$r_{CE}$	$V_{GE} = 15 \text{ V}$ , $T_j = 25 (125)^\circ\text{C}$		9 (12)	12 (15)	m $\Omega$
$V_{CE(sat)}$	$I_C = 100 \text{ A}$ , $V_{GE} = 15 \text{ V}$ , chip level		1,9 (2,1)	2,35 (2,55)	V
$C_{res}$	under following conditions		9		nF
$C_{oes}$	$V_{GE} = 0$ , $V_{CE} = 25 \text{ V}$ , $f = 1 \text{ MHz}$		1		nF
$C_{res}$			1		nF
$L_{CE}$				25	nH
$R_{CC'+EE'}$	res., terminal-chip $T_c = 25 (125)^\circ\text{C}$		0,75 (1)		m $\Omega$
$t_{d(on)}$	$V_{CC} = 600 \text{ V}$ , $I_C = 100 \text{ A}$		190		ns
$t_r$	$R_{Gon} = R_{Goff} = 9 \Omega$ , $T_j = 125^\circ\text{C}$		50		ns
$t_{d(off)}$	$V_{GE} = \pm 15 \text{ V}$		590		ns
$t_f$			50		ns
$E_{on} (E_{off})$			11,5 (9,5)		mJ
<b>Inverse diode</b>					
$V_F = V_{EC}$	$I_F = 100 \text{ A}$ ; $V_{GE} = 0 \text{ V}$ ; $T_j = 25 (125)^\circ\text{C}$		2 (1,8)	2,5	V
$V_{(TO)}$	$T_j = 25 (125)^\circ\text{C}$		1,1	1,4	V
$r_T$	$T_j = 25 (125)^\circ\text{C}$		9	13	m $\Omega$
$I_{RRM}$	$I_F = 100 \text{ A}$ ; $T_j = 125 ( )^\circ\text{C}$		130		A
$Q_{rr}$	$di/dt = 3500 \text{ A}/\mu\text{s}$		14		$\mu\text{C}$
$E_{rr}$	$V_{GE} = 0 \text{ V}$		4,8		mJ
<b>FWD</b>					
$V_F = V_{EC}$	$I_F = 100 \text{ A}$ ; $V_{GE} = 0 \text{ V}$ ; $T_j = 25 (125)^\circ\text{C}$		2,1 (1,8)	2,5	V
$V_{(TO)}$	$T_j = 25 (125)^\circ\text{C}$		1,1	1,4	V
$r_T$	$T_j = 25 (125)^\circ\text{C}$		9	13	m $\Omega$
$I_{RRM}$	$I_F = 100 \text{ A}$ ; $T_j = 25 (125)^\circ\text{C}$		130		A
$Q_{rr}$	$di/dt = 0 \text{ A}/\mu\text{s}$		14		$\mu\text{C}$
$E_{rr}$	$V_{GE} = 0 \text{ V}$		4,8		mJ
<b>Thermal characteristics</b>					
$R_{th(j-c)}$	per IGBT			0,165	K/W
$R_{th(j-c)D}$	per Inverse Diode			0,36	K/W
$R_{th(c-s)}$	per module			0,05	K/W
<b>Mechanical data</b>					
$M_s$	to heatsink M6	3		5	Nm
$M_t$	to terminals M5	2,5		5	Nm
w				160	g

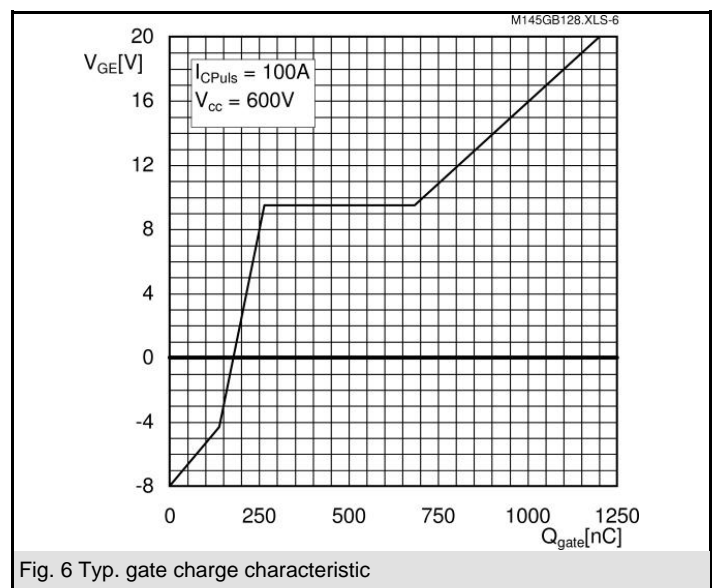
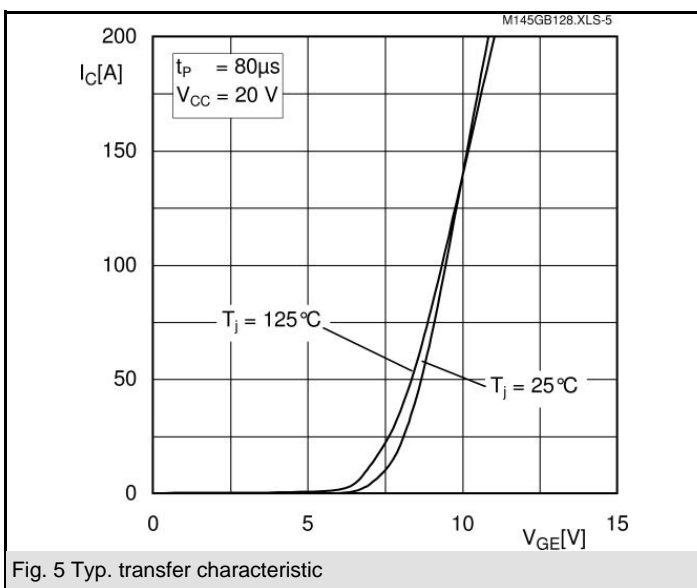
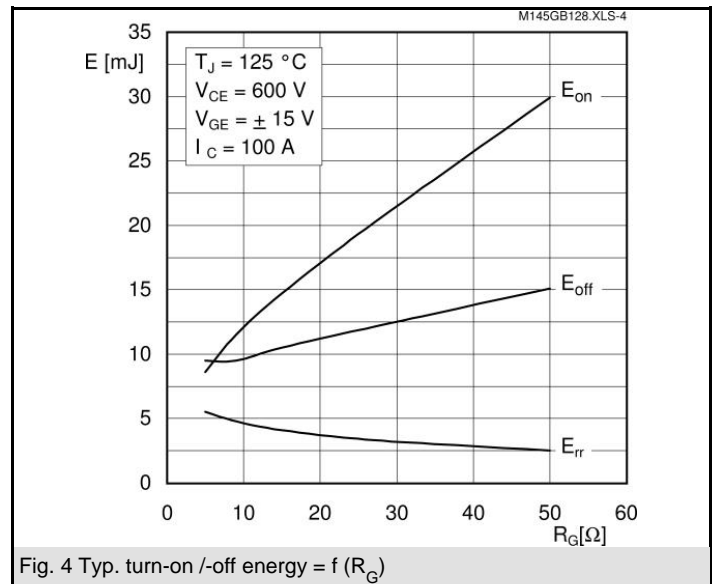
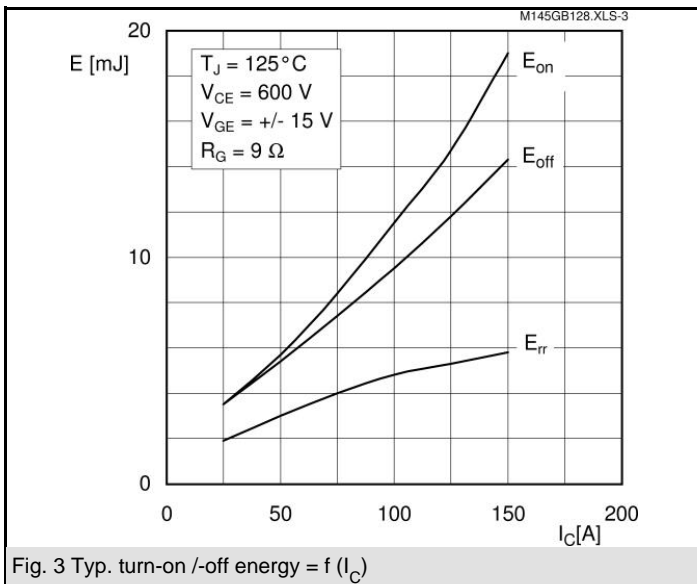
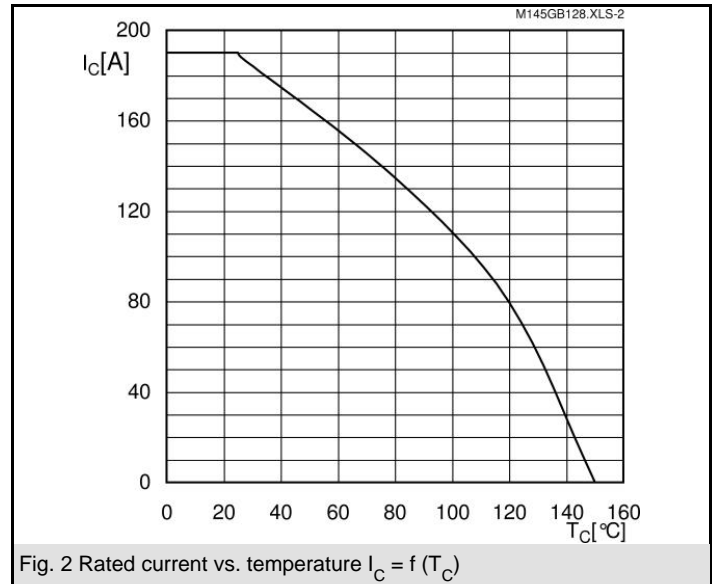
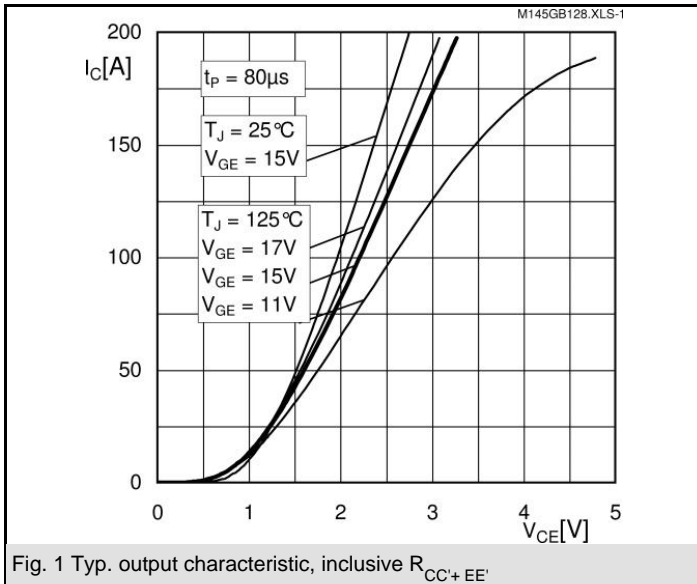

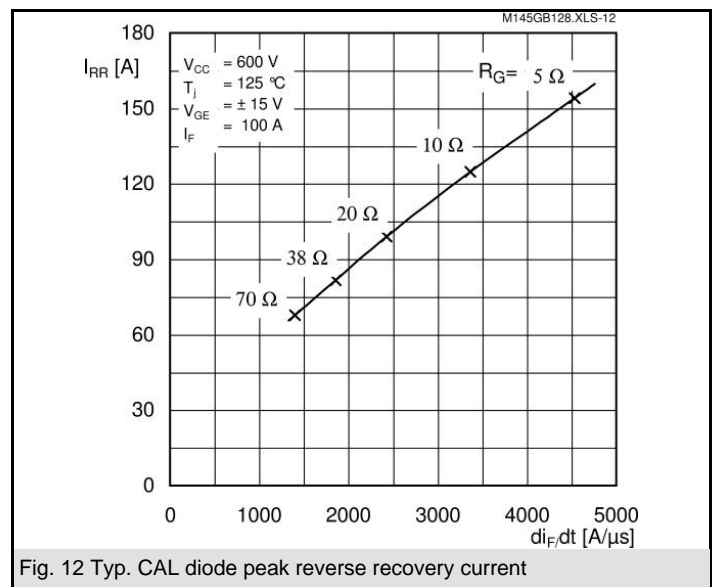
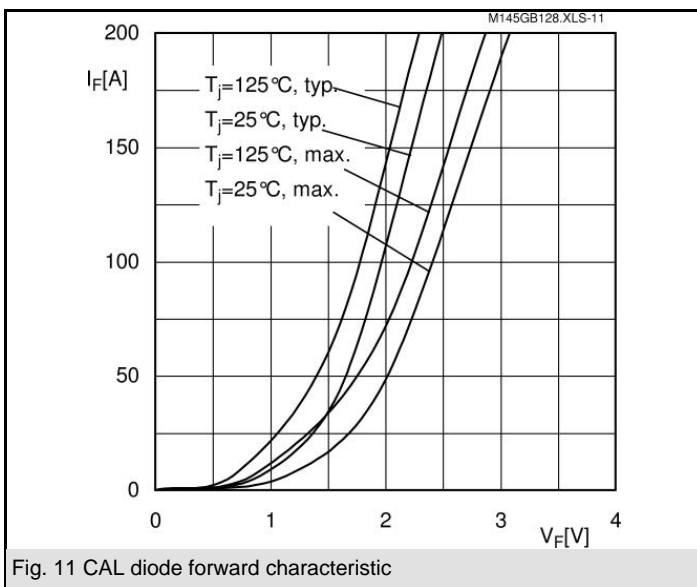
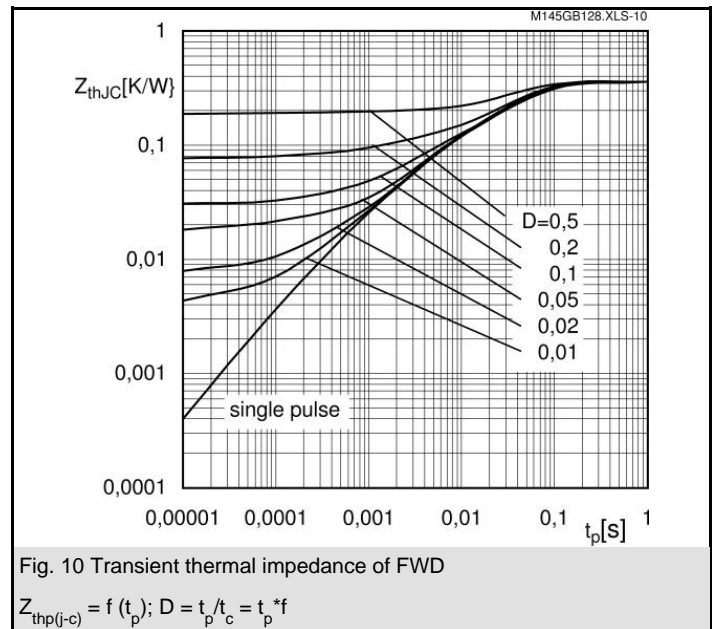
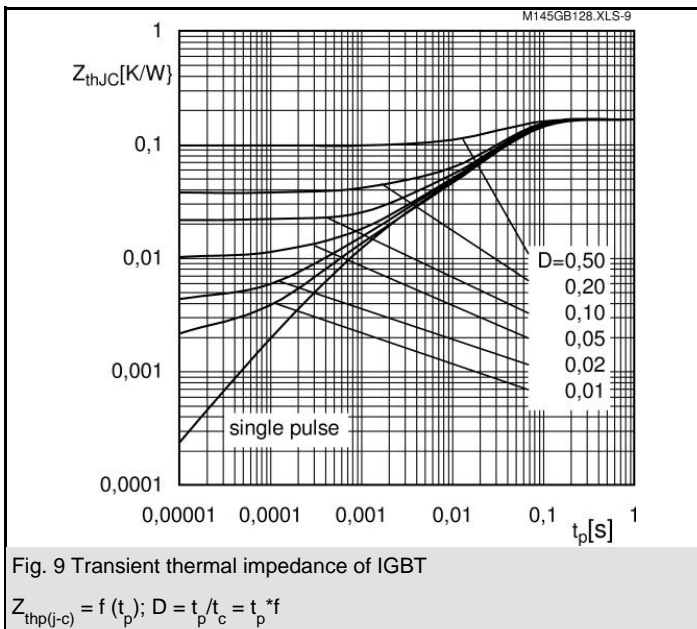
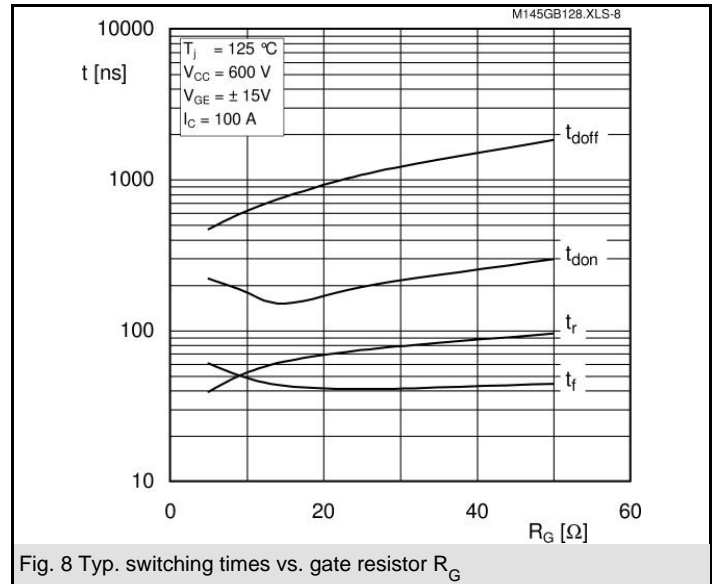
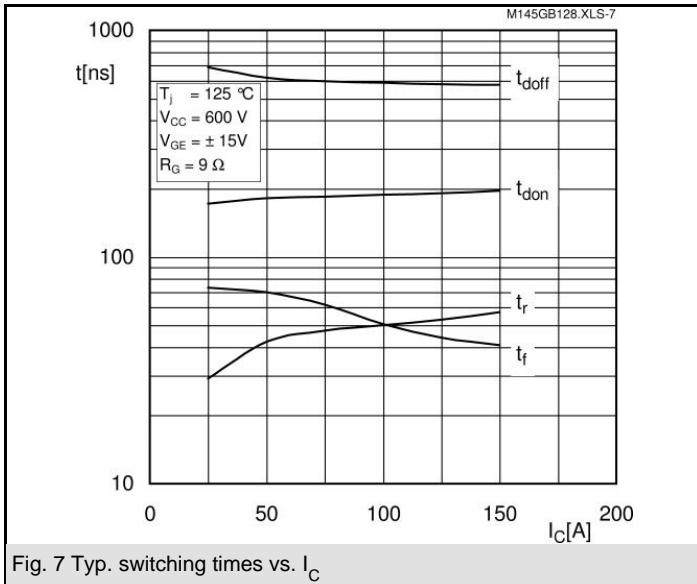

# SKM 145GB128DN

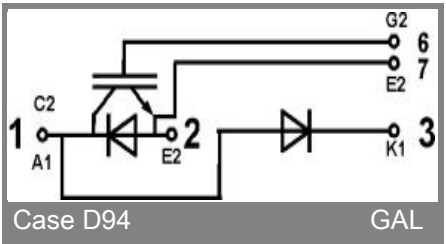
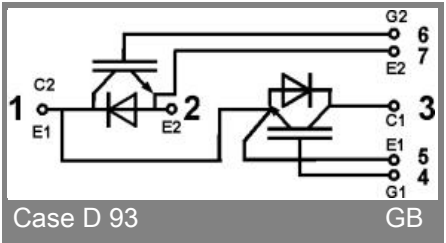
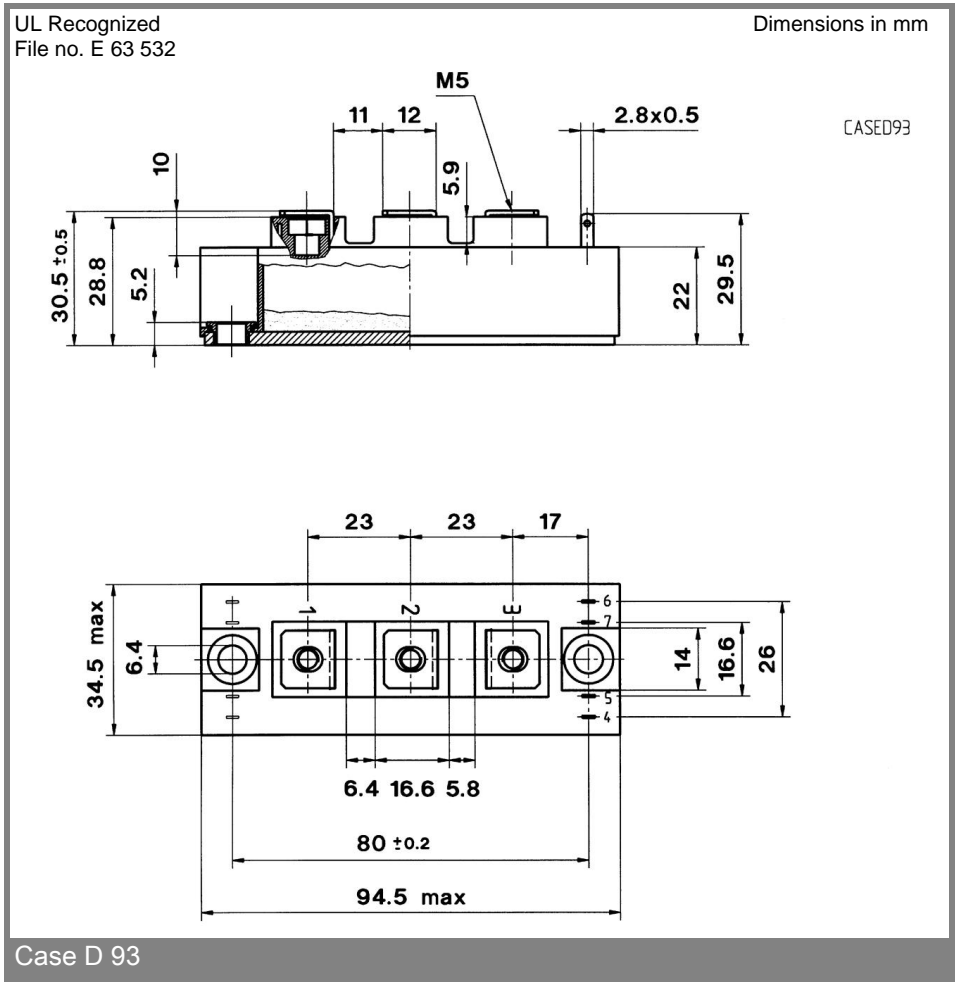
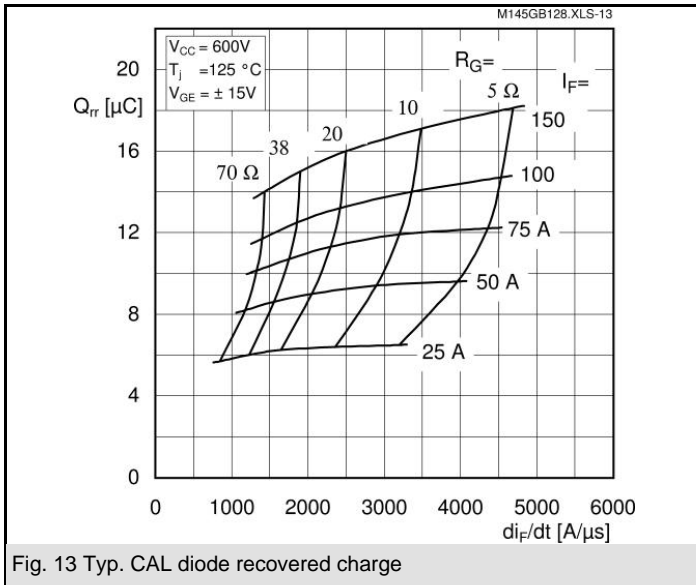

This is an electrostatic discharge sensitive device (ESDS), international standard IEC 60747-1, Chapter IX.

This technical information specifies semiconductor devices but promises no characteristics. No warranty or guarantee expressed or implied is made regarding delivery, performance or suitability.