

## Steel, Aluminum, and Nonmetallic Plugmold Raceway and Multioutlet Assemblies



The selection of steel, aluminum, and nonmetallic provides a versatile solution for many applications. Plugmold sections offer single or alternating circuits, standard or isolated ground receptacles, and Snapicoil® harnesses of prewired receptacles or cord ended units.

Steel Plugmold comes in an ivory ScuffCoat™ or gray enamel finish. The ScuffCoat finish is scratch resistant and protects against nicks and chips while preventing color from fading.

Aluminum Plugmold offers an attractive choice for hospital and commercial labs. The finish offers high-tech aesthetics and corrosion resistance.

Nonmetallic Plugmold has a textured ivory finish with duplex receptacles. This series offers a field serviceable surge module that protects the entire Plugmold strip and makes on-site changes easy.

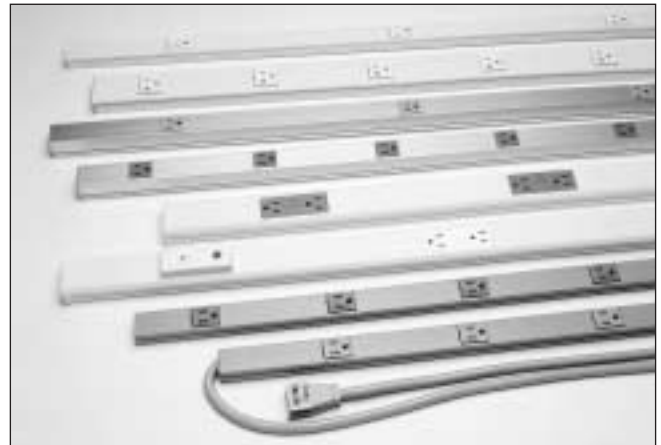

Plugmold Systems come in a variety of finishes and configurations.

### Features & Benefits



- **Steel, aluminum, or nonmetallic material.** Variety provides choice for the application.
- **Many finishes.** Ivory ScuffCoat finish or gray surface for steel, aluminum satin anodized, and ivory nonmetallic textured finish.
- **Compact, low profile appearance.** Requires minimal space.
- **Full range of fittings.** Provides a complete wiring solution.
- **Single, alternating circuit, and isolated ground receptacles available.** Meets virtually any job requirement.
- **Variety of lengths.** Ideal for different spaces.
- **Choose receptacle spacing.** Suits many applications.
- **Snapicoil harnesses with different lengths and receptacle spacing.** Offers a solution for many electrical requirements.
- **Duplex receptacle.** Aesthetically pleasing, functional 20A duplex for the 24S (2400) Series. **NEW!**
- **Single- and dual-gang boxes available.** Wire devices into the raceway system.
- **Field replaceable surge module.** Replaces the module, not a receptacle (NM2000 Series only).
- **Customization available.** All products can be modified to accommodate virtually any application.
- **2400 Backfeed.** Fitting helps installation over an existing wall box. **NEW!**
- **Datacom connectivity options.** Accepts industry standard and proprietary devices from a wide range of manufacturers to provide a seamless and aesthetically pleasing interface for voice, data, audio, and video applications at the point-of-use.
- **UL and cUL Listed.** Safety and reliability in the applications.
- **cUL Listed 24S (2400) Series Plugmold.** This 20A version is cUL Listed. **NEW!**

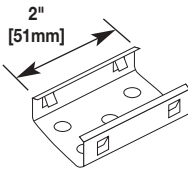
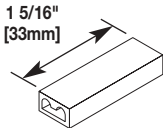
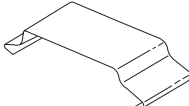
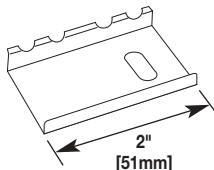
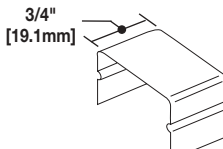
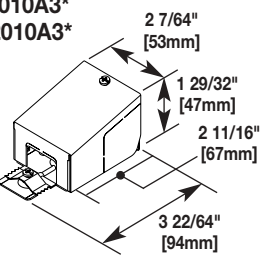
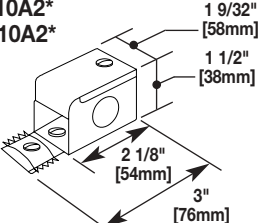

Plugmold Systems shown in typical applications.

# V/G 2000 Series

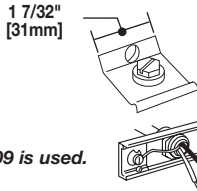
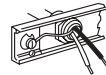
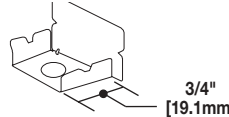
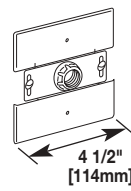
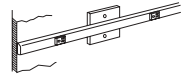
| Catalog No./Item   | Description/Specifications   |           |            |        |          |      |              |           |            |       |            |           |            |              |             |           |            |
|--|--|-----------|------------|--------|----------|------|--------------|-----------|------------|-------|------------|-----------|------------|--------------|-------------|-----------|------------|
| <b>Base and Cover</b>  |  |           |            |        |          |      |              |           |            |       |            |           |            |              |             |           |            |
|  | <table border="1" style="width: 100%; border-collapse: collapse;"> <thead> <tr> <th style="width: 15%;">ITEM</th> <th style="width: 15%;">CAT. NO.</th> <th style="width: 20%;">LENGTH</th> <th style="width: 50%;">MATERIAL</th> </tr> </thead> <tbody> <tr> <td>Base</td> <td>V/G 2000B-5*</td> <td>5' [1.5m]</td> <td>.040 Steel</td> </tr> <tr> <td>Cover</td> <td>V/G 2000C*</td> <td>5' [1.5m]</td> <td>.025 Steel</td> </tr> <tr> <td>Base &amp; Cover</td> <td>V/G 2000BC*</td> <td>5' [1.5m]</td> <td>.025 Steel</td> </tr> </tbody> </table> | ITEM      | CAT. NO.   | LENGTH | MATERIAL | Base | V/G 2000B-5* | 5' [1.5m] | .040 Steel | Cover | V/G 2000C* | 5' [1.5m] | .025 Steel | Base & Cover | V/G 2000BC* | 5' [1.5m] | .025 Steel |
| ITEM   | CAT. NO.   | LENGTH    | MATERIAL   |        |          |      |              |           |            |       |            |           |            |              |             |           |            |
| Base   | V/G 2000B-5*   | 5' [1.5m] | .040 Steel |        |          |      |              |           |            |       |            |           |            |              |             |           |            |
| Cover  | V/G 2000C*   | 5' [1.5m] | .025 Steel |        |          |      |              |           |            |       |            |           |            |              |             |           |            |
| Base & Cover   | V/G 2000BC*  | 5' [1.5m] | .025 Steel |        |          |      |              |           |            |       |            |           |            |              |             |           |            |
| <b>V2003</b><br><b>2003</b>           | <b>Supporting Clip</b> – For temporary support, while positioning lengths of raceway base. Use with V/G 2000 Series. V2003 has ivory finish, 2003 has plated finish.   |           |            |        |          |      |              |           |            |       |            |           |            |              |             |           |            |
| <b>W30</b>                            | <b>Pressure-Type Wire Connector</b> – For common connection of two, three, or four No. 12 or No.14 solid copper conductors. Not for connection of equipment grounding conductor. 300V maximum; 20A 60° C maximum. Not for use with aluminum conductors.  |           |            |        |          |      |              |           |            |       |            |           |            |              |             |           |            |
| <b>2000WC</b>                         | <b>Wire Clip</b> – Holds conductors in place in raceway.   |           |            |        |          |      |              |           |            |       |            |           |            |              |             |           |            |
| <b>2001</b>                         | <b>Coupling</b> – For joining lengths of 2000 Series Raceway Base.   |           |            |        |          |      |              |           |            |       |            |           |            |              |             |           |            |
| <b>V2006*</b><br><b>G2006*</b>      | <b>Cover Clip</b> – For covering joint where lengths of cover or base adjoin. Use with V/G 2000 Series.  |           |            |        |          |      |              |           |            |       |            |           |            |              |             |           |            |
| <b>V2010A3*</b><br><b>G2010A3*</b>  | <b>Entrance End</b> – Offers larger capacity than V2010A2. 1/2" trade size KOs on end, each side and bottom. 3/4" trade size KOs on bottom and rear. Includes ground screw. Use with V/G 2000 Series.  |           |            |        |          |      |              |           |            |       |            |           |            |              |             |           |            |
| <b>V2010A2*</b><br><b>G2010A2*</b>  | <b>Entrance End</b> – For connecting V2000 with 1/2" conduit and armored cable connectors. 1/2" trade size KOs on end, each side and bottom. Includes ground screw. Use with V/G 2000 Series.  |           |            |        |          |      |              |           |            |       |            |           |            |              |             |           |            |

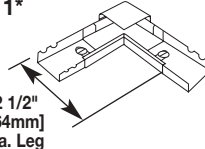
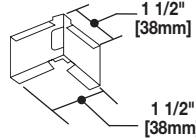
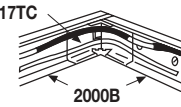
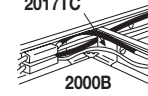
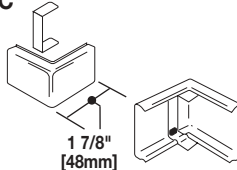
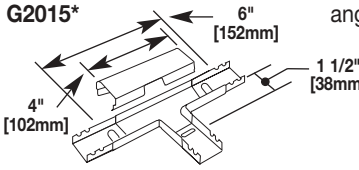
| Catalog No./Item  | Description/Specifications  |
|---|---|
| <b>2009</b>   | <b>Ground Clamp</b> – For connection of equipment grounding conductor to provide additional ground to raceway. Use with V/G2000 Series.                                       |
| <i>How 2009 is used.</i>   |   |
| <b>V2010B*</b><br><b>G2010B*</b>                                    | <b>Blank End Fitting</b> – For closing the open end of raceway. Use with V/G 2000 Series.   |
| <b>V2051</b>    | <b>Flush Plate Adapter</b> – For feeding 2000 from an existing wall outlet. Equipped with 1/2" [12.7mm] threaded stud, toothed lockwasher for grounding, and conduit bushing. |
|  <p><i>Plugmold 2000 extended from wall outlet using 2051H.</i></p> |  <p><i>2051H fastened to horizontally mounted wall box.</i></p>                            |
|   |  <p><i>2051H fastened to vertically mounted wall box.</i></p>                              |
| <b>V2011*</b><br><b>G2011*</b>                                     | <b>90° Flat Elbow</b> – For right angle turns on same surface. Cover stop permits neat butting of 2000C Cover. Two couplings furnished.                                       |
| <b>2017TC</b>   | <b>Internal Corner Coupling</b> – Furnished with one fiber bushing.   |
|   |  <p><i>2017TC used as a corner coupling.</i></p>   |
|   |  <p><i>2017TC used as a corner coupling and a straight-through fitting.</i></p>          |
| <b>V2018C*</b><br><b>G2018C*</b>                                  | <b>External Elbow</b> – To continue raceway runs around outside corner. Fills the gap when external corner is made by notching and bending the 2000 Base.                     |
|   | <i>Cover gap filler snapped into place in 2018C.</i>  |
| <b>V2015*</b><br><b>G2015*</b>                                    | <b>Tee</b> – For branches at right angles. Couplings furnished.   |

\* Use "V" prefix for Ivory finish and "G" prefix for Gray finish.

## V/G 2000 Series (continued)

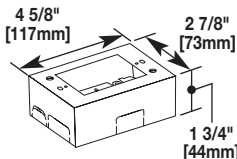
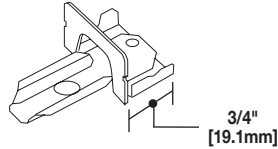
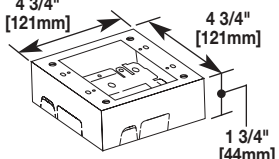
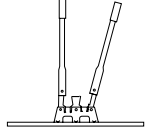
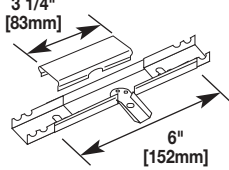
| Catalog No./Item   | Description/Specifications  | Catalog No./Item   | Description/Specifications  |
|--|---|--|---|
| <b>V2048</b><br><b>G2048</b>  | <b>Single Gang Device Box</b> – Cover has twistouts for 2000, V500, and V700 Raceway. Base has 1/2" trade KO and rectangular KO for extension to wall box. Base has #10 threaded hole for ground connection.      | <b>V2089E</b>  | <b>End Reducing Connector</b> – For connecting V2000 with V500 Raceway through end of V2000.  |
| <b>V2048-2</b>                | <b>Two-Gang Device Box</b> – Cover has G2048-2 Twistouts for 2000, V500, and V700 Raceway. Base has 1/2" trade KO and rectangular KO for extension to wall box. Base has #10 threaded hole for ground connection. | <b>620</b>     | <b>2000 Raceway Base and Cover Cutter</b> – Portable cutter for 2000 Cover and Base. Tool steel construction for clean and easy square cuts every time. Total manual operation. |
| <b>V2089</b>                  | <b>Side Reducing Connector</b> – For connecting V2000 with V500 Raceway through side of V2000.  | <b>620BCK</b>  | <b>Replacement Blade Kit</b> – Replacement blades and die set for 620 Cutter.   |

\* Use "V" prefix for Ivory finish and "G" prefix for Gray finish.

## V2400 Series

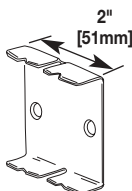
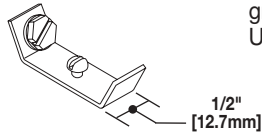
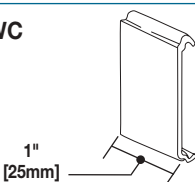
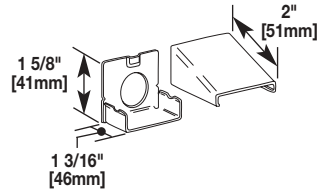
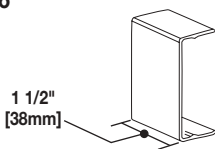
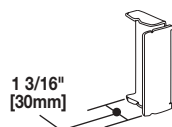
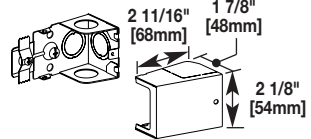
| Catalog No./Item  | Description/Specifications   | Catalog No./Item   | Description/Specifications  |      |         |        |          |      |        |           |            |       |        |           |            |              |         |           |            |
|---|--|--|---|------|---------|--------|----------|------|--------|-----------|------------|-------|--------|-----------|------------|--------------|---------|-----------|------------|
| <b>Base and Cover</b>   |  |  |   |      |         |        |          |      |        |           |            |       |        |           |            |              |         |           |            |
| <table border="1" style="width: 100%; border-collapse: collapse;"> <thead> <tr> <th>ITEM</th> <th>CAT NO.</th> <th>LENGTH</th> <th>MATERIAL</th> </tr> </thead> <tbody> <tr> <td>Base</td> <td>V2400B</td> <td>5' [1.5m]</td> <td>.040 Steel</td> </tr> <tr> <td>Cover</td> <td>V2400C</td> <td>5' [1.5m]</td> <td>.040 Steel</td> </tr> <tr> <td>Base &amp; Cover</td> <td>V2400BC</td> <td>5' [1.5m]</td> <td>.040 Steel</td> </tr> </tbody> </table> |  |  |   | ITEM | CAT NO. | LENGTH | MATERIAL | Base | V2400B | 5' [1.5m] | .040 Steel | Cover | V2400C | 5' [1.5m] | .040 Steel | Base & Cover | V2400BC | 5' [1.5m] | .040 Steel |
| ITEM  | CAT NO.  | LENGTH   | MATERIAL  |      |         |        |          |      |        |           |            |       |        |           |            |              |         |           |            |
| Base  | V2400B   | 5' [1.5m]  | .040 Steel  |      |         |        |          |      |        |           |            |       |        |           |            |              |         |           |            |
| Cover   | V2400C   | 5' [1.5m]  | .040 Steel  |      |         |        |          |      |        |           |            |       |        |           |            |              |         |           |            |
| Base & Cover  | V2400BC  | 5' [1.5m]  | .040 Steel  |      |         |        |          |      |        |           |            |       |        |           |            |              |         |           |            |
| <b>2401</b>    | <b>Coupling</b> – For joining lengths of raceway. Use with V2400 Series.   | <b>2409</b>    | <b>Ground Clamp</b> – No. 10 ground screw provided. Use with V2400 Series.  |      |         |        |          |      |        |           |            |       |        |           |            |              |         |           |            |
| <b>2400WC</b>    | <b>Wire Clip</b> – Holds conductors in place in raceway.   | <b>V2410A</b>  | <b>Entrance End</b> – For connecting V2400 with 1/2" trade size conduit and armored cable. Use with V2400 Series.         |      |         |        |          |      |        |           |            |       |        |           |            |              |         |           |            |
| <b>V2406</b>   | <b>Cover Clip</b> – For covering joint where lengths of cover or base adjoin. Use with V2400 Series (nonmetallic). | <b>V2410B</b>  | <b>Blank End</b> – For closing open end of V2400 Series.  |      |         |        |          |      |        |           |            |       |        |           |            |              |         |           |            |
|   |  | <b>V2410C</b>  | <b>Entrance End Fitting</b> – Has 1/2" and 3/4" trade size KOs on end and bottom. Additional 1/2" trade size KO on sides. |      |         |        |          |      |        |           |            |       |        |           |            |              |         |           |            |

## V2400 Series (continued)

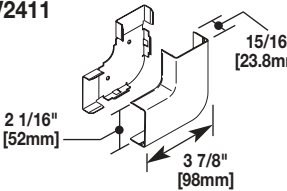
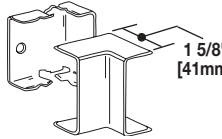
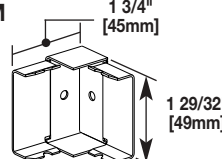
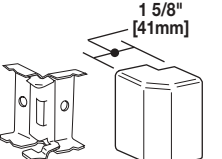
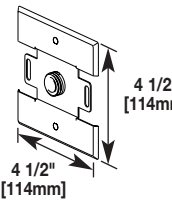
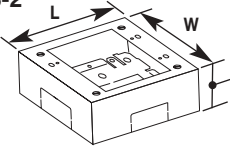
| Catalog No./Item  | Description/Specifications   |
|---|--|
| <b>V2411</b><br>                     | <b>90° Flat Elbow</b> – For right angle turns on the same surface (nonmetallic cover).<br>Dimensions: 15/16" [23.8mm] height, 2 1/16" [52mm] width, 3 7/8" [98mm] length.  |
| <b>V2417</b><br>                     | <b>Internal Elbow</b> – For making internal corners (nonmetallic cover).<br>Dimension: 1 5/8" [41mm] height.   |
| <b>V2417M</b><br>                    | <b>Internal Elbow</b> – For making internal 90° corners. All steel construction.<br>Dimensions: 1 3/4" [45mm] height, 1 29/32" [49mm] width.   |
| <b>V2418</b><br>                     | <b>External Elbow</b> – For covering outside corners (nonmetallic cover).<br>Dimension: 1 5/8" [41mm] height.  |
| <b>V2451H</b><br>                   | <b>Back Feed Fitting</b> – For feeding V2400 Raceway from an existing outlet box. Equipped with 1/2" trade size male bushing and locknut washer for grounding.<br>Dimensions: 4 1/2" [114mm] height, 4 1/2" [114mm] width. |
| <b>V2448</b><br><b>V2448-2</b><br> | <b>Device Box</b> – Cover has one twistout for 2400 on each side and ends. Base has 1/2" trade KO and rectangular KO for extension to wall box. Base has #10 threaded hole for ground connection.                          |

| CAT NO. | L              | W              | D             | GANG # |
|---------|----------------|----------------|---------------|--------|
| V2448   | 4 5/8" [117mm] | 2 7/8" [73mm]  | 1 3/4" [44mm] | 1      |
| V2448-2 | 4 3/4" [121mm] | 4 3/4" [121mm] | 1 3/4" [44mm] | 2      |

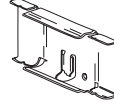
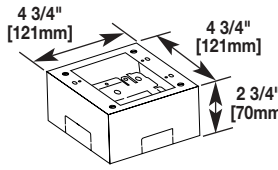
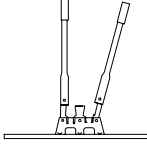
| Catalog No./Item   | Description/Specifications  |                |               |        |   |        |       |                |               |               |   |         |                |                |               |   |
|--|---|----------------|---------------|--------|---|--------|-------|----------------|---------------|---------------|---|---------|----------------|----------------|---------------|---|
| <b>V2489</b><br>                   | <b>Side Reducing Connector</b> – For connecting V2400 with V500 Raceway.  |                |               |        |   |        |       |                |               |               |   |         |                |                |               |   |
| <b>V2444</b><br><b>V2444-2</b><br> | <b>Extra Deep Device Box</b> – Base has rectangular knockout to enable extension from existing single-gang flush wall box and 1/2" and 1" concentric KOs. V2444 Cover has two twistouts for 500 and 700, and two twistouts for 2400. V2444-2 Cover has four 2400 Series twistouts.  |                |               |        |   |        |       |                |               |               |   |         |                |                |               |   |
|  | <table border="1" style="width: 100%; border-collapse: collapse;"> <thead> <tr> <th>CAT NO.</th> <th>L</th> <th>W</th> <th>D</th> <th>GANG #</th> </tr> </thead> <tbody> <tr> <td>V2444</td> <td>4 5/8" [117mm]</td> <td>2 7/8" [73mm]</td> <td>1 3/4" [44mm]</td> <td>1</td> </tr> <tr> <td>V2444-2</td> <td>4 3/4" [121mm]</td> <td>4 3/4" [121mm]</td> <td>1 3/4" [44mm]</td> <td>2</td> </tr> </tbody> </table> | CAT NO.        | L             | W      | D | GANG # | V2444 | 4 5/8" [117mm] | 2 7/8" [73mm] | 1 3/4" [44mm] | 1 | V2444-2 | 4 3/4" [121mm] | 4 3/4" [121mm] | 1 3/4" [44mm] | 2 |
| CAT NO.  | L   | W              | D             | GANG # |   |        |       |                |               |               |   |         |                |                |               |   |
| V2444  | 4 5/8" [117mm]  | 2 7/8" [73mm]  | 1 3/4" [44mm] | 1      |   |        |       |                |               |               |   |         |                |                |               |   |
| V2444-2  | 4 3/4" [121mm]  | 4 3/4" [121mm] | 1 3/4" [44mm] | 2      |   |        |       |                |               |               |   |         |                |                |               |   |
| <b>624</b><br>                     | <b>2400 and 2400BD Raceway &amp; Cover Cutter</b> – Portable cutter for 2400B and 2400BD Raceway and Cover. Tool steel construction for clean and easy square cuts. Total manual operation.   |                |               |        |   |        |       |                |               |               |   |         |                |                |               |   |
| <b>624BCK</b>  | <b>Replacement Blade Kit</b> – Replacement blades and die set for 624 Cutter.   |                |               |        |   |        |       |                |               |               |   |         |                |                |               |   |

## AL Series

| Catalog No./Item      | Description/Specifications  |           |               |        |          |      |           |           |               |       |           |           |               |      |            |           |               |      |           |           |               |       |         |           |               |      |            |           |               |
|-----------------------|---|-----------|---------------|--------|----------|------|-----------|-----------|---------------|-------|-----------|-----------|---------------|------|------------|-----------|---------------|------|-----------|-----------|---------------|-------|---------|-----------|---------------|------|------------|-----------|---------------|
| <b>Base and Cover</b> |   |           |               |        |          |      |           |           |               |       |           |           |               |      |            |           |               |      |           |           |               |       |         |           |               |      |            |           |               |
|                       | <table border="1" style="width: 100%; border-collapse: collapse;"> <thead> <tr> <th>ITEM</th> <th>CAT NO.</th> <th>LENGTH</th> <th>MATERIAL</th> </tr> </thead> <tbody> <tr> <td>Base</td> <td>AL2000B-5</td> <td>5' [1.5m]</td> <td>.060 Aluminum</td> </tr> <tr> <td>Cover</td> <td>AL2000C-5</td> <td>5' [1.5m]</td> <td>.060 Aluminum</td> </tr> <tr> <td>Base</td> <td>AL2000B-10</td> <td>10' [3.m]</td> <td>.060 Aluminum</td> </tr> <tr> <td>Base</td> <td>AL2400B-5</td> <td>5' [1.5m]</td> <td>.060 Aluminum</td> </tr> <tr> <td>Cover</td> <td>AL2400C</td> <td>5' [1.5m]</td> <td>.060 Aluminum</td> </tr> <tr> <td>Base</td> <td>AL2400B-10</td> <td>10' [3.m]</td> <td>.060 Aluminum</td> </tr> </tbody> </table> | ITEM      | CAT NO.       | LENGTH | MATERIAL | Base | AL2000B-5 | 5' [1.5m] | .060 Aluminum | Cover | AL2000C-5 | 5' [1.5m] | .060 Aluminum | Base | AL2000B-10 | 10' [3.m] | .060 Aluminum | Base | AL2400B-5 | 5' [1.5m] | .060 Aluminum | Cover | AL2400C | 5' [1.5m] | .060 Aluminum | Base | AL2400B-10 | 10' [3.m] | .060 Aluminum |
| ITEM                  | CAT NO.   | LENGTH    | MATERIAL      |        |          |      |           |           |               |       |           |           |               |      |            |           |               |      |           |           |               |       |         |           |               |      |            |           |               |
| Base                  | AL2000B-5   | 5' [1.5m] | .060 Aluminum |        |          |      |           |           |               |       |           |           |               |      |            |           |               |      |           |           |               |       |         |           |               |      |            |           |               |
| Cover                 | AL2000C-5   | 5' [1.5m] | .060 Aluminum |        |          |      |           |           |               |       |           |           |               |      |            |           |               |      |           |           |               |       |         |           |               |      |            |           |               |
| Base                  | AL2000B-10  | 10' [3.m] | .060 Aluminum |        |          |      |           |           |               |       |           |           |               |      |            |           |               |      |           |           |               |       |         |           |               |      |            |           |               |
| Base                  | AL2400B-5   | 5' [1.5m] | .060 Aluminum |        |          |      |           |           |               |       |           |           |               |      |            |           |               |      |           |           |               |       |         |           |               |      |            |           |               |
| Cover                 | AL2400C   | 5' [1.5m] | .060 Aluminum |        |          |      |           |           |               |       |           |           |               |      |            |           |               |      |           |           |               |       |         |           |               |      |            |           |               |
| Base                  | AL2400B-10  | 10' [3.m] | .060 Aluminum |        |          |      |           |           |               |       |           |           |               |      |            |           |               |      |           |           |               |       |         |           |               |      |            |           |               |

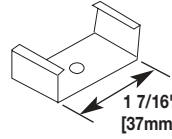
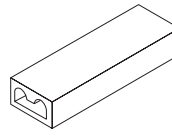
| Catalog No./Item  | Description/Specifications  |
|---|---|
| <b>AL2003</b><br> | <b>Supporting Clip</b> – Mount to surface with No. 8 flathead screws. Use with AL2000 Series.<br>Dimension: 1 7/16" [37mm] width.   |
| <b>W30</b><br>    | <b>Pressure-Type Wire Connector</b> – For common connection of two, three, or four No. 12 or No.14 solid copper conductors. Not for connection of equipment grounding conductor. 300V maximum; 20A 60° C maximum. Not for use with aluminum conductors. |

## AL Series (Continued)

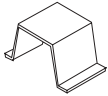
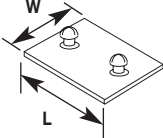
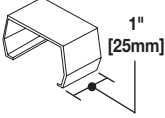
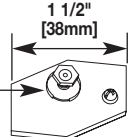
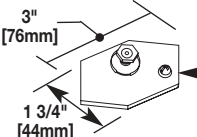
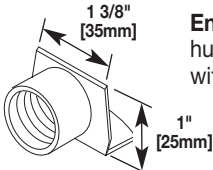
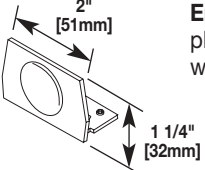
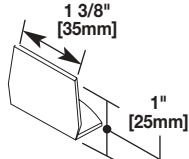
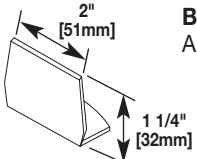
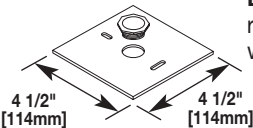
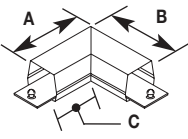
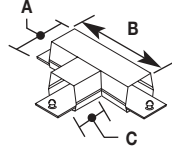
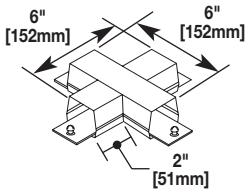
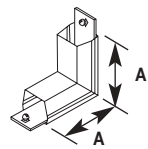
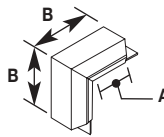
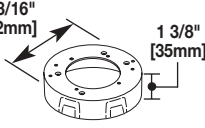
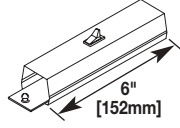
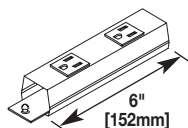
| Catalog No./Item     | Description/Specification   |               |                |        |           |               |                |            |                |               |            |            |           |
|----------------------|---|---------------|----------------|--------|-----------|---------------|----------------|------------|----------------|---------------|------------|------------|-----------|
| AL2000WC<br>AL2400WC |  <p><b>Wire Clip</b> – Holds conductors in place in raceway (nonmetallic).</p>   |               |                |        |           |               |                |            |                |               |            |            |           |
| AL2001<br>AL2401     |  <p><b>Coupling</b> – For joining lengths of raceway. Use with AL2000 and AL2400 Series.</p> <table border="1" style="margin-left: auto; margin-right: auto;"> <thead> <tr> <th>CAT NO.</th> <th>L</th> <th>W</th> </tr> </thead> <tbody> <tr> <td>AL2001</td> <td>1 5/8" [41mm]</td> <td>1 1/2" [38mm]</td> </tr> <tr> <td>AL2401</td> <td>3" [76mm]</td> <td>1 3/4" [44mm]</td> </tr> </tbody> </table>  | CAT NO.       | L              | W      | AL2001    | 1 5/8" [41mm] | 1 1/2" [38mm]  | AL2401     | 3" [76mm]      | 1 3/4" [44mm] |            |            |           |
| CAT NO.              | L   | W             |                |        |           |               |                |            |                |               |            |            |           |
| AL2001               | 1 5/8" [41mm]   | 1 1/2" [38mm] |                |        |           |               |                |            |                |               |            |            |           |
| AL2401               | 3" [76mm]   | 1 3/4" [44mm] |                |        |           |               |                |            |                |               |            |            |           |
| AL2006<br>AL2406     |  <p><b>Cover Clip</b> – For covering joint where lengths of cover or base adjoin. Use with AL2000 and AL2400 Series.</p>   |               |                |        |           |               |                |            |                |               |            |            |           |
| AL2009               |  <p><b>Ground Clamp</b> – Use with AL2000 Series.</p> <p>#8 Ground Stud W/Cup Washer</p>   |               |                |        |           |               |                |            |                |               |            |            |           |
| AL2409               |  <p><b>Ground Clamp</b> – Use with AL2400 Series.</p> <p>#8 Ground Stud W/Cup Washer</p>   |               |                |        |           |               |                |            |                |               |            |            |           |
| AL2010A              |  <p><b>End Fitting</b> – With 1/2" hub adapter. Use with AL2000 Series.</p>  |               |                |        |           |               |                |            |                |               |            |            |           |
| AL2410B2             |  <p><b>End Fitting</b> – With 1/2" plastic KO. Use with AL2400 Series.</p>   |               |                |        |           |               |                |            |                |               |            |            |           |
| AL2010B              |  <p><b>Blank End</b> – Use with AL2000 Series.</p>   |               |                |        |           |               |                |            |                |               |            |            |           |
| AL2410B              |  <p><b>Blank End</b> – Use with AL2400 Series.</p>   |               |                |        |           |               |                |            |                |               |            |            |           |
| AL2051<br>AL2451     |  <p><b>Box Adapter</b> – For feeding raceway from an existing wall outlet.</p>   |               |                |        |           |               |                |            |                |               |            |            |           |
| AL2011<br>AL2411     |  <p><b>90° Flat Elbow</b> – For right angle turn on same surface. Comes with two couplings.</p> <table border="1" style="margin-left: auto; margin-right: auto;"> <thead> <tr> <th>CAT NO.</th> <th>A</th> <th>B</th> <th>C</th> </tr> </thead> <tbody> <tr> <td>AL2011</td> <td>3" [76mm]</td> <td>3" [76mm]</td> <td>1 9/16" [40mm]</td> </tr> <tr> <td>AL2411</td> <td>4" [102mm]</td> <td>4" [102mm]</td> <td>2" [51mm]</td> </tr> </tbody> </table>            | CAT NO.       | A              | B      | C         | AL2011        | 3" [76mm]      | 3" [76mm]  | 1 9/16" [40mm] | AL2411        | 4" [102mm] | 4" [102mm] | 2" [51mm] |
| CAT NO.              | A   | B             | C              |        |           |               |                |            |                |               |            |            |           |
| AL2011               | 3" [76mm]   | 3" [76mm]     | 1 9/16" [40mm] |        |           |               |                |            |                |               |            |            |           |
| AL2411               | 4" [102mm]  | 4" [102mm]    | 2" [51mm]      |        |           |               |                |            |                |               |            |            |           |
| AL2015<br>AL2415     |  <p><b>Tee</b> – For branch connection of two runs of AL2000 Raceway. Three couplings furnished.</p> <table border="1" style="margin-left: auto; margin-right: auto;"> <thead> <tr> <th>CAT NO.</th> <th>A</th> <th>B</th> <th>C</th> </tr> </thead> <tbody> <tr> <td>AL2015</td> <td>1 7/16" [37mm]</td> <td>4" [102mm]</td> <td>1 9/16" [40mm]</td> </tr> <tr> <td>AL2415</td> <td>4" [102mm]</td> <td>6" [152mm]</td> <td>2" [51mm]</td> </tr> </tbody> </table> | CAT NO.       | A              | B      | C         | AL2015        | 1 7/16" [37mm] | 4" [102mm] | 1 9/16" [40mm] | AL2415        | 4" [102mm] | 6" [152mm] | 2" [51mm] |
| CAT NO.              | A   | B             | C              |        |           |               |                |            |                |               |            |            |           |
| AL2015               | 1 7/16" [37mm]  | 4" [102mm]    | 1 9/16" [40mm] |        |           |               |                |            |                |               |            |            |           |
| AL2415               | 4" [102mm]  | 6" [152mm]    | 2" [51mm]      |        |           |               |                |            |                |               |            |            |           |
| AL2416               |  <p><b>Cross</b> – For cross connection of two runs of AL2400 Raceway. Four couplings furnished.</p>  |               |                |        |           |               |                |            |                |               |            |            |           |
| AL2017<br>AL2417     |  <p><b>Internal Elbow</b> – For bending around internal corners. Two couplings furnished.</p> <table border="1" style="margin-left: auto; margin-right: auto;"> <thead> <tr> <th>CAT NO.</th> <th>A</th> </tr> </thead> <tbody> <tr> <td>AL2017</td> <td>3" [76mm]</td> </tr> <tr> <td>AL2417</td> <td>4" [102mm]</td> </tr> </tbody> </table>   | CAT NO.       | A              | AL2017 | 3" [76mm] | AL2417        | 4" [102mm]     |            |                |               |            |            |           |
| CAT NO.              | A   |               |                |        |           |               |                |            |                |               |            |            |           |
| AL2017               | 3" [76mm]   |               |                |        |           |               |                |            |                |               |            |            |           |
| AL2417               | 4" [102mm]  |               |                |        |           |               |                |            |                |               |            |            |           |
| AL2018<br>AL2418     |  <p><b>External Elbow</b> – For making 90° external corners. Two couplings furnished.</p> <table border="1" style="margin-left: auto; margin-right: auto;"> <thead> <tr> <th>CAT NO.</th> <th>A</th> <th>B</th> </tr> </thead> <tbody> <tr> <td>AL2018</td> <td>1 7/8" [48mm]</td> <td>3" [76mm]</td> </tr> <tr> <td>AL2418</td> <td>3" [76mm]</td> <td>5" [127mm]</td> </tr> </tbody> </table>   | CAT NO.       | A              | B      | AL2018    | 1 7/8" [48mm] | 3" [76mm]      | AL2418     | 3" [76mm]      | 5" [127mm]    |            |            |           |
| CAT NO.              | A   | B             |                |        |           |               |                |            |                |               |            |            |           |
| AL2018               | 1 7/8" [48mm]   | 3" [76mm]     |                |        |           |               |                |            |                |               |            |            |           |
| AL2418               | 3" [76mm]   | 5" [127mm]    |                |        |           |               |                |            |                |               |            |            |           |
| AL2038               |  <p><b>Round Fixture Box (Solid Base)</b> – Designed for use in hanging fixtures. Cover takes any device with mounting screw centers of 2 3/4", 3 1/2", and 4 1/16" [70mm, 89mm, and [103mm]. Base has concentric 1/2" and 3/4" KO.</p>   |               |                |        |           |               |                |            |                |               |            |            |           |
| AL2040A              |  <p><b>In-line Single Pole Switch</b> – Single pole 120V switch. Two couplings furnished.</p>   |               |                |        |           |               |                |            |                |               |            |            |           |
| AL2043               |  <p><b>In-line Receptacle</b> – Two 15A, 120V U-ground factory wired receptacles. Couplings furnished.</p>  |               |                |        |           |               |                |            |                |               |            |            |           |

## AL Series (Continued)

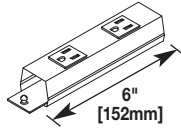
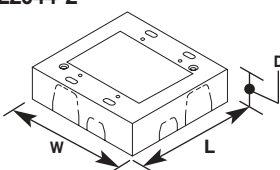
| Catalog No./Item   | Description/Specifications   |                  |               |        |   |        |        |                |                |               |   |          |                |                  |               |   |
|--------------------|--|------------------|---------------|--------|---|--------|--------|----------------|----------------|---------------|---|----------|----------------|------------------|---------------|---|
| AL2043IG           | <b>In-line Isolated Ground Receptacle</b> – Two 15A, 120V factory wired, isolated ground, orange receptacles. Couplings furnished.<br>  |                  |               |        |   |        |        |                |                |               |   |          |                |                  |               |   |
| AL2044<br>AL2044-2 | <b>Deep Device Box</b> – For receptacles and deep devices such as those of signal and alarm systems. Base has open back plate for mounting to existing wall box and solid back plate insert with 1/2" and 3/4" KO to close opening.<br><br><table border="1" style="width: 100%; border-collapse: collapse; margin-top: 10px;"> <thead> <tr> <th>CAT NO.</th> <th>L</th> <th>W</th> <th>D</th> <th>GANG #</th> </tr> </thead> <tbody> <tr> <td>AL2044</td> <td>4 5/8" [117mm]</td> <td>3 1/16" [73mm]</td> <td>2 1/4" [57mm]</td> <td>1</td> </tr> <tr> <td>AL2044-2</td> <td>4 5/8" [117mm]</td> <td>4 27/32" [121mm]</td> <td>2 1/2" [64mm]</td> <td>2</td> </tr> </tbody> </table> | CAT NO.          | L             | W      | D | GANG # | AL2044 | 4 5/8" [117mm] | 3 1/16" [73mm] | 2 1/4" [57mm] | 1 | AL2044-2 | 4 5/8" [117mm] | 4 27/32" [121mm] | 2 1/2" [64mm] | 2 |
| CAT NO.            | L  | W                | D             | GANG # |   |        |        |                |                |               |   |          |                |                  |               |   |
| AL2044             | 4 5/8" [117mm]   | 3 1/16" [73mm]   | 2 1/4" [57mm] | 1      |   |        |        |                |                |               |   |          |                |                  |               |   |
| AL2044-2           | 4 5/8" [117mm]   | 4 27/32" [121mm] | 2 1/2" [64mm] | 2      |   |        |        |                |                |               |   |          |                |                  |               |   |

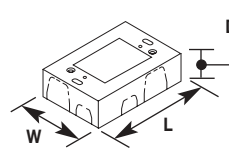
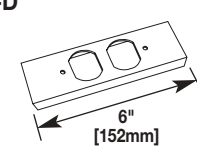
| Catalog No./Item | Description/Specifications  |                  |               |        |   |        |        |                |                |               |   |          |                |                  |               |   |
|------------------|---|------------------|---------------|--------|---|--------|--------|----------------|----------------|---------------|---|----------|----------------|------------------|---------------|---|
| AL2047           | <b>Shallow Switch and Receptacle Box</b> – Designed for standard shallow switches and receptacles. Base has open back plate for mounting to existing wall box and solid back plate insert with 1/2" and 3/4" KO to close opening.<br><br><table border="1" style="width: 100%; border-collapse: collapse; margin-top: 10px;"> <thead> <tr> <th>CAT NO.</th> <th>L</th> <th>W</th> <th>D</th> <th>GANG #</th> </tr> </thead> <tbody> <tr> <td>AL2047</td> <td>4 5/8" [117mm]</td> <td>3 1/16" [73mm]</td> <td>1 3/8" [35mm]</td> <td>1</td> </tr> <tr> <td>AL2047-2</td> <td>4 5/8" [117mm]</td> <td>4 27/32" [121mm]</td> <td>1 3/8" [35mm]</td> <td>2</td> </tr> </tbody> </table> | CAT NO.          | L             | W      | D | GANG # | AL2047 | 4 5/8" [117mm] | 3 1/16" [73mm] | 1 3/8" [35mm] | 1 | AL2047-2 | 4 5/8" [117mm] | 4 27/32" [121mm] | 1 3/8" [35mm] | 2 |
| CAT NO.          | L   | W                | D             | GANG # |   |        |        |                |                |               |   |          |                |                  |               |   |
| AL2047           | 4 5/8" [117mm]  | 3 1/16" [73mm]   | 1 3/8" [35mm] | 1      |   |        |        |                |                |               |   |          |                |                  |               |   |
| AL2047-2         | 4 5/8" [117mm]  | 4 27/32" [121mm] | 1 3/8" [35mm] | 2      |   |        |        |                |                |               |   |          |                |                  |               |   |
| AL2446P-D        | <b>Duplex Receptacle Cover Plate</b> – For in-line mounting of commercially available duplex receptacles.<br>   |                  |               |        |   |        |        |                |                |               |   |          |                |                  |               |   |

## NM2000 Series

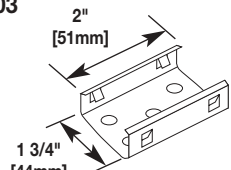
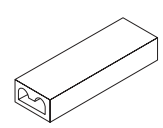
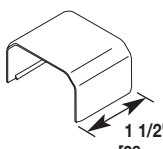
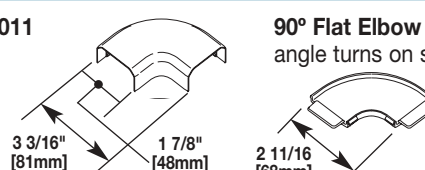
| Catalog No./Item      | Description/Specifications   |            |           |        |          |      |         |           |           |       |         |           |           |              |          |            |           |
|-----------------------|--|------------|-----------|--------|----------|------|---------|-----------|-----------|-------|---------|-----------|-----------|--------------|----------|------------|-----------|
| <b>Base and Cover</b> |  |            |           |        |          |      |         |           |           |       |         |           |           |              |          |            |           |
|                       | <table border="1" style="width: 100%; border-collapse: collapse;"> <thead> <tr> <th>ITEM</th> <th>CAT NO.</th> <th>LENGTH</th> <th>MATERIAL</th> </tr> </thead> <tbody> <tr> <td>Base</td> <td>NM2000B</td> <td>8" [2.4m]</td> <td>PVC-Ivory</td> </tr> <tr> <td>Cover</td> <td>NM2000C</td> <td>8" [2.4m]</td> <td>PVC-Ivory</td> </tr> <tr> <td>Base &amp; Cover</td> <td>NM2000BC</td> <td>5" [1.52m]</td> <td>PVC-Ivory</td> </tr> </tbody> </table> | ITEM       | CAT NO.   | LENGTH | MATERIAL | Base | NM2000B | 8" [2.4m] | PVC-Ivory | Cover | NM2000C | 8" [2.4m] | PVC-Ivory | Base & Cover | NM2000BC | 5" [1.52m] | PVC-Ivory |
| ITEM                  | CAT NO.  | LENGTH     | MATERIAL  |        |          |      |         |           |           |       |         |           |           |              |          |            |           |
| Base                  | NM2000B  | 8" [2.4m]  | PVC-Ivory |        |          |      |         |           |           |       |         |           |           |              |          |            |           |
| Cover                 | NM2000C  | 8" [2.4m]  | PVC-Ivory |        |          |      |         |           |           |       |         |           |           |              |          |            |           |
| Base & Cover          | NM2000BC   | 5" [1.52m] | PVC-Ivory |        |          |      |         |           |           |       |         |           |           |              |          |            |           |
| NM2003                | <b>Supporting Clip</b> – Mount to surface with No. 8 flathead screw. Use with NM2000 Series.<br>  |            |           |        |          |      |         |           |           |       |         |           |           |              |          |            |           |
| W30                   | <b>Pressure-Type Wire Connector</b> – For common connection of two, three, or four No. 12 or No. 14 solid copper conductors. Not for connection of equipment grounding conductor. 300V maximum; 20A 60° C maximum. Not for use with aluminum conductors.<br>  |            |           |        |          |      |         |           |           |       |         |           |           |              |          |            |           |
| NM2006                | <b>Cover Clip</b> – For covering joint where lengths of cover or base adjoin. Use with NM2000 Series.<br>   |            |           |        |          |      |         |           |           |       |         |           |           |              |          |            |           |
| NM2011                | <b>90° Flat Elbow</b> – For right angle turns on same surface.<br>  |            |           |        |          |      |         |           |           |       |         |           |           |              |          |            |           |

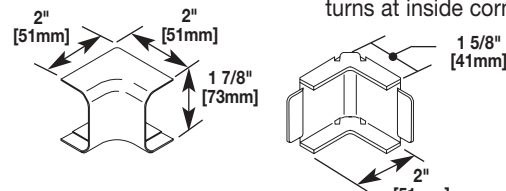
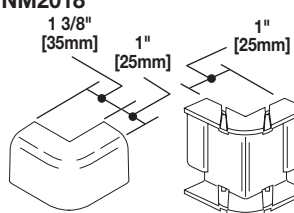
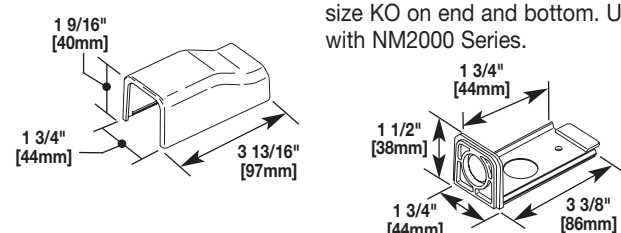
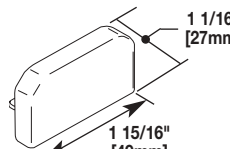
| Catalog No./Item | Description/Specifications  |
|------------------|---|
| NM2017           | <b>Internal Elbow</b> – For right turns at inside corners.<br>                               |
| NM2018           | <b>External Elbow</b> – Used for making 90° turns at outside corners.<br>                   |
| NM2010A          | <b>Entrance End</b> – Has 1/2" trade size KO on end and bottom. Use with NM2000 Series.<br> |
| NM2010B          | <b>Blank End Fitting</b> – Use with NM2000 Series.<br>                                      |

## NM2000 Series (Continued)

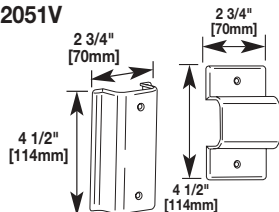
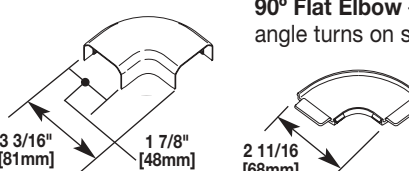
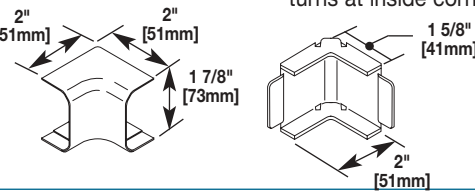
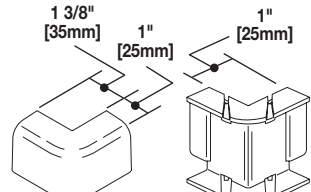
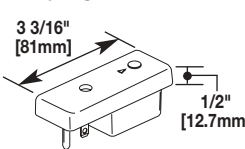
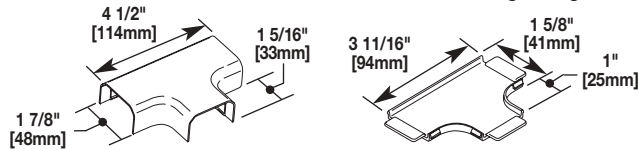
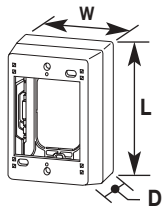
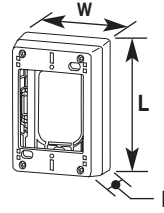
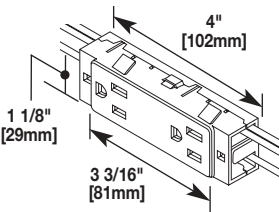
| Catalog No./Item  | Description/Specifications  |                |               |        |   |        |        |                |           |               |   |          |                |                |               |   |
|---|---|----------------|---------------|--------|---|--------|--------|----------------|-----------|---------------|---|----------|----------------|----------------|---------------|---|
| <b>NM2051H</b><br><b>NM2051V</b>         | <b>Wall Box Adapter</b> – For feeding raceway from an existing wall outlet; horizontal or vertical applications. Provides complete access to wall box for connections.  |                |               |        |   |        |        |                |           |               |   |          |                |                |               |   |
| <b>NM2011</b>                            | <b>90° Flat Elbow</b> – For right angle turns on same surface.  |                |               |        |   |        |        |                |           |               |   |          |                |                |               |   |
| <b>NM2017</b>                            | <b>Internal Elbow</b> – For right turns at inside corners.  |                |               |        |   |        |        |                |           |               |   |          |                |                |               |   |
| <b>NM2018</b>                           | <b>External Elbow</b> – Used for making 90° turns at outside corners.   |                |               |        |   |        |        |                |           |               |   |          |                |                |               |   |
| <b>NM2027S</b>                         | <b>Surge Suppression Module</b> – Field installed replacement module for SGB Series surge strips. Protects all receptacles on the strip. Contains indicator light for proper operation of the suppression module. Suppression three legs.   |                |               |        |   |        |        |                |           |               |   |          |                |                |               |   |
| <b>NM2015</b>                           | <b>Tee</b> – For branches at right angles.  |                |               |        |   |        |        |                |           |               |   |          |                |                |               |   |
| <b>NM2044</b>                           | <b>Extra Deep Device Box</b> – For mounting power/communication device when additional depth is required. Has combination twistouts for 2700, 2800, 2900, and NM2000.   |                |               |        |   |        |        |                |           |               |   |          |                |                |               |   |
|   | <table border="1" style="width: 100%; border-collapse: collapse;"> <thead> <tr> <th>CAT NO.</th> <th>L</th> <th>W</th> <th>D</th> <th>GANG #</th> </tr> </thead> <tbody> <tr> <td>NM2044</td> <td>4 3/4" [121mm]</td> <td>3" [76mm]</td> <td>1 3/4" [44mm]</td> <td>1</td> </tr> <tr> <td>NM2044-2</td> <td>4 3/4" [121mm]</td> <td>4 7/8" [124mm]</td> <td>1 3/4" [44mm]</td> <td>2</td> </tr> </tbody> </table> | CAT NO.        | L             | W      | D | GANG # | NM2044 | 4 3/4" [121mm] | 3" [76mm] | 1 3/4" [44mm] | 1 | NM2044-2 | 4 3/4" [121mm] | 4 7/8" [124mm] | 1 3/4" [44mm] | 2 |
| CAT NO.   | L   | W              | D             | GANG # |   |        |        |                |           |               |   |          |                |                |               |   |
| NM2044  | 4 3/4" [121mm]  | 3" [76mm]      | 1 3/4" [44mm] | 1      |   |        |        |                |           |               |   |          |                |                |               |   |
| NM2044-2  | 4 3/4" [121mm]  | 4 7/8" [124mm] | 1 3/4" [44mm] | 2      |   |        |        |                |           |               |   |          |                |                |               |   |
| <b>NM2048</b>                          | <b>Sure Snap® Device Box</b> – Cover snaps onto base, no screws required. Cover has twistouts on all sides. Rectangular KO in base for extension to wall box.   |                |               |        |   |        |        |                |           |               |   |          |                |                |               |   |
|   | <table border="1" style="width: 100%; border-collapse: collapse;"> <thead> <tr> <th>CAT NO.</th> <th>L</th> <th>W</th> <th>D</th> <th>GANG #</th> </tr> </thead> <tbody> <tr> <td>NM2048</td> <td>4 3/4" [121mm]</td> <td>3" [76mm]</td> <td>1 3/4" [44mm]</td> <td>1</td> </tr> <tr> <td>NM2048-2</td> <td>4 3/4" [121mm]</td> <td>4 7/8" [124mm]</td> <td>1 3/4" [44mm]</td> <td>2</td> </tr> </tbody> </table> | CAT NO.        | L             | W      | D | GANG # | NM2048 | 4 3/4" [121mm] | 3" [76mm] | 1 3/4" [44mm] | 1 | NM2048-2 | 4 3/4" [121mm] | 4 7/8" [124mm] | 1 3/4" [44mm] | 2 |
| CAT NO.   | L   | W              | D             | GANG # |   |        |        |                |           |               |   |          |                |                |               |   |
| NM2048  | 4 3/4" [121mm]  | 3" [76mm]      | 1 3/4" [44mm] | 1      |   |        |        |                |           |               |   |          |                |                |               |   |
| NM2048-2  | 4 3/4" [121mm]  | 4 7/8" [124mm] | 1 3/4" [44mm] | 2      |   |        |        |                |           |               |   |          |                |                |               |   |
| <b>NM2027-15</b><br><b>NM2027-20</b>  | <b>Replacement Receptacles</b> – 15A and 20A replacement devices. 6" [152mm] wire leads each side.  |                |               |        |   |        |        |                |           |               |   |          |                |                |               |   |

### Specifications for Surge Module

|  |  |
|--|--|
| Standards  | UL recognized under the component program of UL Standard 1449, as defined by ANSI/NFPA 70-1990.      |
| Service Voltage  | 120Vrms nominal operating voltage.   |
| Maximum Continuous Operating Voltage                     | 150Vrms.   |
| Suppression Voltage (Three Line Protection)              | Complete surge protective device as assessed by UL:  |
| Actual let through voltage at 6kA 1.2/50µs, 500A, 8/20µs | 340 Volts Peak L-N.  |
| Maximum Single Withstand Surge Current                   | No less than 39kA individually between L-N, L-G, and N-G, based on the sum of the device components. |

| Suppression Mode | UL1449 Suppression Voltage |
|------------------|----------------------------|
| Line – Neutral   | 500V                       |
| Line – Ground    | 500V                       |
| Neutral – Ground | 500V                       |

## Wiring Configuration

### With Snapicoil



**GB Series:**  
3-wire, #12 THHN (1 hot, 1 neutral and 1 ground), 1 circuit; has insulated grounding conductor.



**GBA Series:**  
4-wire, #12 THHN (2 hot, 1 neutral and 1 ground), 2 circuit; outlets wired alternately; has insulated grounding conductor.

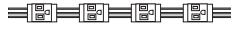

**IG Series:**  
3-wire, #12 THHN (1 hot, 1 neutral and 1 ground), 1 circuit; has insulated-isolated grounding conductor. Orange receptacles.

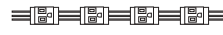

**GB Series:**  
3-wire, #12 THHN (1 hot, 1 neutral and 1 ground), 1 circuit; has insulated grounding conductor.



**GBA Series:**  
4-wire, #12 THHN (2 hot, 1 neutral and 1 ground), 2 circuit; outlets wired alternately; has insulated grounding conductor.

**NOTE: SNAPICOIL REELS** on custom order. Snapicoil is available on reels if lengths greater than 50' are needed, or if multiple lengths are required for production-type jobs. The maximum length per reel is 240' for Snapicoil with outlets 12" and 18" on centers; 500' with outlets 30" on center. Packaging includes the necessary number of lengths of base, holecut cover, wire clips, and couplings for complete installation. Price and delivery information should be obtained prior to specifying or ordering. To specify or order, add R to the Snapicoil number. Ex: V20GB06R. **Other outlet spacings available on custom order.**

Receptacles are made from high impact thermoplastic. V2000 Plugmold is supplied with two (2) V2010B Blank End Fittings and (1) 2001 Base Coupling. NM2000 Plugmold strips are supplied with two (2) NM2010B Blank End Fittings.

## Plugmold Multi Outlet Strip

| CATALOG NO.    | LENGTH |         | WIRING CONFIG | OUTLETS         |               | HOUSING       |
|----------------|--------|---------|---------------|-----------------|---------------|---------------|
|                |        |         |               | CENTER DISTANCE | QUANTITY      |               |
| 20GB306*       | 3'     | [915mm] | GB            | 6" [152mm]      | 6 Single 15A  | Steel         |
| AL20GB306      | 3'     | [915mm] | GB            | 6" [152mm]      | 6 Single 15A  | Aluminum      |
| AL20IG306      | 3'     | [915mm] | IG            | 6" [152mm]      | 6 Single 15A  | Aluminum      |
| 24S3612GBX99IV | 3'     | [915mm] | GB            | 12" [305mm]     | 3 Duplex 20A  | Steel – Ivory |
| 24S3612GBA99IV | 3'     | [915mm] | GBA           | 12" [305mm]     | 3 Duplex 20A  | Steel – Ivory |
| NM24GB412      | 4'     | [1.2m]  | GB            | 12" [305mm]     | 4 Duplex 20A  | PVC – Ivory   |
| NM24GBA412     | 4'     | [1.2m]  | GBA           | 12" [305mm]     | 4 Duplex 20A  | PVC – Ivory   |
| NM20GB412      | 4'     | [1.2m]  | GB            | 12" [305mm]     | 4 Duplex 15A  | PVC – Ivory   |
| NM20GBA412     | 4'     | [1.2m]  | GBA           | 12" [305mm]     | 4 Duplex 15A  | PVC – Ivory   |
| NM20IG412      | 4'     | [1.2m]  | IG            | 12" [305mm]     | 4 Duplex 15A  | PVC – Ivory   |
| NM20SGB412     | 4'     | [1.2m]  | SGB-Surge     | 12" [305mm]     | 3 Duplex 15A  | PVC – Ivory   |
| 20GB506*       | 5'     | [1.5m]  | GB            | 6" [152mm]      | 10 Single 15A | Steel         |
| 20GB512*       | 5'     | [1.5m]  | GB            | 12" [305mm]     | 5 Single 15A  | Steel         |
| 20GBA512*      | 5'     | [1.5m]  | GBA           | 12" [305mm]     | 5 Single 15A  | Steel         |
| 20IG512*       | 5'     | [1.5m]  | IG            | 12" [305mm]     | 5 Single 15A  | Steel         |
| 24S6012GBX99IV | 5'     | [1.5m]  | GB            | 12" [305mm]     | 5 Duplex 20A  | Steel – Ivory |
| 24S6012IGX99IV | 5'     | [1.5m]  | IG            | 12" [305mm]     | 5 Duplex 20A  | Steel – Ivory |
| 24S6012GBA99IV | 5'     | [1.5m]  | GBA           | 12" [305mm]     | 5 Duplex 20A  | Steel – Ivory |
| AL20GB506      | 5'     | [1.5m]  | GB            | 6" [152mm]      | 10 Single 15A | Aluminum      |
| AL20GB512      | 5'     | [1.5m]  | GB            | 12" [305mm]     | 5 Single 15A  | Aluminum      |
| AL20IG506      | 5'     | [1.5m]  | IG            | 6" [152mm]      | 10 Single 15A | Aluminum      |
| NM24GB512      | 5'     | [1.5m]  | GB            | 12" [305mm]     | 5 Duplex 20A  | PVC – Ivory   |
| NM24GB530      | 5'     | [1.5m]  | GB            | 30" [760mm]     | 2 Duplex 20A  | PVC – Ivory   |
| NM24GBA512     | 5'     | [1.5m]  | GBA           | 12" [305mm]     | 5 Duplex 20A  | PVC – Ivory   |
| NM20GB512      | 5'     | [1.5m]  | GB            | 12" [305mm]     | 5 Duplex 15A  | PVC – Ivory   |
| NM20GB515      | 5'     | [1.5m]  | GB            | 15" [381mm]     | 4 Duplex 15A  | PVC – Ivory   |
| NM20GB530      | 5'     | [1.5m]  | GB            | 30" [760mm]     | 2 Duplex 15A  | PVC – Ivory   |
| NM20GBA512     | 5'     | [1.5m]  | GBA           | 12" [305mm]     | 5 Duplex 15A  | PVC – Ivory   |
| NM20IG512      | 5'     | [1.5m]  | IG            | 12" [305mm]     | 5 Duplex 15A  | PVC – Ivory   |
| NM20SGB512     | 5'     | [1.5m]  | SGB-Surge     | 12" [305mm]     | 4 Duplex 15A  | PVC – Ivory   |

\* Use "V" prefix for Ivory finish and "G" prefix for Gray finish.



## Plugmold Multi Outlet Strip (Continued)

| CATALOG NO.    | LENGTH    | WIRING CONFIG | OUTLETS         |               | HOUSING       |
|----------------|-----------|---------------|-----------------|---------------|---------------|
|                |           |               | CENTER DISTANCE | QUANTITY      |               |
| 20GB606*       | 6' [1.8m] | GB            | 6" [152mm]      | 12 Single 15A | Steel         |
| 20GB609*       | 6' [1.8m] | GB            | 9" [229mm]      | 8 Single 15A  | Steel         |
| 20GB612*       | 6' [1.8m] | GB            | 12" [305mm]     | 6 Single 15A  | Steel         |
| 20GB618*       | 6' [1.8m] | GB            | 18" [457mm]     | 4 Single 15A  | Steel         |
| 20GBA609*      | 6' [1.8m] | GBA           | 9" [229mm]      | 8 Single 15A  | Steel         |
| 20GBA612*      | 6' [1.8m] | GBA           | 12" [305mm]     | 6 Single 15A  | Steel         |
| 20GBA618*      | 6' [1.8m] | GB            | 18" [457mm]     | 4 Single 15A  | Steel         |
| 20IG606*       | 6' [1.8m] | IG            | 6" [152mm]      | 12 Single 15A | Steel         |
| 24S7212GBX99IV | 6' [1.8m] | GB            | 12" [305mm]     | 6 Duplex 20A  | Steel – Ivory |
| 24S7224GBA99IV | 6' [1.8m] | GBA           | 24" [608mm]     | 3 Duplex 20A  | Steel – Ivory |
| 24S7218GBX99IV | 6' [1.8m] | GB            | 18" [457mm]     | 4 Duplex 20A  | Steel – Ivory |
| 24S7224GBX99IV | 6' [1.8m] | GB            | 24" [608mm]     | 5 Duplex 20A  | Steel – Ivory |
| 24S7218IGX99IV | 6' [1.8m] | IG            | 18" [457mm]     | 4 Duplex 20A  | Steel – Ivory |
| 24S7212IGX99IV | 6' [1.8m] | IG            | 12" [305mm]     | 6 Duplex 20A  | Steel – Ivory |
| 24S7224IGX99IV | 6' [1.8m] | IG            | 24" [608mm]     | 3 Duplex 20A  | Steel – Ivory |
| 24S7212GBA99IV | 6' [1.8m] | GBA           | 12" [305mm]     | 6 Duplex 20A  | Steel – Ivory |
| 24S7218GBA99IV | 6' [1.8m] | GBA           | 18" [457mm]     | 4 Duplex 20A  | Steel – Ivory |
| AL20GB606      | 6' [1.8m] | GB            | 6" [152mm]      | 12 Single 15A | Aluminum      |
| AL20GB612      | 6' [1.8m] | GB            | 12" [305mm]     | 6 Single 15A  | Aluminum      |
| AL20GB618      | 6' [1.8m] | GB            | 18" [457mm]     | 4 Single 15A  | Aluminum      |
| AL20GBA606     | 6' [1.8m] | GBA           | 6" [152mm]      | 12 Single 15A | Aluminum      |
| AL20GBA612     | 6' [1.8m] | GBA           | 12" [305mm]     | 6 Single 15A  | Aluminum      |
| AL20GBA618     | 6' [1.8m] | GBA           | 18" [457mm]     | 4 Single 15A  | Aluminum      |
| AL20IG606      | 6' [1.8m] | IG            | 6" [152mm]      | 12 Single 15A | Aluminum      |
| AL20IG618      | 6' [1.8m] | IG            | 18" [457mm]     | 4 Single 15A  | Aluminum      |
| NM24GB612      | 6' [1.8m] | GB            | 12" [305mm]     | 6 Duplex 20A  | PVC-Ivory     |
| NM24GB618      | 6' [1.8m] | GB            | 18" [457mm]     | 4 Duplex 20A  | PVC-Ivory     |
| NM24GBA612     | 6' [1.8m] | GBA           | 12" [305mm]     | 6 Duplex 20A  | PVC-Ivory     |
| NM20GB609      | 6' [1.8m] | GB            | 9" [229mm]      | 8 Duplex 15A  | PVC-Ivory     |
| NM20GB612      | 6' [1.8m] | GB            | 12" [305mm]     | 6 Duplex 15A  | PVC-Ivory     |
| NM20GB618      | 6' [1.8m] | GB            | 18" [457mm]     | 4 Duplex 15A  | PVC-Ivory     |
| NM20GBA609     | 6' [1.8m] | GBA           | 9" [229mm]      | 8 Duplex 15A  | PVC-Ivory     |
| NM20GBA612     | 6' [1.8m] | GBA           | 12" [305mm]     | 6 Duplex 15A  | PVC-Ivory     |
| NM20IG612      | 6' [1.8m] | IG            | 12" [305mm]     | 6 Duplex 15A  | PVC-Ivory     |
| NM20SGB612     | 6' [1.8m] | SGB-Surge     | 12" [305mm]     | 5 Duplex 15A  | PVC-Ivory     |
| NM20SGB618     | 6' [1.8m] | SGB-Surge     | 18" [457mm]     | 3 Duplex 15A  | PVC-Ivory     |

\* Use "V" prefix for Ivory finish and "G" prefix for Gray finish. Outlets match raceway finish.

## Plugmold with Snapicoil Harness

| CATALOG NO. | LENGTH | WIRING CONFIG | OUTLETS (15A 120V NEMA 5-15SR) |           | HOLE CUT COVER |           | HOUSING     |
|-------------|--------|---------------|--------------------------------|-----------|----------------|-----------|-------------|
|             |        |               | CENTER DISTANCE                | QUANTITY  | QUANTITY       | LENGTH    |             |
| 20GB12*     | 48'    | GB            | 12" [305mm]                    | 48 Single | 8              | 6' [1.8m] | Steel       |
| 20GB18*     | 48'    | GB            | 18" [457mm]                    | 32 Single | 8              | 6' [1.8m] | Steel       |
| V20GB30     | 50'    | GB            | 30" [760mm]                    | 20 Single | 10             | 5' [1.5m] | Steel-Ivory |
| NM20GB12    | 48'    | GB            | 12" [152mm]                    | 24 Duplex | 8              | 6' [1.8m] | PVC-Ivory   |
| 20GBA12*    | 48'    | GBA           | 12" [305mm]                    | 48 Single | 8              | 6' [1.8m] | Steel       |
| NM20GBA12   | 48'    | GBA           | 12" [305mm]                    | 24 Duplex | 8              | 6' [1.8m] | PVC-Ivory   |

\* Use "V" prefix for Ivory finish and "G" prefix for Gray finish.

## Cord-Ended Plugmold Series

| CAT NO. | UNIT LENGTH | OUTLETS QUANTITY | CORD SET LENGTH | TYPE     | SWITCH | CIRCUIT BREAKER | HOUSING   |
|---------|-------------|------------------|-----------------|----------|--------|-----------------|-----------|
| NM20-C3 | 3' [.92m]   | 3 Duplex         | 6' [1.8m]       | 14/3 SJT | Yes    | Yes             | PVC-Ivory |
| 20-C2*  | 3' 4" [1m]  | 6 Single         | 6' [1.8m]       | 12/3 SJT | No     | Yes             | Steel     |
| NM20-C4 | 4' [1.2m]   | 4 Duplex         | 6' [1.8m]       | 14/3 SJT | Yes    | Yes             | PVC-Ivory |
| NM20-C5 | 5' [1.5m]   | 5 Duplex         | 6' [1.8m]       | 14/3 SJT | Yes    | Yes             | PVC-Ivory |
| NM20-C6 | 6' [1.8m]   | 6 Duplex         | 6' [1.8m]       | 14/3 SJT | Yes    | Yes             | PVC-Ivory |

\* Use "V" prefix for Ivory finish and "G" prefix for Gray finish.

## Wire Fill Capacities for Power

| CABLE TYPE                           | WIRE SIZE THHN/THWN | O.D.   |       | NUMBER OF CONDUCTORS (40% FILL) |       |        |        |        |
|--------------------------------------|---------------------|--------|-------|---------------------------------|-------|--------|--------|--------|
|                                      |                     | Inches | [mm]  | V2000                           | V2400 | NM2000 | AL2000 | AL2400 |
| POWER WIRING WITHOUT DEVICES         | 8 AWG               | 0.216  | [5.5] | -                               | -     | -      | 12     | 18     |
|                                      | 10 AWG              | 0.166  | [4.2] | -                               | 26    | 15     | 24     | 37     |
|                                      | 12 AWG              | 0.130  | [3.3] | 7*                              | 41    | 31     | 38     | 58     |
|                                      | 14 AWG              | 0.111  | [2.8] | 7*                              | 57    | 45     | 51     | 78     |
| POWER WIRING WITH DEVICES (PLUGMOLD) | 8 AWG               | 0.218  | [5.5] | -                               | 2     | -      | -      | 4      |
|                                      | 10 AWG              | 0.153  | [3.9] | -                               | 6     | -      | 3      | 8      |
|                                      | 12 AWG              | 0.122  | [3.1] | 5*                              | 10    | 8**    | 6      | 12     |
|                                      | 14 AWG              | 0.105  | [2.7] | 5*                              | -     | 8**    | 8      | 16     |

\*Wire capacity limited to maximum of seven conductors due to .025" [.6mm] material thickness of cover.

\*\*Including one hot, neutral, and ground wire from the receptacle.

## Cross Section

| Catalog No./Item   | Description/Specifications  | Catalog No./Item | Description/Specifications  |
|--|---|------------------|---|
| 2000   | <b>Base and Cover –</b><br>Base – 2000B .040" [1.0mm] steel.<br>Cover – 2000C .025" [.6mm] steel.                   | AL2400           | <b>Base and Cover –</b> 6063-T5<br>extruded aluminum, satin<br>anodized finish, .060"<br>[1.5mm] nominal thickness. |
| <p style="text-align: right;">Cross-Sectional Area:<br/>0.80in<sup>2</sup> [516mm<sup>2</sup>]</p> | <p style="text-align: right;">Cross-Sectional Area:<br/>1.7in<sup>2</sup> [1097mm<sup>2</sup>]</p>                  |                  |   |
| V2400  | <b>Base and Cover –</b><br>Base – V2400B .040" [1.0mm] steel.<br>Cover – V2400C .040" [1.0mm] steel.                | NM2000           | <b>Base and Cover –</b> Extruded PVC,<br>ivory textured finish.   |
| <p style="text-align: right;">Cross-Sectional Area:<br/>1.39in<sup>2</sup> [897mm<sup>2</sup>]</p> | <p style="text-align: right;">Cross-Sectional Area:<br/>1.14in<sup>2</sup> [735mm<sup>2</sup>]</p>                  |                  |   |
| AL2000   | <b>Base and Cover –</b> 6063-T5<br>extruded aluminum, satin<br>anodized finish, .060"<br>[1.5mm] nominal thickness. |                  |   |
| <p style="text-align: right;">Cross-Sectional Area:<br/>1in<sup>2</sup> [645mm<sup>2</sup>]</p>    |   |                  |   |

# Datacom Connectivity Options

Now you have a wide range of options for providing datacom connectivity into Wiremold® Cable Management Systems. They are:

- Ortronics® TracJack® and Series II Modular Connectivity Solutions
- Pass & Seymour Activate™ Modular Inserts
- Open System Communication Modules

|      |      |      |
|------|------|------|
| ORT  | ORT  | ORT  |
| P&S  | P&S  | P&S  |
| OPEN | OPEN | OPEN |

Use these icons to determine connectivity options for each Wiremold System component:

ORT

## Ortronics® Connectivity

P&S

### TracJack® Individual Jack System

OPEN

- Front-loading, snap-in design supports future moves adds and changes
- Inserts for voice, data, audio, and video
- Available Category 3, 5e, 6, USOC 6-position, and other media
- Flat or angled 45° exit configurations
- Choice of 13 colors and color matched to Wiremold Systems
- Universal T568A/B wiring format



### Series II Front-Loading, Module System

- Module design features easy snap-in front-loading design
- Linear 110 punch down format for easy termination
- Inserts for voice, data, audio, and video
- Available Category 3, 5e, 6, USOC 6-position, and other media
- Available in flat or angled 45° exit configurations
- Color matched to Wiremold Systems



For detailed product selection refer to the Ortronics Catalog or visit [www.ortronics.com](http://www.ortronics.com).

ORT

## Pass & Seymour Legrand Network Wiring

P&S

### Activate™ Series Front-Loading Inserts

OPEN

- Modular inserts for voice, data, audio and video applications
- Front-load, snap-in design
- Color and texture matched to Wiremold Systems
- Available Category 3, 5e, 6, as well as 6-position USOC
- Universal T568A/B wiring format



For detailed product selection refer to the Pass & Seymour Network Wiring Catalog or visit [www.passandseymour.com](http://www.passandseymour.com).

ORT

## Open Connectivity Solutions

P&S

### Wiremold Open System Communications Modules

OPEN

- Accommodate a wide range of manufacturers' communications outlets including keystone jacks, as well as proprietary solutions from Avaya (Lucent) and NORDX
- Modules insert into a wide range of Wiremold Systems
- Pre-punched faceplates accept common communication devices



**NOTE:** For more information on integrating connectivity into Wiremold Cable Management Systems contact the Wiremold Applications Engineering Team or your local Wiremold Sales Representative.

# WIREMOLD



#### Wiremold / Legrand

U.S. and International:

60 Woodlawn Street • West Hartford, CT 06110

1-800-621-0049 • FAX 860-232-2062 • Outside U.S. 860-233-6251

Canada:

570 Applewood Crescent • Vaughan, Ontario L4K 4B4

1-800-723-5175 • FAX 905-738-9721

