

Key Features:

- **12-inch High-Excursion LF Transducer**
- **Trapezoidal Shape allows for flexible placement**
- **Secure Reinforced Cabinet Construction with Mounting Hardware included**
- **Extremely High Power Handling**
- **High Sensitivity**
- **Paintable Enclosure available in Black or White Finishes**
- **Dual Voice Coil Design accommodates both Stereo Channels**
- **Crossed-Over Pass-Thru Connections for up to 4 Satellite Speakers**



General Description:

The Electro-Voice® EVID 12.1 is a subwoofer system designed to complement the EVID™ line of full-range loudspeakers. The 12.1 is ideal for supplementing the bass response of any EVID™ model in an indoor application. It is particularly useful in sports bars, dance floors, retail environments, health clubs, restaurants, etc. The 12.1 adds the extra dimension of a powerful low end where foreground music is desired.

The 12.1's slot-loaded design allows for flexible mounting and placement while delivering the smoothest bass response possible. The 12-inch high-excursion woofer, with its dual voice-coil design, enables both the L/R channels to feed into the speaker while at the same time providing crossed-over outputs for up to 4 satellite speakers. If desired, the 12.1 can be powered separately for an even more powerful presence. The 12.1 features reinforced steel-fastener construction that allows for a variety of mounting configurations.

The 12.1 is available in black or white, and can easily be painted to match the decor. All mounting hardware is included.

Technical Specifications:

Freq. Response ¹ (-10 dB):	40 Hz - 180 Hz
Power Handling:	175 W Cont. Program Per Coil
Sensitivity ¹ (SPL 1W/1m):	106 dB
Impedance:	8 Ohms
Max Calculated SPL:	125 dB
LF Transducer:	12" (300 mm) High-Excursion Dual Voice-Coil
Terminals:	Spring-Loaded
Enclosure Material:	MDF, Steel Fastener Reinforced
Included Accessories:	Mounting Bracket and Hardware
Dim (H x W x D):	16.25" x 23.0" x 12.0" (412 mm x 584 mm x 305 mm)
Net Weight:	40.0 lbs (18.1 kg)
Shipping Weight:	48.0 lbs (20.0 kg)

¹ 1/8" Space (Corner Mounting)

Architects' & Engineers' Specifications:

The loudspeaker shall be a single driver system consisting of one 12-inch (300 mm) low-frequency and frequency-dividing network installed in a vented, slot-loaded enclosure. The LF transducer shall have dual voice coils to allow for stereo (L/R) inputs. The network shall include crossed-over outputs for up to 4 satellite speakers. The loudspeaker system shall meet the following performance criteria: Power handling, 175 watts long-term program per voice coil using EIA RS-426A pink noise (6 dB crest factor). Frequency response, 40 Hz–140 Hz (-10 dB from rated sensitivity). Pressure sensitivity, 106 dB at one watt, 100 Hz–10 kHz at one meter. Impedance, 8 ohms nominal, 6 ohms minimum. The enclosure shall be MDF and constructed with both glue and steel fasteners. The enclosure shall be 16.5" (412 mm) high, 23" (584 mm) wide, 12" (305 mm) deep. The finish shall be a paintable black or white. The grille shall be acoustically transparent foam. The support bracket shall be low profile and integral with the enclosure. The cabinet shall be designed for ceiling mounting with additional accessory materials. All standard mounting hardware shall be included for wall or corner placement. The loudspeaker shall be the Electro-Voice® EVID model 12.1.

Frequency Response:

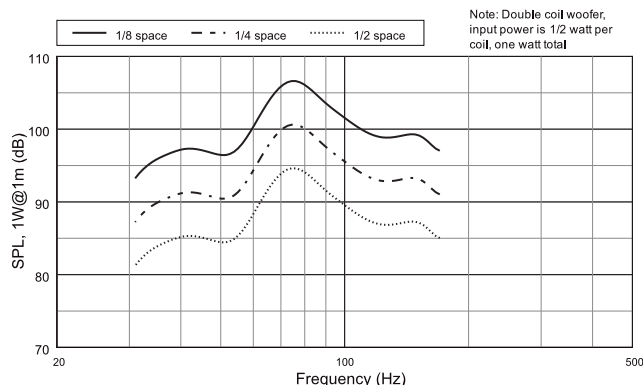

Block Diagram:

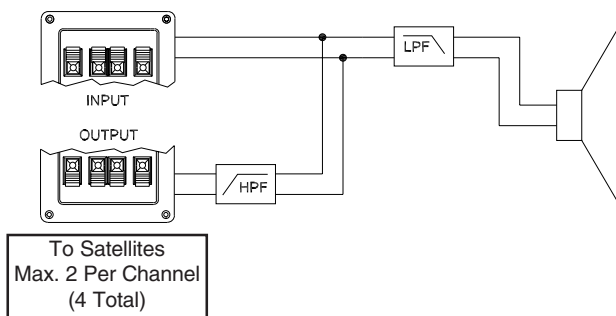

Impedance:

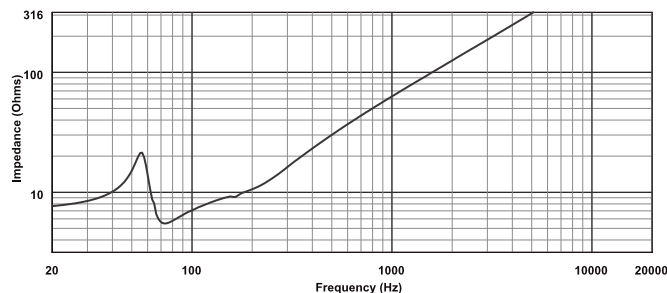

Dimension Drawings:

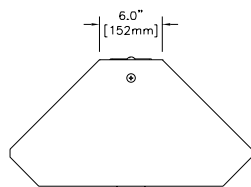

Top View

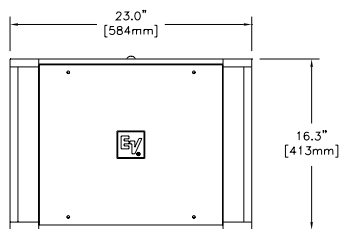

Front View

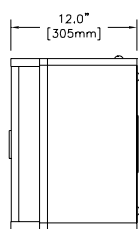

Side View

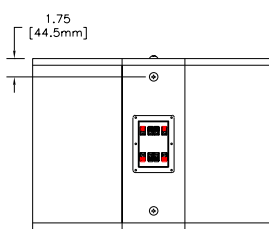

Rear View

Performance Match:

- EVID 3.2(t) Surface Mount Speaker
- EVID 4.2(t) Surface Mount Speaker
- EVID 6.2(t) Surface Mount Speaker
- CPS-1 Power Amplifier
- CPS-2 Power Amplifier
- CPS-2T Power Amplifier
- MA-1206 Mixer Amplifier
- MA-1212 Mixer Amplifier

EVID 12.1 Part Number

- 301048-001



12000 Portland Avenue South, Burnsville, MN 55337
Phone: 952/884-4051, Fax: 952/884-0043

www.electrovoice.com

© Telex Communications, Inc. 10/2002

Part Number 38109-984 Rev B

U.S.A. and Canada only. For customer orders, contact Customer Service at:

800/392-3497 Fax: 800/955-6831

Europe, Africa, and Middle East only. For customer orders, contact Customer Service at:

+ 49 9421-706 0 Fax: + 49 9421-706 265

Other International locations. For customer orders, contact Customer Service at:

+ 1 952 884-4051 Fax: + 1 952 736-4212

For warranty repair or service information, contact the Service Repair department at:

800/685-2606

For technical assistance, contact Technical Support at: 866/78AUDIO

Specifications subject to change without notice.