

Features

- 0.2 inch digit height.
- Low current operation.
- Excellent character appearance.
- Mechanically rugged.
- Package :300pcs / reel.
- Gray face, white segment.
- Moisture sensitivity level : level 2a.
- RoHS compliant.

Description

The High Efficiency Red source color devices are made with Gallium Arsenide Phosphide on Gallium Phosphide Orange Light Emitting Diode.

Package Dimensions & Internal Circuit Diagram

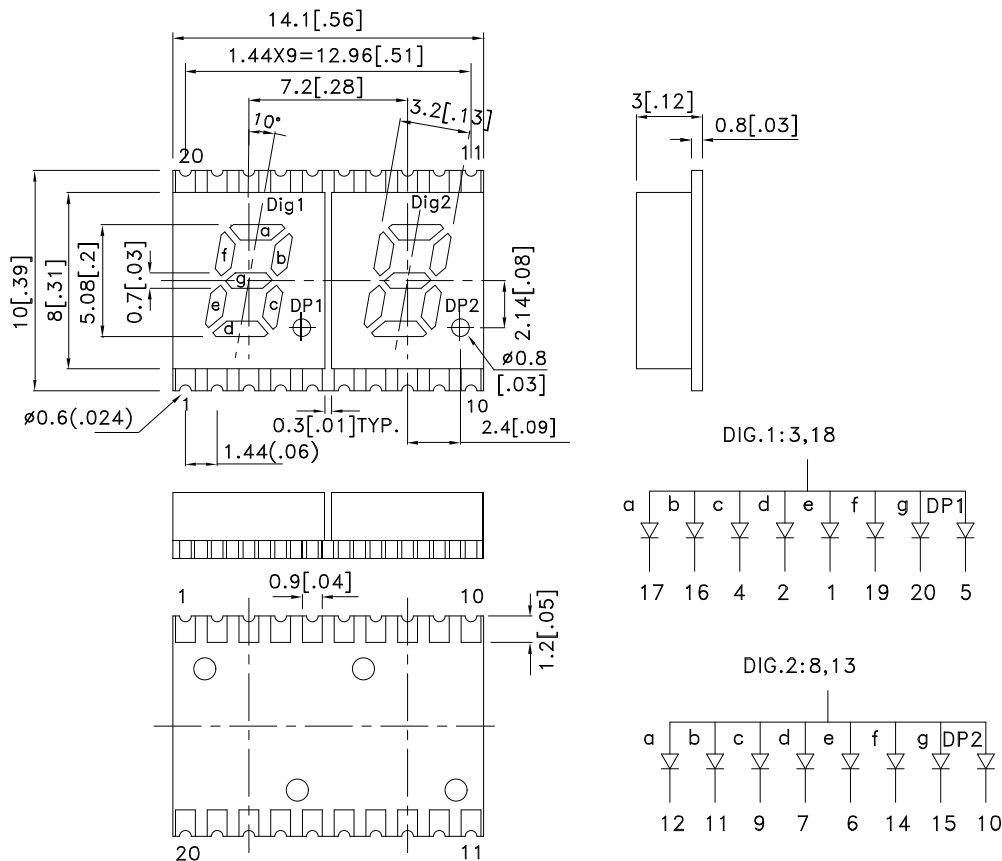

Notes:

1. All dimensions are in millimeters (inches), Tolerance is $\pm 0.25(0.01)$ unless otherwise noted.
2. The specifications, characteristics and technical data described in the datasheet are subject to change without prior notice.
3. The gap between the reflector and PCB shall not exceed 0.25mm.



Selection Guide

Part No.	Dice	Lens Type	Iv (ucd) [1] @ 10mA		Description
			Min.	Typ.	
KCDA02-101	High Efficiency Red (GaAsP/GaP)	White Diffused	1400	3200	Common Anode, Rt. Hand Decimal.
			*360	*950	

Note:

1. Luminous intensity/ luminous Flux: +/-15%.

*Luminous intensity value is traceable to the CIE127-2007 compliant national standards.

Electrical / Optical Characteristics at TA=25°C

Symbol	Parameter	Device	Typ.		Max.	Units	Test Conditions
λ_{peak}	Peak Wavelength	High Efficiency Red	627	*627		nm	I _F =20mA
λ_D [1]	Dominant Wavelength	High Efficiency Red	625	*617		nm	I _F =20mA
$\Delta\lambda_{1/2}$	Spectral Line Half-width	High Efficiency Red	45			nm	I _F =20mA
C	Capacitance	High Efficiency Red	15			pF	V _F =0V;f=1MHz
V _F [2]	Forward Voltage	High Efficiency Red	2.0		2.5	V	I _F =20mA
I _R	Reverse Current	High Efficiency Red			10	uA	V _R =5V

Notes:

1.Wavelength: +/-1nm.

2. Forward Voltage: +/-0.1V.

*Wavelength value is traceable to the CIE127-2007 compliant national standards.

Absolute Maximum Ratings at TA=25°C

Parameter	High Efficiency Red	Units
Power dissipation	75	mW
DC Forward Current	30	mA
Peak Forward Current [1]	160	mA
Reverse Voltage	5	V
Operating / Storage Temperature	-40°C To +85°C	

Note:

1. 1/10 Duty Cycle, 0.1ms Pulse Width.

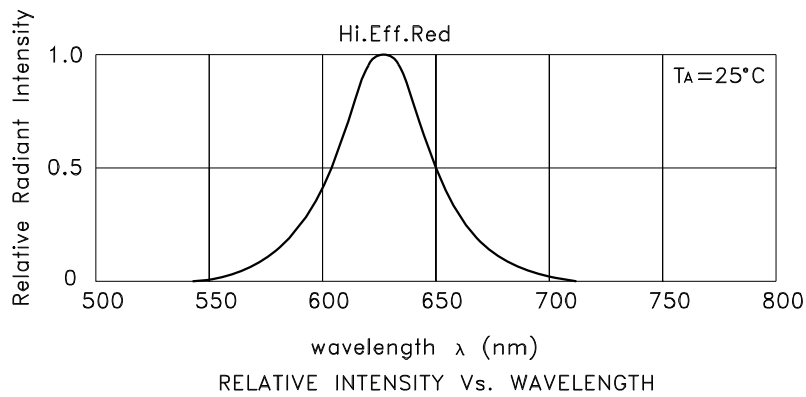

High Efficiency Red KCDA02-101

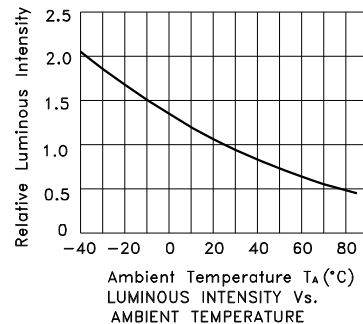
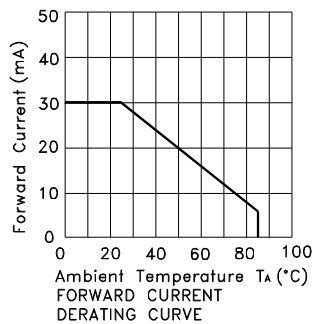
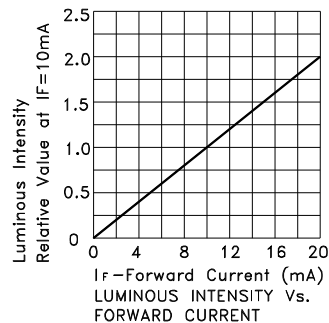
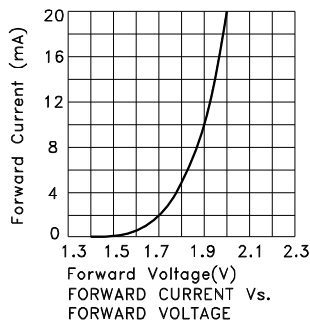

CIRCUIT DESIGN NOTES

1. Protective current-limiting resistors may be necessary to operate the Displays.
2. LEDs mounted in parallel should each be placed in series with its own current-limiting resistor.

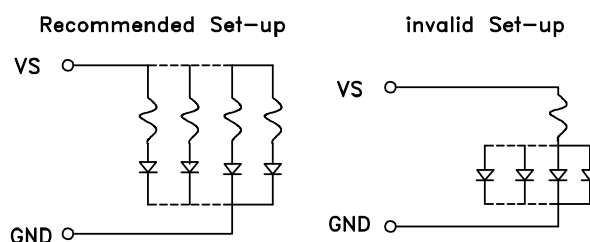

KCDA02-101

Reflow Soldering Profile For Lead-free SMT Process.



NOTES:

1. We recommend the reflow temperature 245°C(+/-5°C). The maximum soldering temperature should be limited to 260°C.
2. Don't cause stress to the epoxy resin while it is exposed to high temperature.
3. Number of reflow process shall be 2 times or less.

Recommended Soldering Pattern (Units : mm; Tolerance: ± 0.15)

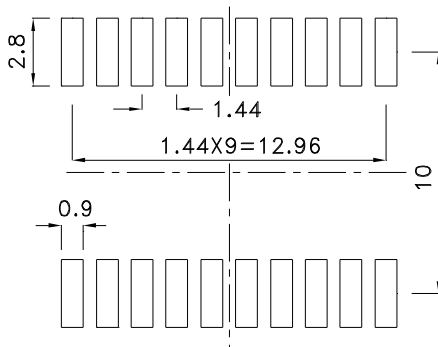

Reel Dimension



Tape Specifications (Units : mm)

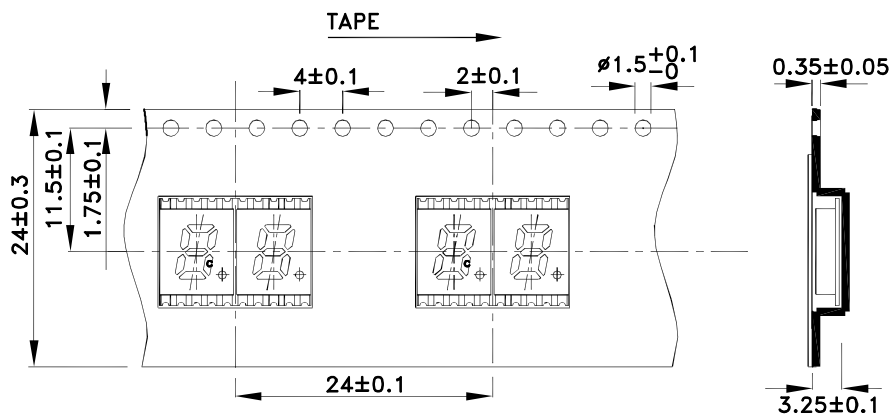

PACKING & LABEL SPECIFICATIONS

KCDA02-101

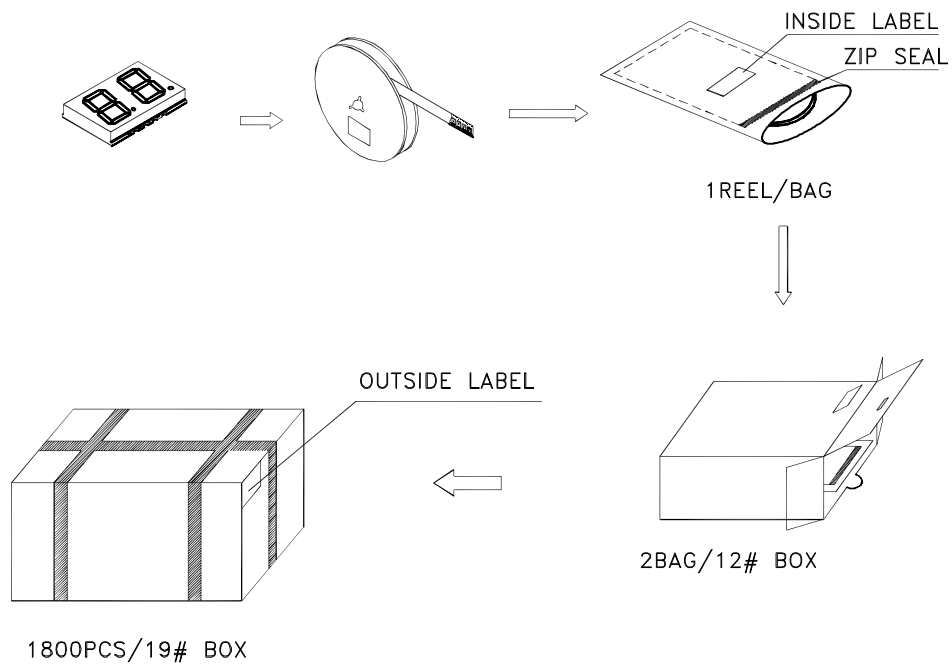

Inside Label On Tape

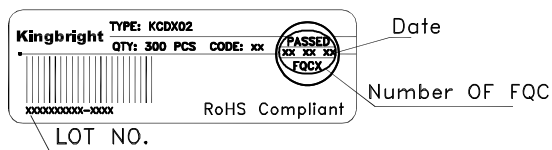

Outside Label On BAG

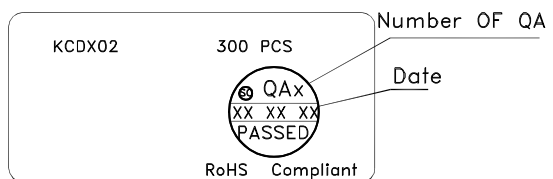

Outside Label On 19#Box

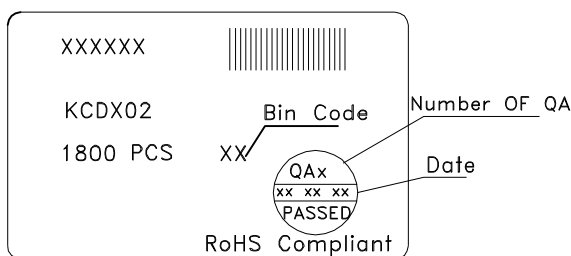

Outside Label On 12#Box

