



Features

- LF to 6000MHz Operation
- Symmetric SP3T
- Low Loss: 0.5dB (2GHz)
- Isolation: 27dB (2GHz)
- High IP3: 56dBm
- P0.1dB: 31dBm (5V, 2.2GHz)
- Positive Logic Control
- 3V and 5V Logic Compatible

Applications

- Cellular, 3G, LTE Infrastructure
- WiBro, WiMAX, LTE
- Wireless Backhaul
- High Performance Communications Systems
- GMSK, QPSK, DQPSK, QAM Modulation

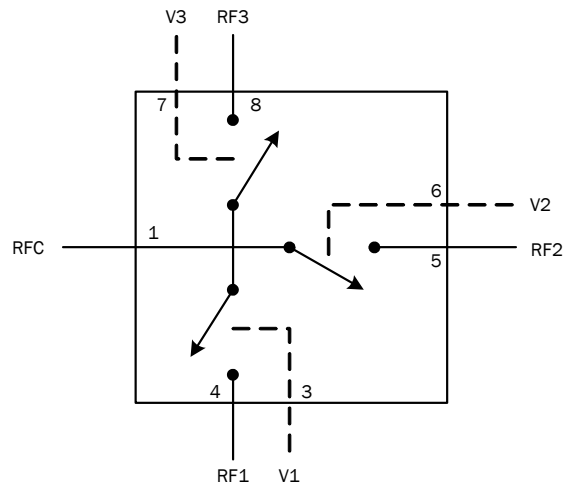

Functional Block Diagram

Product Description

The RFSW6131 is a GaAs pHEMT Single-Pole Three-Throw (SP3T) switch designed for use in Cellular, 3G, LTE, and other high performance communications systems. It offers a symmetric topology with excellent linearity and power handling capability. The RFSW6131 is 3V and 5V positive logic compatible.

Ordering Information

RFSW6131SQ	Sample bag with 25 pieces
RFSW6131SR	7" Sample reel with 100 pieces
RFSW6131TR13	13" Reel with 2500 pieces
RFSW6131PCK-410	0.4GHz to 6GHz PCBA with 5-piece sample bag

Optimum Technology Matching® Applied

- | | | | |
|--------------------------------------|--------------------------------------|--|------------------------------------|
| <input type="checkbox"/> GaAs HBT | <input type="checkbox"/> SiGe BiCMOS | <input checked="" type="checkbox"/> GaAs pHEMT | <input type="checkbox"/> GaN HEMT |
| <input type="checkbox"/> GaAs MESFET | <input type="checkbox"/> Si BiCMOS | <input type="checkbox"/> Si CMOS | <input type="checkbox"/> BiFET HBT |
| <input type="checkbox"/> InGaP HBT | <input type="checkbox"/> SiGe HBT | <input type="checkbox"/> Si BJT | <input type="checkbox"/> LD MOS |

RF MICRO DEVICES®, RFMD®, Optimum Technology Matching®, Enabling Wireless Connectivity™, PowerStar®, POLARIS™ TOTAL RADIO™ and UltimateBlue™ are trademarks of RFMD, LLC. BLUETOOTH is a trademark owned by Bluetooth SIG, Inc., U.S.A. and licensed for use by RFMD. All other trade names, trademarks and registered trademarks are the property of their respective owners. ©2012, RF Micro Devices, Inc.

Absolute Maximum Ratings

Parameter	Rating	Unit
Control Voltage (V1, V2, V3)	7.0	V
Maximum CW Input Power for 3V Control	31	dBm
Maximum CW Input Power for 5V Control	32	dBm
Operating Temperature Range	-40 to +85	°C
Storage Temperature Range	-40 to +150	°C
Maximum Junction Temperature	+150	°C
ESD Rating - Human Body Model (HBM)	Class 0 (100V)	
Moisture Sensitivity Level	MSL3	



Caution! ESD sensitive device.

Exceeding any one or a combination of the Absolute Maximum Rating conditions may cause permanent damage to the device. Extended application of Absolute Maximum Rating conditions to the device may reduce device reliability. Specified typical performance or functional operation of the device under Absolute Maximum Rating conditions is not implied.

The information in this publication is believed to be accurate and reliable. However, no responsibility is assumed by RF Micro Devices, Inc. ("RFMD") for its use, nor for any infringement of patents, or other rights of third parties, resulting from its use. No license is granted by implication or otherwise under any patent or patent rights of RFMD. RFMD reserves the right to change component circuitry, recommended application circuitry and specifications at any time without prior notice.



RFMD Green: RoHS compliant per EU Directive 2002/95/EC, halogen free per IEC 61249-2-21, < 1000ppm each of antimony trioxide in polymeric materials and red phosphorus as a flame retardant, and <2% antimony in solder.

Parameter	Specification			Unit	Condition
	Min.	Typ.	Max.		
General Performance					T = 25 °C, 100pF EVB DC Blocks. 3V unless otherwise noted.
Insertion Loss (RFC to RF1/RF2/RF3)		0.45		dB	1GHz
		0.50	0.70	dB	2GHz
		0.60		dB	4GHz
		0.65		dB	5.85GHz
Isolation (RFC to RF1/RF2/RF3)		31		dB	1GHz
	25	27		dB	2GHz
		24		dB	4GHz
		24		dB	5.85GHz
Isolation (RF1-RF2, RF1-RF3, RF2-RF3)		32		dB	1GHz
		27		dB	2GHz
		25		dB	4GHz
		25		dB	5.85GHz
Return Loss (On State)		>20		dB	1GHz
		>20		dB	2GHz
		>20		dB	4GHz
		>20		dB	5.85GHz
IPO.1dB		27		dBm	3.0V, 2.2GHz
		31		dBm	5.0V, 2.2GHz
IIP3		56		dBm	17 dBm input power/tone, 1MHz spacing, 3V
T _{ON} , T _{OFF}		25		ns	50% V _{CC} to 10/90% RF, +10dBm input power
T _{RISE} , T _{FALL}		20		ns	10/90% RF, +10dBm input power
Power Supply					
"High" Control Voltage	1.8		5.0	V	Logic "high"
"Low" Control Voltage	0		0.2	V	Logic "low"
Control Current		0.7	2.5	µA	5V
Notes: User should optimize DC-blocking capacitors for the desired frequency of operation. For positive logic control, DC-blocking capacitors are required on all RF ports.					

Typical Performance: 0.4GHz to 6.0GHz Evaluation Board
 (3V unless otherwise noted, THRU losses deembedded)

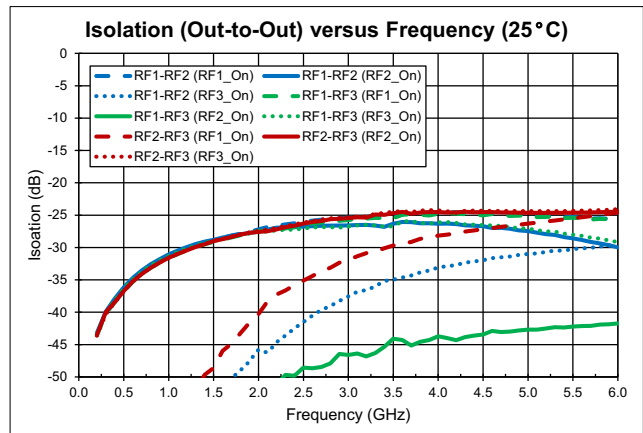
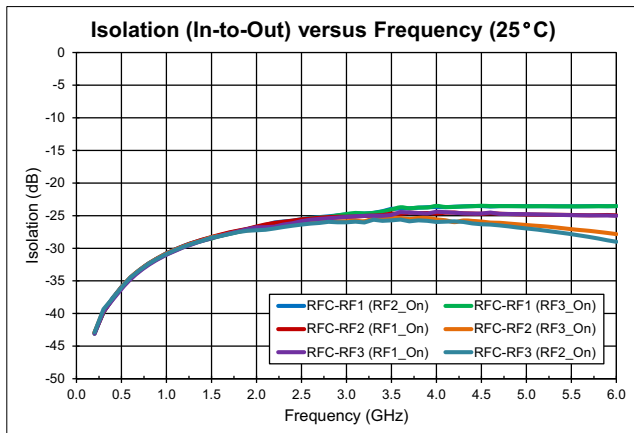
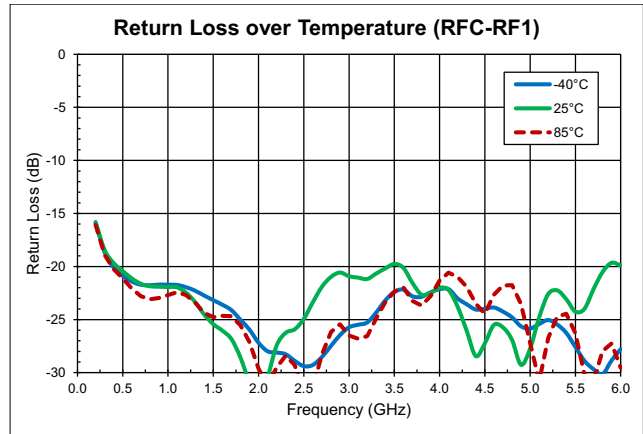
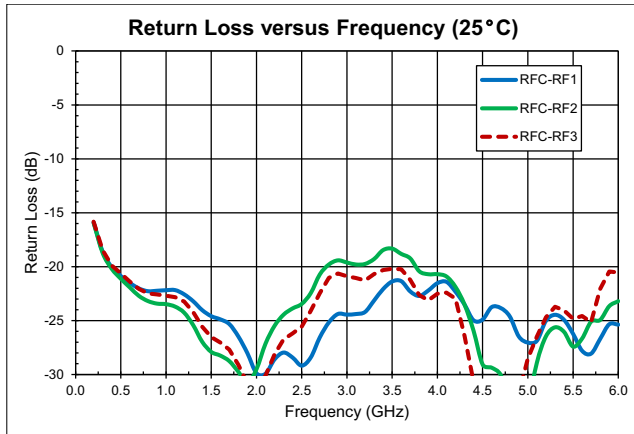
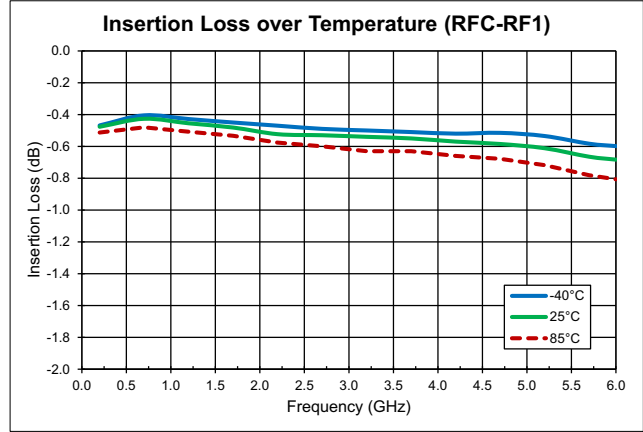
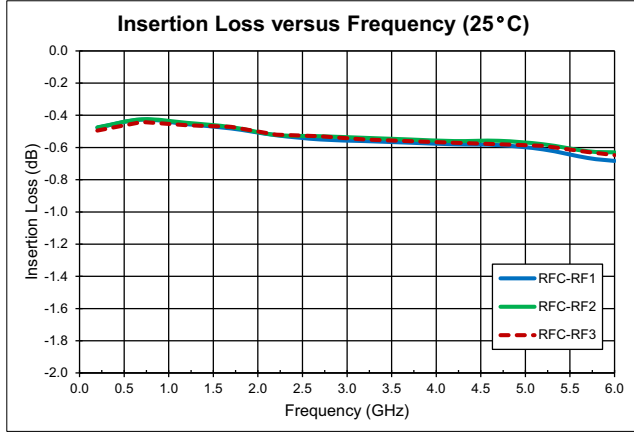

Typical Performance: 0.4GHz to 6.0GHz Evaluation Board (3V unless otherwise noted, THRU losses deembedded)

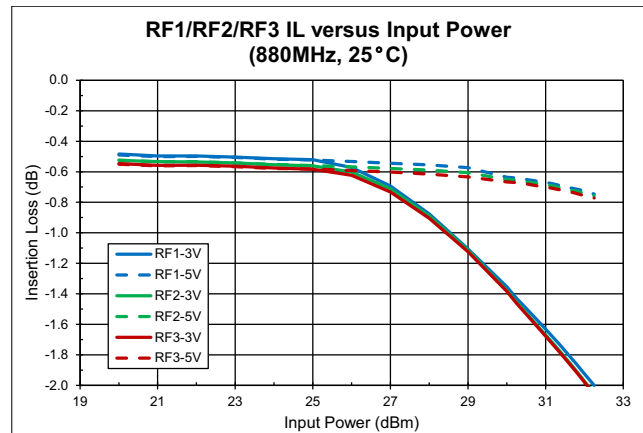
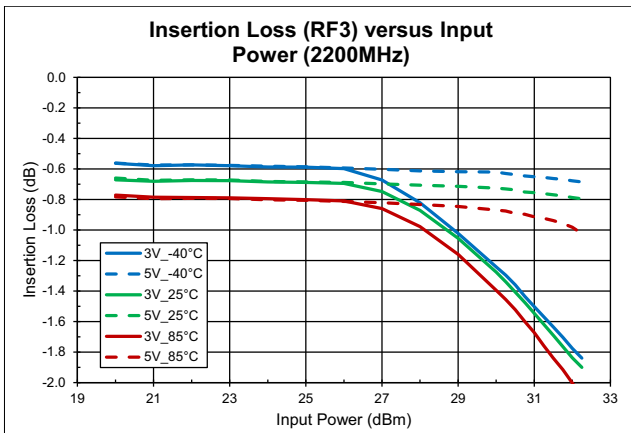
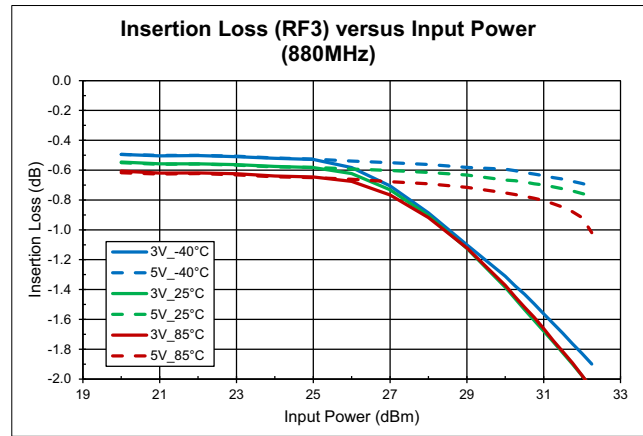
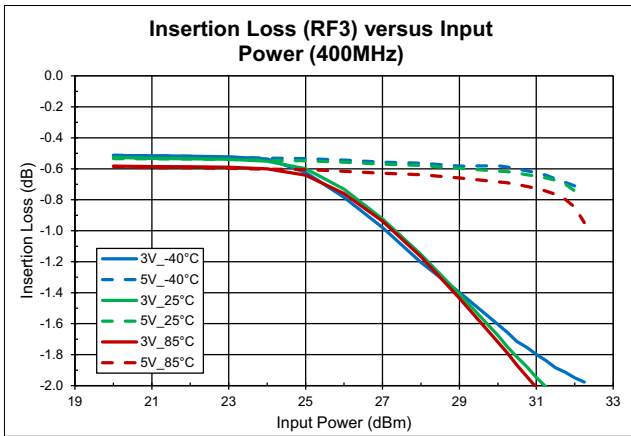
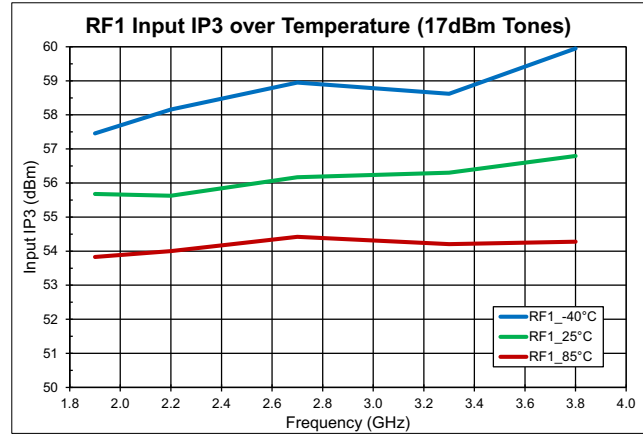
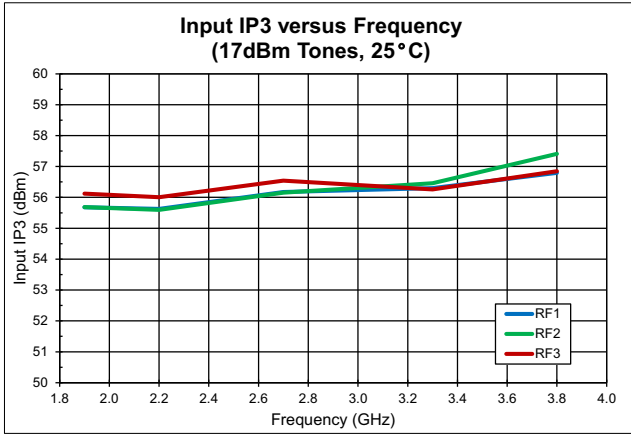

THRU Evaluation Board



NOTE: The SW6131 Sample EVB is symmetric - each RF port has the same length of transmission line between the SMA connector and the DUT. The SMA connector and transmission line losses from RFC to RF1/RF2/RF3 have been characterized using the Test Coupon above with 100pF capacitors. The THRU line losses are dependent on the value of the DC blocks so the user should optimize the cap value for the actual band of operation.

THRU Loss Chart

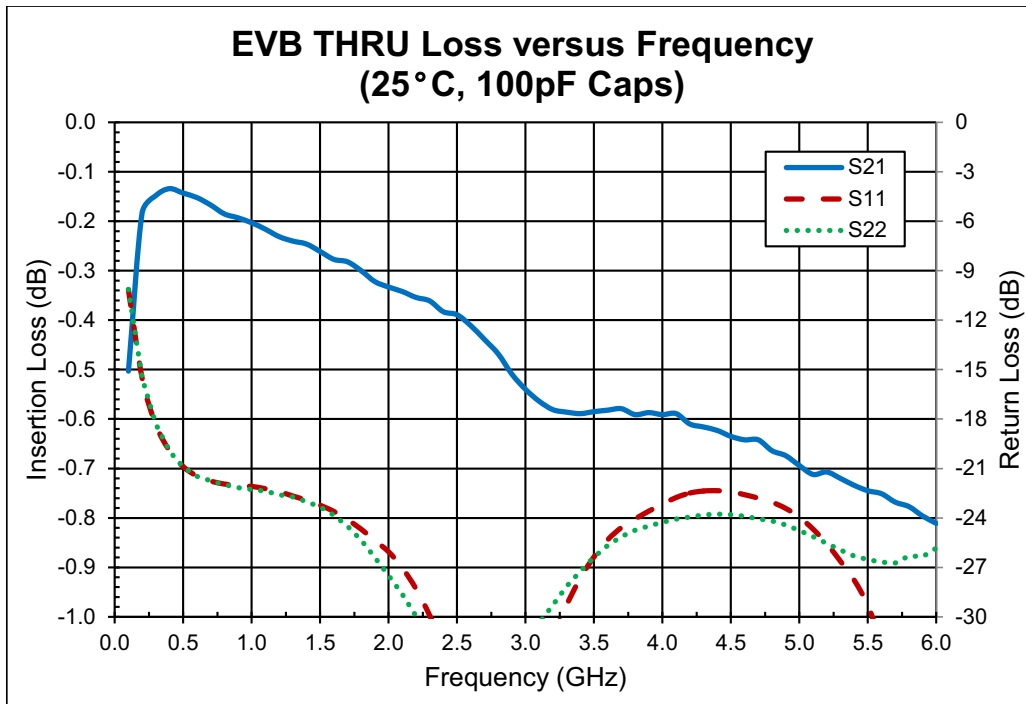

Evaluation Board Schematic

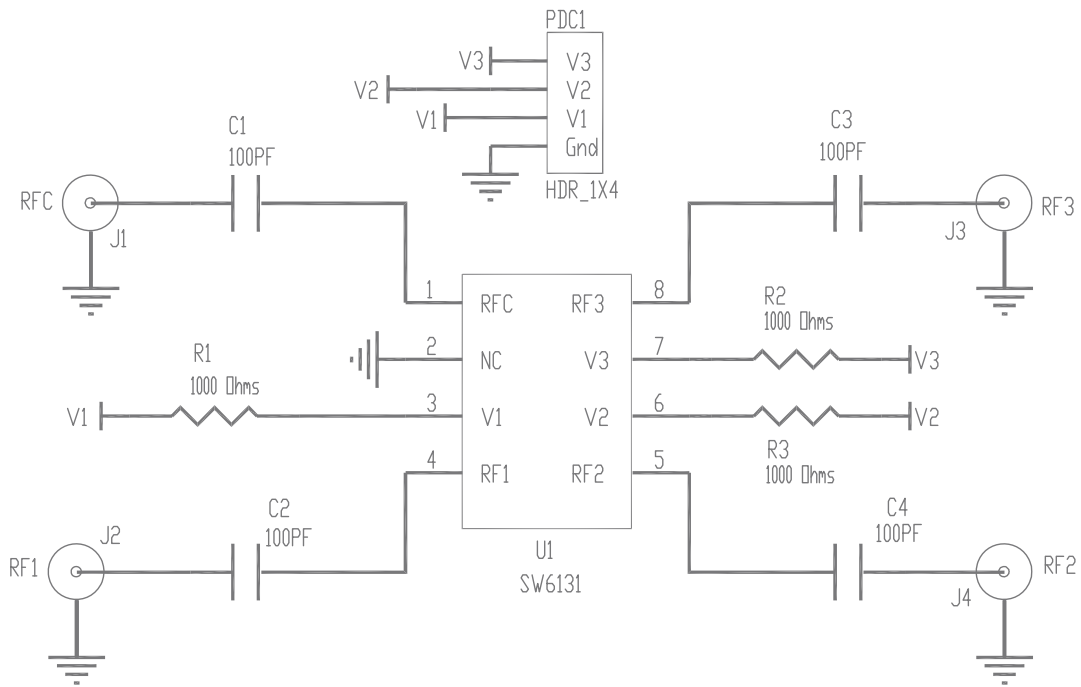

Evaluation Board Assembly Drawing

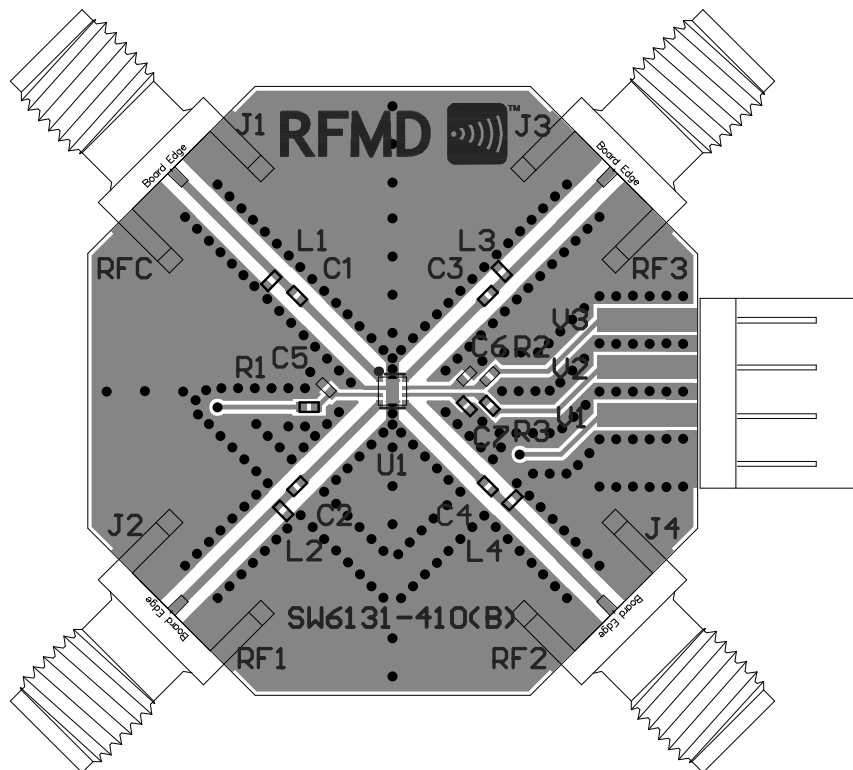

Evaluation Board Bill of Materials (BOM)

Description	Reference Designator	Manufacturer	Manufacturer's P/N
SW6131 Evaluation Board			SW6131-410(B)
RFSW6131, SP3T Switch	U1	RFMD	RFSW6131
CAP, 100pF, 5%, 50V, COG, 0402	C1-C4	Murata Electronics	GRM1555C1H101JD01E
RES, 1K, 5%, 1/16W, 0402	R1-R3	Kamaya Inc.	RMC1/16S-102JTH
CONN, SMA, END LAUNCH, 26.5GHZ, 0.068	J1-J4	Gigalane	PSF-S01-008
CONN, HDR, ST, PLRZD, 4-PIN, 0.100"	PDC1	ITW Pancon	MPSS100-4-C
DO NOT PLACE	C5-C7, L1-L4		

Pin Names and Description

Pin	Function	Description
1	RFC	RF common port - external DC block required
2	NC	No internal connection
3	V1	Control 1
4	RF1	RF Port 1 - external DC block required
5	RF2	RF Port 2 - external DC block required
6	V2	Control 2
7	V3	Control 3
8	RF3	RF Port 3 - external DC block required
EPAD	GND	RF and DC Ground. Must be soldered to EVB ground plane over a bed of vias.

Note: RFMD recommends that the NC pins be grounded on the EVB to maximize isolation.

Truth Table

Control Logic			RF Path Configuration		
V1	V2	V3	RFC-RF1	RFC-RF2	RFC-RF3
1	0	0	On	Off	Off
0	1	0	Off	On	Off
0	0	1	Off	Off	On
1 = 1.8V to 5.0V 0 = 0V to 0.2V					

Package Pinout

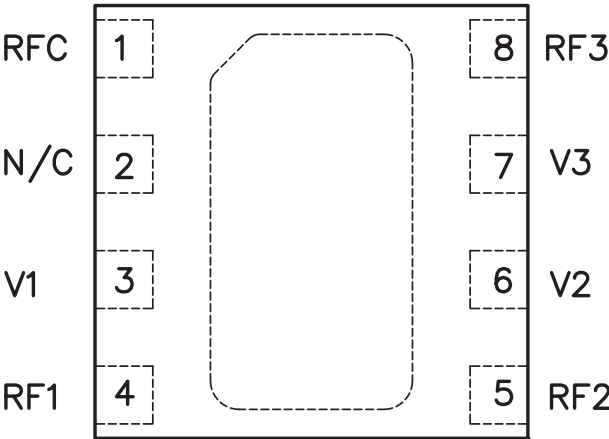

Package Outline and Branding Drawing

(Dimensions in millimeters)

