

Total solder points: 62

Difficulty level: *beginner* 1 2 3 4 5 *advanced*

1W / 3W POWER LED DRIVER



K8071

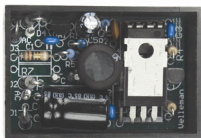

Power up to four 1W or two 3W
high-power LEDs.



VELLEMAN NV
Legen Heirweg 33
9890 Gavere
Belgium Europe
www.velleman.be
www.velleman-kit.com

Features:

- ☑ delivers accurate constant current required by most high-power LEDs
- ☑ high efficiency due to switch mode principle
- ☑ built-in rectifier for easy connection to AC source
- ☑ compact size
- ☑ short-circuit protected
- ☑ no heatsink required
- ☑ also suited as fixed current NiCd/NiMH battery charge circuit
- ☑ for home, disco, stage, education, architectural lighting, science projects, ...

Specifications:

- 350mA or 700mA constant current source
- input voltage: 6..12VAC / 9-18VDC
- power consumption: 650mA max.
- dimensions: 45x30x16mm / 1.8x1.2x0.64"

1. Assembly (Skipping this can lead to troubles !)

Ok, so we have your attention. These hints will help you to make this project successful. Read them carefully.

1.1 Make sure you have the right tools:

- A good quality soldering iron (25-40W) with a small tip.
- Wipe it often on a wet sponge or cloth, to keep it clean; then apply solder to the tip, to give it a wet look. This is called 'thinning' and will protect the tip, and enables you to make good connections. When solder rolls off the tip, it needs cleaning.
- Thin raisin-core solder. Do not use any flux or grease.
- A diagonal cutter to trim excess wires. To avoid injury when cutting excess leads, hold the lead so they cannot fly towards the eyes.
- Needle nose pliers, for bending leads, or to hold components in place.
- Small blade and Phillips screwdrivers. A basic range is fine.

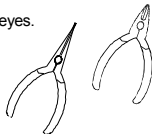

For some projects, a basic multi-meter is required, or might be handy

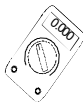

1.2 Assembly Hints :

- ⇒ Make sure the skill level matches your experience, to avoid disappointments.
- ⇒ Follow the instructions carefully. Read and understand the entire step before you perform each operation.
- ⇒ Perform the assembly in the correct order as stated in this manual
- ⇒ Position all parts on the PCB (Printed Circuit Board) as shown on the drawings.
- ⇒ Values on the circuit diagram are subject to changes, the values in this assembly guide are correct*
- ⇒ Use the check-boxes to mark your progress.
- ⇒ Please read the included information on safety and customer service

* Typographical inaccuracies excluded. Always look for possible last minute manual updates, indicated as 'NOTE' on a separate leaflet.

1.3 Soldering Hints :

1- Mount the component against the PCB surface and carefully solder the leads

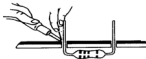

2- Make sure the solder joints are cone-shaped and shiny



3- Trim excess leads as close as possible to the solder joint



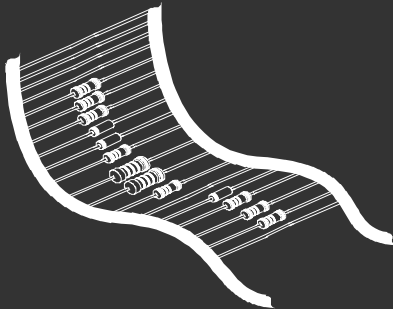

REMOVE THEM FROM THE TAPE ONE AT A TIME !

Included in
this kit

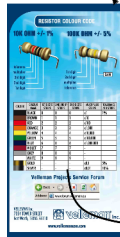

2. RESISTOR

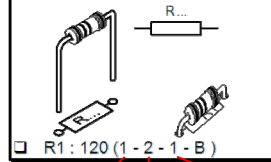

COLOUR	COLOUR NAME	1ST DIGIT/ STRIPE	2ND DIGIT/ STRIPE	3RD DIGIT/ STRIPE	MULTIPLIER STRIPE	TOLE 4TH!
	BLACK	0	0	0	x1	1%
	BROWN	1	1	1	x10	
	RED	2	2	2	x100	
	ORANGE	3	3	3	x1.000	
	YELLOW	4	4	4	x10.000	
	GREEN	5	5	5	x100.000	
	BLUE	6	6	6	x1.000.000	

**DO NOT BLINDLY FOLLOW THE ORDER OF THE COMPONENTS ONTO THE TAPE.
ALWAYS CHECK THEIR VALUE ON THE PARTS LIST!**

1. Metal film resistors

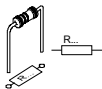

- R6 : 1 (1-0-B-B-9)

If 700mA output is desired, mount R7 :

- R7 : 1 (1-0-B-B-9)

2. Schottky diode. Watch the polarity!

- D5 : SB130

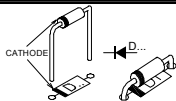

3. IC sockets, Watch the position of the notch!

- IC1 : 8P

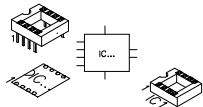

4. Capacitors.

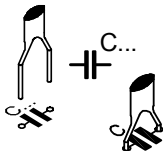

- C1 : 100nF (104)
 C2 : 100nF (104)
 C3 : 100nF (104)
 C4 : 68pF (68)

5. Vertical metal film resistors

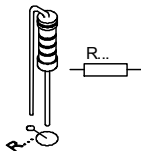

- R1 : 30K (3-0-0-2-1)
 R2 : 2K2 (2-2-0-1-1)
 R5 : 2K2 (2-2-0-1-1)

6. Vertical resistors

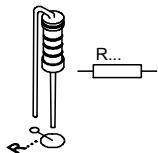

- R3 : 100 (1-0-1-B)
 R4 : 1K (1-0-2-B)

7. Transistors.

- T2 : BC547B
 T3 : BC557B

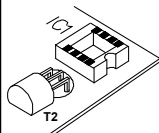
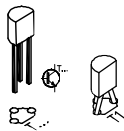

Bend transistor T2 away from IC socket IC1.

8. Voltage regulator

- ☐ VR1 : UA78L05

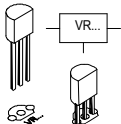

9. Diodes. Watch the polarity!

- ☐ D1 : 1N4007
- ☐ D2 : 1N4007
- ☐ D3 : 1N4007
- ☐ D4 : 1N4007

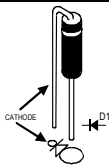

10. PCB tabs

- ☐ AC (2x)
- ☐ - (C)
- ☐ + (A)

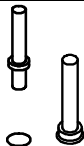

11. Electrolytic Capacitor. Watch the polarity !

- ☐ C5 : 10µF/35V

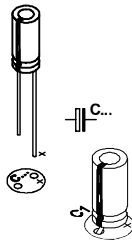

- ☐ C6 : 470µF/25V

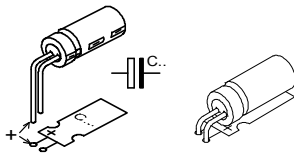

☞ Bend the electrolytic capacitor away from diode D1.

12. Coil

- ☐ L1 : 330µH / 1A

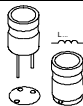

13 IC. Watch the position of the notch!

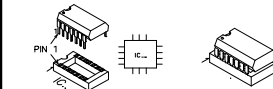

- ☐ IC1 : LM393

14. Power Mosfet T1

- ☐ T1 : IRF9520

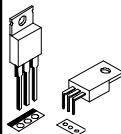

☞ Bend the power mosfet toward IC1



15. Connection

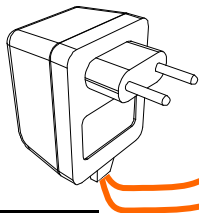

6 - 14VAC
or
9 - 18VDC

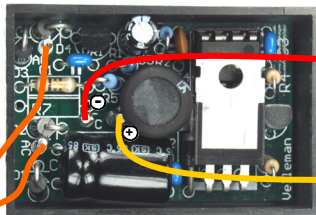

Maximum 2 x 3W power LED

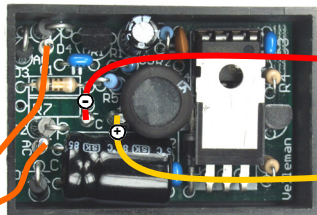
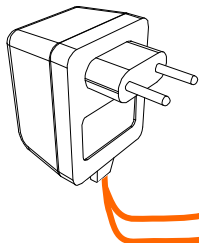
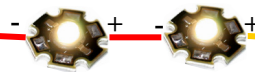

Maximum 4 x 1W power LED



16. Schematic diagram.

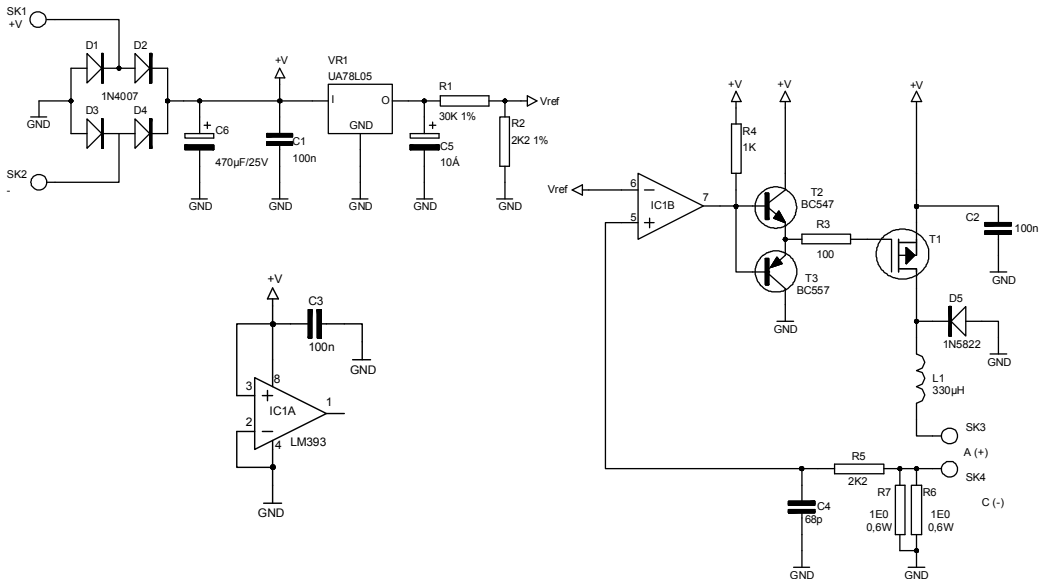

17. PCB

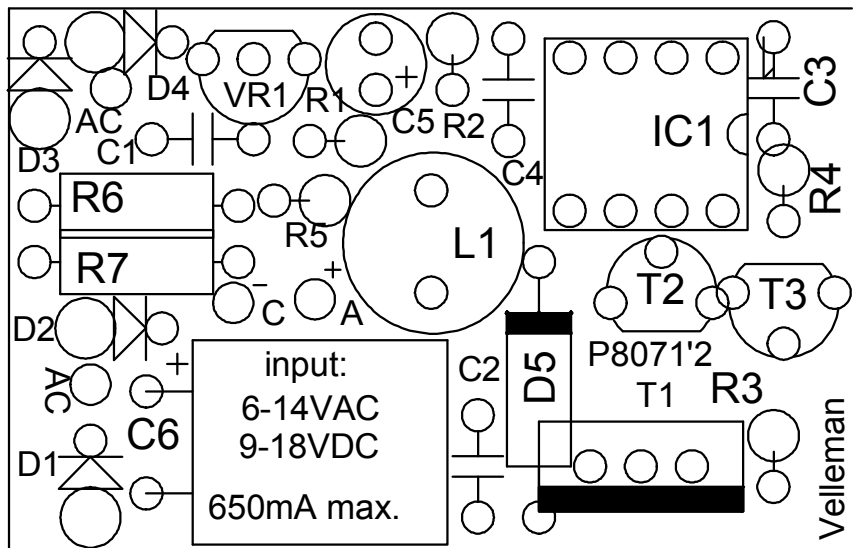

EDU 01**SOLDERLESS EDUCATIVE STARTERBOX**

The EDU01 basic experiment kit is the first step into the world of modern electronics. Build your own circuits in a fun, safe and educative way.

AVAILABLE**EDU 02****SOLAR ENERGY EXPERIMENT KIT**

Fun solar powered projects. Learn all about solar energy.

AVAILABLE**EDU 03****SOLDER EDUCATIVE STARTER BOX**

Learn how to solder, build different exciting projects. Includes spare components and demo boards.

COMING SOON**EDU 04****PIC™ TUTOR KIT**

Enter the world of microcontroller programming, easy step by step instructions. Includes programmer and test board.

The Microchip name and logo, PIC, and PICmicro are registered trademarks of Microchip Technology Inc. in the USA and other countries.

COMING SOON**EDU 05****USB TUTOR BOARD**

Learn how to connect your computer with the outside world, master the USB communication with tutorial examples. Play with LED indicators and learn how to drive LCD displays.

COMING SOON**EDU 06****SCOPE EDUKIT**

This board with different signals will teach you how to use an oscilloscope. Optimized instructions for use of our HPS140 oscilloscope. YouTube demo movies.

COMING SOON