

# Voltage monitoring relays CM-ESS.2

## For single-phase AC/DC voltages

The CM-ESS.2 is an electronic voltage monitoring relay that provides reliable monitoring of voltages as well as detection of phase loss.

All devices are available with two different terminal versions. You can choose between the proven screw connection technology (double-chamber cage connection terminals) and the completely tool-free Easy Connect Technology (Push-in terminals).

### Characteristics

- Monitoring of DC and AC voltages (3-600 V)
- TRMS measuring principle
- One device includes 4 measuring ranges
- Over- or undervoltage monitoring configurable
- Hysteresis adjustable (3-30 %)
- Tripping delay  $T_V$  adjustable (0 s; 0.1-30 s)
- 3 control supply voltage versions
- Precise adjustment by front-face operating controls
- Screw connection technology or Easy Connect Technology available
- Housing material for highest fire protection classification UL 94 V-0
- Tool-free mounting on DIN rail as well as demounting
- 2 c/o (SPDT) contacts
- 22.5 mm (0.89 in) width
- 3 LEDs for status indication

### Order data

#### Voltage monitoring relays

Type	Rated control supply voltage	Connection technology	Measuring ranges	Order code
CM-ESS.2P	24-240 V AC/DC	Push-in terminals	3-30 V, 6-60 V, 30-300 V, 60-600 V	1SVR 740 830 R0400
	110-130 V AC			1SVR 740 831 R0400
	220-240 V AC			1SVR 740 831 R1400
CM-ESS.2S	24-240 V AC/DC	Screw type terminals	3-30 V, 6-60 V, 30-300 V, 60-600 V	1SVR 730 830 R0400
	110-130 V AC			1SVR 730 831 R0400
	220-240 V AC			1SVR 730 831 R1400

#### Accessories

Type	Description	Order code
ADP.01	Adapter for screw mounting	1SVR 430 029 R0100
MAR.12	Marker label for devices with DIP switches	1SVR 730 006 R0000
COV.11	Sealable transparent cover	1SVR 730 005 R0100

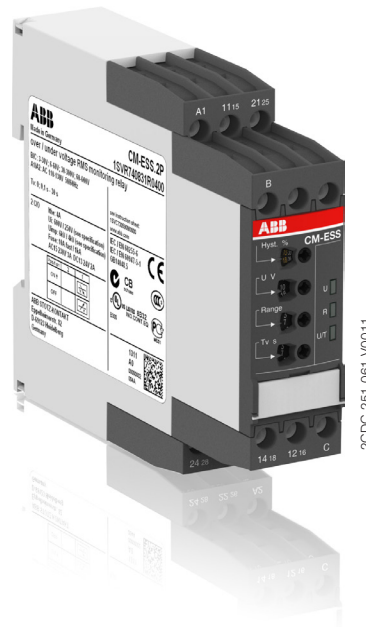

### Approvals

UL 508, CAN/CSA C22.2 No.14

GL

(pending)

GOST

CB Scheme

CCC

RMRS

### Marks

CE

C-Tick

## Connection technology

### Maintenance free Easy Connect Technology with Push-in terminals

Type designation CM-xxS.yyP

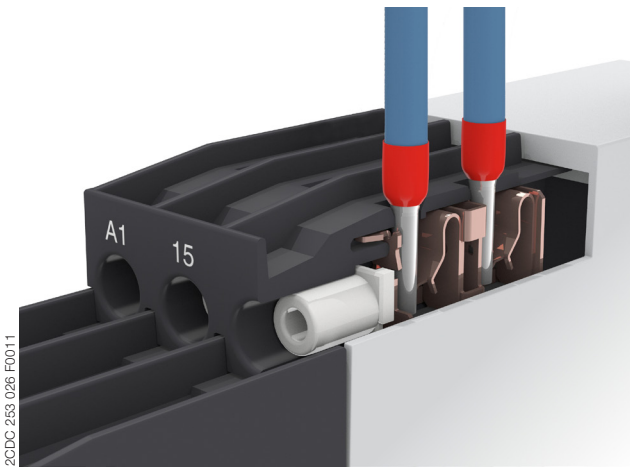

#### Push-in terminals

- Tool-free connection of rigid and flexible wires with wire end ferrule according to DIN 46228-1-A, DIN 46228-4-E  
Wire size: 2 x 0.5-1.5 mm<sup>2</sup>, (2 x 20 - 16 AWG)
- Easy connection of flexible wires without wire end ferrule by opening the terminals
- No retightening necessary
- One operation lever for opening both connection terminals
- For triggering the lever and disconnecting of wires you can use the same tool (Screwdriver according to DIN ISO 2380-1 Form A 0.8 x 4 mm (0.0315 x 0.157 in), DIN ISO 8764-1 PZ1 ø 4.5 mm (0.177 in))
- Constant spring force on terminal point independent of the applied wire type, wire size or ambient conditions (e. g. vibrations or temperature changes)
- Opening for testing the electrical contacting
- Gas-tight

### Approved screw connection technology with double-chamber cage connection terminals

Type designation CM-xxS.yyS

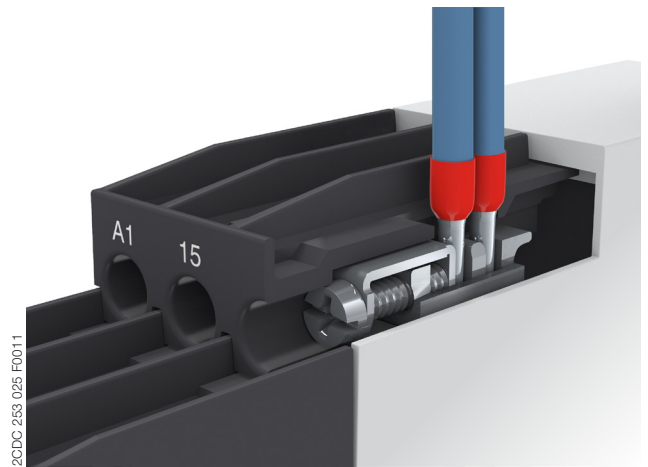

#### Double-chamber cage connection terminals

- Terminal spaces for different wire sizes:  
fine-strand with/without wire end ferrule:  
1 x 0.5-2.5 mm<sup>2</sup> (2 x 20 - 14 AWG),  
2 x 0.5-1.5 mm<sup>2</sup> (2 x 20 - 16 AWG)  
rigid:  
1 x 0.5-4 mm<sup>2</sup> (1 x 20 - 12 AWG),  
2 x 0.5-2.5 mm<sup>2</sup> (2 x 20 - 14 AWG)
- One screw for opening and closing of both cages
- Pozidrive screws for pan- or crosshead screwdrivers according to DIN ISO 2380-1 Form A 0.8 x 4 mm (0.0315 x 0.157 in), DIN ISO 8764-1 PZ1 ø 4.5 mm (0.177 in)

Both the Easy Connect Technology with Push-in terminals and screw connection technology with double-chamber cage connection terminals have the same connection geometry as well as terminal position.

## Functions

### Operating controls

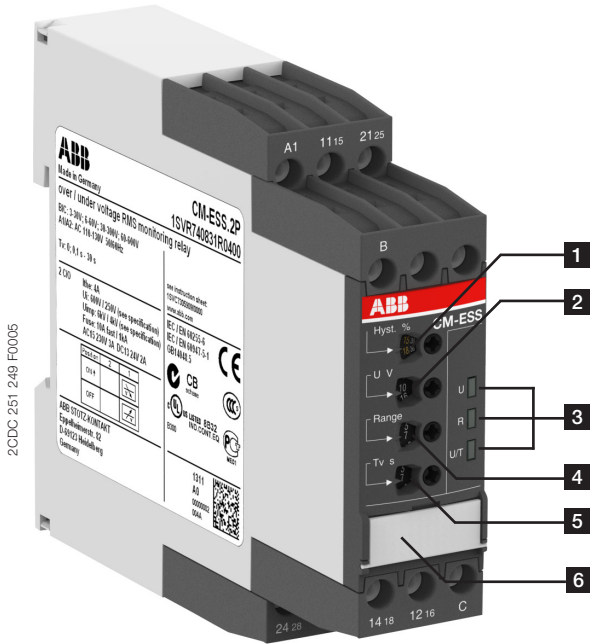

**1** Adjustment of the hysteresis

**2** Adjustment of the threshold value

**3** Indication of operational states

U/T: green LED – control supply voltage/timing

R: yellow LED – relay status

U: red LED – over- / undervoltage

**4** Adjustment of the measuring range

**5** Adjustment of the tripping delay  $T_V$

**6** DIP switches (see DIP switch functions)



When compared with our previous version, the position of the adjustment potentiometers 4 and 5 have changed places.

### Application

The voltage monitoring relays CM-ESS.2 are designed for use in single-phase AC and/or DC systems for over- or undervoltage monitoring as well as detection of phase loss. The devices are available with different supply voltage ranges, provide an adjustable tripping delay and work according to the open-circuit principle.

### Operating mode

The CM-ESS.2 have 2 c/o (SPDT) contacts and include 4 measuring ranges: 3-30 V, 6-60 V, 30-300 V and 60-600 V.

The units are adjusted with front-face operating controls. The selection of over-  or undervoltage monitoring  is made with a DIP switch. Potentiometers, with direct reading scale, allow the adjustment of the threshold value U, the hysteresis % and the tripping delay  $T_V$ . The hysteresis % is adjustable within a range of 3 to 30 % of the threshold value and the tripping delay  $T_V$  over a range of instantaneous to a 30 s delay. Timing is displayed by a flashing green LED labelled U/T.

## Function diagrams

### Overvoltage monitoring

The voltage to be monitored (measured value) is applied to terminals B-C. The control supply voltage applied to terminals A1-A2 is displayed by the glowing green LED.

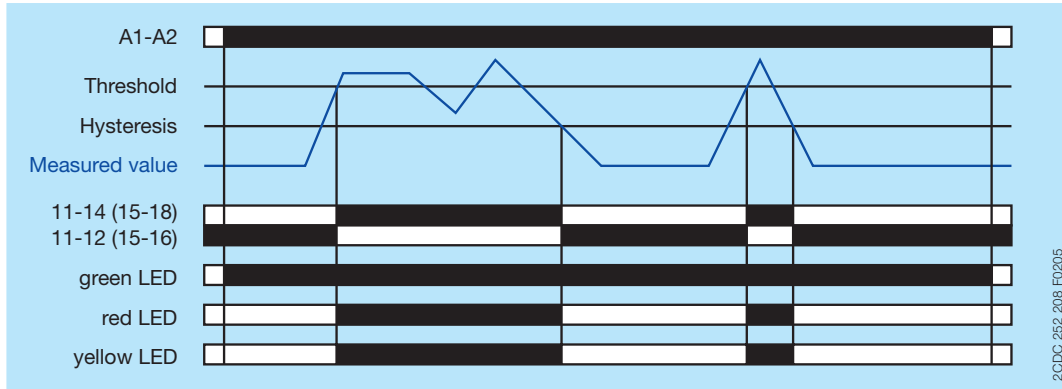

If the measured value exceeds the adjusted threshold value, the tripping delay  $T_V$  starts and the red LED (overvoltage) glows. Timing of  $T_V$  is displayed by the flashing  green LED. When  $T_V$  is complete and the measured value still exceeds the threshold value minus the adjusted hysteresis, the output relays energize and the yellow LED (relay energized) glows.

If the measured value drops below the threshold value minus the adjusted hysteresis, the output relays de-energize and the red and yellow LEDs turn off. If control supply voltage is interrupted, the green LED turns off.



### Undervoltage monitoring

The voltage to be monitored (measured value) is applied to terminals B-C. The control supply voltage applied to terminals A1-A2 is displayed by the glowing green LED.

If the measured value decreases below the adjusted threshold value, the tripping delay  $T_V$  starts and the red LED (undervoltage) flashes . Timing of  $T_V$  is displayed by the flashing  green LED. When  $T_V$  is complete and the measured value is still below the threshold value plus the adjusted hysteresis, the output relays energize and the yellow LED (relay energized) glows.

If the measured value exceeds the threshold value plus the adjusted hysteresis, the output relays de-energize and the red and yellow LEDs turn off.

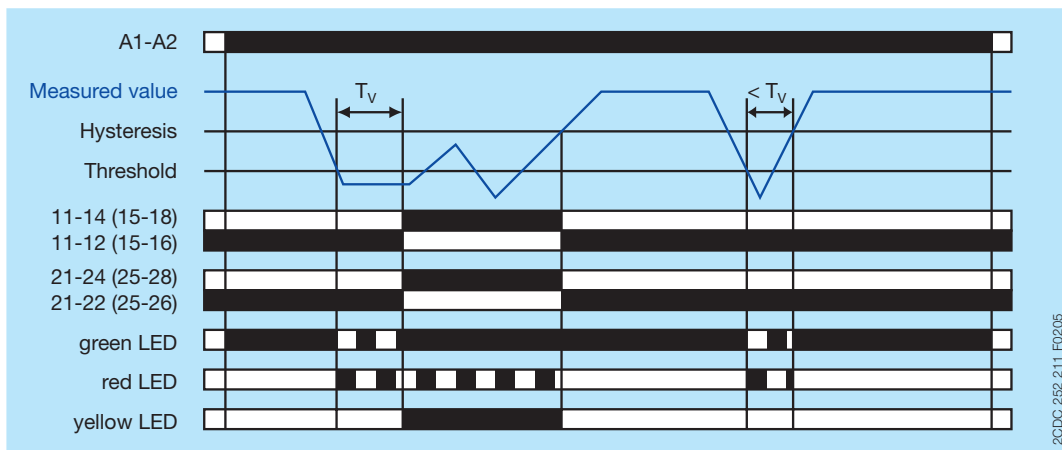

## Electrical connection

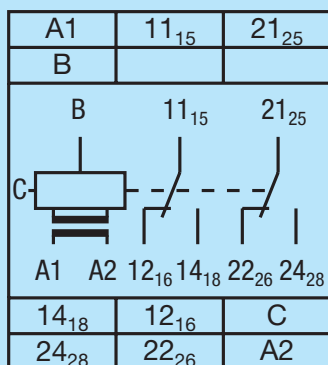

2C0C 252 207 F0005

A1-A2      Rated control supply voltage  
 B-C        Measuring ranges: 3-30 V, 6-60 V, 30-300 V, 60-600 V  
 11<sub>15</sub>-12<sub>16</sub>/14<sub>18</sub>    Output contacts - open-circuit principle  
 21<sub>25</sub>-22<sub>26</sub>/24<sub>28</sub>

Connection diagram

## DIP switches

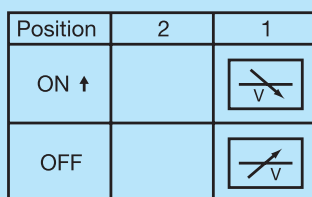

2C0C 252 2715 F0005

1    ON      Undervoltage monitoring  
       OFF      Overvoltage monitoring  
 OFF = Default





## Technical data

Data at  $T_a = 25\text{ °C}$  and rated values, unless otherwise indicated

### Input circuits

Supply circuit		A1-A2		
Rated control supply voltage $U_s$		110-130 V AC	220-240 V AC	24-240 V AC/DC
Rated control supply voltage $U_s$ tolerance		-15...+10 %		
Rated frequency		50/60 Hz		50/60 Hz or DC
Typical current / power consumption	24 V DC	-	-	30 mA / 0.75 W
	115 V AC	24 mA / 2.6 VA	-	17 mA / 1.9 VA
	230 V AC	-	12 mA / 2.6 VA	11 mA / 2.6 VA
Power failure buffering time		20 ms		
Transient overvoltage protection		varistors		
Measuring circuit		B-C		
Monitoring function		over- or undervoltage monitoring configurable		
Measuring method		TRMS measuring principle		
Measuring inputs	terminal connection	B-C		
	measuring range	3-30 V, 6-60 V, 30-300 V, 60-600 V		
	input resistance	600 k $\Omega$		
	pulse overload capacity $t < 1\text{ s}$	800 V		
	continuous capacity	660 V		
Threshold value		adjustable within the indicated measuring range		
Tolerance of the adjusted threshold value		10 % of the range end value		
Hysteresis related to the threshold value		3-30 % adjustable		
Measuring signal frequency range		DC / 15 Hz - 2 kHz		
Rated measuring signal frequency range		DC / 50-60 Hz		
Maximum response time	AC	80 ms		
	DC	120 ms		
Accuracy within the rated control supply voltage tolerance		$\Delta U \leq 0.5\%$		
Accuracy within the temperature range		$\Delta U \leq 0.06\% / \text{°C}$		
Transient overvoltage protection		varistors		
Timing circuit				
Time delay $T_V$		0 s or 0.1-30 s adjustable		
Repeat accuracy (constant parameters)		$\pm 0.07\%$ of full scale		
Tolerance of the adjusted time delay		-		
Accuracy within the rated control supply voltage tolerance		$\Delta t \leq 0.5\%$		
Accuracy within the temperature range		$\Delta t \leq 0.06\% / \text{°C}$		

### User interface

Indication of operational states		
Control supply voltage	U/T: green LED	 : control supply voltage applied  : tripping delay $T_V$ active
Measured value	U: red LED	 : overvoltage  : undervoltage
Relay status	R: yellow LED	 : output relay energized

## Output circuits

Kind of output	11-12/14	relay, 1st c/o (SPDT) contact
	21-22/24	relay, 2nd c/o (SPDT) contact
Operating principle	open-circuit principle (output relay energizes if the measured value exceeds $\boxed{\nearrow}$ / falls below $\boxed{\searrow}$ the adjusted threshold value)	
Contact material	AgNi	
Rated operational voltage $U_e$ (VDE 0110, IEC/EN 60947-1)	250 V	
Minimum switching voltage / Minimum switching current	24 V / 10 mA	
Maximum switching voltage / Maximum switching current	250 V AC / 4 A AC	
Rated operational current $I_e$ (IEC/EN 60947-5-1)	AC12 (resistive) at 230 V	4 A
	AC15 (inductive) at 230 V	3 A
	DC12 (resistive) at 24 V	4 A
	DC13 (inductive) at 24 V	2 A
AC rating (UL 508)	utilization category (Control Circuit Rating Code)	B 300
	max. rated operational voltage	300 V AC
	max. continuous thermal current at B 300	5 A
	max. making/breaking apparent power at B 300	3600/360 VA
Mechanical lifetime	30 x 10 <sup>6</sup> switching cycles	
Electrical lifetime	AC12, 230 V, 4 A	0.1 x 10 <sup>6</sup> switching cycles
Maximum fuse rating to achieve short-circuit protection	n/c contact	10 A fast-acting
	n/o contact	10 A fast-acting

## General data

MTBF	on request			
Duty time	100 %			
Dimensions (W x H x D)	product dimensions	22.5 x 85.6 x 103.7 mm (0.89 x 3.37 x 4.08 in)		
	packaging dimensions	97 x 109 x 30 mm (3.82 x 4.29 x 1.18 in)		
Weight	Net weight	Version 24-240 V AC/DC	<b>Screw connection technology</b> 0.153 kg (0.337 lb)	<b>Easy Connect Technology (Push-in)</b> 0.142 kg (0.313 lb)
		Version 110-130 V AC	0.181 kg (0.399 lb)	0.170 kg (0.375 lb)
		Version 220-240 V AC	0.181 kg (0.399 lb)	0.170 kg (0.375 lb)
	Gross weight	Version 24-240 V AC/DC	0.176 kg (0.388 lb)	0.164 kg (0.361 lb)
		Version 110-130 V AC	0.204 kg (0.450 lb)	0.193 kg (0.425 lb)
		Version 220-240 V AC	0.176 kg (0.388 lb)	0.165 kg (0.364 lb)
Mounting	DIN rail (IEC/EN 60715), snap-on mounting without any tool			
Mounting position	any			
Material of housing	UL 94 V-0			
Degree of protection	housing	IP50		
	terminals	IP20		

## Electrical connection

		Screw connection technology	Easy Connect Technology (Push-in)
Wire size	fine-strand with(out) wire end ferrule	1 x 0.5-2.5 mm <sup>2</sup> (1 x 20-14 AWG) 2 x 0.5-1.5 mm <sup>2</sup> (2 x 20-16 AWG)	2 x 0.5-1.5 mm <sup>2</sup> (2 x 20-16 AWG)
	rigid	1 x 0.5-4 mm <sup>2</sup> (1 x 20-12 AWG) 2 x 0.5-2.5 mm <sup>2</sup> (2 x 20-14 AWG)	2 x 0.5-1.5 mm <sup>2</sup> (2 x 20-16 AWG)
Stripping length		8 mm (0.32 in)	
Tightening torque		0.6 - 0.8 Nm (5.31 - 7.08 lb.in)	-

## Environmental data

Ambient temperature ranges	operation	-20...+60 °C
	storage	-40...+85 °C
Damp heat, cyclic (IEC 60068-2-30)		55 °C, 6 cycle
Vibration, sinusoidal (IEC/EN 60255-21-1)		Class 2
Shock (IEC/EN 60255-21-2)		Class 2

## Isolation data

Rated insulation voltage U <sub>i</sub> (VDE 0110, IEC/EN 60947-1, IEC/EN 60255-5)	supply / measuring circuit / output	600 V
	supply / output 1 / output 2	250 V
Rated impulse withstand voltage U <sub>imp</sub> (IEC/EN 60947-1, IEC/EN 60255-5)	supply / measuring circuit / output	6 kV 1.2/50 μs
	supply / output 1 / output 2	4 kV 1.2/50 μs
Test voltage between all isolated circuits (type test)	rated insulation voltage 250 V	2.0 kV, 50 Hz
	rated insulation voltage 600 V	2.5 kV, 50 Hz
Pollution degree (VDE 0110, IEC/EN 60664, IEC/EN 60255-5)		3
Overvoltage category (VDE 0110, IEC/EN 60664, IEC/EN 60255-5)		III

## Standards

Product standard	IEC/EN 60255-6
Low Voltage Directive	2006/95/EC
EMC Directive	2004/108/EC
RoHS Directive	2002/95/EC

## Electromagnetic compatibility

Interference immunity to		IEC/EN 61000-6-2
electrostatic discharge	IEC/EN 61000-4-2	Level 3
radiated, radio-frequency, electromagnetic field	IEC/EN 61000-4-3	Level 3
electrical fast transient / burst	IEC/EN 61000-4-4	Level 3
surge	IEC/EN 61000-4-5	Level 3
conducted disturbances, induced by radio-frequency fields	IEC/EN 61000-4-6	Level 3
Interference emission		IEC/EN 61000-6-3
high-frequency radiated	IEC/CISPR 22, EN 55022	Class B
high-frequency conducted	IEC/CISPR 22, EN 55022	Class B



## Technical diagrams

### Load limit curves

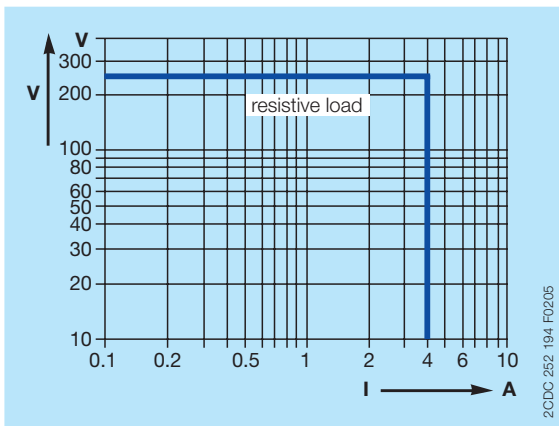

AC load (resistive)

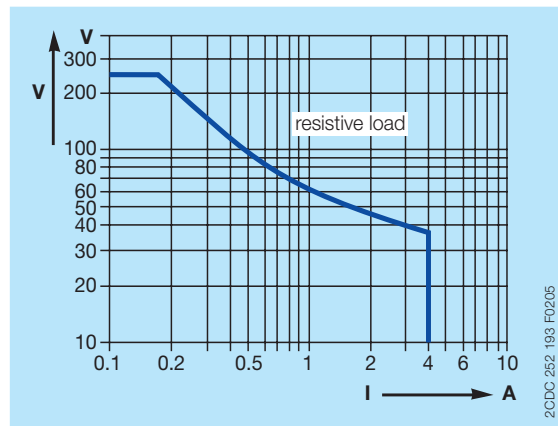

DC load (resistive)

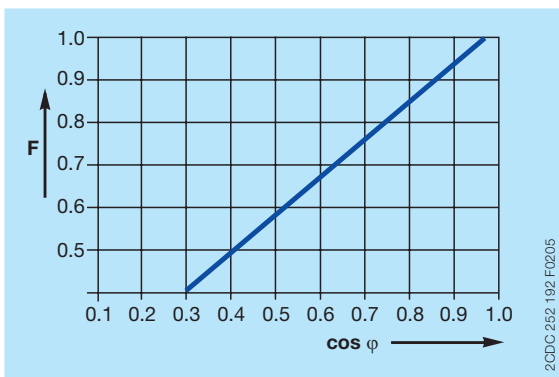

Derating factor F for inductive AC load

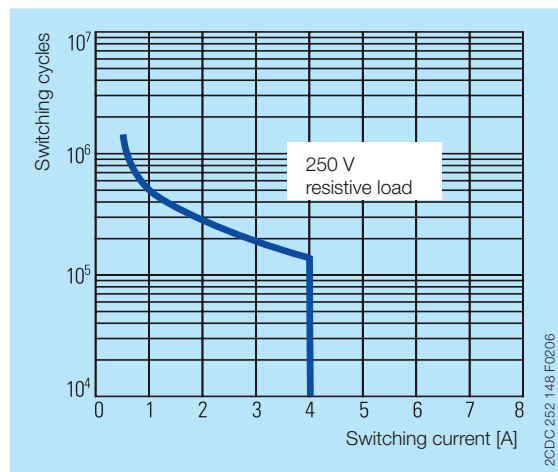

Contact lifetime

## Dimensions

in **mm** and *inches*

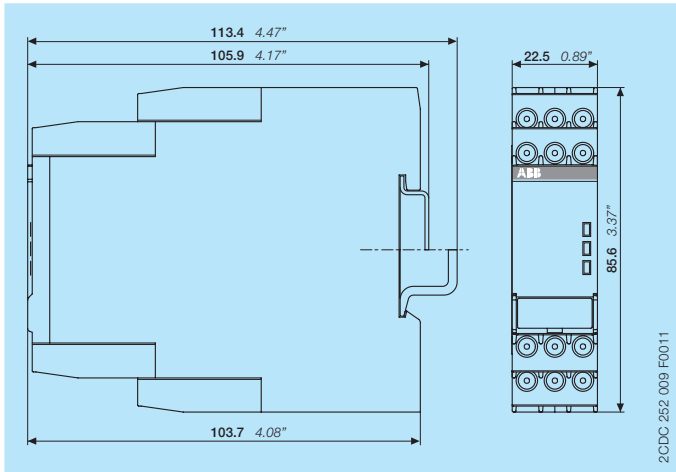

## Accessories

in **mm** and *inches*

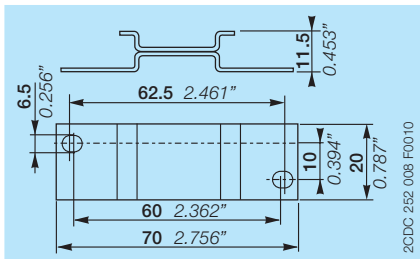

ADP.01 - Adapter for screw mounting

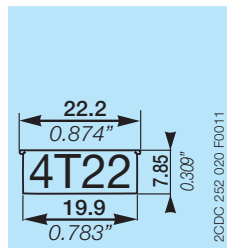

MAR.12 - Marker label for devices with DIP switches

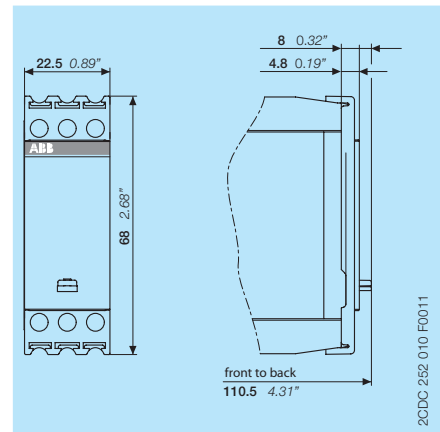

COV.11 - Sealable transparent cover

## Further documentation

Document title	Document type	Document number
Electronic products and relays	Technical catalogue	2CDC 110 004 C020x
CM-ESS.1, CM-ESS.2	Instruction manual	1SVC 730 590 M0000

You can find the documentation on the internet at [www.abb.com/lowvoltage](http://www.abb.com/lowvoltage) -> Control Products -> Electronic Relays and Controls -> Single Phase Monitors

# Contact us

## **ABB STOTZ-KONTAKT GmbH**

P. O. Box 10 16 80  
69006 Heidelberg, Germany  
Phone: +49 (0) 6221 7 01-0  
Fax: +49 (0) 6221 7 01-13 25  
E-mail: info.desto@de.abb.com

You can find the address of your  
local sales organisation on the  
ABB home page  
<http://www.abb.com/contacts>  
-> Low Voltage Products and Systems

### **Note:**

We reserve the right to make technical changes or modify the contents of this document without prior notice. With regard to purchase orders, the agreed particulars shall prevail. ABB AG does not accept any responsibility whatsoever for potential errors or possible lack of information in this document.

We reserve all rights in this document and in the subject matter and illustrations contained therein. Any reproduction, disclosure to third parties or utilization of its contents – in whole or in parts – is forbidden without prior written consent of ABB AG.

Copyright© 2011 ABB  
All rights reserved