

High Performance Amplifier Has Fast Response Time, Longer Sensing Distance and Self-Diagnostic Functions

- Ultra fast 20 μsec. response time (E3X-F)
- Extended sensing distance (E3X-H)
- User friendly features:
  - 8-turn sensitivity with position indicator
  - IP66 enclosure rating
  - Slim body mounts on DIN rail
- Set-mode blinking light source aids alignment

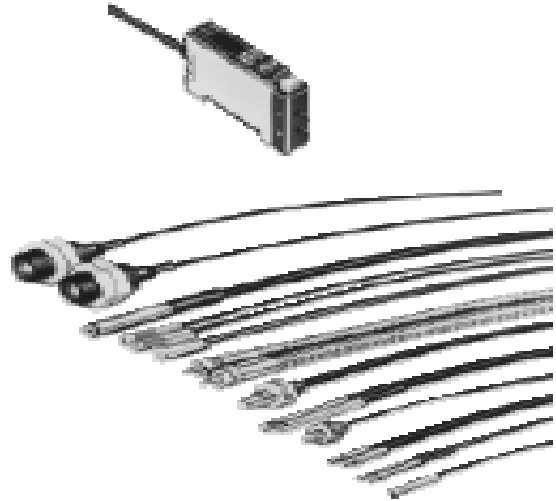

## Ordering Information

### ■ AMPLIFIERS

Part number	NPN output	E3X-A11	E3X-A21	E3X-F21	E3X-VG11	E3X-VG21
	PNP output	E3X-A41	E3X-A51	E3X-F51	—	—
Type	General-purpose			High-speed	Mark sensing	
Self-diagnostic function	None	Provided	Provided	Provided	None	Provided
Off-delay timer	None	Provided	Provided	Provided	None	Provided
Light source	Red LED				Green LED	

### ■ HIGH GAIN AMPLIFIERS

Part number	NPN output	E3X-H11
Type	High sensitivity	
Self diagnostic function	None	
Off-delay timer	Provided	
Light source	Red LED	

### ■ FIBER-OPTIC CABLES

Use E32-series fiber-optic cables. Refer to E32 data sheet in this catalog for specifications.

### ■ ACCESSORIES

Description		Part number
Cover with adjustment knob	Clear cover with gray knob allows sensitivity adjustment without removing cover. Enclosure rating is reduced to IP50.	E39-G3
Replacement cover	Smoked gray plastic like original cover	E39-G4

Note: Neither cover has any printing, such as part number, voltage or wiring information.

# Specifications

Part number		NPN	E3X-A11	E3X-A21	E3X-F21	E3X-VG11	E3X-VG21
		PNP	E3X-A41	E3X-A51	E3X-F51	—	—
Supply voltage		10-30 VDC 10% ripple max.			12-24 VDC±10% 10% ripple max.	10-30 VDC 10% ripple max.	
Current consumption		35 mA max.			40 mA max.		
Required fiber optic cables		All E32-series					
Light source		Pulse-modulated red LED (660 nm)				Pulse-modulated green LED (565 nm)	
Operation mode		Light-ON, Dark-ON or SET modes (switch selectable)					
Sensitivity		8-turn potentiometer with clutch and indicator					
Mutual interference protection		Not provided					
Control output	DC solid-state	Type	NPN — open collector PNP — open collector				
		Max. load	100 mA, 30 VDC max.			100 mA, 40 VDC max.	
		Max. ON-state voltage drop	1 VDC max. at 100 mA				
Response time		200 μs max.			ON: 20 μs max. OFF: 30 μs max.	200 μs max.	
Timing functions		—	OFF-delay, 0.01 to 0.1 sec, adjustable; switch selectable			—	OFF-delay, 0.01 to 0.1 sec, adjustable; switch selectable
Alarm output		—	50 mA, 30 VDC max.			—	50 mA, 40 VDC max.
Check input	Input voltage	—	Light OFF: 1.5 V max.			—	Light OFF: 1.5 V max.
Circuit protection		Output short circuit protection, DC power reverse polarity protection					
Indicators		Light received (red LED) and output stability (green LED)					
Materials	Case	Heat-resistant ABS					
	Cover	Polycarbonate					
Mounting		DIN rail track, or on flat surface through holes in bracket (provided)					
Connections	Prewired	3 conductor cable, 2 m (6.5 ft)	5 conductor cable, 2 m (6.5 ft)			3 conductor cable, 2 m (6.5 ft)	5 conductor cable, 2 m (6.5 ft)
Weight		100 g (3.5 oz.) with 2 m cable					
Enclosure rating	IEC	IP66 (with cover on)					
Ambient temperature	Operating	-25° to 55°C with no ice buildup (-13° to 131°F)					
	Storage	-40° to 70°C (-40° to 158°F)					

## ■ HIGH GAIN AMPLIFIER

Part number		E3X-H11	
Supply voltage		10 - 30 VDC 10% ripple max.	
Current consumption		35 mA max.	
Required fiber optic cables		All E32 series	
Light source		Pulse modulated Red LED (660 nm)	
Operation mode		Light ON, Dark ON	
Sensitivity		8 turn potentiometer	
Control output	DC solid-state	Type	NPN - Open collector
		Max. load	100 mA, 30 VDC
		Max. ON-state voltage drop	1 VDC max. at 100 mA
Response time		1 m sec max.	
Timing functions		OFF DELAY 40 ms Fixed Switch selectable	
Circuit protection		Output short-circuit protection, DC power reverse polarity protection	
Indicators		Light received (Red LED) and output stability (Green LED)	
Materials	Case	Heat resistant ABS	
	Cover	Polycarbonate	
Mounting		DIN rail track, or on flat surface through holes in bracket (provided)	
Connections	Prewired	3 conductor cable 2 m (6.5 ft)	
Weight		100g (3.5 oz) with 2 m cable	
Enclosure ratings	IEC	IP66 (with cover on)	
Ambient temperature	Operating	-25° to -55°C with no icing build-up (-13° to 131°F)	
	Storage	-40° to 70°C (-40° to 158°F)	

# Nomenclature

## E3X-H11

**Stable Operation Indicator** (Green Indicator)

**Sensitivity Indicator**  
The position of the indicator can be checked.

**8-turn Sensitivity Adjuster**

**Mode Selector**

SET: The light source flashes. Set to this mode to adjust the light axis.

L-ON: Output transistor is ON when light is received.

D-ON: Output transistor is ON when light is not received.

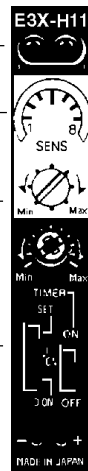

**Light Reception Indicator** (Red Indicator)

**Hysteresis Adjuster**

**Timer Switch**

ON: Timer function is ON.

OFF: Timer function is OFF.

**Light Reception Monitoring Terminal**  
Monitoring is used with the E39-VX Beam Checker

## E3X-A11/A41 E3X-VG11

**Stable Operation Indicator** (Green Indicator)

**8-turn Sensitivity Adjuster**

**Mode Selector**

SET: The light source flashes. Set to this mode to adjust the light axis.

L-ON: Output transistor is ON when light is received.

D-ON: Output transistor is ON when light is not received.



**Light Reception Indicator** (Red Indicator)

**Sensitivity Indicator**  
Sensitivity adjustment can be checked visually.

**Light Reception Monitoring Terminal**  
Monitoring is used with the E39-VX Beam Checker

Note: Set the mode selector to L-ON or D-ON after the light axis is adjusted.

## E3X-A21/A51 E3X-F21/F51 E3X-VG21

**Stable Operation Indicator** (Green Indicator)

**Sensitivity Indicator**

**Timer Sensitivity Adjuster**

**Mode Selector**

SET: The light source flashes. Set to this mode to adjust the light axis.

L-ON: Output transistor is ON when light is received.

D-ON: Output transistor is ON when light is not received.



**Light Reception Indicator** (Red Indicator)

**Timer Switch**

ON: Timer function is ON.

OFF: Timer function is OFF.

**Light Reception Monitoring Terminal**  
Monitoring is used with the E39-VX Beam Checker

# Operation

## OUTPUT CIRCUITS

Type	Model	Mode switch	Output transistor	Output circuit
NPN	E3X-H11 E3X-A11 E3X-VG11	Light ON	ON when light is received.	<p><math>Z_D: V_Z = 39\text{ V}</math></p>
		Dark ON	ON when light is not received.	
	E3X-A21 E3X-VG21 E3X-F21	Light ON	ON when light is received.	<p><math>Z_D</math> (Zener diode): <math>V_Z = 39\text{ V}</math></p>
		Dark ON	ON when light is not received.	
PNP	E3X-A41	Light ON	ON when light is received.	<p><math>Z_D: V_Z = 39\text{ V}</math></p>
		Dark ON	ON when light is not received.	
	E3X-A51 E3X-F51	Light ON	ON when light is received.	<p><math>Z_D</math> (Zener diode): <math>V_Z = 39\text{ V}</math></p>
		Dark ON	ON when light is not received.	

■ TIMING CHARTS











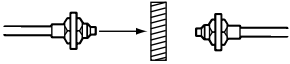

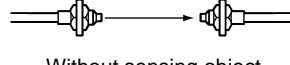

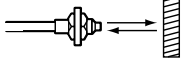

Type	Model	Mode switch	Output transistor	Timing circuit
NPN	E3X-H11 E3X-A11 E3X-VG11	Light ON	ON when light is received.	<p>Light received Light not received</p> <p>Light indicator (Red) ON OFF</p> <p>Output transistor ON OFF</p> <p>Load (relay) Operate release (Between brown and black)</p>
		Dark ON	ON when light is not received.	<p>Light received Light not received</p> <p>Light indicator (Red) ON OFF</p> <p>Output transistor ON OFF</p> <p>Load (relay) Operate release (Between brown and black)</p>
	E3X-A21 E3X-VG21 E3X-F21	Light ON	ON when light is received.	<p>Light received Light not received</p> <p>Light indicator (Red) ON OFF</p> <p>Output transistor ON OFF</p> <p>Load (relay) Operate release (Between brown and black)</p>
		Dark ON	ON when light is not received.	<p>Light received Light not received</p> <p>Light indicator (Red) ON OFF</p> <p>Output transistor ON OFF</p> <p>Load (relay) Operate release (Between brown and black)</p>

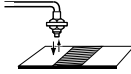
Type	Model	Mode switch	Output transistor	Timing chart
PNP	E3X-A41	Light ON	ON when light is received.	<p>Light received Light not received</p> <p>Light indicator (Red) ON OFF</p> <p>Output transistor ON OFF</p> <p>Load (relay) Operate release (Between blue and black)</p>
		Dark ON	ON when light is not received.	<p>Light received Light not received</p> <p>Light indicator (Red) ON OFF</p> <p>Output transistor ON OFF</p> <p>Load (relay) Operate release (Between blue and black)</p>
	E3X-A51 E3X-F51	Light ON	ON when light is received.	<p>Light received Light not received</p> <p>Light indicator (Red) ON OFF</p> <p>Output transistor ON OFF</p> <p>Load (relay) Operate release (Between blue and black)</p>
		Dark ON	ON when light is not received.	<p>Light received Light not received</p> <p>Light indicator (Red) ON OFF</p> <p>Output transistor ON OFF</p> <p>Load (relay) Operate release (Between blue and black)</p>

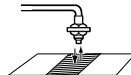
## ■ ADJUSTING SENSITIVITY

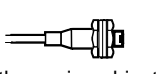
### E3X-H11/-A□□/-F□□/-VG□□

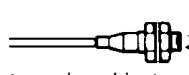
Using a sensing object, set the Sensitivity Adjust so that the indicators operate as described in the following table:

Sensing method		Detection	Light	Indicators
Through-beam		 With sensing object	OFF	 Green: light ON Red: light OFF
		 Without sensing object	ON	 Green: light ON Red: light ON
Reflective	Detection	 With sensing object	ON	 Green: light ON Red: light ON
		 Without sensing object	OFF	 Green: light ON Red: light OFF
	Detection of the difference in color or shade	 Color that has a high reflective ratio	ON	 Green: light ON Red: light ON
		 Color that has a low reflective ratio	OFF	 Green: light ON Red: light OFF
Retroreflective		 With sensing object	OFF	 Green: light ON Red: light OFF
		 Without sensing object	ON	 Green: light ON Red: light ON

Note: 1. If the indicators operate as described in the table, the E3X can operate in stable condition within the rated temperature range.

2. Even when the green indicator is OFF, the E3X will operate stably if the operating temperature change since the initial settings is within  $\pm 10^{\circ}\text{C}$ .



### ■ LIGHT AXIS ADJUSTMENT WITH FLASHING FUNCTION

E3X-A□□/F□□/VG□□

1. Set the mode selector to SET.

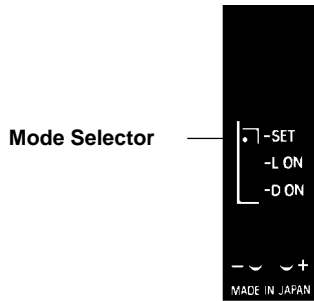

2. Adjust the light axis by moving the fiber with the light flashing.

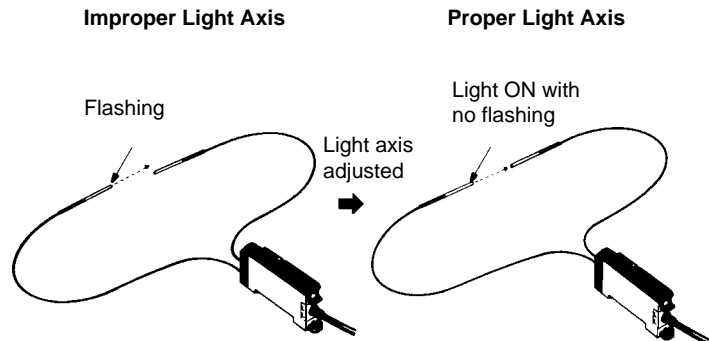

3. Set the mode selector to L-ON or D-ON after the light axis is adjusted.

### ■ SELF-DIAGNOSTIC FUNCTION

With this function, the E3X checks changes in environment conditions (especially a change in the ambient temperature) and self-diagnoses the resistance against the changes. The result is shown by the indicators or an output signal.

**Stable Operation Indicator (Green Indicator)**

**Light Reception Indicator (Red Indicator)**

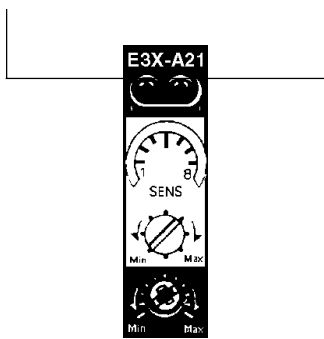

#### Displays

- **Stable Operation Indicator:** Changes in environmental conditions (changes in the ambient temperature, the operating voltage, or the volume of dust) are checked and the resistance against them are self-diagnosed. The result is shown via the indicator.

- **Light Reception Indicator:** The amount of light received is shown by this indicator.

#### Output:

- The resistance against changes in environmental conditions is shown by the indicator and the result is output.

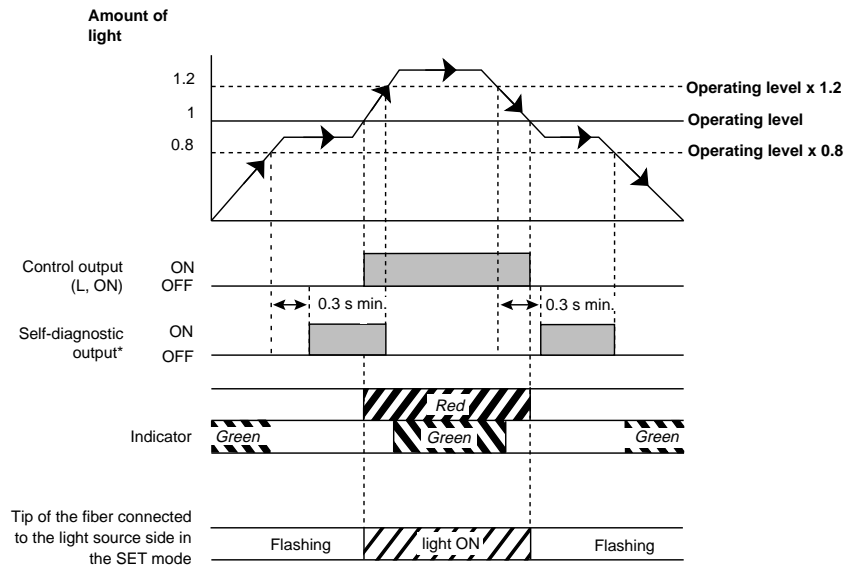

\*If the self-diagnostic output is ON when the sensing object is moving at low speed, use the E3X with an ON-delay timer circuit.

### ■ VARIABLE HYSTERESIS FUNCTION (E3X-H11)

#### Detection of Plate Level Differences

(If detection is impossible with the hysteresis value set to maximum)

Refer to the following when using the hysteresis adjuster.

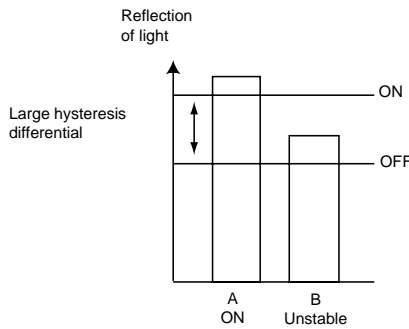

Detecting operation is not stable because zone B is within the hysteresis differential range.

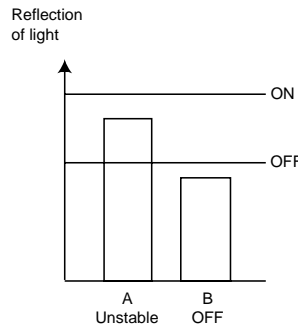

Reduce the sensitivity of the E3X with the sensitivity adjuster and turn off zone B.

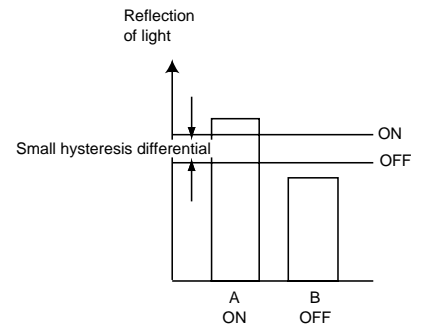

Reduce the hysteresis value with the hysteresis adjuster so that zone A will be ON.

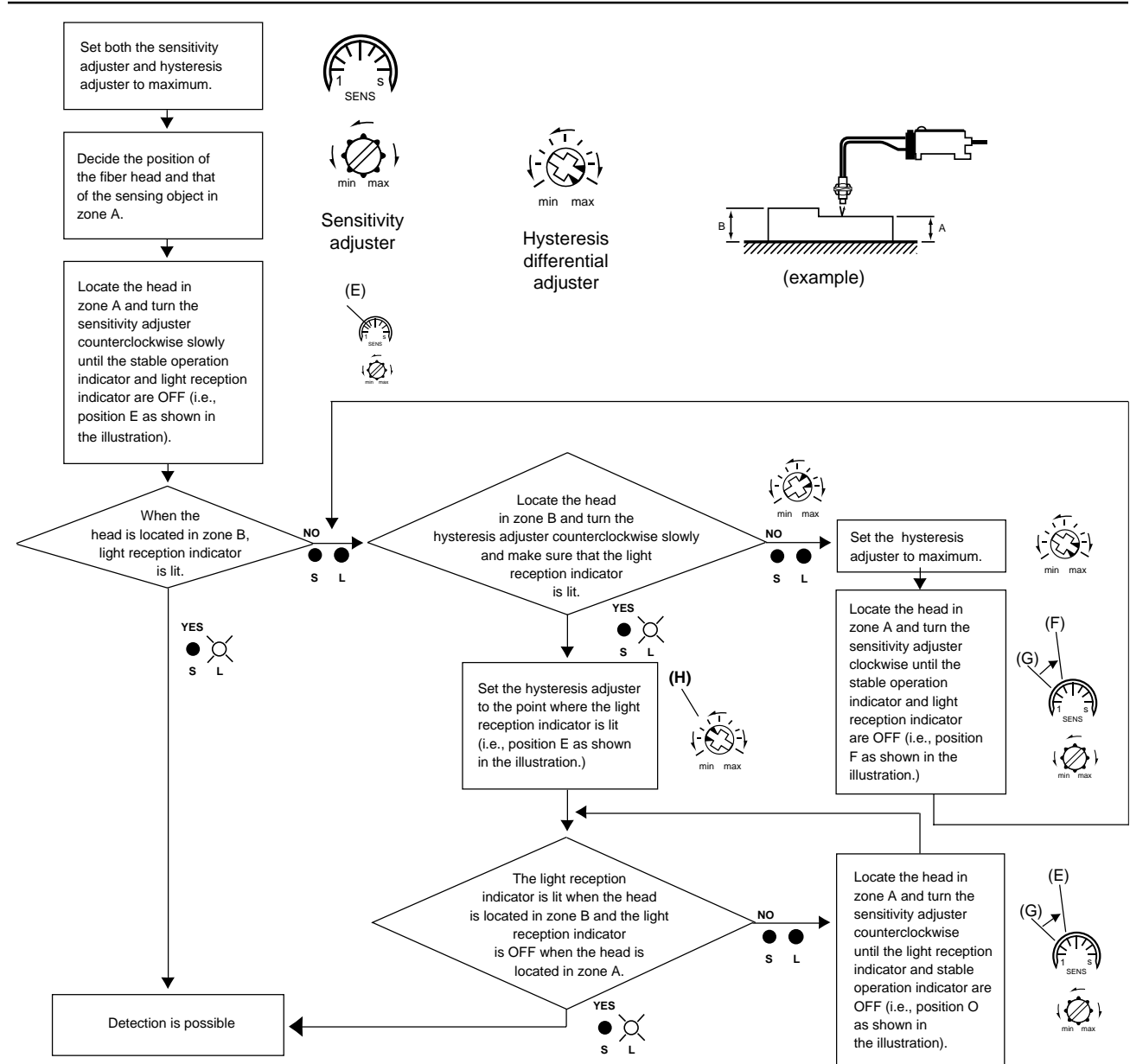

**EXTERNAL DIAGNOSTIC INPUT FUNCTION**

With this function, light projection can be stopped when desired. The operation of the sensor can be checked with this function before the E3X is placed into actual operation.

**E3X-A□□**

Light is emitted from the projection fiber head when the self-diagnostic inputs is ON. The sensor, however, will not operate.

**E3X-F□□/VG□□**

No light is emitted from the projection fiber head when self-diagnostic input is ON.

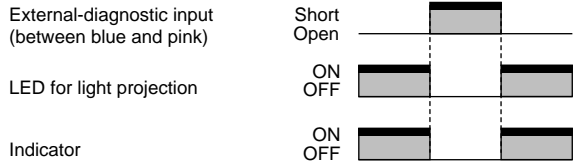
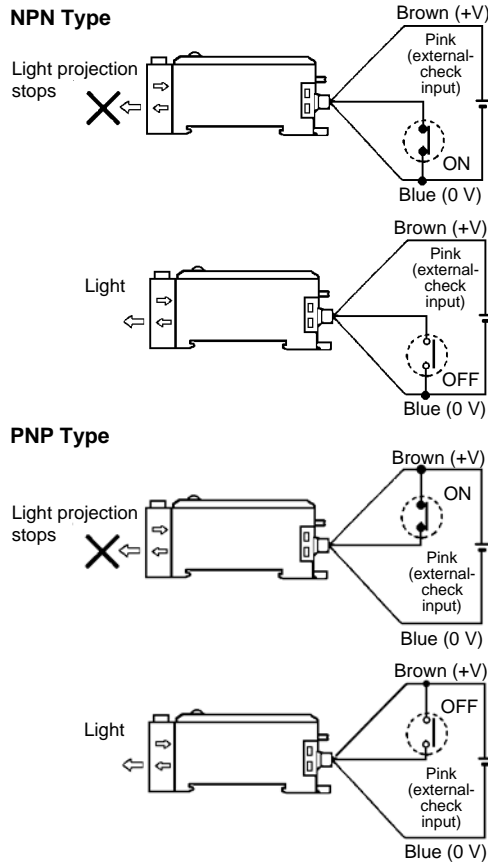

By short-circuiting the pink and blue cords, light projection can be stopped (with a short-circuit current of 0.2 mA max.).

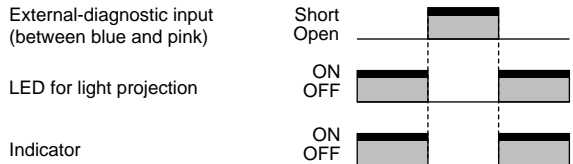

By short-circuiting the brown and pink cords, light projection can be stopped (with a short-circuit current of 0.2 mA max.).

**SPECIAL FIBER UNITS**

The following special accessories are available (order separately). Contact your OMRON representative for the details.

**Fiber Units with Special Length of Stainless Steel Tube**

Fiber with different lengths of stainless steel tubes are available.

**Applicable Models**

- E32-TC200F (tube with 0.9 dia.)
- E32-TC200B/DC200F (tube with 1.2 dia.)
- E32-DC200B (tube with 2.5 dia.)

**Appearance**

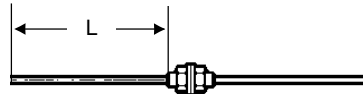

The length can be ordered in increments of 10 mm between 10 mm min. and 120 mm max.

Tolerance: ±1.0 mm if L is 40 mm or less and ±2.0 if L is more than 40 mm. (Note that standard Fiber Units have a 90-mm or 40-mm long stainless steel tube.)

### Fiber Units with 90° Bend in Stainless Steel Tube

#### Applicable Models

E32-TC200B/TC200F/DC200F

#### Appearance

##### Stainless Steel Tube with a 90° Bend at the Tip

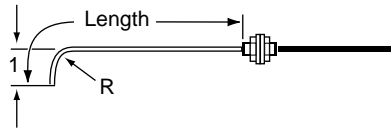

Bending radius	$l1 (\pm 1)$	
R 5.0	10.0 mm	15.0 mm
R 7.5	12.5 mm	17.5 mm
R 10.0	15.0 mm	20.0 mm
R 12.5	17.5 mm	22.5 mm

The length overall is 120 mm max.

Note: If larger  $l1$  is required, use the E39-F11 Sleeve Bender.

##### Stainless Steel Tube with a 90° Bend at the Base

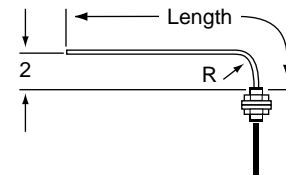

Bending radius	$l2 (\pm 1)$	
R 5.0	5.0 mm	10.0 mm
R 7.5	7.5 mm	17.5 mm
R 10.0	10.0 mm	20.0 mm
R 12.5	12.5 mm	22.5 mm

The length overall is 120 mm max.

Note: If larger  $l2$  is required, use the E39-F11 Sleeve Bender.

### Sensing Distance for Tubes with 90° Bends

Model	Amplifier	Bending radius				
		Standard	R 5.0	R 7.5	R 10.0	R 12.5
E32-TC200B	E3X-H11	400 mm	260 mm	330 mm	360 mm	400 mm
	E3X-A□□	180 mm	110 mm	140 mm	160 mm	180 mm
E32-TC200F	E3X-H11	100 mm	55 mm	100 mm	100 mm	100 mm
	E3X-A□□	50 mm	30 mm	50 mm	50 mm	50 mm
E32-DC200F	E3X-H11	36 mm	30 mm	36 mm	36 mm	36 mm
	E3X-A□□	18 mm	10 mm	18 mm	18 mm	18 mm

### Fiber Unit with Longer Fiber

#### Applicable Models

E32-TC200/-DC200  
E32-TC200B/-DC200B  
E32-TC200E/-DC200E  
E32-TC200F/-DC200F  
E32-TC200A

#### Appearance

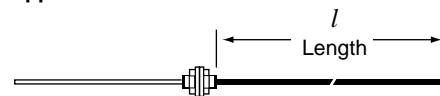

The length can be ordered in increments of 1 m between 6 m min. and 20 m max. (2 m and 5 m fiber length types are standard for E32-TC200, E32-DC200.)

**Fiber Length vs. Sensing Distance**

**Through-beam Fiber Unit**

(Based on the sensing distance using a fiber length of 2 m as 100%)

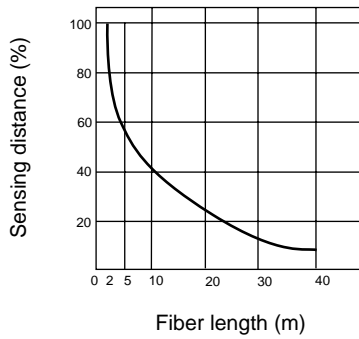

**Reflective Fiber Unit**

(Based on the sensing distance using a fiber length of 2 m as 100%)

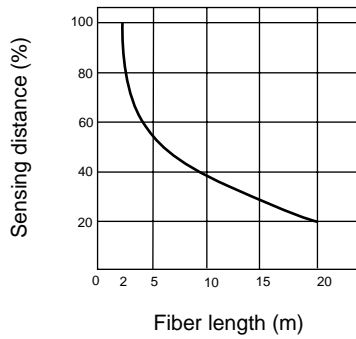

**E3X-A□□, E32-TC200 (Typical)**

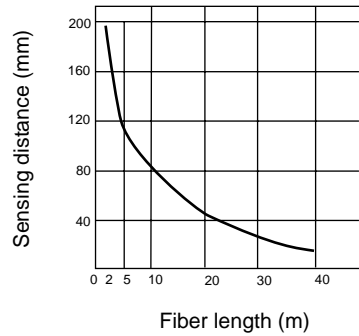

**E3X-A□□, E32-DC200 (Typical)**

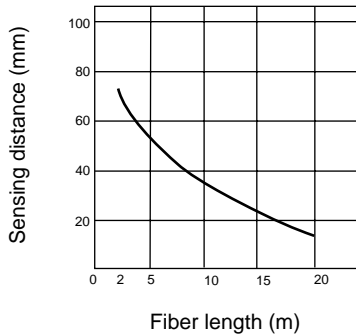

**Dimensions**

Unit: mm (inch)

**AMPLIFIER**

- E3X-H11
- E3X-A□□
- E3X-F□□
- E3X-VG□□

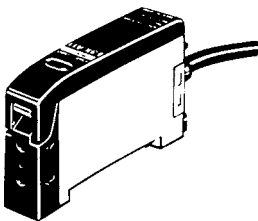

Cable: 2-m polyvinyl chloride-covered cable (4-mm dia., 5 cores\*)  
 Weight: Approx. 100 g  
 \*The cables for the E3X-A11, E3X-A41, and E3X-VG11 models have 3 cores.

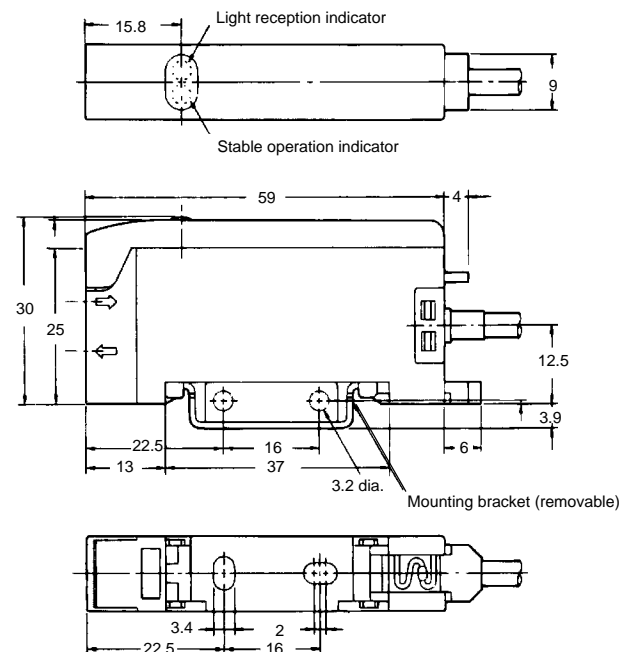
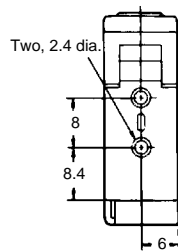

Unit: mm (inch)

REFLECTOR

Reflector (Small)  
E39-R3

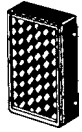

Note: Mounting bracket is attached.

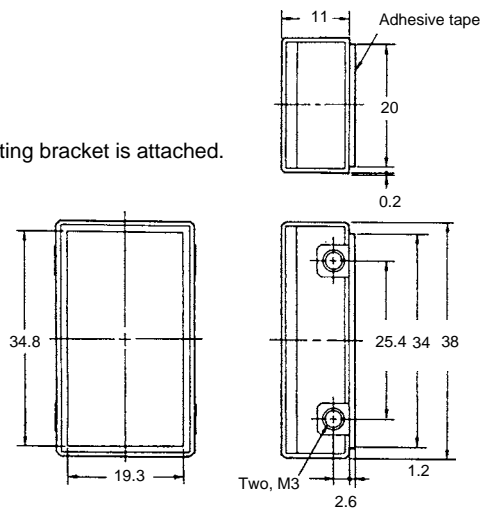

Reflector  
E39-R1

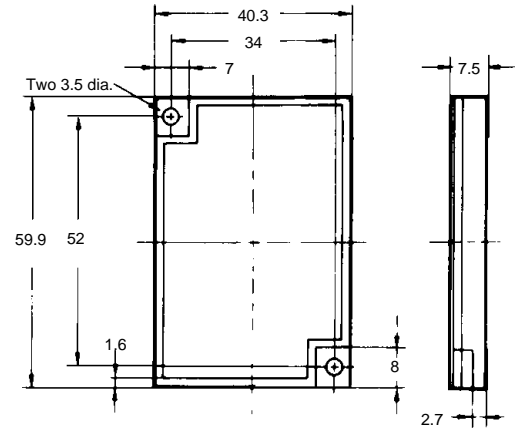
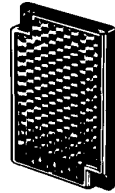

Installation

CONNECTIONS

Connection with S3D2 Sensor Controller

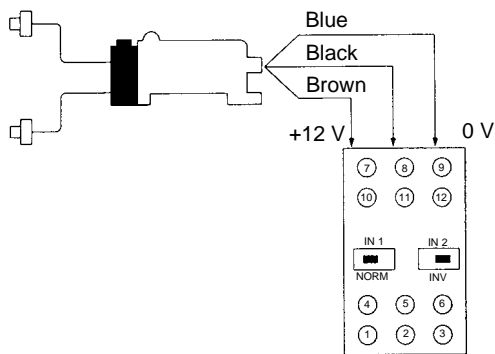

Connection with S3D8 Sensor Controller

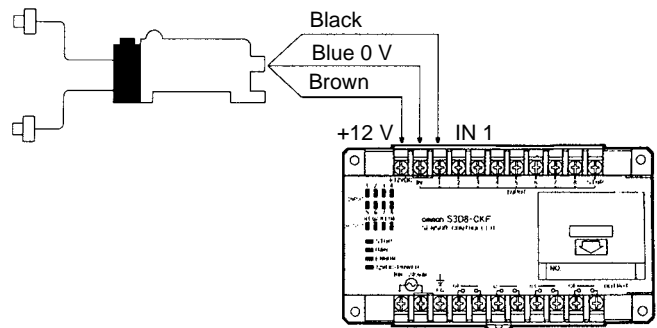

Note: A maximum of two E3X Optical Fiber Photoelectric Sensors can be connected.

Note: A maximum of eight E3X Optical Fiber Photoelectric Sensors can be connected.

Power supply voltage	Output	Functions	NPN input	PNP input
100 to 240 VAC	Relay	AND, OR	S3D2-AK-US	S3D2-AKB-US
		AND, OR, and timer	S3D2-CK-US	S3D2-CKB-US
		Flip-flop	S3D2-BK-US	---
	Transistor	AND, OR, and timer	S3D2-CC-US	S3D2-CCB-US

# Precautions

## ■ FIBER UNITS

### Tightening Force

The tightening force applied to the Fiber Unit should be as follows:

#### Screw-mounting Model

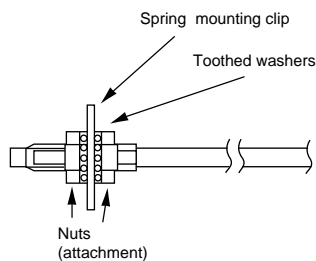

#### Column Model

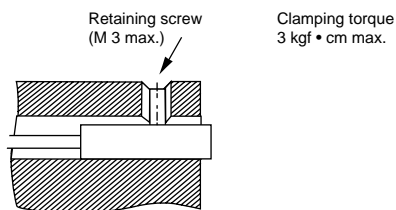

Fiber units	Clamping torque
M3/M4 screw	8 kgf • cm max. (0.78 N • m)
M6 screw	10 kgf • cm max. (0.98 N • m)
2-mm dia. column	3 kgf • cm max. (0.29 N • m)
3-mm dia. column	3 kgf • cm max. (0.29 N • m)
E32-D14L	10 kgf • cm max. (0.98 N • m)
E32-T12F	8 kgf • cm max. (0.78 N • m)
E32-D12F	8 kgf • cm max. (0.78 N • m)
E32-T16	5 kgf • cm max. (0.49 N • m)
E32-R21	6 kgf • cm max. (0.59 N • m)
E32-M21	Up to 5 mm to the tip: 5 kgf • cm max. (0.49 N • m) Up to 5 mm from the tip: 8 kgf • cm max. (0.78 N • m)
E32-L25A	8 kgf • cm max. (0.78 N • m)

Use a proper-sized spanner.

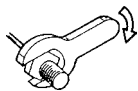

### Fiber Connection and Disconnection

The E3X amplifier has a lever lock. Connect or disconnect the fibers to or from the E3X amplifier using the following procedures:

#### 1. Connection

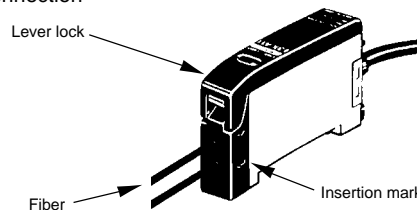

Insert the fibers into the E3X amplifier and press the lever lock until the amplifier clicks to lock the fibers. The fibers will have insertion marks when they are cut with the E39-F4 (Fiber Cutter). The portion from the tips to the insertion mark should be inserted to the E3X.

#### 2. Disconnection

Raise the lock lever to unlock the fibers before pulling them out.

### Fiber Insertion

If the portion from the tip to the insertion mark of the fibers are not inserted into the amplifier unit, the sensing distance will be reduced.

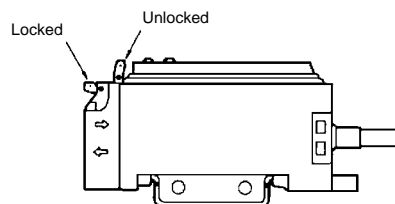

## Connection

Do not pull or press the Fiber Units. The Fiber Units have a withstand force of 1 kg or 3 kg (pay utmost attention because the fibers are thin).

Do not bend the Fiber Units beyond the permissible bending radius.

Do not bend the edge of the Fiber Units.

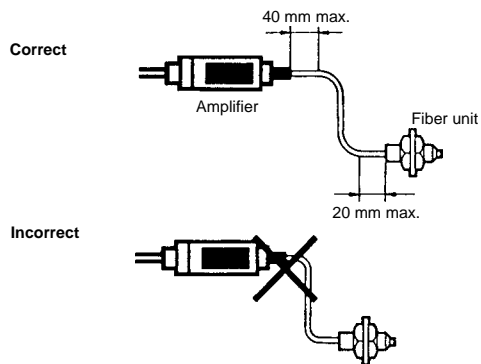

Do not apply excess force on the Fiber Units.

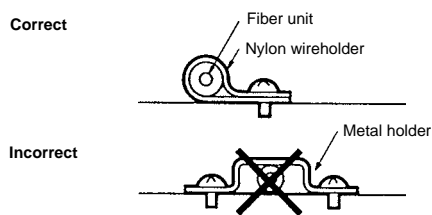

The Fiber Head could be broken by excessive vibration. To prevent this, the following is effective:

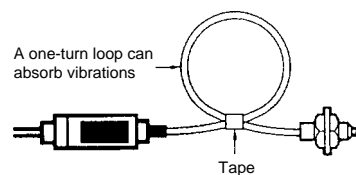

## AMPLIFIER UNITS

### Mounting

1. Mount the front part on the mounting bracket (sold together) or a DIN rail.
2. Press the back part onto the mounting bracket or the DIN rail.

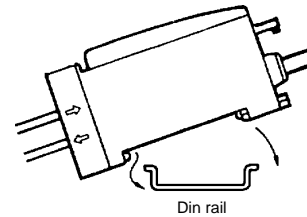

### Removal

By pulling back the lock (yellow) on the bottom with a flat blade screwdriver, the amplifier can be removed with ease.

In the case of side mounting, attach the mounting bracket on the amplifier first, and secure the amplifier with M3 screws and washers. The diameter of the washers should be 6 mm max.

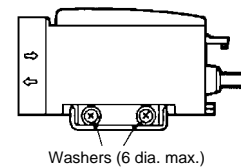

### Others

When power is off:

The moment power is turned off, the E3X could output a pulse signal which could affect the operation of the devices connected to it. This will happen more often if power is supplied to the E3X from an external power supply, thus affecting the connected timer and counter. Use a built-in power supply as much as possible to avoid this.

If power is supplied to a photoelectric sensor through a cord that is wired together with other power lines in the same duct, the cord will be influenced by the power lines and malfunctioning of the photoelectric sensor or damage could result. Wire the cord separately or use a sealed cord to supply power to the photoelectric sensor.

If the case of the cord is extended, use a wire with 0.3 mm<sup>2</sup> max.. The total length of the cord should be 100 m max.

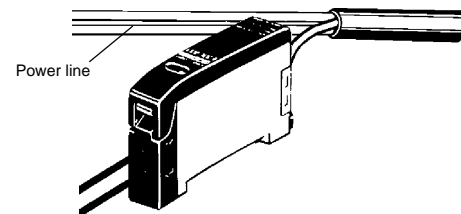

Power supply:

If a standard switching regulator is used as a power supply, the frame ground (FG) terminal and the ground (G) terminal must be grounded, or otherwise the E3X can malfunction, influenced by the switching noise of the power supply.

The supplied voltage must be within the rated voltage range. Unregulated full- or half-wave rectifiers must not be used as power supplies.

Do not use a hammer to hit the amplifier when mounting or the amplifier will lose watertightness.





**OMRON ELECTRONICS LLC**  
One East Commerce Drive  
Schaumburg, IL 60173  
**1-800-55-OMRON**

**OMRON ON-LINE**  
Global - <http://www.omron.com>  
USA - <http://www.omron.com/oei>  
Canada - <http://www.omron.com/oci>

**OMRON CANADA, INC.**  
885 Milner Avenue  
Scarborough, Ontario M1B 5V8  
**416-286-6465**