

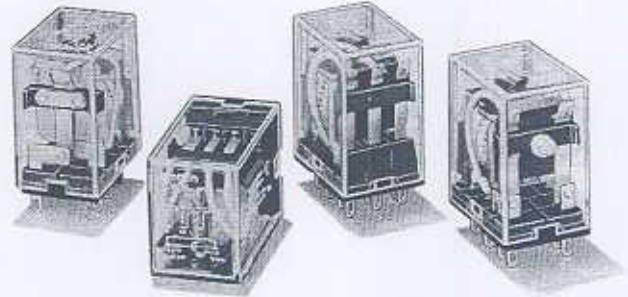



An Improved Miniature Power Relay with Many Models for Sequence Control and Power Applications

- A wide range of relay variations including ones with operation indicators, high-capacity capability, built-in diodes, etc.
- Arc barrier standard on 3- and 4-pole relays.
- Withstand voltage: 2,000 VAC.



Ordering Information

Type	Contact form	Plug-in socket/solder terminals		PCB terminals	Upper-mounting/ solder terminals
			With indicator		
Standard	SPDT	*MY1	—	*MY1-02	MY1F
	DPDT	MY2	MY2N	MY2-02	MY2F
	DPDT (bifurcated)	MY2Z	MY2ZN	MY2Z-02	MY2ZF
	3PDT	MY3	MY3N	MY3-02	MY3F
	4PDT	MY4	MY4N	MY4-02	MY4F
	4PDT (bifurcated)	MY4Z	MY4ZN	MY4Z-02	MY4ZF
With built-in diode (DC only)	DPDT	MY2-D	MY2N-D2	—**	—
	DPDT (bifurcated)	MY2Z-D	MY2ZN-D2	—	—
	3PDT	MY3-D	MY3N-D2	—	—
	4PDT	MY4-D	MY4N-D2	—	—
	4PDT (bifurcated)	MY4Z-D	MY4ZN-D2	—	—
With built-in CR (AC only)	DPDT	MY2-CR	MY2N-CR	—	Not available.
	DPDT (bifurcated)	MY2Z-CR	—	—	
	3PDT	MY3-CR	—	—	
	4PDT	MY4-CR	MY4N-CR	—	
	4PDT (bifurcated)	MY4Z-CR	—	—	
With test button	DPDT	MY2I4	MY2I4N	—	—
	4PDT	MY4I4	MY4I4N	—	—

Socket Hold-down Clip Pairing

Relay type	Poles	Front-connecting sockets (rail/screw-mounted)		Back-connecting sockets			
		Socket	Clip	Solder/wire-wrap terminals		PCB terminals	
				Socket	Clip	Socket	Clip
Standard, bifurcated contacts, operation indicator, built-in diode, high-capacity, high-sensitivity, or high-humidity	1, 2	PYF08A-N, PYF08A-E, PYF08A	PYC-A1	PY08(QN)	PYC-P	PY08(QN)	PYC-P
	3	PYF11A		PY11(QN)		PY11(QN)	
	4	PYF14A-N, PYF14A-E, PYF14A		PY14(QN)		PY14(QN)	
MY2N-D4	4	PYF14A-N, PYF14A-E, PYF14A	Y92H-3	PY14(QN)	PYC-1	PY08(QN)	PYC-1
Test button	1, 2	PYF08A-N, PYF08A-E, PYF08A	PYC-A1	PY08(QN)	PYC-P2	PY08(QN)	PYC-P2
	3	PYF11A		PY11(QN)		PY11(QN)	
	4	PYF14A-N, PYF14A-E, PYF14A		PY14(QN)		PY14(QN)	
CR circuit	1, 2	PYF08A-N, PYF08A-E, PYF08A	Y92H-3	PY08(QN)	PYC-1	PY08(QN)	PYC-1
	3	PYF11A		PY11(QN)		PY11(QN)	
	4	PYF14A-N, PYF14A-E, PYF14A		PY14(QN)		PY14(QN)	

Specifications

■ Coil Ratings

	Rated voltage	Rated current		Coil resistance	Inductance (reference value)		Must operate	Must release	Max. voltage	Power consum. (Approx.)
		50 Hz	60 Hz		Arm. OFF	Arm. ON				
AC	6 V	214.1 mA	183 mA	12.2 Ω	0.04 H	0.08 H	80% max.	30% min.	110%	1.0 to 1.2 VA (60 Hz)
	12 V	106.5 mA	91 mA	46 Ω	0.17 H	0.33 H				
	24 V	53.8 mA	46 mA	180 Ω	0.69 H	1.30 H				
	50 V	25.7 mA	22 mA	788 Ω	3.22 H	5.66 H				
	100/110 V	11.7/12.9 mA	10/11 mA	3,750 Ω	14.54 H	24.6 H				
	110/120 V	9.9/10.8 mA	8.4/9.2 mA	4,430 Ω	19.20 H	32.1 H				
	200/220 V	6.2/6.8 mA	5.3/5.8 mA	12,950 Ω	54.75 H	94.07 H				
	220/240 V	4.8/5.3 mA	4.2/4.6 mA	18,790 Ω	83.50 H	136.40 H				
DC	6 V	150 mA		40 Ω	0.17 H	0.33 H	10% min.		0.9 W	
	12 V	75 mA		160 Ω	0.73 H	1.37 H				
	24 V	36.9 mA		650 Ω	3.20 H	5.72 H				
	48 V	18.5 mA		2,600 Ω	10.60 H	21.00 H				
	100/110 V	9.1/10 mA		11,000 Ω	45.60 H	86.20 H				

Note: See notes under next table on next page.

High-sensitivity Relays

Power supply ratings					Input ratings			
Voltage	Current	Coil resistance	Max. voltage*	Power consum.	Input voltage	Must operate	Must release	Power consum.
					% of rated voltage			
24 VDC	36.9 mA	650 W	110%	Approx. 900 mW	2 to 12 V	2 V max.	1 V min.	0.5 to 52 mW

- Note: 1. The rated current and coil resistance are measured at a coil temperature of 23°C with tolerances of +15%/-20% for rated currents and ±15% for DC coil resistance.
2. Performance characteristic data are measured at a coil temperatures of 23°C.
3. The must operate and must release voltages for High-sensitivity Relays was measured at the rated power supply voltage.
4. AC coil resistance and impedance are provided as reference values (at 60 Hz).
5. Power consumption drop was measured for the above data. When driving transistors, check leakage current and connect a bleeder resistor if required.

■ Contact Ratings

Item	Single-, double- or three-pole		Four-pole and High-sensitivity		High-capacity	
	Resistive load (cosφ = 1)	Inductive load (cosφ=0.4, L/R=7 ms)	Resistive load (cosφ = 1)	Inductive load (cosφ=0.4, L/R=7 ms)	Resistive load (cosφ = 1)	Inductive load (cosφ=0.4, L/R=7 ms)
Rated load	5 A, 220 VAC 5 A, 24 VDC	2 A, 220 VAC 2 A, 24 VDC	3 A, 220 VAC 3 A, 24 VDC	0.8 A, 220 VAC 1.5 A, 24 VDC	7 A, 220 VAC 7 A, 24 VDC	3.5 A, 220 VAC 3.5 A, 24 VDC
Carry current	5 A		3 A		7 A	
Max. switching voltage	250 VAC 125 VDC		250 VAC 125 VDC		250 VAC 125 VDC	
Max. switching current	5 A	5 A	3 A	3 A	7 A	7 A
Max. switching capacity	1,100 VA 120 W	440 VA 48 W	660 VA 72 W	176 VA 36 W	1,540 VA 168 W	770 VA 84 W
Min. permissible load*	Standard type: 100 mA, 5 VDC Bifurcated type: 100 μA, 1 VDC		Standard and high sensitivity types: 1 mA, 1 VDC Bifurcated type: 100 μA, 1 VDC		—	

*Note: P level: $\lambda_{60} = 0.1 \times 10^{-6}$ /operation, reference value

■ Characteristics

Item	All relays but High-sensitivity Relays	High-sensitivity Relays
Contact resistance	50 mΩ max.	
Operate time	20 ms max.	
Release time	20 ms max.	
Max. operating frequency	Mechanical: 18,000 operations/hr Electrical: 1,800 operations/hr (under rated load)	
Insulation resistance	1,000 MΩ min. (at 500 VDC)	
Dielectric withstand voltage	2,000 VAC, 50/60 Hz for 1 min (1,000 VAC between contacts of same polarity)	1,500 VAC, 50/60 Hz for 1 min (1,000 VAC between contacts of same polarity)
Vibration resistance	Destruction: 10 to 55 Hz, 1.0-mm double amplitude Malfunction: 10 to 55 Hz, 1.0-mm double amplitude	
Shock resistance	Destruction: 1,000 m/s ² (approx. 100G) Malfunction: 200 m/s ² (approx. 20G)	
Life expectancy	See following table.	
Ambient operating temperature*	Single- and double-pole standard, bifurcated-contact, test-button, and high-humidity relays: -55°C to 70°C (with no icing) All other relays: -55°C to 60°C (with no icing)	
Ambient operating humidity	35% to 85%	
Weight	Approx. 85 g	

Note: The values given above are initial values.

■ Approved by Standards

Some MY Relays are available in models meeting various safety standards. When ordering, you must specify the desired standards. Refer to *Ordering Information* for specific models. Note that the ratings recognized by the various standards sometimes vary from the ratings of the individual relays.

UL 508 Recognitions (File No. 41515)

No. of poles	Coil ratings	Contact ratings
2	6 to 240 VAC 6 to 120 VDC	5 A, 120 VAC resistive load 5 A, 28 VDC resistive load 5 A, 240 VAC inductive load
3		5 A, 28 VDC resistive load 5 A, 240 VAC inductive load
4	6 to 240 VAC 6 to 120 VDC	3 A 28 VDC resistive load 3 A 120 VAC inductive load 1.5 A, 240 VAC inductive load 5 A, 240 VAC inductive load (between contacts of same polarity) 5 A, 28 VDC resistive load (between contacts of same polarity) 0.2 A, 120 VDC

CSA 22.2 No. 0 and No.14 (File No. LR31928)

Model	No. of poles	Coil ratings	Contact ratings
MY□	2, 3	6 to 240 VAC 6 to 120 VDC	5 A, 28 VDC resistive load 5 A, 240 VAC inductive load
	4		3 A, 28VDC resistive load 3 A, 240 VAC inductive load 5 A, 240 VAC inductive load (between contacts of same polarity) 5 A, 28 VDC resistive load (between contacts of same polarity) 0.2 A, 120 VDC

SEV

Model	No. of poles	Coil ratings	Contact ratings
MY□	2, 3	6 to 100 VDC 6 to 220 VAC	5 A, 200 VAC 5 A, 24 VDC

LR (No. 563KOB-204524)

Model	No. of poles	Coil ratings	Contact ratings
MY□-LR	2	6 to 240 VAC 6 to 120 VDC	2 A, 30 VDC inductive load 2 A, 200 VAC inductive load
	4		1.5 A, 30 VDC inductive load 0.8 A, 200 VAC inductive load 1.5 A, 115 VAC inductive load

Engineering Data

■ Maximum Switching Capacity

MY1, MY2, MY3

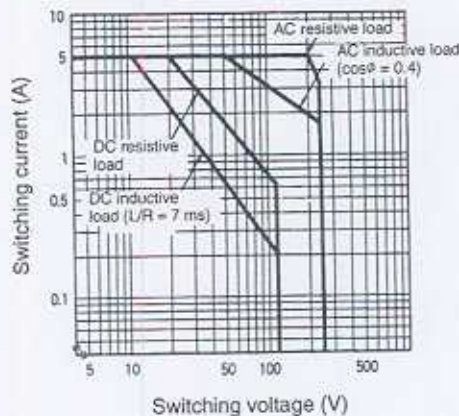

MY2-Y

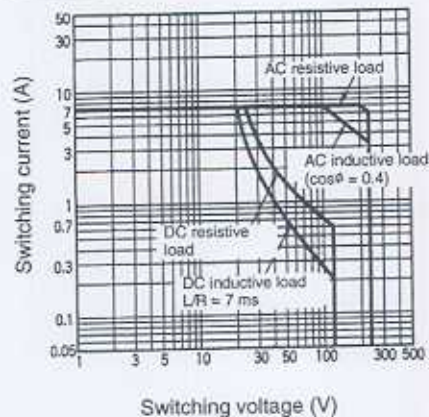

MY4, MY4Z

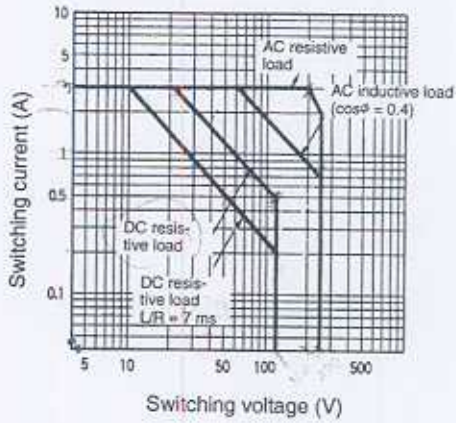

■ Life Expectancy

MY1, MY2, MY3 (Resistive Loads)

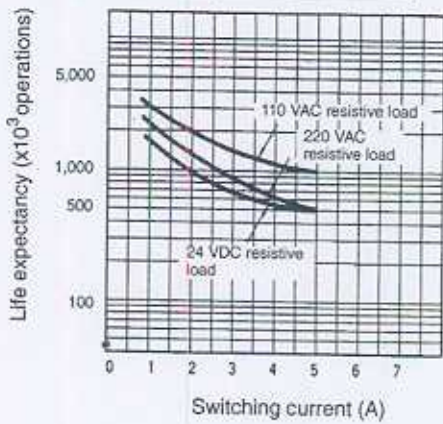

MY1, MY2, MY3 (Inductive Loads)

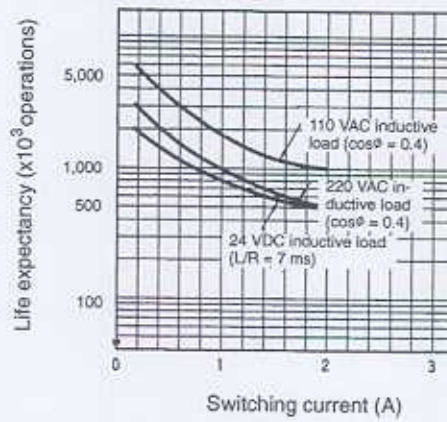

MY4 (Resistive Loads)

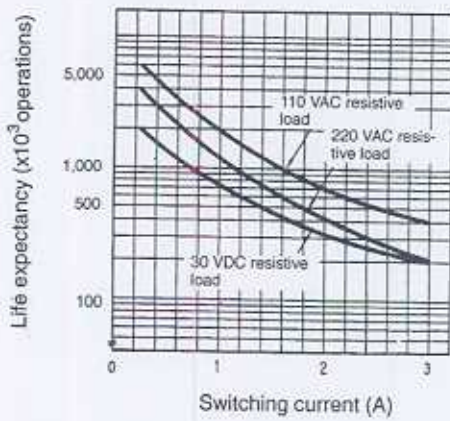

MY4 (Inductive Loads)

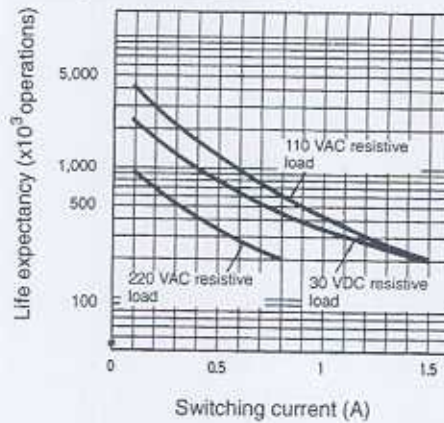

Dimensions

Note: All units are in millimeters unless otherwise indicated.

Relays with Solder Terminals

MY1

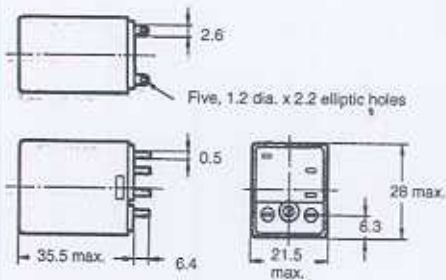

Terminal arrangement/internal connections (bottom view)

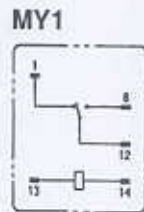

MY2, MY2-TU, MY2N, MY2N-D2

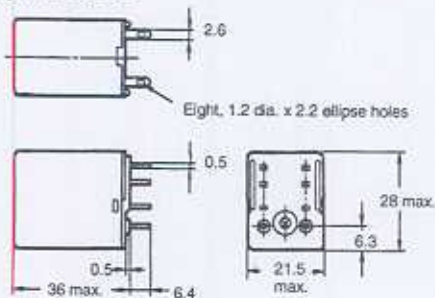
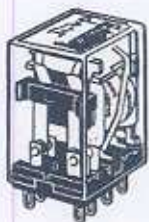

Standard

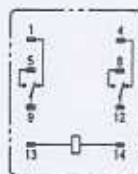

MY2N

DC type

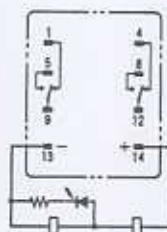

AC type

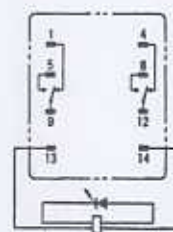

- Note: 1. AC type is equipped with a coil disconnection self-diagnostic function.
2. Pay due attention as DC type has polarity.

MY2N-D2

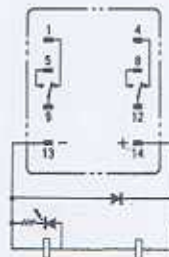

MY4, MY4-TU

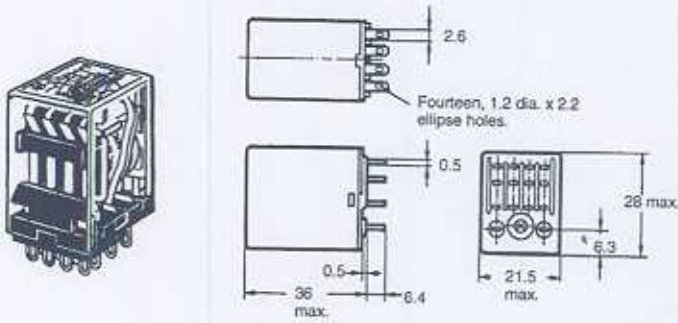

Terminal arrangement/internal connections (bottom view)

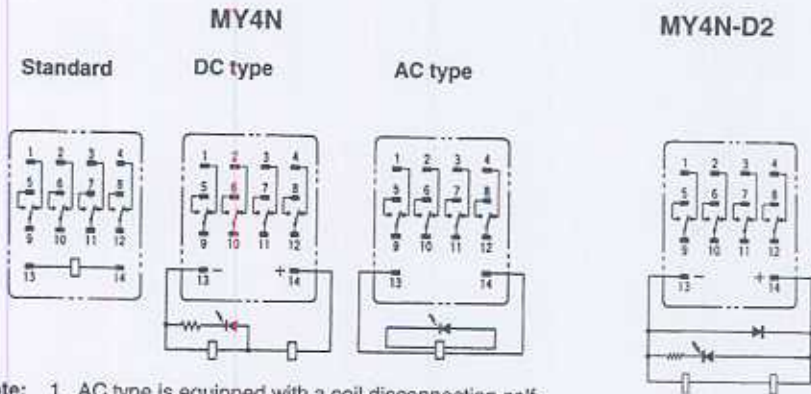

- Note:**
1. AC type is equipped with a coil disconnection self-diagnostic function.
 2. Do not reverse the polarity of DC relays.

MY□I4

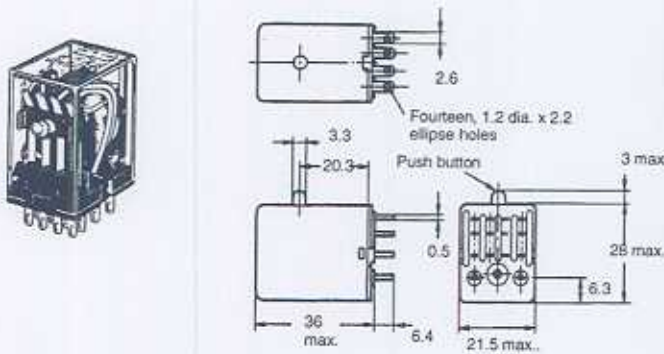

MY□I

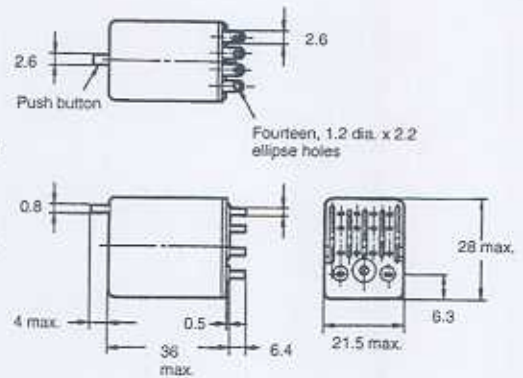

- Note:**
1. Mount the relay with a socket.
 2. The above dimensions are for -G type relays (with mounting studs).
 3. Test button
I4: AC with red push button
DC with blue push button

Mounting holes

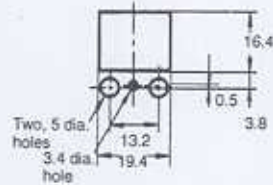

Note: The terminal arrangement and internal connections of the above relays are as same as these of MY□ relays.