

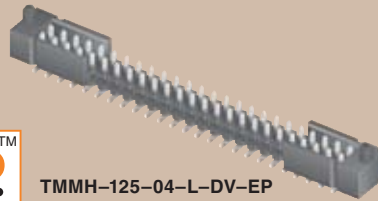

(2,00mm) .0787"

TMMH SERIES



TMMH-125-04-L-DV-EP

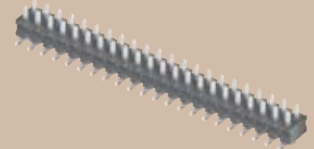

TMMH-122-04-T-DV-LC

# FLEXIBLE SMT HEADER

## SPECIFICATIONS

For complete specifications and recommended PCB layouts see [www.samtec.com?TMMH](http://www.samtec.com?TMMH)

**Insulator Material:** Black Liquid Crystal Polymer  
**Terminal Material:** Phosphor Bronze  
**Plating:** Sn or Au over 50µ" (1,27µm) Ni  
**Operating Temp Range:** -55°C to +105°C with Tin; -55°C to +125°C with Gold  
**Voltage Rating:** 500 VAC mated with SQW  
**RoHS Compliant:** Yes



| AMBIENT TEMP | CURRENT RATING |      |
|--------------|----------------|------|
|              | Mated with     |      |
|              | ESQT           | SQW  |
| 20°C         | 5.8A           | 5A   |
| 40°C         | 5.1A           | 4.6A |
| 60°C         | 4.5A           | 4A   |
| 95°C         | 2.9A           | 2.6A |

6 POSITIONS (2x3) POWERED

**Processing:** Lead-Free Solderable: Yes  
 SMT Lead Coplanarity: (0,10mm) .004" max

Mates with: CLT, SQT, SQW, ESQT, TLE, SMM, MMS, TCSD

## OPTIONS

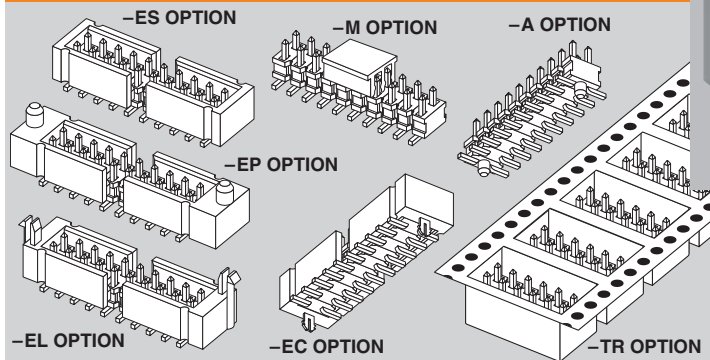

## FLEX SHROUD

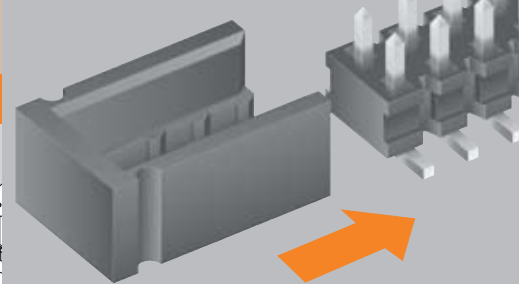

## ALSO AVAILABLE

Through-Hole

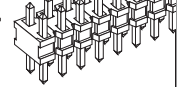

## 2mm Shunt

Specify 2SN-BK-G for 2mm shunt with Gold plating.



|        |        |
|--------|--------|
| (4,45) | (3,99) |
| -.175  | -.157  |
| (1,95) |        |
| -.077  |        |

TMMH

1

NO. PINS PER ROW

LEAD STYLE

PLATING OPTION

03 thru 50

Specify LEAD STYLE from chart

-F = Gold flash on post, Matte Tin on tail  
 -L = 10µ" (0,25µm) Gold on post, Matte Tin on tail  
 -T = Matte Tin

| OPTION     | Z           |
|------------|-------------|
| -ES        | (2,92) .115 |
| -EC        | (4,70) .185 |
| -EP & -EPC | (6,10) .240 |
| -EL & -EBC | (4,45) .175 |

| LEAD STYLE | A           | MATES WITH                          |
|------------|-------------|-------------------------------------|
| -01        | (3,20) .126 | SQT, SQW, ESQT, TLE, SMM, MMS, TCSD |
| -04        | (1,91) .075 | CLT                                 |
| -05        | (1,65) .065 |                                     |

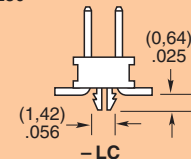
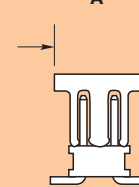
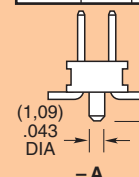
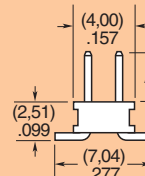
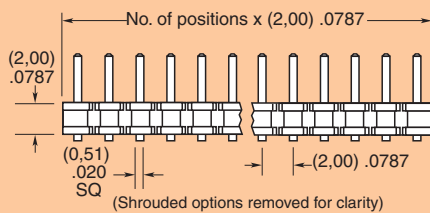
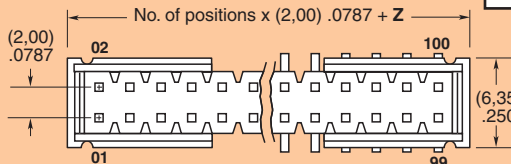

**Note:** Some lengths, styles and options are non-standard, non-returnable.

Due to technical progress, all designs, specifications and components are subject to change without notice.

[WWW.SAMTEC.COM](http://WWW.SAMTEC.COM)

TMMH-116-04-F-DV-EL

TMMH-110-01-T-DV-A

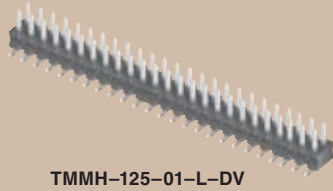

TMMH-125-01-L-DV

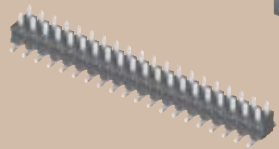
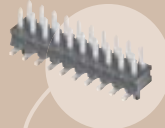

TMMH-120-04-T-DV

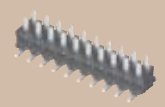
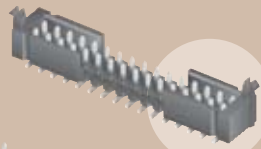

TMMH-110-04-F-DV

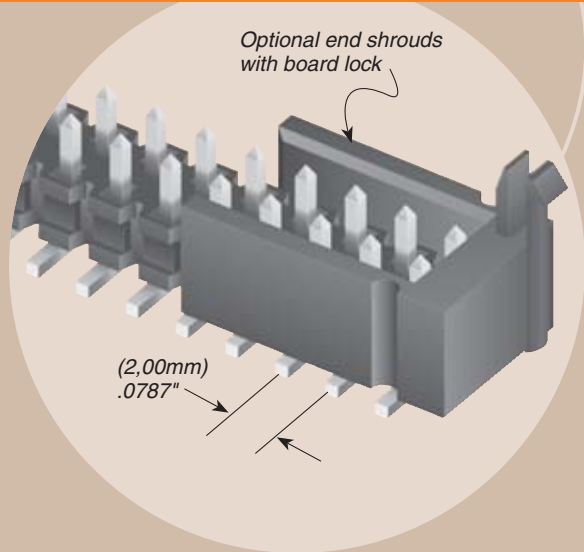
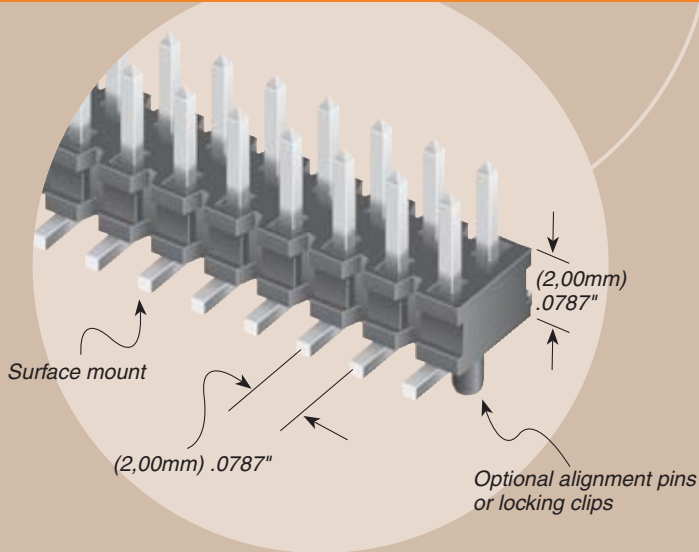

**DV**

**FLEX SHROUD OPTIONS**

**OTHER OPTIONS**

All Flex Shroud options require 9 pins/row minimum (For board-to-board interfaces. Will not mate with TCSD)

**-ES**

= End Shroud  
(For best cost also see TSH Series)

**-EC**

= End Shroud with Locking Clip  
(For best cost also see TSH Series)  
(Manual placement required)

**-EP**

= End Shroud with Guide Post

**-EL**

= End Shroud with Board Lock  
(Boards are positively locked and cannot be unmated)

**-EBC**

= End Shroud with Board Lock and Locking Clip  
(Boards are positively locked and cannot be unmated)

**-EPC**

= End Shroud with Guide Post and Locking Clip  
(Manual placement required)

**-"XXX"**

= Polarized Position. Specify position of omitted pin

**-A**

= Alignment Pin  
(3 positions minimum)  
(N/A with -LC)

**-LC**

= Locking Clip  
(5 positions minimum)  
(N/A with -A)  
(Manual placement required)

**-M**

= Pick & Place Pad  
(5 positions minimum)  
(N/A with -T plating)

**-TR**

= Tape & Reel Packaging  
(Flex Shroud options not available except -ES, -EP & -EL)

| LEAD STYLE | X           | Y           |
|------------|-------------|-------------|
| -01        | (5,84) .230 | (4,45) .175 |
| -04 & -05  | (4,50) .177 | (3,02) .119 |

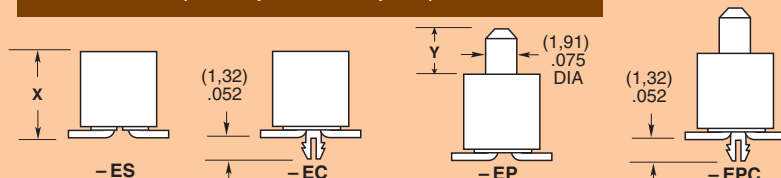
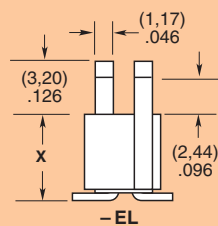
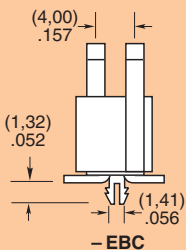

Due to technical progress, all designs, specifications and components are subject to change without notice.

[WWW.SAMTEC.COM](http://WWW.SAMTEC.COM)

**TAPE & REEL AVAILABILITY**

No tooling charges.  
Minimum order is the lesser of a full reel quantity or 125 pieces. Order any quantity above minimum. In-house design, manufacture. Quick turn-around.

Call Samtec for specifications and ordering information.