

TECHNICAL CHARACTERISTICS

MATERIAL
 INSULATOR: NYLON 66
 FLAMABILITY RATING: UL94-V0
 COLOR: WHITE
 PITCH: 4.20MM

ENVIRONMENTAL
 OPERATING TEMPERATURE: -40 UP TO 105°C
 COMPLIANCE: LEAD FREE AND ROHS

ELECTRICAL
 CURRENT RATING: 8 TO 9A

NB CIRCUITS	2-3	4-5
AMPERES	9	8

WORKING VOLTAGE: 600V AC
 INSULATOR RESISTANCE: >1000 MOHM
 DIELECTRIC WITHSTANDING VOLTAGE: 1500V AC/MN

STANDARD
 CERTIFIED: E323964 / MODEL NUMBER 649-0133

PACKAGING
 TRAY

DIMENSION
 A = 4.20 x (NB. PIN - 1)
 B = 4.20 x (NB. PIN) + 1.20

RoHS Compliant			
H	08-NOV-11	DRAWING	GG
REV	DATE	FILE	BY

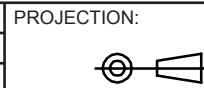

APPROVAL: RJ

GENERAL TOLERANCE
 .X = +/- 0.2
 .XX = +/- 0.15



UNIT: MM
 SCALE:
 SHEET: 1/2
 DRAW: MARY

DESCRIPTION: 4.20MM FEMALE SINGLE ROW RECEPTACLE
 WERI PART NO: 649 0xx 013 322

SIZE
A4

1

2

3

4

5

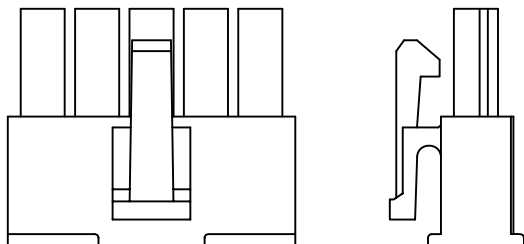
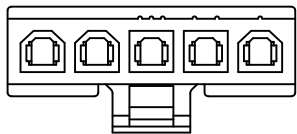

Note:

1.Dimension:

Carton Size:40*28*28(cm)

2.Quantity:

Pin.	Pcs/Bag	Pcs/Carton	Pin.	Pcs/Bag	Pcs/Carton
2	1000	20000	8	500	6000
3	1000	20000	9	500	6000
4	1000	15000	10	500	4000
5	1000	15000	11	500	3000
6	1000	10000	12	500	3000
7	1000	10000			

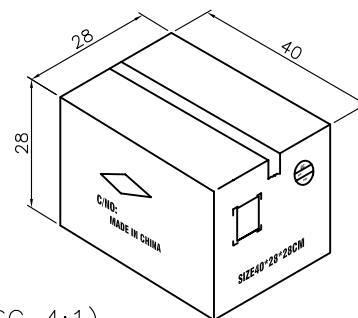
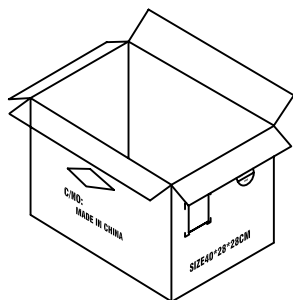
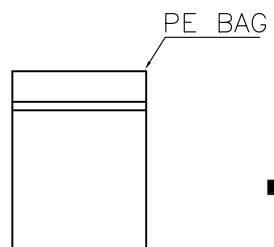

Carton (SC 4:1)

RoHS Compliant

G

F

E

D

C

B

A

REV

DATE

FILE

BY

PROJECTION:

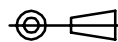

APPROVAL: RJ

GENERAL TOLERANCE

.X = +/- 0.2

.XX = +/- 0.15

UNIT: MM

SCALE:

SHEET: 2/2

DRAW: PEARL



DESCRIPTION: 4.20MM FEMALE SINGLE ROW RECEPTACLE

WERI PART NO: 6490 xx 013322_TPK

SIZE

A4