

**Signal Contacts**

**Type III+, Crimp, Snap-In**

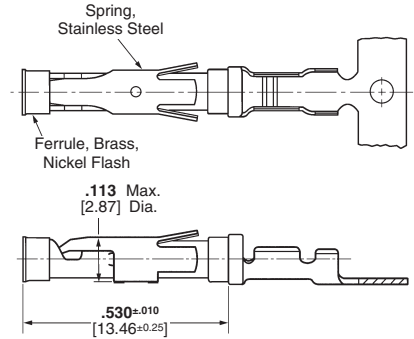

**Material and Finish** — See chart.  
**Contact Body**—Brass or phosphor bronze  
**Retention Spring**—Stainless steel

**Application Tooling**—Page 29  
**Technical Documents**  
 114-10004 Application Specification  
 108-10042 Product Specification

**Contact Size 16—Pin Diameter .062 [1.57] (Test Current, 13 Ampere)†**

†Single contact, free-air test current is not to be construed as contact rating current. Use only for testing. Refer to contact current carrying capability information on page 8.

AWG	Wire Size Range mm <sup>2</sup>	Ins. Dia. Range	Contact Finish	Strip Form Contact No.		Loose Piece Contact No.		Tooling Part No.**	
				Pin	Socket	Pin	Socket	Loose Piece Hand Tool	Strip Form Applicators
30-28	0.05-0.09	.015-.030 0.38-0.76	Gold/Nickel <sup>2</sup>	788085-3	788088-2	—	—	90716-1	567867-1*** or 567947-1*** or 680602-□***
			Sel. Gold/Nickel <sup>3</sup>	788085-1	788088-1	788085-4	788088-3		—
30-26	0.05-0.15	.040-.060 <sup>1</sup> 1.02-1.52	Bright Tin	1-66425-2	1-66424-1	—	—	91515-1 <sup>6</sup>	466598-□***
			Gold/Nickel <sup>2</sup>	66425-7	66424-7	66429-3	66428-3		
			Sel. Gold/Nickel <sup>3</sup>	66425-8	66424-8	66429-4	66428-4		
			Gold/Nickel <sup>2</sup>	66393-7	66394-7	—	—		
26-24	0.12-0.2	.035-.055 <sup>1</sup> 0.89-1.40	Sel. Gold/Nickel <sup>3</sup>	66393-8	66394-8	66406-4	66405-4	90225-2 <sup>6</sup>	466585-3***
			Bright Tin	1-66106-5	1-66108-5	1-66107-1	1-66109-7		
			Gold/Nickel <sup>2</sup>	66106-7	66108-7	66107-3	66109-3		
			Sel. Gold/Nickel <sup>3</sup>	66106-8	66108-8	66107-4	66109-4		
24-20	0.2-0.6	.040-.080 <sup>1</sup> 1.02-2.03	Sel. Gold/Nickel <sup>4</sup>	—	66108-1	—	66109-1	91515-1 <sup>6</sup> or 58495-1*	466321-□*** or 466908-2***
			Bright Tin	2-66102-5	3-66104-0	1-66103-8	1-66105-9		
			Gold/Nickel <sup>2</sup>	66102-8	66104-8	66103-3	66105-3		
			Sel. Gold/Nickel <sup>3</sup>	66102-9	66104-9	66103-4	66105-4		
			Sel. Gold/Nickel <sup>4</sup>	2-66102-2 <sup>7</sup>	2-66104-3 <sup>7</sup>	—	—		
			Sel. Gold/Nickel <sup>4</sup>	—	66104-1	—	66105-1		
18-16	0.8-1.4	.080-.100 <sup>1</sup> 2.03-2.54	Bright Tin	1-66564-2	1-66563-1	66566-7	66565-7	91542-1 <sup>6</sup>	466383-4*** or 466979-1*** or 567363-□***
			Sel. Gold/Nickel <sup>3</sup>	66564-8	66563-8	66566-4	66565-4		
			Bright Tin	1-66332-4	1-66331-4	1-66400-0	1-66399-0		
			Gold/Nickel <sup>2</sup>	66332-7	66331-7	66400-3	66399-3		
			Sel. Gold/Nickel <sup>3</sup>	66332-8	66331-8	66400-4	66399-4		
			Sel. Gold/Nickel <sup>4</sup>	—	66331-2	—	66399-2		
18-14	0.8-2.0	.080-.100 <sup>1</sup> 2.03-2.54	Bright Tin	1-66098-9 <sup>5</sup>	1-66100-9	1-66099-5	1-66101-9	91505-1 <sup>6</sup> or 91523-1 <sup>6</sup> or 58495-1*	466325-□*** or 466906-1***
			Gold/Nickel <sup>2</sup>	66098-8	66100-8	66099-3	66101-3		
			Sel. Gold/Nickel <sup>3</sup>	66098-9	66100-9	66099-4	66101-4		
			Sel. Gold/Nickel <sup>4</sup>	66098-6	—	66099-1	—		
			Bright Tin	1-66359-4	1-66358-6	1-66361-2	1-66360-2		
			Phos Bronze	1-66359-5	1-66358-8	1-66359-5	1-66358-8		
18-14	0.8-2.0	.110-.150 <sup>5</sup> 2.79-3.81	Gold/Nickel <sup>2</sup>	66359-9	66358-9	66361-4	66360-4	91519-1 <sup>6</sup>	466326-□*** or 466923-2***
			Sel. Gold/Nickel <sup>3</sup>	1-66359-0	1-66358-0	66361-4	66360-4		
			Sel. Gold/Nickel <sup>3</sup>	1-66359-2	1-66358-3	66361-8	66360-8		
			Sel. Gold/Nickel <sup>4</sup>	—	66358-1	—	66360-1		
			Bright Tin	66597-8	66598-9	66602-8	66601-9		
			Sel. Gold/Nickel <sup>3</sup>	1-66598-0	1-66598-0	66602-2	66601-2		

<sup>1</sup>Overall insulation crimp diameter, including crimp barrel, must not exceed .125 [3.18].  
<sup>2</sup>.000015 [0.00038] gold in the mating area over .000050 [0.00127] min. nickel.  
<sup>3</sup>.000030 [0.00076] gold in the mating area, with gold flash on remainder, over .000050 [0.00127] min. nickel.  
<sup>4</sup>.000030 [0.00076] gold in the mating area, with gold gradient on remainder, over .000050 [0.00127] min. nickel.

<sup>5</sup>Contacts can ONLY be used in: Metrimate; CPC Series 1 (Arr. 23-24), Series 4 (Arr. 23-13M, 23-16M, 23-22M), and VDE connectors.  
<sup>6</sup>To use with the 626 Pneumatic Tool: remove crimping head from Straight Action Hand Tool (SAHT), order SAHT Adapter Part No. 217201-1, Adapter Holder Part No. 356304-1 (with ratchet) or 189928-1 (without), and Power Unit Part No. 189721-1 (hand actuated) or 189722-1 (foot actuated).  
<sup>7</sup>Phosphor Bronze

<sup>8</sup>Standard reeling of strip form contacts.  
<sup>\*</sup>Commercial PRO-CRIMPER II hand tool for field repair only. Note: Die Set can be adapted for use with 626 Pneumatic Tool System. Insertion Tool Part No. 91002-1 (for insulation diameters .070 [1.78] or less), No. 200893-2 (for insulation diameters .090 [2.29] max.). Extraction Tool Part No. 305183. (Instruction Sheet 408-1216)  
<sup>\*\*</sup>There are power options available for these tools/dies. See Battery Powered Crimp tool Kit and SDE Electric Terminator on page 30.  
<sup>\*\*\*</sup>Call Technical Support for Machine Applicator Part Numbers.

**Note:** All part numbers are RoHS compliant.

**Signal Contacts** (Continued)

**Type III+, Crimp, Snap-In**

**Contact Size**—16  
**Pin Diameter**—.062 [1.57]

**Material and Finish**  
**Contact Body**—Copper alloy, plated tin or gold  
**Spring**—Stainless steel

**Grounding Pin**  
 (make first - break last)

**Related Product Data**  
**Application Tooling**—Pages 29, 30  
**Technical Documents**—Page 4

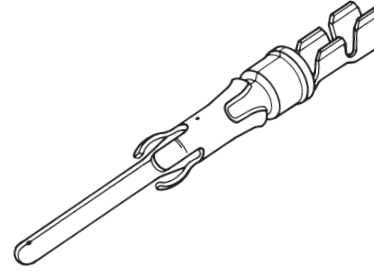

Wire Size Range		Ins. Dia. Range <sup>1</sup>	Contact Finish	Grounding Pin Part No.		Strip Form Applicator Part No.	Loose Piece Hand Tool** Part No.
[mm <sup>2</sup> ]	AWG			Strip Form	Loose Piece		
0.12-0.2	26-24	.035-.055 0.89-1.4	Tin	164159-3	164162-1	—	91515-1 <sup>3</sup> or 58495-1*
			Sel. Gold/Nickel <sup>2</sup>	164159-4	164162-2		
0.2-0.6	24-20	.045-.070 1.14-1.78	Tin	164160-3	164163-1	466323-□ <sup>3</sup>	91515-1 <sup>3</sup> or 91505-1 <sup>3</sup> or 58495-1*
			Sel. Gold/Nickel <sup>2</sup>	164160-4	164163-2	466907-2 <sup>3</sup>	
0.8-1.4	18-16	.078-.098 1.98-2.49	Tin	164161-3	164164-1	466741-□ <sup>3</sup>	91523-1 <sup>3</sup> or 91505-1 <sup>3</sup> or 58495-1*
			Sel. Gold/Nickel <sup>2</sup>	164161-4	164164-2	680114-3 <sup>3</sup>	

<sup>1</sup>Overall insulation crimp diameter, including crimp barrel, must not exceed .125 [3.18].  
<sup>2</sup>Gold flash over .000030 [0.00076] min. nickel on entire contact, with .000030 [0.00076] gold in contact area.  
<sup>3</sup>To use with the 626 Pneumatic Tool System: remove the crimping head from the Straight Action Hand Tool (SAHT) Assembly, order SAHT Adapter **Part No. (Call Technical Support at 800-522-6752)**, Adapter Holder **Part No. 356304-1** (with ratchet) or **189928-1** (without), and Power Unit **Part No. 189721-1** (hand actuated) or **189722-1** (foot actuated).  
 \*Commercial PRO-CRIMPER II hand tool for field repair only. **Note:** Die Set can be adapted for use with the 626 Pneumatic Tool System.  
 \*\*There are power options available for these tools/dies. See Battery Powered Crimp tool Kit and SDE Electric Terminator on page 30.  
 \*\*\*Call Technical Support at 1-800-522-6752 for Automatic Machine Applicator Part Numbers.  
**Extraction Tool Part No. 725840-1**  
**Note:** All part numbers are RoHS compliant.

**Type III+, Solder Versions**

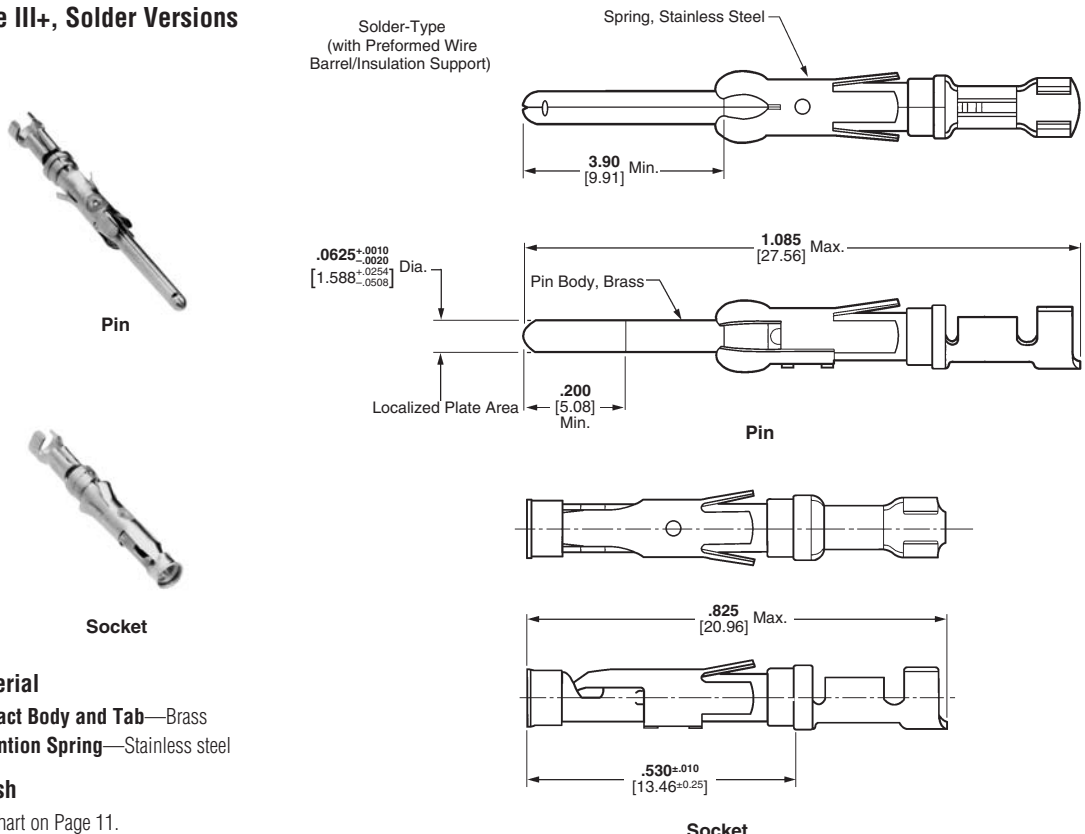

**Material**  
**Contact Body and Tab**—Brass  
**Retention Spring**—Stainless steel  
**Finish**  
 See chart on Page 11.

**Signal Contacts** (Continued)

**Type III+, Solder Versions**  
(Continued)



Pin



Socket



**Material**

**Contact Body and Tab**—Brass

**Retention Spring**—Stainless steel

**Finish**

See chart.

**Contact Size 16—Pin Diameter .062 [1.57] (Test Current, 13 Ampere)‡**

Wire Size Range		Contact Finish	Loose Piece Contact No.	
AWG	[mm <sup>2</sup> ]		Pin	Socket
26-20	0.12-0.6	Gold/Nickel <sup>1</sup>	66182-1♦	66183-1♦
18-16	0.8-1.4	Gold/Nickel <sup>1</sup>	66180-1♦	66181-1♦
Solder Tab		Duplex <sup>2</sup>	202236-7♦	202237-7♦
		Bright Tin	202236-5♦	202237-5♦

<sup>1</sup>0.00030 [0.00076] gold in mating area over .000050 [0.00127] nickel.

<sup>2</sup>Duplex plated .000030 [0.00076] gold in mating area over .000050 [0.00127] nickel on contact body; bright tin-lead on solder tab.

<sup>3</sup>Bright tin on entire contact.

**Note:** These contacts can be used in Multimate contact cavities of all connector housings.

‡Single contact, free-air test current is not to be construed as contact rating current. Use only for testing.

Refer to contact current carrying capability information on page 3.

Extraction Tool **Part No. 305183** (Instruction Sheet 408-1216)

**Note:** All part numbers are RoHS compliant except: ♦ Indicates non-RoHS compliant.

**Signal Contacts** (Continued)

**Type III+, Posted**  
(Replacement Contacts,  
See Note Below)



Pin



Socket

**Material**

**Contact Body and Post**—Brass

**Retention Spring**—Stainless steel

**Finish**

See chart.



**Contact Size 16—Pin Diameter .062 [1.57] (Test Current, 13 Ampere)‡**

Termination Method	Post Configuration	Contact Finish	Loose Piece Contact No.					
			3 Termination High Post		2 Termination High Post		1 Termination High Post	
			Pin	Socket	Pin	Socket	Pin	Socket
Wrap-Type	.025 x .025 0.64 x 0.64	Sel. Gold/Nickel <sup>1</sup>	6-66460-4	6-66461-3	6-66460-3	6-66461-2	6-66460-2	5-66461-5
		Bright Tin	6-66460-6	5-66461-9	6-66460-7	5-66461-8	6-66460-5	5-66461-4
	.045 x .045 1.14 x 1.14	Sel. Gold/Nickel <sup>1</sup>	1-66471-5	2-66473-0	—	—	1-66471-8	1-66473-9
		Bright Tin	1-66471-7	1-66473-8	—	—	1-66471-6	1-66473-7
TERMI-POINT Clip	.031 x .062 0.79 x 1.57	Sel. Gold/Nickel <sup>1</sup>	1-66470-1	—	—	—	1-66470-0	—
		Sel. Gold/Nickel <sup>1</sup>	1-66468-3	1-66459-0	—	—	—	—

<sup>1</sup>Gold flash over .000050 [0.00127] nickel on entire contact, with .000030 [0.00076] gold to a distance of .200 [5.08] from mating end. Gold thickness controlled on socket O.D.

Posts plated tin-lead over copper.

Extraction Tool **Part No. 305183** (Instruction Sheet 408-1216)

Insertion Tool **Part No. 200893-2**

**Note:** These contacts are used as replacement contacts for all posted connectors.

‡Single contact, free-air test current is not to be construed as contact rating current. Use only for testing. Refer to contact current carrying capability information on page 3.

**Note:** All part numbers are RoHS compliant.

**Signal Contacts** (Continued)

**Enhanced High Current Type III+, Crimp, Snap-In**



**Material and Finish** — See chart.  
**Contact Body**—Copper Nickel Alloy  
**Retention Spring**—Stainless steel

**Related Product Data**

**Application Tooling** — Pages 75-78

**Technical Documents**

114-10004 Application Specification  
 108-10024-2 Product Specification

**Contact Size 16—Pin Diameter .062 [1.57]**

Wire Size Range		Ins. Dia. Range	Contact Finish	Strip Form Contact No.		Loose Piece Contact No.		Tooling Part No.**	
AWG	mm <sup>2</sup>			Pin	Socket	Pin	Socket	Loose Piece Hand Tool	Strip Form Applicators
18-14	0.8-2.0	.080-.100 <sup>1</sup> 2.03-2.54	Gold	1-66359-6	1-66358-9	1-66361-4	1-66360-4	91519-1 <sup>3</sup>	466326-□*** or 466923-2***
			Tin	1-66359-9	2-66358-1	1-66361-6	1-66360-6		466958-1*** or 567364-□***
		.110-.150 <sup>2</sup> 2.79-3.81	Gold	1-66597-0	1-66598-1	66602-9	1-66601-0	91521-1 <sup>3</sup>	466958-1*** or 567364-□***
			Tin	1-66597-1	1-66598-2	1-66602-0	1-66601-2		

<sup>1</sup> Overall insulation crimp diameter, including crimp barrel, must not exceed .125 [3.18].  
<sup>2</sup> Contacts can ONLY be used in CPC, Series 1 (Arr. 23-24), Series 4 (Arr. 23-13M, 23-16M, 23-22M), and VDE connectors.  
<sup>3</sup> To use with the 626 Pneumatic Tool System: remove the crimping head from the Straight Action Hand Tool (SAHT) Assembly, order SAHT Adapter **Part No. 217201-1**, Adapter Holder **Part No. 356304-1** (with ratchet) or **189928-1** (without), and Power Unit **Part No. 189721-1** (hand actuated) or **189722-1** (foot actuated).  
 \*\*There are power options available for these tools/dies. See Battery Powered Crimp tool Kit and SDE Electric Terminator on page 30.  
 \*\*\*Call Technical Support for Automatic Machine Applicator Part Numbers.

**Note:** All part numbers are RoHS compliant.

**Ratings Voltage:** 250 Volts AC/DC  
 600 Volts AC/DC, Series I, VDE tested and select loaded only

**Base Current:** Type III+ contacts: 17 amperes, 30°C temperature rise with single contact on 14 AWG wire  
**Enhanced High Current Type III+ contacts: 25 amperes**, 30°C temperature rise with single contact on 14 AWG wire

**Temperature:** -55°C to +105°C

**VDE 0627:** XA/630/4KV/2 - Series I, VDE tested only

**Multiplication Rating Factor (F)**

**Type III+ Contacts (Note: 1 = 17 amperes)**

Shell Size	Percent Connector Loading					
	Single Circuit		≈ 50%		100%	
	Wire Size		Wire Size		Wire Size	
	30 AWG	14 AWG	30 AWG	14 AWG	30 AWG	14 AWG
11-4	.291	1	.212	.905	.140	.684
13-9	.278	.995	.175	.750	.134	.567
17-16	.270	.990	.146	.625	.127	.472
23-24	.281	.985	.138	.550	.120	.416
23-37	.275	.985	.131	.497	.114	.376

**Enhanced High Current Type III+ Contacts (14 AWG wire only - Note: 1 = 25 amperes)**

Shell Size	Percent Connector Loading		
	Single Circuit	≈ 50%	100%
	14 AWG	14 AWG	14 AWG
11-4	.880	.840	.640
13-9	.880	.640	.480
17-16	.880	.520	.400
23-24	.880	.520	.400
23-37	.880	.440	.320

**Enhanced High Current Contacts & M Series Connectors: (Note: 1 = 24 amperes)**

Single Circuit	≈ 50%	≈ 100%
14 AWG	14 AWG	14 AWG
1	.292	.250

**Enhanced High Current Contacts & Metrimate Connectors: (Note: 1 = 24 amperes)**

Single Circuit	≈ 50%	≈ 100%
14 AWG	14 AWG	14 AWG
1	.458	.375

**Signal Contacts** (Continued)

**Type II, Screw Machined, Crimp**

**Material**

**Contact Body**—Brass

**Retention Spring**—Stainless steel

**Finish**

**Contact Body**—.000030 [0.00076] gold over .000050 [0.00127] nickel. Gold thickness controlled on socket O.D.

**Retention Spring**—Stainless steel

**Related Product Data**

**Application Tooling**—Pages 75-78



Pin



Socket

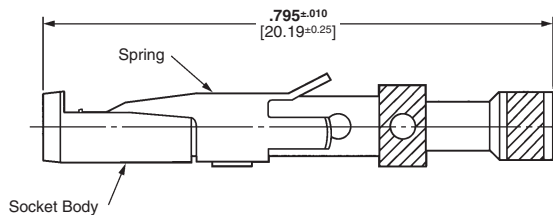

Socket

**Contact Size 16—Pin Diameter .062 [1.57] (Test Current, 13 Ampere)†**

Wire Size Range		Ins. Dia. Range <sup>1</sup>	Tape Mounted Contact No. <sup>2</sup>		Loose Piece Contact No.		Contact Color Code	Tooling Part No. <sup>**</sup>		
			Pin	Socket	Pin	Socket		Tape Mounted Dies for AMP-TAPETRONIC Machine 69875	Loose Piece Die Set for 626 Pneumatic Tool System	Hand Tool
28-24	0.08-0.20	.035-.055 0.89-1.40	201611-4	—	201611-1 <sup>4</sup>	201613-1 <sup>5</sup>	Red/Red	90249-2	90230-1 <sup>7</sup>	91538-1 or 601967-1
		.048-.065 1.22-1.65	—	—	201334-1 <sup>4</sup>	201332-1 <sup>5</sup>	Red/Red		—	—
		.095-.110 2.41-2.79	—	—	202410-1 <sup>4</sup>	202411-1 <sup>5</sup>	Green	—	—	601967-1
24-20	0.2-0.6	.040-.062 1.02-1.57	201578-4	—	201578-1 <sup>4</sup>	201580-1 <sup>5</sup>	Yellow/Red	90249-2	90230-1 <sup>7</sup>	91538-1 or 58541-1 <sup>*</sup>
		.055-.088 1.40-2.16	201330-6	201328-9	201330-1 <sup>4</sup>	201328-1 <sup>5</sup>	Yellow/Red		—	—
18 (Two)	0.9-0.9 (Two)	No. Ins. Support	—	—	202725-1 <sup>4</sup>	202726-1 <sup>4</sup>	Blue	—	90231-2 <sup>7</sup>	91539-1 or 601967-1
18-16	0.8-1.4	.080-.105 2.03-2.67	—	—	202507-1 <sup>4</sup>	202508-1 <sup>5</sup>	—	—	—	90136-1 or 601967-1
		No Ins. Support	200336-6	200333-8	200336-1 <sup>4</sup>	200333-1 <sup>4</sup>	Blue/Blue	90250-1	90231-2 <sup>7</sup>	91539-1 58541-1 <sup>*</sup> or 601967-1
14	2	No Ins. Support	212618-2 <sup>3</sup>	—	212618-1 <sup>3,6,†</sup>	—	Violet/Blue	90250-1	90231-2 <sup>7</sup>	91539-1 58541-1 <sup>*</sup> or 601967-1
		No Ins. Support	201570-2	201568-3	201570-1 <sup>4</sup>	201568-1 <sup>5</sup>	Violet/Blue	—	—	—

<sup>1</sup>Overall insulation crimp diameter, including crimp barrel, must not exceed .125 [3.18].

<sup>2</sup>For AMP-TAPETRONIC Machine No. 69875, order contacts by Tape Mounted Contact No., plus packaging code "IM REEL" (5000 parts per reel).

<sup>3</sup>Grounding pin is used to provide a make-first/break-last condition when mating and unmating connector halves.

<sup>4</sup>Use turret TH502 (1-601967-6) with hand tool 601967-1.

<sup>5</sup>Use turret TH501 (1-601967-5) with hand tool 601967-1.

<sup>6</sup>Pin length is .630±.005 [16.002±.127] on these two pins.

<sup>7</sup>Die Set requires "C" Head Adapter Part No. 318161-1; Adapter Holder Part No. 356304-1 (with ratchet) or 189928-1 (without); and Power Unit Part No. 189721-2 (hand actuated) or 189722-2 (foot actuated).

<sup>\*</sup>Commercial PRO-CRIMPER II Hand Tool for field repair use only. **Note:** Die Set can be adapted for use with the 626 Pneumatic Tool System.

<sup>\*\*</sup>There are power options available for these tools/dies. See Battery Powered Crimp tool Kit and SDE Electric Terminator on page 30.

†Does not use Hand Tool 91539-1 or 601967-1.

‡Single contact, free-air test current is not to be construed as contact rating current. Use only for testing. Refer to contact current carrying capability information on page 8.

**Insertion Tool Part No. 200893-2** (for insulation diameters .070 [1.78] or less).

**Extraction Tool Part No. 305183.**

**Note:** All part numbers are RoHS compliant.

**Signal Contacts** (Continued)

**Size 20 DF, Crimp, Snap-In**

**Contact Size**—20  
**Pin Diameter**—.040 [1.02]  
 \*See Product Spec 108-40005



Pin



Socket

**Material**

**Pin Body**—Brass  
**Socket**—Phosphor bronze

**Contact Finish**

- A**—Select gold flash over nickel on entire contact, with additional .000030 [0.00076] gold on mating end
  - B**—Duplex plated .000030 [0.00076] gold on mating end, tin on termination end, with entire contact nickel underplated
  - C**—Gold flash over nickel on entire contact
  - D**—Duplex plated gold flash on mating end, tin on termination end, with entire contact nickel underplated
- Insertion/Extraction Tool **Part No. 91285-1**  
 Instruction Sheet—408-9404  
 This tool includes interchangeable tips to Insert/Extract:  
 Size 22, 28-22 AWG [0.08-0.03mm<sup>2</sup>] Crimp Contacts  
 Size 20, 28-20 AWG [0.08-0.6mm<sup>2</sup>] Crimp and Solder Cup Contacts  
 Size 20, Posted Contacts



Wire Size Range	Ins. Dia. Max.	Contact Finish Code	Contact Part Nos.				Tooling**		Color Code (Loose Piece)
			Pin		Socket		Strip Form Applicator††	Hand Tool	
			Strip Form	Loose Piece	Strip Form	Loose Piece			
28-24 AWG [0.08-0.2 mm <sup>2</sup> ]	1.02	A	66507-3♦	66507-9♦	66505-3♦	66505-9♦	466423-□††♦ or 466901-1††♦ or 1016015-1††♦	91503-1†♦	Blue Dot
		B	1658540-1♦	1658540-5♦	1658538-2♦	—			
		C	66507-4♦	1-66507-0♦	66505-4♦	1-66505-0♦			
		D	1658540-5♦	1658540-2♦	1658538-3♦	1658538-1♦			
26-22 AWG [0.12-0.4 mm <sup>2</sup> ]	1.27	A	66682-2♦	66682-4♦	66683-2♦	66683-4♦	466758-2††♦ or 466963-1††♦ or 567849-1††♦	91549-1†♦	Black Dot
		B	5066682-9♦	—	1-5066683-0♦	—			
		C	745254-3♦	745254-7♦	745253-3♦	745253-7♦			
		D	5066682-6♦	—	5066683-7♦	—			
24-20 AWG [0.2-0.6 mm <sup>2</sup> ]	1.52	A	66506-3♦	66506-9♦	66504-3♦	66504-9♦	466422-□††♦ or 466900-1††♦ or 567801-1††♦ or 1016002-1††♦	91503-1†♦	Red Dot
		B	1658539-1♦	1658539-3♦	1658537-3♦	1658537-4♦			
		C	66506-4♦	1-66506-0♦	66504-4♦	1-66504-0♦			
		D	1658539-2♦	1658539-4♦	1658537-1♦	1658537-2♦			

†To use with the 626 Pneumatic Tool System: remove the crimping head from the Straight Action Hand Tool (SAHT) Assembly, order SAHT Adapter **Part No. (Call Technical Support at 800-522-6752)**, Adapter Holder **Part No. 356304-1** (with ratchet) or **189928-1** (without), and Power Unit **Part No. 189721-1** (hand actuated) or **189722-1** (foot actuated).  
 ††For complete information on AMP Strip Form Applicators for fully automatic and semiautomatic machines, contact Technical Support: 1-800-522-6752.  
**Note:** Commercial PRO-CRIMPER II Maintenance and Repair Hand Tool for Wire Size 28-24 AWG [0.08-0.2mm<sup>2</sup>] (Ins. Dia. Max. .040 [1.02]), and Wire Size 24-20 AWG [0.2-0.6mm<sup>2</sup>] (Ins. Dia. Max. .060 [1.52])—**Part No. 58448-2**.  
**Note:** Die Set **Part No. 58448-3** can be adapted for use with the 626 Pneumatic Tool System.  
 \*\*There are power options available for these tools/dies. See Battery Powered Crimp tool Kit and SDE Electric Terminator on page 30.

**Note:** All part numbers are RoHS compliant except: ♦ Indicates non-RoHS compliant.

**Signal Contacts** (Continued)

**Size 20 DF, Crimp, Snap-In**  
(Continued)

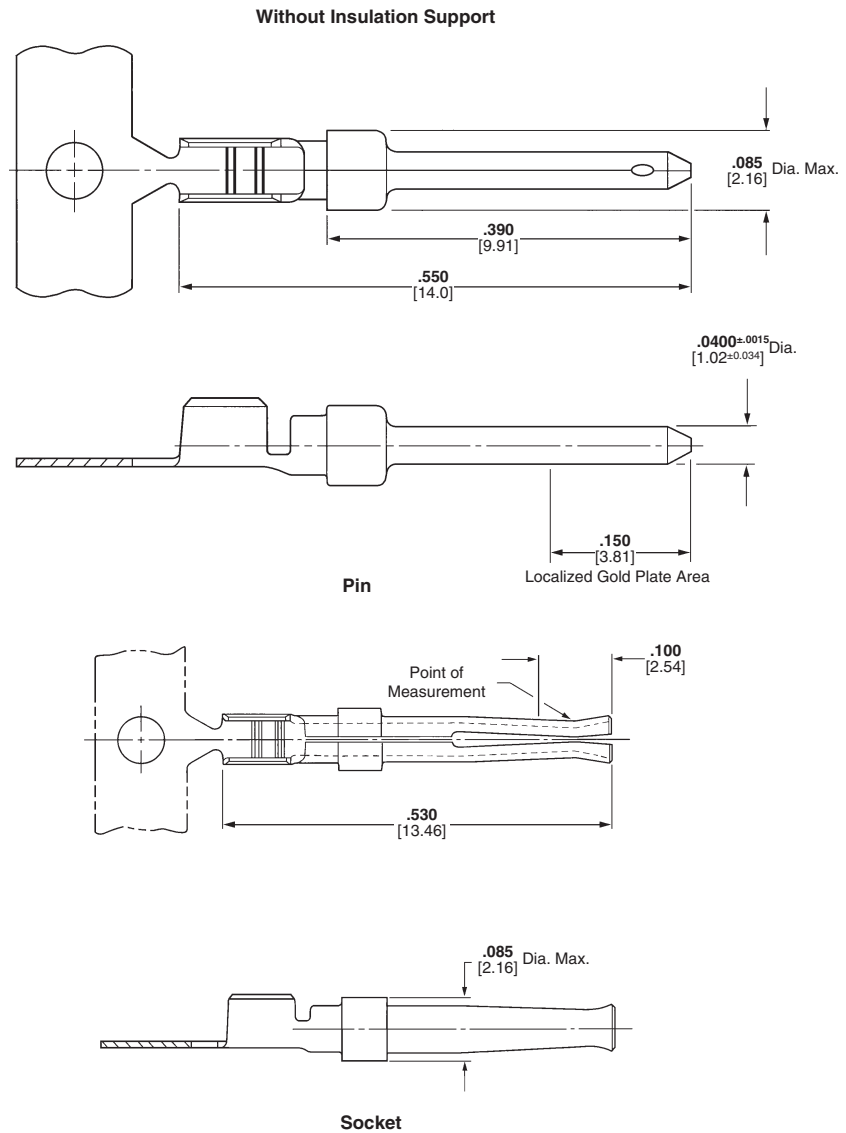
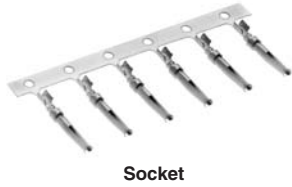
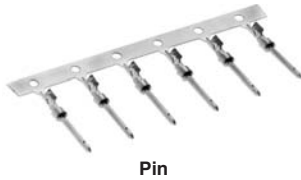

Wire Size Range	Ins. Dia. Max.	Contact Finish Code	Contact Part Nos.				Tooling**		Color Code (Loose Piece)
			Pin		Socket		Strip Form Applicator	Hand Tool	
			Strip Form	Loose Piece	Strip Form	Loose Piece			
28-24 AWG [0.08-0.2 mm <sup>2</sup> ]	.068 1.73	A	205310-2♦	—	205311-3♦	—	††	—	—
		C	—	—	—	—			
24-20 AWG [0.2-0.6 mm <sup>2</sup> ]	.068 1.73	A	205202-2♦	—	205201-3♦	205201-5♦	††	91548-1♦	Red Dot
		C	205202-6♦	205202-7♦	205201-6♦	205201-7♦			
22-18 AWG [0.4-0.8 mm <sup>2</sup> ]	.068 1.73	A	745229-2♦	745229-4♦	745230-2♦	745230-4♦	††	91513-1♦	Green Dot
		B	1-745229-1♦	—	1-745230-1♦	1-745230-3♦			
		C	745229-5♦	745229-7♦	745230-5♦	745230-7♦			
		D	—	—	745230-8♦	—			

††For complete information on AMP Strip Form Applicators for fully automatic and semiautomatic machines, contact Technical Support: 1-800-522-6752.

**Note:** Wire insulation diameter is limited by the connector housing cavity and clearance for the insertion/extraction tool.

\*\*There are power options available for these tools/dies. See Battery Powered Crimp tool Kit and SDE Electric Terminator on page 30.

**Note:** All part numbers are RoHS compliant except: ♦ Indicates non-RoHS compliant.



**Signal Contacts** (Continued)

**Size 20 DF, Solder, Snap-In**

Contact Size—20

\*See Product Spec 108-40005



Pin



Socket



Pin



Socket

**Material**

Pin—Brass

Socket—Phosphor bronze

**Contact Finish**

Gold flash over nickel on entire contact, with additional .000030 [0.00076] gold on mating end

Contacts to be soldered to wire before being inserted into housing.  
18 AWG [0.8-0.9 mm<sup>2</sup>] Max. Wire

Strip Form Contact No.		Loose Piece Contact No.	
Pin	Socket	Pin	Socket
66570-2	66569-2	66570-3	66569-3

Note: All part numbers are RoHS compliant.