

Cree® XLamp® ML-C LEDs



PRODUCT DESCRIPTION

The Cree XLamp ML-C LED brings lighting-class reliability and performance to 1/3-watt LEDs. The XLamp ML-C expands Cree’s lighting-class leadership to LED bulbs and linear and distributed lighting applications. With XLamp lighting-class reliability, a wide viewing angle, uniform light output, and industry-leading chromaticity binning in a 3.5-mm X 3.5-mm package, the XLamp ML-C LED continues Cree’s history of segment-focused product innovation in LEDs for lighting applications.

The XLamp ML-C LED brings high performance and a smooth look to a wide range of lighting applications, including linear lighting, fluorescent retrofits and retail-display lighting.

FEATURES

- Available in white (2,600 K to 8,300 K CCT) and 80-, 85- and 90-CRI minimum
- Available in both parallel and series
- ANSI-compatible sub-bins
- Maximum drive current: 350 mA for parallel, 175 mA for series
- 120° viewing angle, uniform chromaticity profile
- Electrically neutral thermal path
- RoHS and REACH-compliant
- Unlimited floor life at $\leq 30\text{ }^{\circ}\text{C}/85\%\text{ RH}$

TABLE OF CONTENTS

Flux Characteristics	2
Relative Spectral Power Distribution .4	
Relative Flux vs. Junction Temperature	5
Electrical Characteristics	5
Relative Flux vs. Current	6
Thermal Design	7
Typical Spatial Distribution.....	8
Reflow Soldering Characteristics	9
Notes.....	10
Mechanical Dimensions.....	11
Tape and Reel	12
Packaging.....	13

FLUX CHARACTERISTICS - ML-C PARALLEL ($T_j = 25\text{ }^\circ\text{C}$)

The following table provides several base order codes for XLamp ML-C LEDs. It is important to note that the base order codes listed here are a subset of the total available order codes for the product family. For more order codes, as well as a complete description of the order-code nomenclature, please consult the XLamp ML-C LED Binning and Labeling document.

Color	CCT Range		Base Order Codes Min. Luminous Flux (lm) @ 100 mA		Calculated Min. Luminous Flux (lm) @ 300 mA *	Order Code
	Min.	Max.	Group	Flux (lm)		
Cool White	5,000 K	8,300 K	J3	26.8	65.5	MLCAWT-A1-0000-000X51
			K2	30.6	74.7	MLCAWT-A1-0000-000051
80-CRI Cool White	6,000 K	7,000 K	J3	26.8	65.5	MLCAWT-H1-0000-000XE1
			K2	30.6	74.7	MLCAWT-H1-0000-0000E1
	4,750 K	5,250 K	J3	26.8	65.5	MLCAWT-H1-0000-000XE3
			K2	30.6	74.7	MLCAWT-H1-0000-0000E3
Warm White	3,700 K	4,300 K	J3	26.8	65.5	MLCAWT-A1-0000-000XE5
			K2	30.6	74.7	MLCAWT-A1-0000-0000E5
	2,800 K	3,200 K	J3	26.8	65.5	MLCAWT-A1-0000-000XE7
			K2	30.6	74.7	MLCAWT-A1-0000-0000E7
80-CRI Warm White	3,700 K	4,300 K	J3	26.8	65.5	MLCAWT-H1-0000-000XE5
	2,800 K	3,200 K	J2	23.5	57.4	MLCAWT-H1-0000-000WE7
85-CRI Warm White	3,700 K	4,300 K	J3	26.8	65.5	MLCAWT-P1-0000-000XE5
	2,800 K	3,200 K	J2	23.5	57.4	MLCAWT-P1-0000-000WE7
90-CRI Warm White	3,700 K	4,300 K	H0	18.1	44.2	MLCAWT-U1-0000-000VE5
	2,800 K	3,200 K	J2	23.5	57.4	MLCAWT-U1-0000-000WE7

Notes:

- Cree maintains a tolerance of $\pm 7\%$ on flux and power measurements, ± 0.005 on chromaticity (CCx, CCy) measurements and ± 2 on CRI measurements.
 - Typical CRI for Cool White (4,300 K – 8,300 K CCT) is 75.
 - Typical CRI for Warm White (2,600 K – 4,300 K CCT) is 80.
 - Minimum CRI for 80-CRI White is 80.
 - Minimum CRI for 85-CRI White is 85.
 - Minimum CRI for 90-CRI White is 90.
- * Calculated flux values are for reference only.

FLUX CHARACTERISTICS - ML-C SERIES (T_j = 25 °C)

The following table provides several base order codes for XLamp ML-C LEDs. It is important to note that the base order codes listed here are a subset of the total available order codes for the product family. For more order codes, as well as a complete description of the order-code nomenclature, please consult the XLamp ML-C LED Binning and Labeling document.

Color	CCT Range		Base Order Codes Min. Luminous Flux (lm) @ 50 mA		Calculated Min. Luminous Flux (lm) @ 150 mA *	Order Code
	Min.	Max.	Group	Flux (lm)		
Cool White	5,000 K	8,300 K	J3	26.8	65.5	MLCSWT-A1-0000-000X51
			K2	30.6	74.7	MLCSWT-A1-0000-000051
80-CRI Cool White	6,000 K	7,000 K	J3	26.8	65.5	MLCSWT-H1-0000-000XE1
			K2	30.6	74.7	MLCSWT-H1-0000-0000E1
	4,750 K	5,250 K	J3	26.8	65.5	MLCSWT-H1-0000-000XE3
			K2	30.6	74.7	MLCSWT-H1-0000-0000E3
Warm White	3,700 K	4,300 K	J3	26.8	65.5	MLCSWT-A1-0000-000XE5
			K2	30.6	74.7	MLCSWT-A1-0000-0000E5
	2,800 K	3,200 K	J3	26.8	65.5	MLCSWT-A1-0000-000XE7
			K2	30.6	74.7	MLCSWT-A1-0000-0000E7
80-CRI Warm White	3,700 K	4,300 K	J3	26.8	65.5	MLCSWT-H1-0000-000XE5
	2,800 K	3,200 K	J2	23.5	57.4	MLCSWT-H1-0000-000WE7
85-CRI Warm White	3,700 K	4,300 K	J3	26.8	65.5	MLCSWT-P1-0000-000XE5
	2,800 K	3,200 K	J2	23.5	57.4	MLCSWT-P1-0000-000WE7
90-CRI Warm White	3,700 K	4,300 K	H0	18.1	44.2	MLCSWT-U1-0000-000VE5
	2,800 K	3,200 K	J2	23.5	57.4	MLCSWT-U1-0000-000WE7

Notes:

- Cree maintains a tolerance of $\pm 7\%$ on flux and power measurements, ± 0.005 on chromaticity (CC_x, CC_y) measurements and ± 2 on CRI measurements.
- Typical CRI for Cool White (4,300 K – 8,300 K CCT) is 75.
- Typical CRI for Warm White (2,600 K – 4,300 K CCT) is 80.
- Minimum CRI for 80-CRI White is 80.
- Minimum CRI for 85-CRI White is 85.
- Minimum CRI for 90-CRI White is 90.
- * Calculated flux values are for reference only.

CHARACTERISTICS ($T_j = 25\text{ }^\circ\text{C}$)

Characteristics	Unit	Minimum	Typical	Maximum
Thermal resistance, junction to solder point	$^\circ\text{C}/\text{W}$		13	
Viewing angle (FWHM)	degrees		120	
Temperature coefficient of voltage - parallel	$\text{mV}/^\circ\text{C}$		-3.4	
Temperature coefficient of voltage - series	$\text{mV}/^\circ\text{C}$		-6.8	
ESD classification (HBM per Mil-Std-883D)			Class 2	
DC forward current - parallel	mA			350
DC forward current - series	mA			175
Reverse voltage	V			-5
Forward voltage (@ 100 mA) - parallel	V		3.2	
Forward voltage (@ 50 mA) - series	V		6.4	
LED junction temperature	$^\circ\text{C}$			150

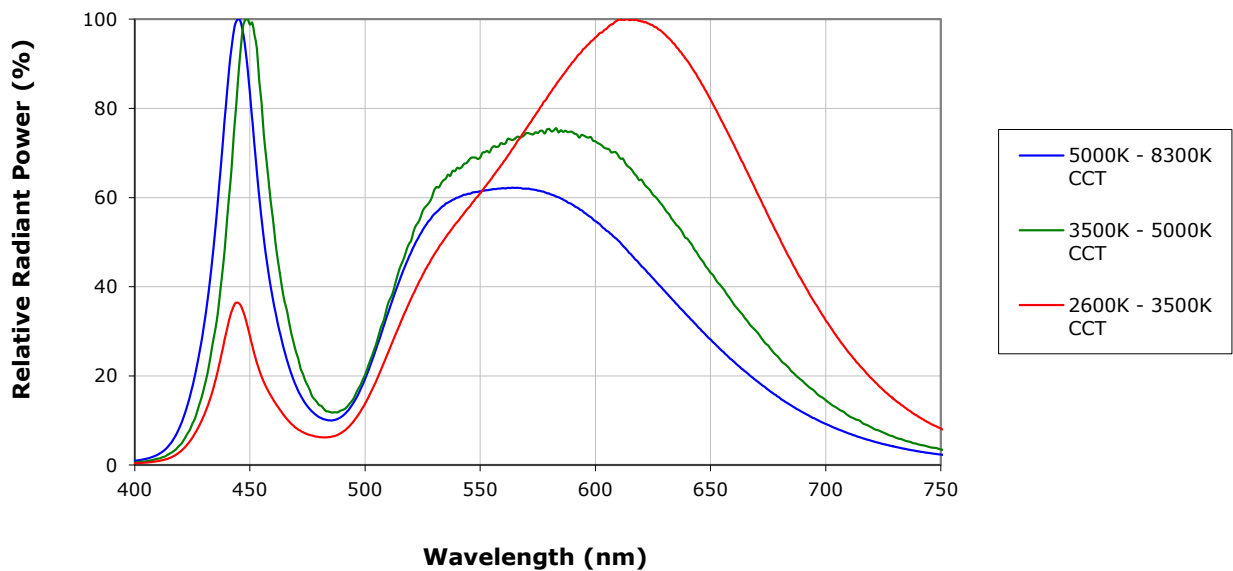
RELATIVE SPECTRAL POWER DISTRIBUTION

RELATIVE FLUX VS. JUNCTION TEMPERATURE ($I_F = 100$ mA, ML-C PARALLEL, $I_F = 50$ mA, ML-C SERIES)

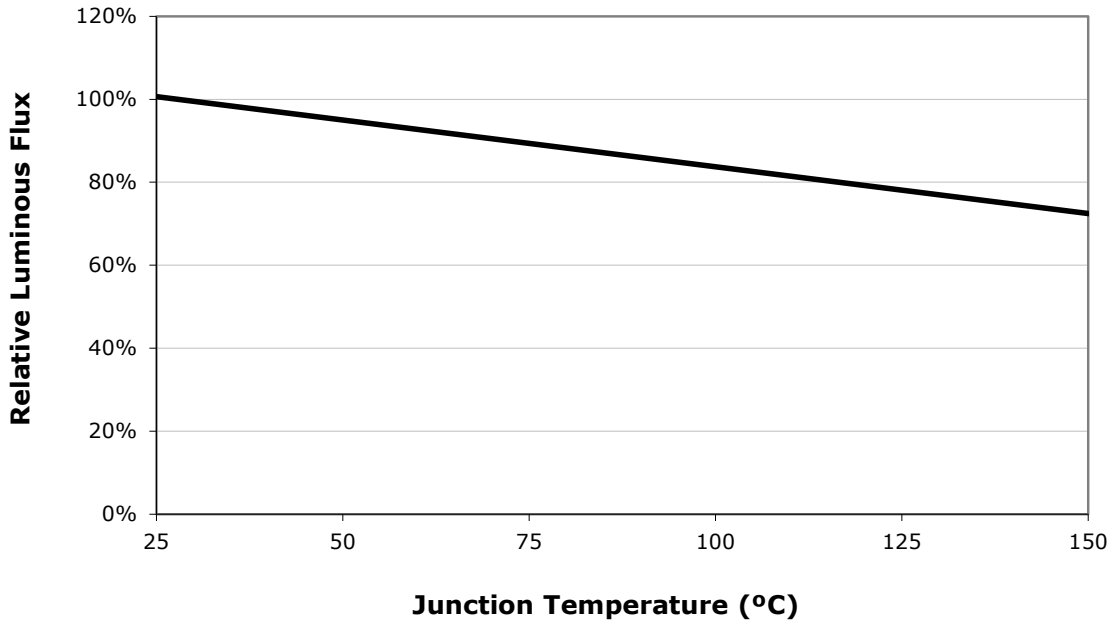

ELECTRICAL CHARACTERISTICS - ML-C PARALLEL ($T_j = 25$ °C)

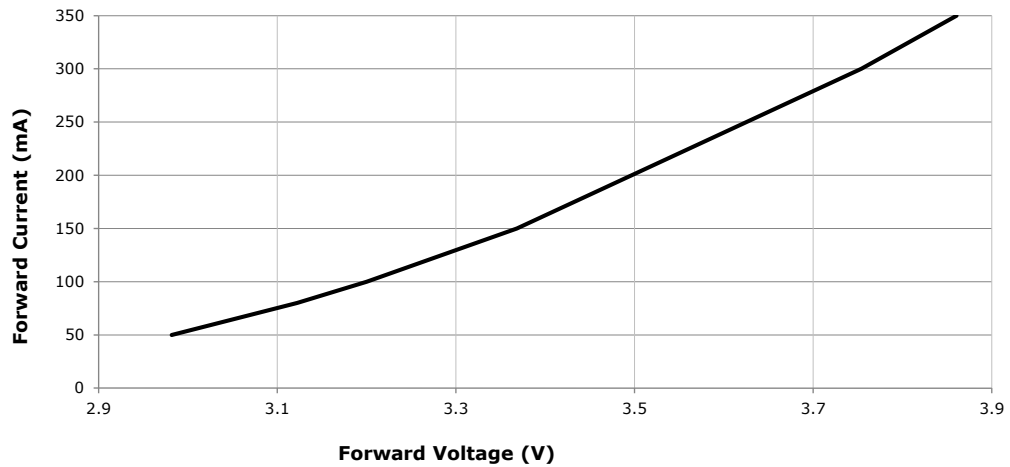

ELECTRICAL CHARACTERISTICS - ML-C SERIES ($T_j = 25\text{ }^\circ\text{C}$)

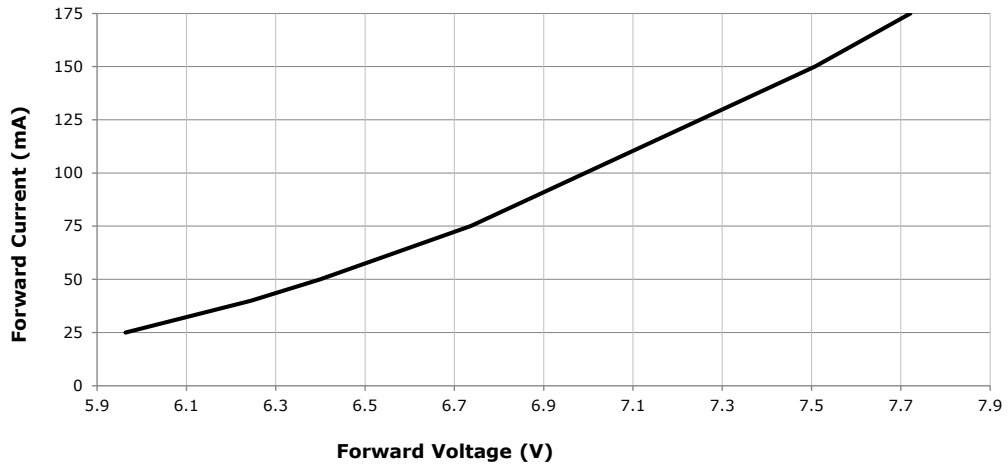

RELATIVE FLUX VS. CURRENT - ML-C PARALLEL ($T_j = 25\text{ }^\circ\text{C}$)

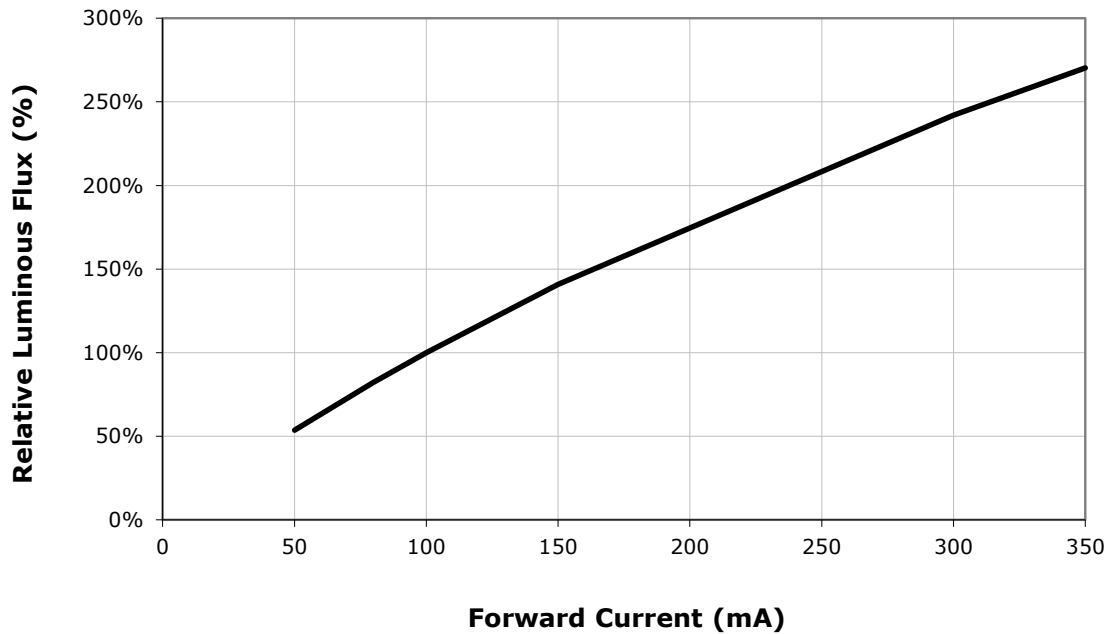

RELATIVE FLUX VS. CURRENT - ML-C SERIES ($T_j = 25\text{ }^\circ\text{C}$)

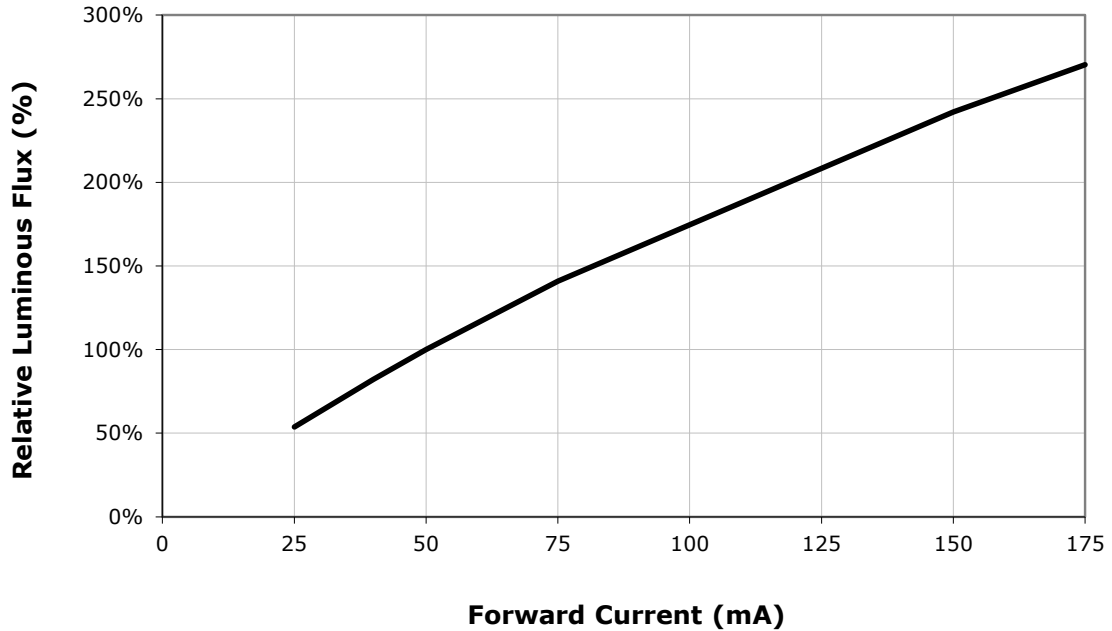

THERMAL DESIGN - ML-C PARALLEL

The maximum forward current is determined by the thermal resistance between the LED junction and ambient. It is crucial for the end product to be designed in a manner that minimizes the thermal resistance from the solder point to ambient in order to optimize lamp life and optical characteristics.

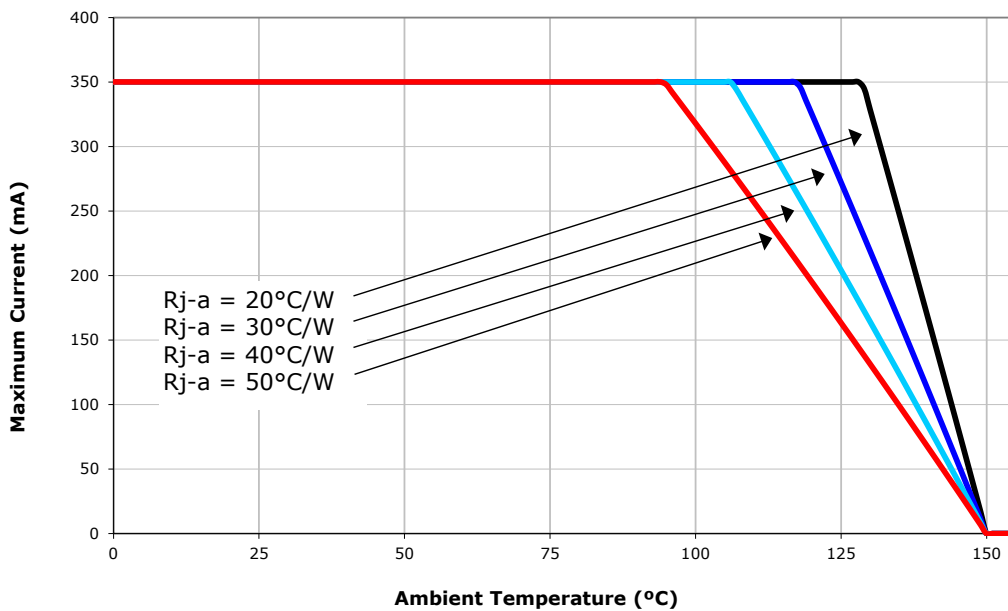

THERMAL DESIGN - ML-C SERIES

The maximum forward current is determined by the thermal resistance between the LED junction and ambient. It is crucial for the end product to be designed in a manner that minimizes the thermal resistance from the solder point to ambient in order to optimize lamp life and optical characteristics.

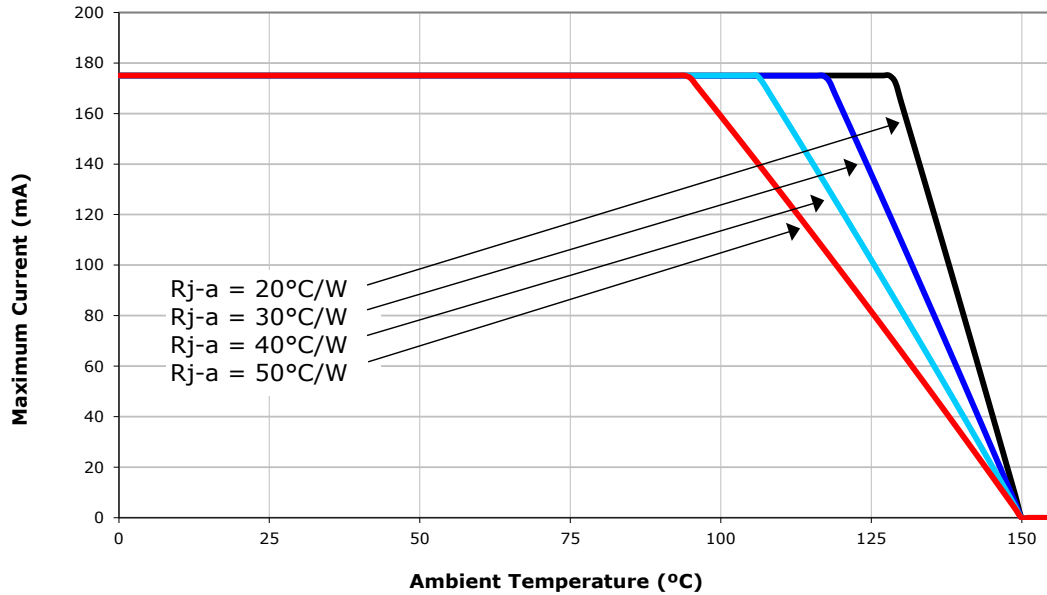

TYPICAL SPATIAL DISTRIBUTION

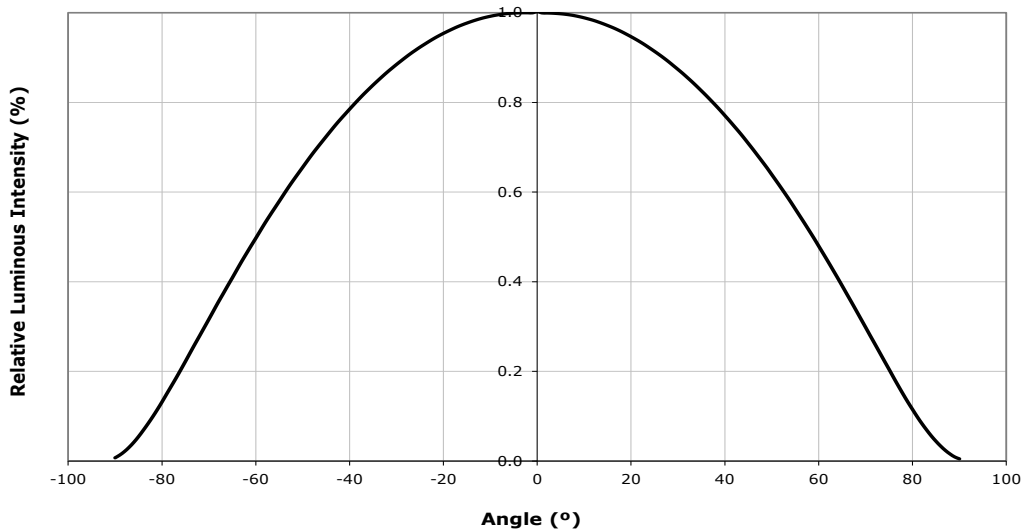

REFLOW SOLDERING CHARACTERISTICS

In testing, Cree has found XLamp ML-C LEDs to be compatible with JEDEC J-STD-020C, using the parameters listed below. As a general guideline, Cree recommends that users follow the recommended soldering profile provided by the manufacturer of solder paste used.

Note that this general guideline may not apply to all PCB designs and configurations of reflow soldering equipment.

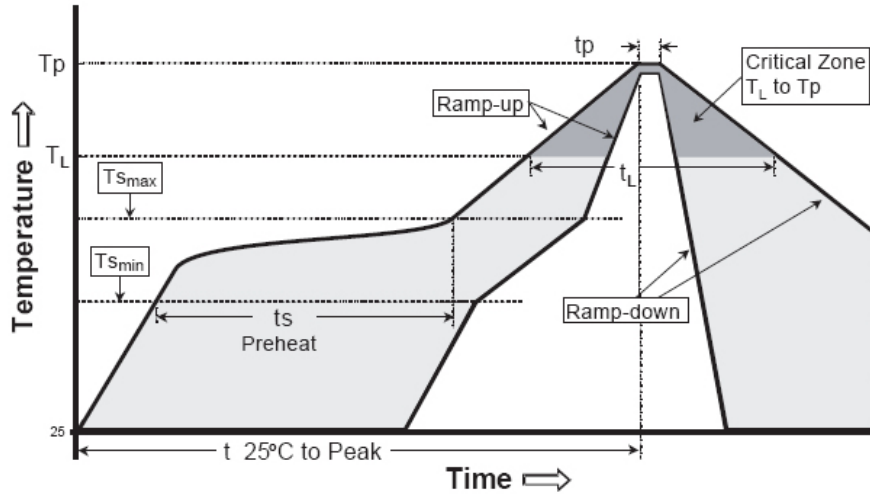

Profile Feature	Lead-Based Solder	Lead-Free Solder
Average Ramp-Up Rate ($T_{S_{max}}$ to T_p)	3 °C/second max.	3 °C/second max.
Preheat: Temperature Min ($T_{S_{min}}$)	100 °C	150 °C
Preheat: Temperature Max ($T_{S_{max}}$)	150 °C	200 °C
Preheat: Time ($t_{s_{min}}$ to $t_{s_{max}}$)	60-120 seconds	60-180 seconds
Time Maintained Above: Temperature (T_L)	183 °C	217 °C
Time Maintained Above: Time (t_L)	60-150 seconds	60-150 seconds
Peak/Classification Temperature (T_p)	215 °C	260 °C
Time Within 5 °C of Actual Peak Temperature (t_p)	10-30 seconds	20-40 seconds
Ramp-Down Rate	6 °C/second max.	6 °C/second max.
Time 25 °C to Peak Temperature	6 minutes max.	8 minutes max.

Note: All temperatures refer to topside of the package, measured on the package body surface.

Note: While the high reflow temperatures (above) have been approved, Cree’s best practice guideline for reflow is to use as low a temperature as possible during the reflow soldering process for these LEDs.

NOTES

Lumen Maintenance Projections

Cree now uses standardized IES LM-80-08 and TM-21-11 methods for collecting long-term data and extrapolating LED lumen maintenance. For information on the specific LM-80 data sets available for this LED, refer to the public LM-80 results document at www.cree.com/~media/Files/Cree/LED%20Components%20and%20Modules/XLamp/XLamp%20Application%20Notes/LM80_Results.pdf.

Cree currently recommends a maximum drive current of 117 mA for XLamp ML-C parallel and 58 mA for XLamp ML-C series LEDs in designs seeking the ENERGY STAR®* 35,000-hour lifetime rating ($\geq 94.1\%$ luminous flux @ 6000 hours) or 25,000-hour lifetime rating ($\geq 91.8\%$ luminous flux @ 6000 hours).

Please read the XLamp Long-Term Lumen Maintenance application note for more details on Cree's lumen maintenance testing and forecasting. Please read the XLamp Thermal Management application note for details on how thermal design, ambient temperature, and drive current affect the LED junction temperature.

* These lifetime ratings are based on the current ENERGY STAR Product Specification for Luminaires (Light Fixtures) V1.0 (February 16, 2011) and ENERGY STAR Program Requirements for Integral LED Lamps V1.4 (May 13, 2011) lumen maintenance criteria.

Moisture Sensitivity

In testing, Cree has found XLamp ML-C LEDs to have unlimited floor life in conditions $\leq 30\text{ }^{\circ}\text{C}/85\%$ relative humidity (RH). Moisture testing included a 168-hour soak at $85\text{ }^{\circ}\text{C}/85\%$ RH followed by 3 reflow cycles, with visual and electrical inspections at each stage.

Cree recommends keeping XLamp LEDs in their sealed moisture-barrier packaging until immediately prior to use. Cree also recommends returning any unused LEDs to the resealable moisture-barrier bag and closing the bag immediately after use.

RoHS Compliance

The levels of environmentally sensitive, persistent biologically toxic (PBT), persistent organic pollutants (POP), or otherwise restricted materials in this product are below the maximum concentration values (also referred to as the threshold limits) permitted for such substances, or are used in an exempted application, in accordance with EU Directive 2002/95/EC on the restriction of the use of certain hazardous substances in electrical and electronic equipment (RoHS), as amended through April 21, 2006.

Vision Advisory Claim

WARNING. Do not look at exposed LED lamps in operation. Eye injury can result. For more information about LEDs and eye safety, please refer to the Cree LED Eye Safety Application Note (www.cree.com/~media/Files/Cree/LED%20Components%20and%20Modules/XLamp/XLamp%20Application%20Notes/XLamp_EyeSafety.pdf).

MECHANICAL DIMENSIONS (T_A = 25 °C)

All measurements are ±.13 mm unless otherwise indicated.

Top View

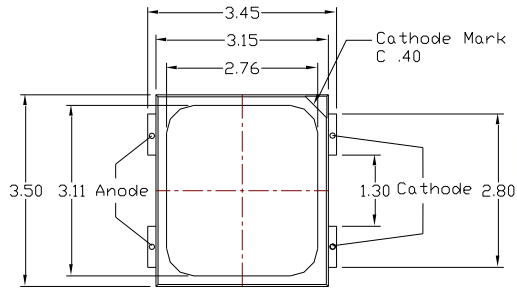
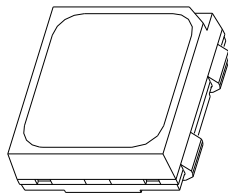

Top View

Bottom View

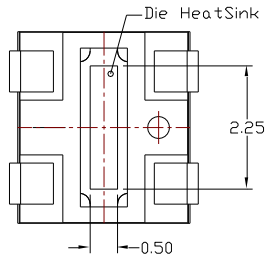

Side View

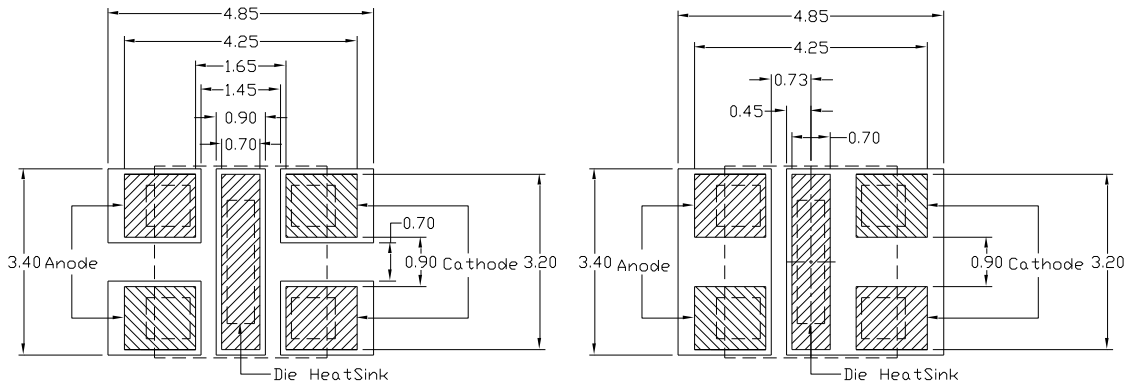
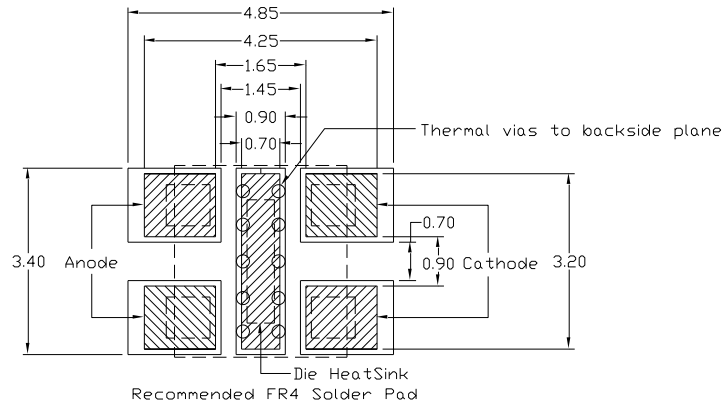
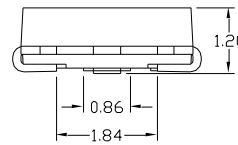

Recommended MCPCB Solder Pad

Alternative Solder Pad

TAPE AND REEL

All Cree carrier tapes conform to EIA-481D, Automated Component Handling Systems Standard.

All dimensions in mm.

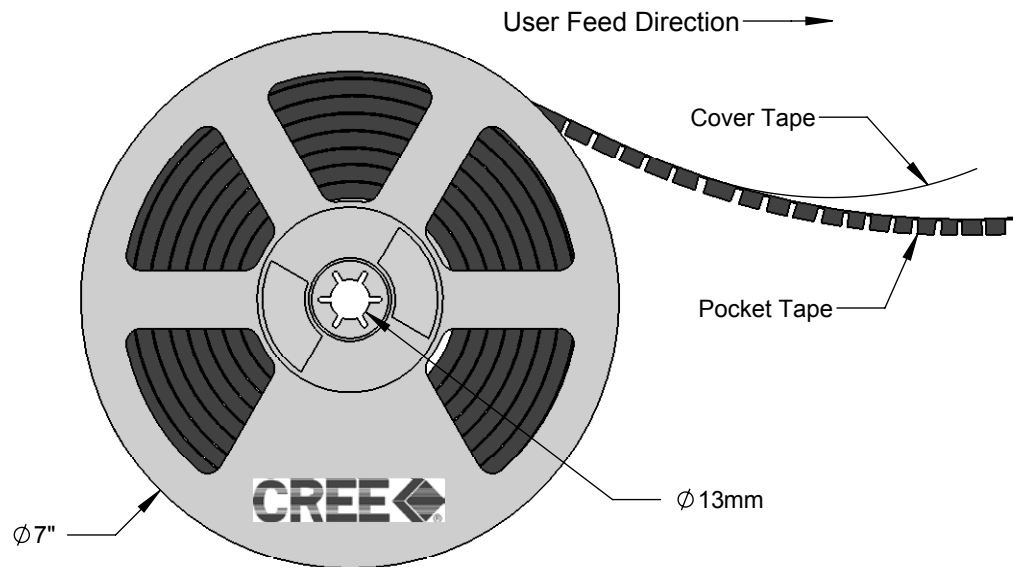
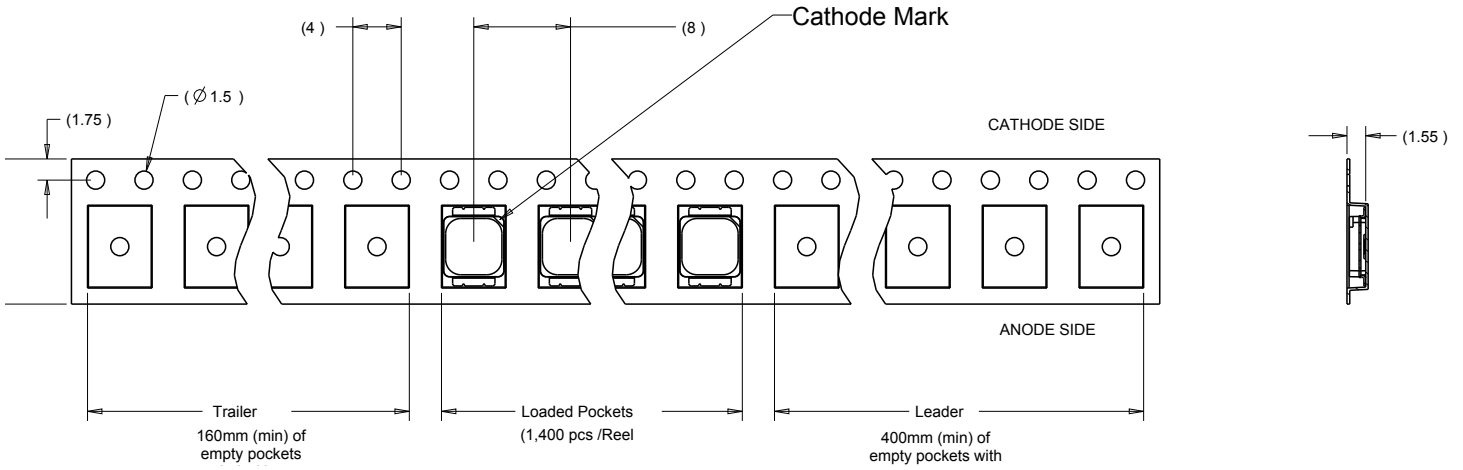

PACKAGING

All dimensions in mm.

