

LUXEON Rebel  
Illumination Portfolio

*Optimized  
solutions for  
illumination applications*

Technical Datasheet DS63

L U X E N<sup>®</sup>  
never before possible



# LUXEON<sup>®</sup> Rebel

## Illumination Portfolio

ANSI Binned with Minimum CRI

### Introduction

The LUXEON<sup>®</sup> Rebel Illumination Portfolio emitters in this datasheet deliver optimized combinations of light quality and light output needed for today's lighting applications. In addition to delivering specified Correlated Color Temperature and Color Rendering combinations, these parts deliver the efficacy, lifetime and reliability that all LUXEON Rebel LEDs are renowned for. This document contains the performance data needed to design and engineer LUXEON Rebel based applications.

### LUXEON Rebel Illumination Portfolio Products

- Specified CCT & CRI combinations
- ANSI compliant Quarter and Micro binning
- Exceed ENERGY STAR<sup>®</sup> lumen maintenance requirements
- High efficacy for sustainable design
- More light delivered at operating temperature
- Recognized under the Component Recognition Program of Underwriters Laboratories Inc. UL listing E327436.

**PHILIPS**  
**LUMILEDS**

# Table of Contents

Product Nomenclature.....	3
Environmental Compliance.....	3
Product Selection.....	4
Optical Characteristics.....	5
Electrical Characteristics.....	6
Absolute Maximum Ratings.....	8
JEDEC Moisture Sensitivity.....	8
Reflow Soldering Characteristics.....	9
Mechanical Dimensions.....	10
Pad Configuration.....	11
Solder Pad Design.....	11
Relative Spectral Distribution vs. Wavelength Characteristics.....	12
Light Output Characteristics over Temperature.....	17
Typical Forward Current Characteristics.....	19
Current Derating Curves.....	20
Typical Radiation Patterns.....	21
Emitter Pocket Tape Packaging.....	23
Emitter Reel Packaging.....	24
Product Binning and Labeling.....	25
LUXEON Rebel ANSI 1/16 <sup>th</sup> Micro Bin Structure.....	26
LUXEON Rebel ANSI 1/4 <sup>th</sup> Quadrant Bin Structure.....	27
LUXEON Rebel ANSI 1/16 <sup>th</sup> Micro Bin Coordinates.....	28
LUXEON Rebel ANSI 1/4 <sup>th</sup> Quadrant Bin Coordinates.....	29
Forward Voltage Bins.....	31

## Product Nomenclature

LUXEON Rebel is tested and binned at 350 mA, with current pulse duration of 20 ms. All characteristic charts where the thermal pad is kept at constant temperature (25°C typically) are measured with current pulse duration of 20 ms.

The LUXEON Rebel Illumination Portfolio is a series of power LED emitters designed for illumination.

The part number designation for the LXML and LXM3 series is explained as follows:

L X M L - A B C D and L X M 3 - A B C D

Where:

- A — designates radiation pattern (value P for Lambertian)
- B — designates color (W for White)
- C — designates nominal CCT
- D — designates test current (value I for 350 mA)

The part number designation for the LXM8 series is explained as follows:

L X M A - B C D E

Where:

- A — designates minimum CRI performance (value 8 = 80 minimum)
- B — designates radiation pattern (value P = Lambertian)
- C — designates color (value W = White)
- D & E — designates nominal ANSI CCT (value 27 = 2700K, 30 = 3000K)

Therefore products tested and binned at 350 mA follow the part numbering schemes:

L X M L - P x x I, L X M 3 - P x x I and L X M x - P W x x

## Average Lumen Maintenance Characteristics

Lumen maintenance for solid-state lighting devices (LEDs) is typically defined in terms of the percentage of initial light output remaining after a specified period of time. Philips Lumileds projects that LUXEON Rebel products will deliver, on average, 70% lumen maintenance (L70) at 50,000 hours of operation at a forward current of up to 700 mA. This projection is based on constant current operation with junction temperature maintained at or below 135°C. This performance is based on independent test data, Philips Lumileds historical data from tests run on similar material systems, and internal LUXEON reliability testing. Observation of design limits included in this data sheet is required in order to achieve this projected lumen maintenance.

## Environmental Compliance

Philips Lumileds is committed to providing environmentally friendly products to the solid-state lighting market. LUXEON Rebel is compliant to the European Union directives on the restriction of hazardous substances in electronic equipment, namely REACH and the RoHS directive. Philips Lumileds will not intentionally add the following restricted materials to the LUXEON Rebel: lead, mercury, cadmium, hexavalent chromium, polybrominated biphenyls (PBB) or polybrominated diphenyl ethers (PBDE).

# Product Selection

## Product Selection for LUXEON Rebel Thermal Pad Temperature = 25°C

Table 1.

Nominal CCT	Part Number	Minimum CRI	Typical CRI	Typical R9	Minimum Luminous Flux (lm) $\Phi_v$	Typical Luminous Flux $\Phi_v$
2700K	LXM3-PW8I	80	85	18	65	73
2700K	LXM8-PW27	80	85	15	70	80
3000K	LXM8-PW30	80	85	15	75	85
3000K	LXM3-PW7I	80	85	22	66	77
3000K	LXML-PW7I	85	90		50	66
3500K	LXM3-PW6I	80	85	30	67	80
4000K	LXML-PW5I	60	70		90	105
4000K	LXM3-PW5I	80	85	28	75	85
5000K	LXML-PW3I	65	70		90	105
5700K	LXML-PW2I	65	70		90	105
6500K	LXML-PW1I	65	70		90	105

### Notes for Table 1:

1. Philips Lumileds maintains a tolerance of  $\pm 6.5\%$  on luminous flux and  $\pm 2$  on CRI measurements.
2. LUXEON Rebel products with higher performance levels will become available in the future. Please consult Philips Lumileds or Future Lighting Solutions for more information.
3. Test current is 350 mA for all LXML-PxxI, LXM3-PxxI and LXMx-PWxx products.

# Optical Characteristics

## LUXEON Rebel at Test Current <sup>[1]</sup> Thermal Pad Temperature = 25°C

**Table 2.**

Nominal CCT	Color Temperature <sup>[2]</sup> CCT			Typical Total Included Angle <sup>[3]</sup> (degrees) $\nu_{0.90V}$	Typical Viewing Angle <sup>[4]</sup> (degrees) $2\alpha_{1/2}$
	Min.	Typ.	Max.		
2700K	2580K	2725K	2870K	160	120
3000K	2870K	3045K	3220K	160	120
3000K	2870K	3045K	3220K	160	120
3500K	3220K	3465K	3710K	160	120
4000K	3710K	3985K	4260K	160	120
4000K	3710K	3985K	4260K	160	120
5000K	4745K	5028K	5311K	160	120
5700K	5310K	5665K	6020K	160	120
6500K	6020K	6530K	7040K	160	120

**Notes for Table 2:**

1. Test current is 350 mA for all LXML-PxxI, LXM3-PxxI and LXMx-PWxx products.
2. CCT  $\pm 5\%$  tester tolerance.
3. Total angle at which 90% of total luminous flux is captured.
4. Viewing angle is the off axis angle from lamp centerline where the luminous intensity is  $\frac{1}{2}$  of the peak value.
5. All white products are built with Indium Gallium Nitride (InGaN).

# Electrical Characteristics

## Electrical Characteristics at 350 mA for LUXEON Rebel Thermal Pad Temperature = 25°C

**Table 3.**

Part Numbers	Forward Voltage $V_f$ [1] (V)			Typical Temperature Coefficient of Forward Voltage [2] (mV/°C) $\Delta V_f / \Delta T_j$	Typical Thermal Resistance Junction to Thermal Pad (°C/W) $R\theta_{j-c}$
	Min.	Typ.	Max.		
LXM3-PW8I	2.55	3.00	3.99	-2.0 to -4.0	10
LXM3-PW7I	2.55	3.00	3.99	-2.0 to -4.0	10
LXML-PW7I	2.55	3.00	3.99	-2.0 to -4.0	10
LXM3-PW6I	2.55	3.00	3.99	-2.0 to -4.0	10
LXM3-PW5I	2.55	3.00	3.99	-2.0 to -4.0	10
LXML-PW5I	2.55	3.00	3.99	-2.0 to -4.0	10
LXML-PW3I	2.55	3.00	3.99	-2.0 to -4.0	10
LXML-PW2I	2.55	3.00	3.99	-2.0 to -4.0	10
LXML-PW1I	2.55	3.00	3.99	-2.0 to -4.0	10
LXM8-PW27	2.50	3.00	3.50	-2.0 to -4.0	10
LXM8-PW30	2.50	3.00	3.50	-2.0 to -4.0	10

**Notes for Table 3:**

1. Philips Lumileds maintains a tolerance of  $\pm 0.06V$  on forward voltage measurements.
  2. Measured between  $25^\circ C = T_j = 110^\circ C$  at  $I_f = 350$  mA.
- \* Dynamic resistance is the inverse of the slope in linear forward voltage model for LEDs. See Figure 16.

## Typical Electrical Characteristics at 700 mA for LUXEON Rebel Thermal Pad Temperature = 25°C

**Table 4.**

Part Numbers	Typical Forward Voltage $V_f$ (V)
LXM3-PW8I	3.20
LXM8-PW27	3.20
LXM3-PW7I	3.20
LXML-PW7I	3.20
LXM8-PW30	3.20
LXM3-PW6I	3.20
LXM3-PW5I	3.20
LXML-PW5I	3.20
LXML-PW3I	3.20
LXML-PW2I	3.20
LXML-PW1I	3.20

**Notes for Table 4:**

- I. Philips Lumileds maintains a tolerance of  $\pm 0.06V$  on forward voltage measurements.

## Absolute Maximum Ratings

Table 5.

Parameter	Maximum Performance
DC Forward Current (mA) <sup>[3]</sup>	700
Peak Pulsed Forward Current (mA) <sup>[3]</sup>	700
Average Forward Current (mA) <sup>[3]</sup>	700
ESD Sensitivity	< 8000V Human Body Model (HBM) Class 3A JESD22-A114-E < 400V Machine Model (MM) Class B JESD22-A115-B
LED Junction Temperature <sup>[1] [3]</sup>	135°C
Operating Case Temperature at 350 mA	-40°C - 135°C
Storage Temperature	-40°C - 135°C
Soldering Temperature	JEDEC 020c 260°C
Allowable Reflow Cycles	3
Autoclave Conditions	121°C at 2 ATM 100% Relative Humidity for 96 Hours Maximum
Reverse Voltage (Vr)	See Note 2

Notes for Table 5:

1. Proper current derating must be observed to maintain junction temperature below the maximum.
2. LUXEON Rebel LEDs are not designed to be driven in reverse bias.
3. Maximum Ratings of 1000 mA forward drive current or LED junction temperature of 150°C can be applied for device operation not to exceed 60 seconds.

## JEDEC Moisture Sensitivity

Table 6.

Level	Floor Life		Soak Requirements	
	Time	Conditions	Standard	
			Time	Conditions
1	unlimited	[ 30°C / 85% RH	168h + 5 / -0	85°C / 85% RH



# Reflow Soldering Characteristics

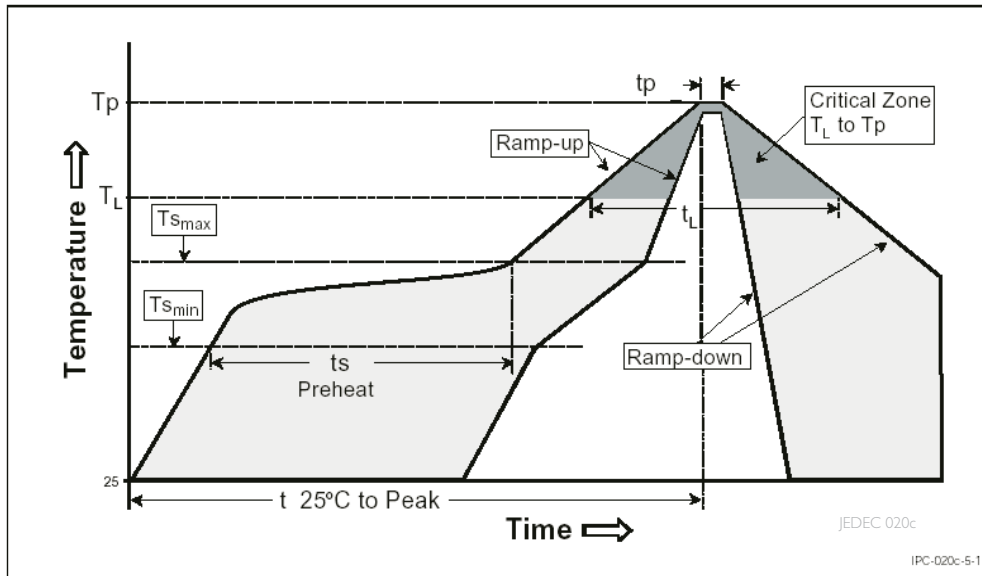

Temperature Profile for Table 7.

Table 7.

Profile Feature	Lead Free Assembly
Average Ramp-Up Rate ( $T_{s_{max}}$ to $T_p$ )	3°C / second max
Preheat Temperature Min ( $T_{s_{min}}$ )	150°C
Preheat Temperature Max ( $T_{s_{max}}$ )	200°C
Preheat Time ( $t_{s_{min}}$ to $t_{s_{max}}$ )	60 - 180 seconds
Temperature ( $T_L$ )	217°C
Time Maintained Above Temperature $T_L$ ( $t_L$ )	60 - 150 seconds
Peak / Classification Temperature ( $T_p$ )	260°C
Time Within 5°C of Actual Peak Temperature ( $t_p$ )	20 - 40 seconds
Ramp - Down Rate	6°C / second max
Time 25°C to Peak Temperature	8 minutes max

Notes for Table 7:

- I. All temperatures refer to the application Printed Circuit Board (PCB), measured on the surface adjacent to the package body.

# Mechanical Dimensions

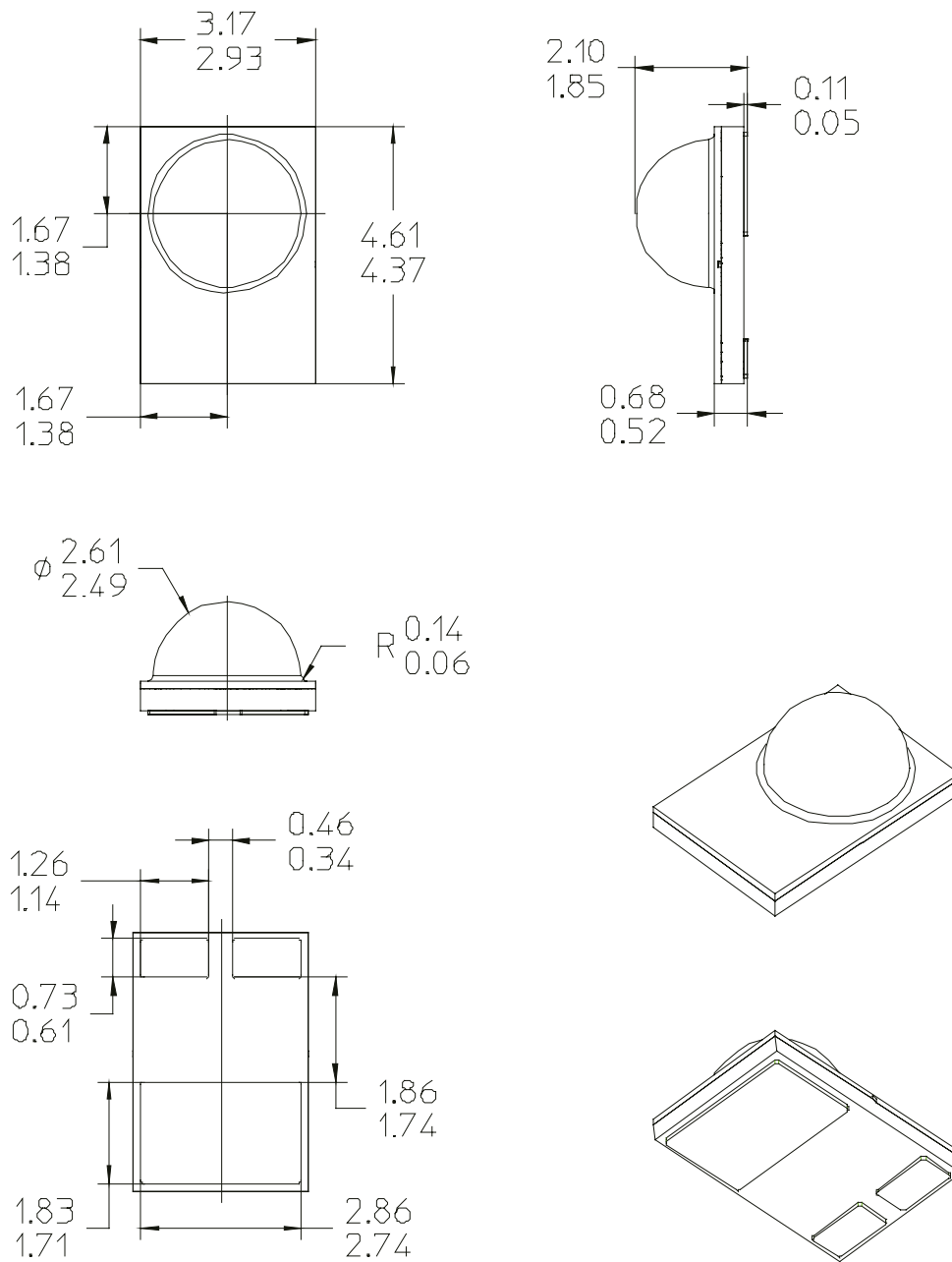
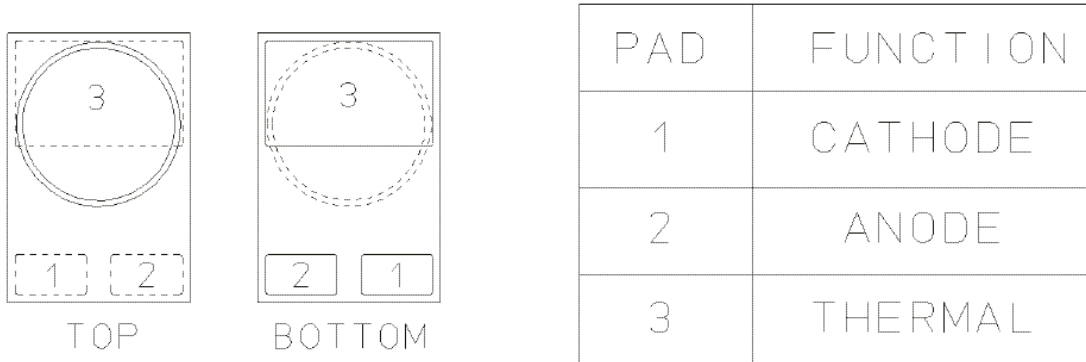

**Figure 1. Package outline drawing.**

Notes for Figure 1:

1. Do not handle the device by the lens—care must be taken to avoid damage to the lens or the interior of the device that can be damaged by excessive force to the lens.
2. Drawings not to scale.
3. All dimensions are in millimeters.
4. The thermal pad is electrically isolated from the anode and cathode contact pads.

## Pad Configuration

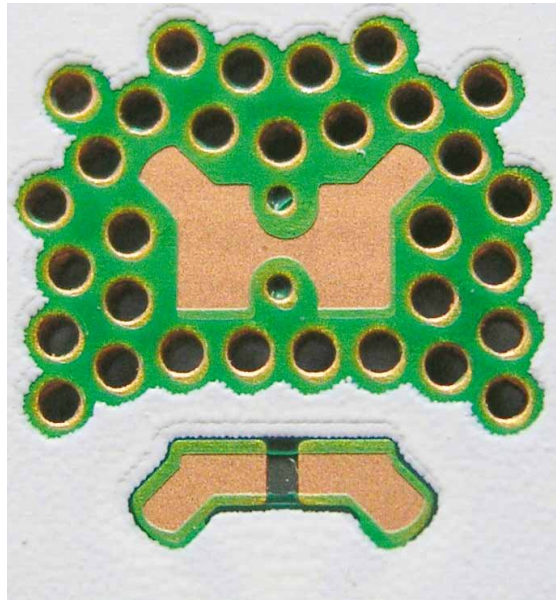

**Figure 2. Pad configuration.**

Note for Figure 2:

- I. The thermal pad is electrically isolated from the anode and cathode contact pads.

## Solder Pad Design



**Figure 3. Solder pad layout.**

Note for Figure 3:

The photograph below shows the recommended LUXEON Rebel layout on Printed Circuit Board (PCB). This design easily achieves a thermal resistance of 7 K/W.

Application Brief AB32 provides extensive details for this layout. In addition, the .dwg files are available at [www.philipslumileds.com](http://www.philipslumileds.com).

# Relative Spectral Distribution vs. Wavelength Characteristics

LXM8-PW27 (2700K) at Test Current, Thermal Pad Temperature = 25°C

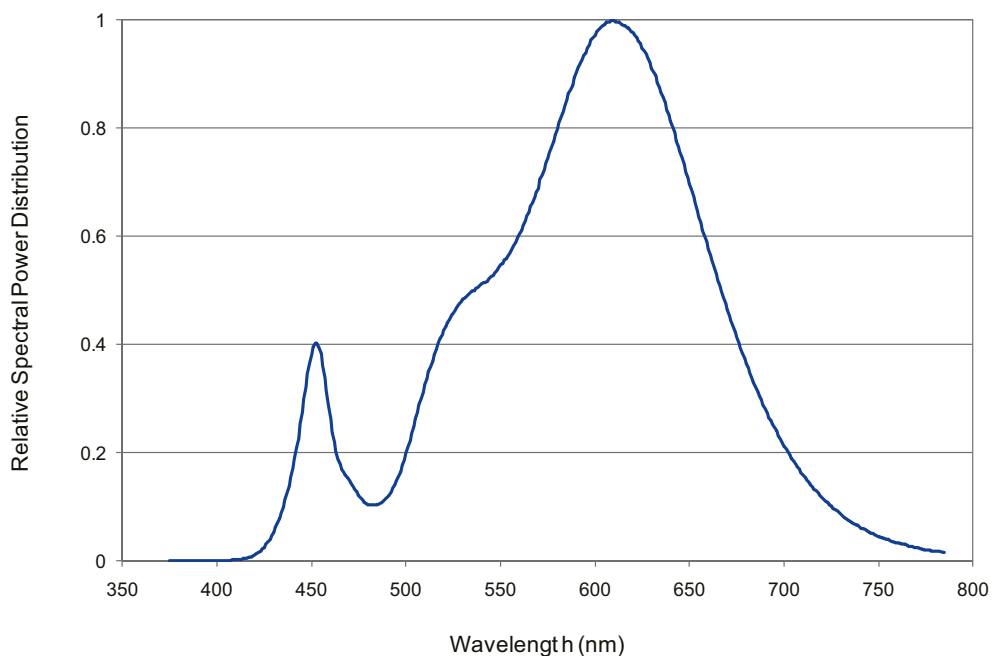

Figure 4. Color spectrum of LXM8-PW27 emitter, integrated measurement.

LXM3-PW81 (2700K) at Test Current, Thermal Pad Temperature = 25°C

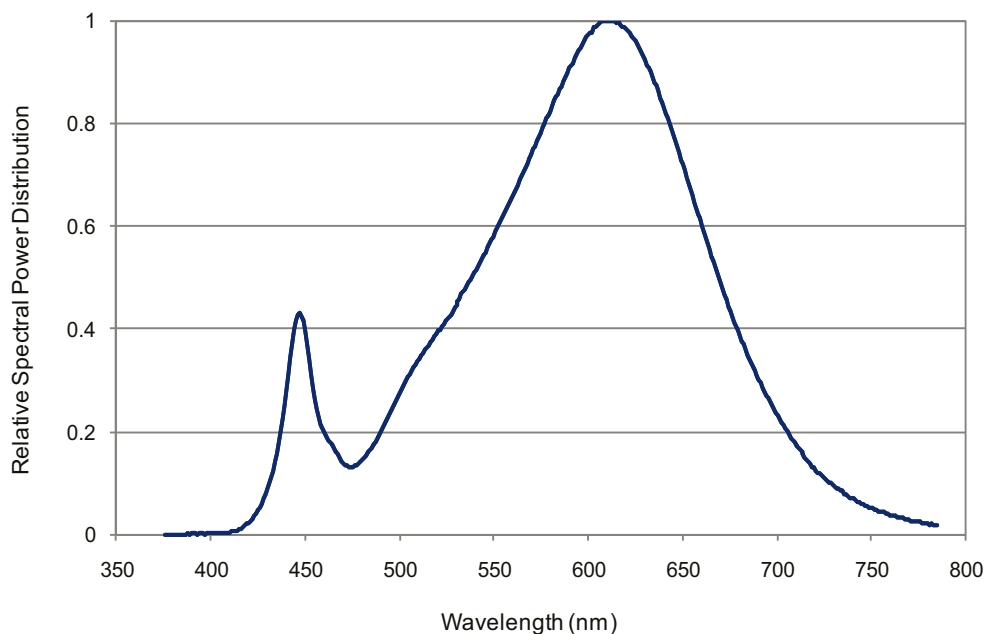

Figure 5. Color spectrum of LXM3-PW81 emitter, integrated measurement.

# Relative Spectral Distribution vs. Wavelength Characteristics, Continued

LXM3-PW71 (3000K) at Test Current, Thermal Pad Temperature = 25°C

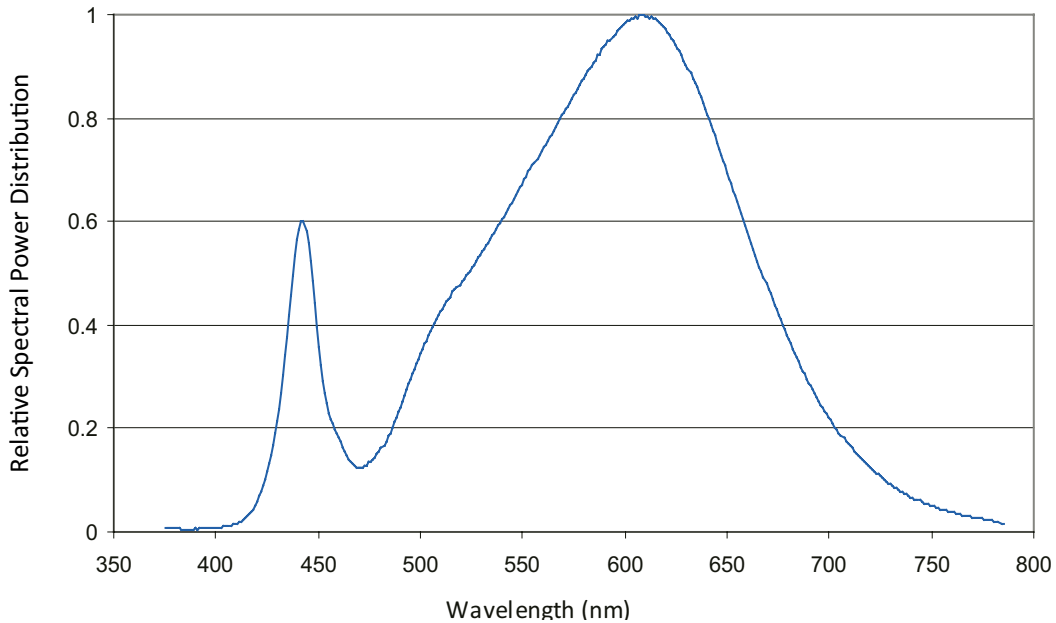

Figure 6. Color spectrum of LXM3-PW71 emitter, integrated measurement.

LXML-PW71 (3000K) at Test Current, Thermal Pad Temperature = 25°C

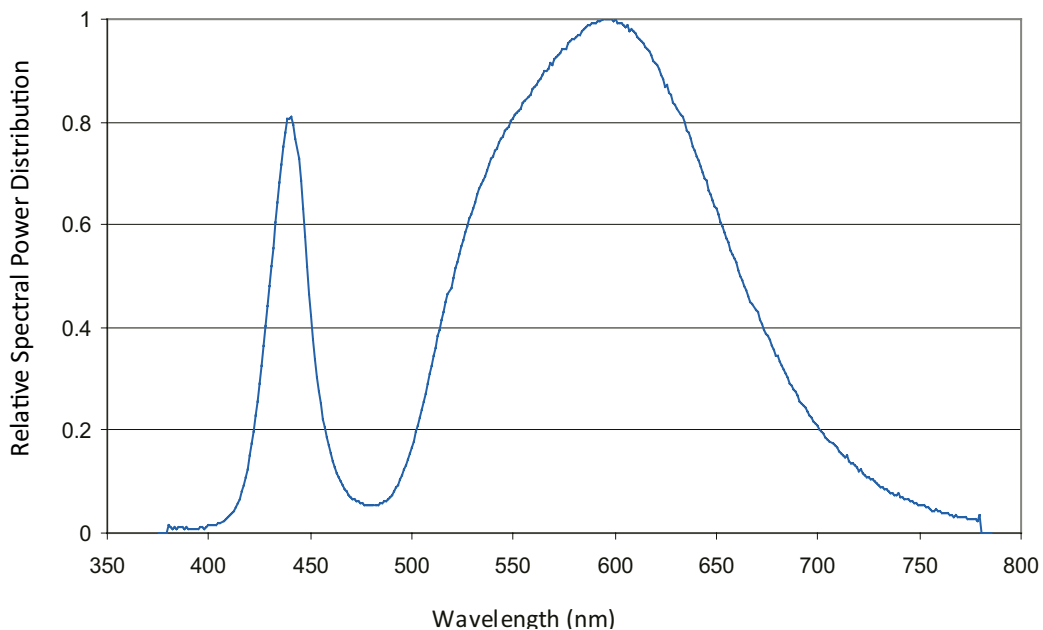

Figure 7. Color spectrum of LXML-PW71 emitter, integrated measurement.

# Relative Spectral Distribution vs. Wavelength Characteristics, Continued

LXM8-PW30 (3000K) at Test Current, Thermal Pad Temperature = 25°C

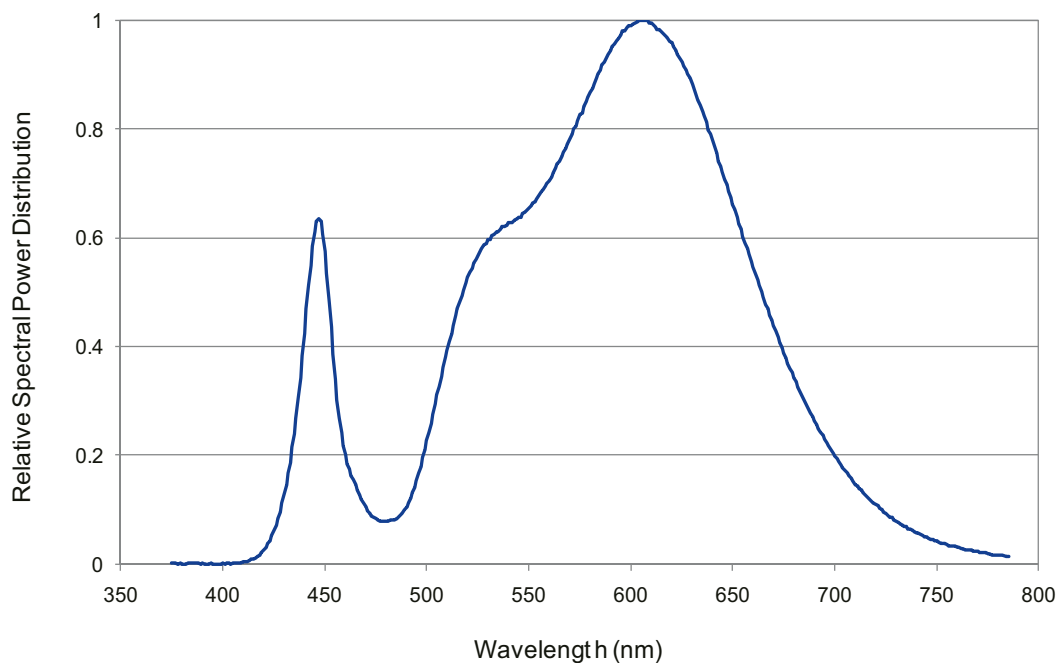

Figure 8. Color spectrum of LXM8-PW30 emitter, integrated measurement.

LXM3-PW61 (3500K) at Test Current, Thermal Pad Temperature = 25°C

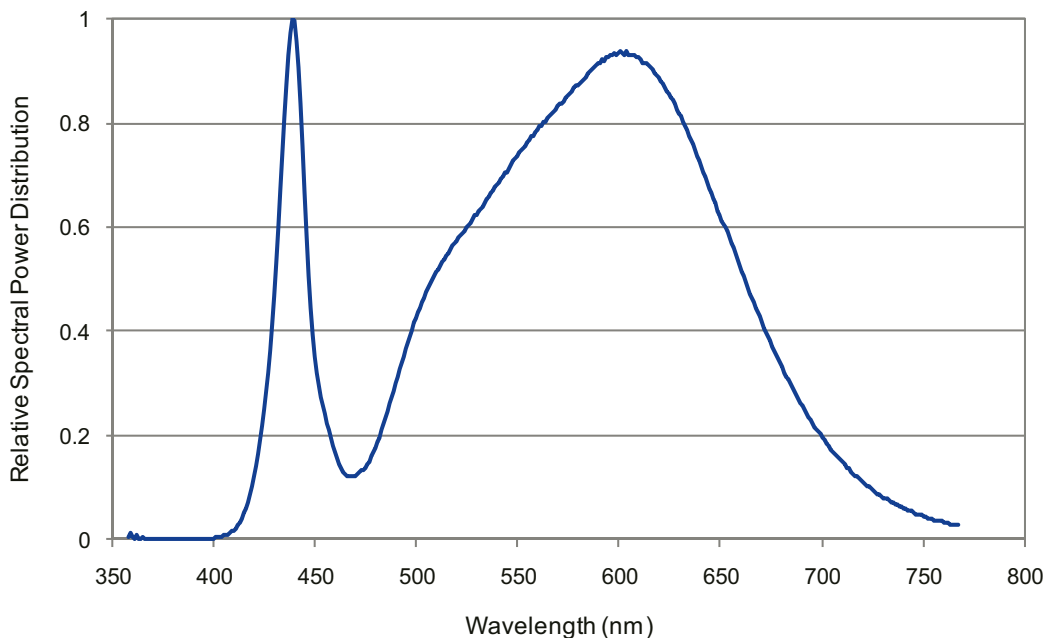

Figure 9. Color spectrum of LXM3-PW61 emitter, integrated measurement.

# Relative Spectral Distribution vs. Wavelength Characteristics, Continued

LXM3-PW51 (4000K) at Test Current, Thermal Pad Temperature = 25°C

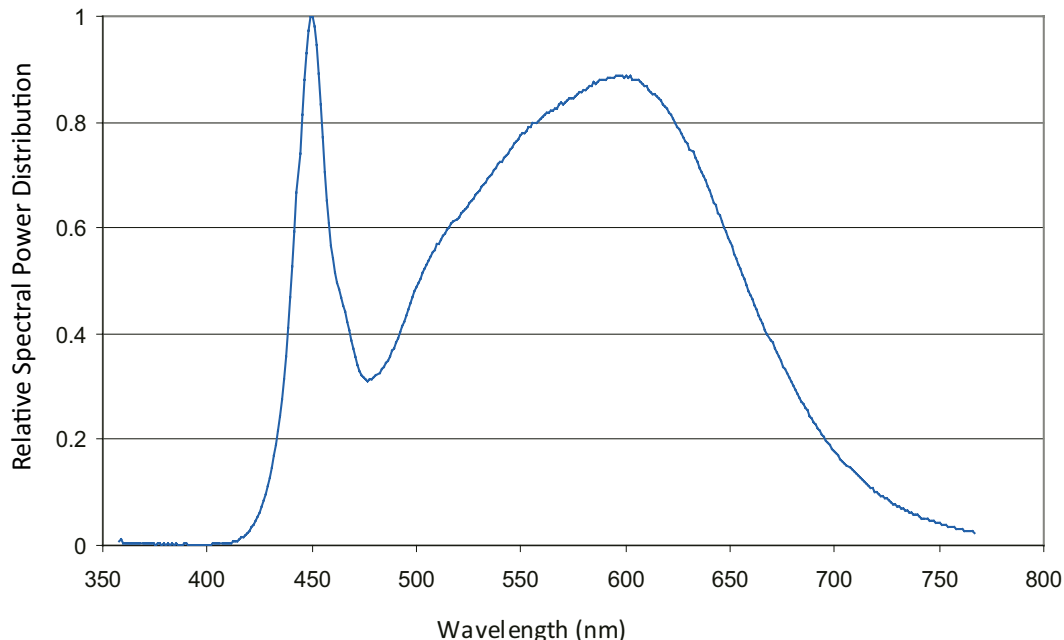

Figure 10. Color spectrum of LXM3-PW51 emitter, integrated measurement.

LXML-PW51 (4000K) at Test Current, Thermal Pad Temperature = 25°C

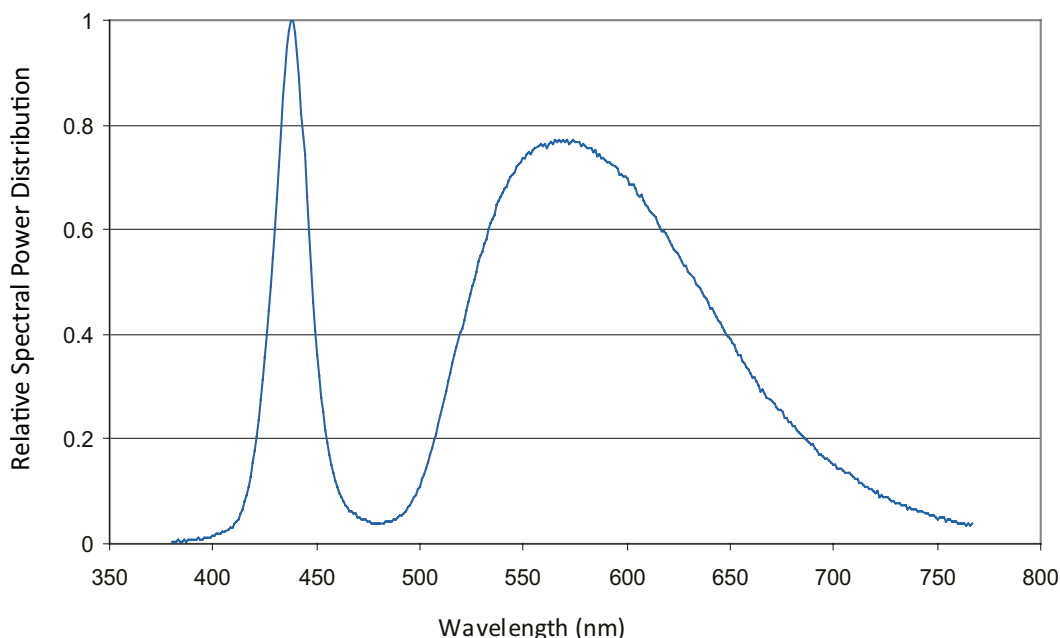

Figure 11. Color spectrum of LXML-PW51 emitter, integrated measurement.

# Relative Spectral Distribution vs. Wavelength Characteristics, Continued

LXML-PW3 I (5000K), LXML-PW2 I (5700K) and LXML-PW1 I (6500K)  
at Test Current, Thermal Pad Temperature = 25°C

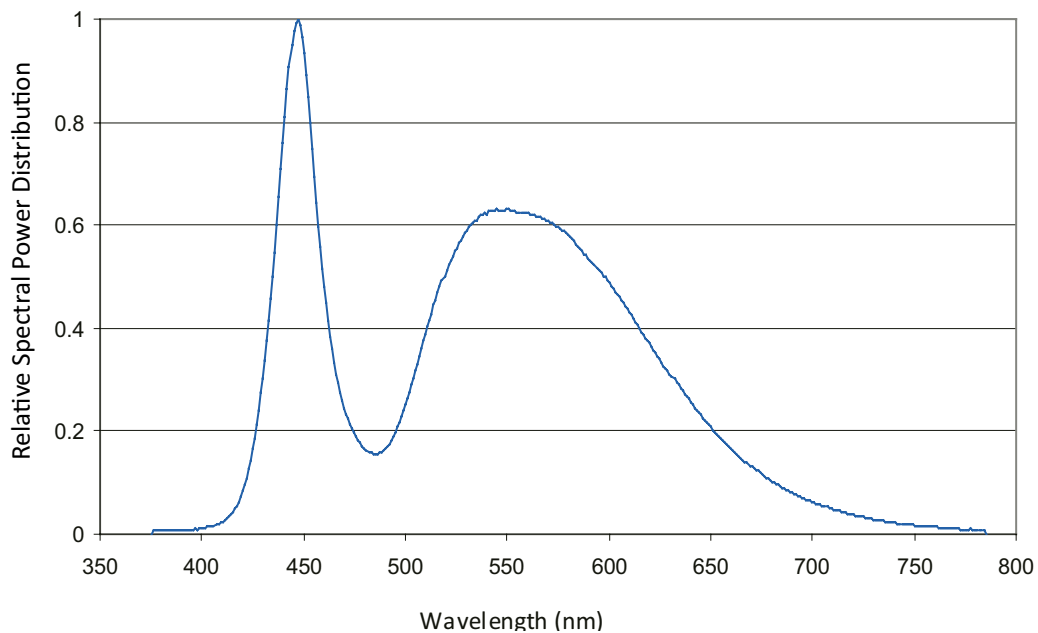

Figure 12. Color spectrum of LXML-PW3 I, LXML-PW2 I and LXML-PW1 I emitters, integrated measurement.



# Light Output Characteristics over Temperature

## All Parts Except LXML-PW5I at Test Current

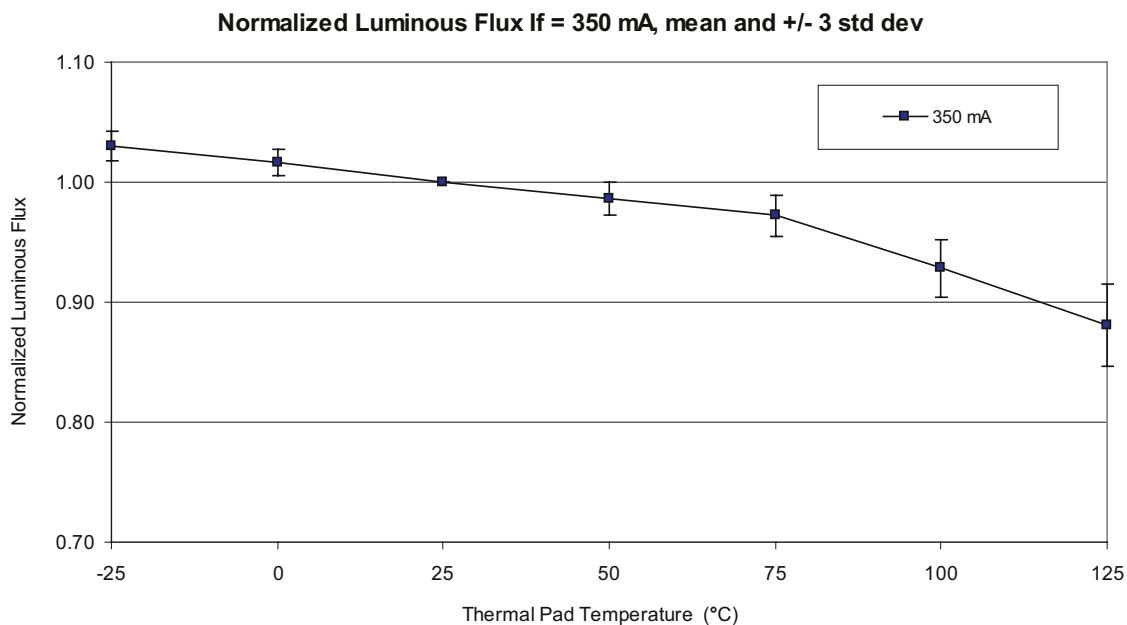

Figure 13. Relative light output vs. thermal pad temperature.

## LXML-PW5I at Test Current

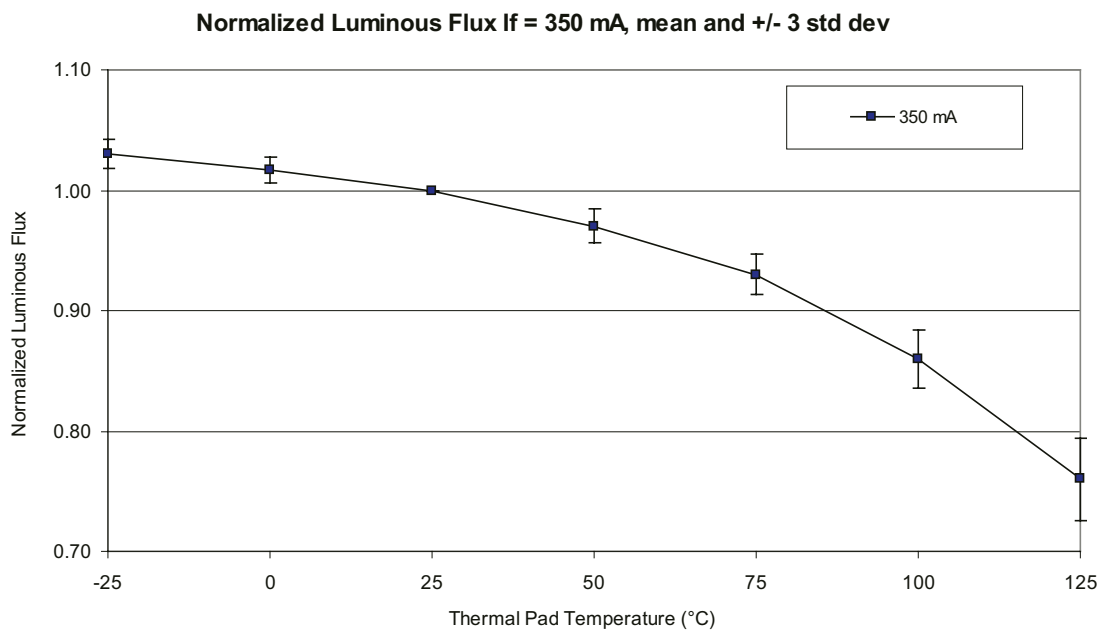

Figure 14. Relative light output vs. thermal pad temperature.

# Light Output Characteristics over Temperature, Continued

## Typical Efficacy vs. Junction Temperature

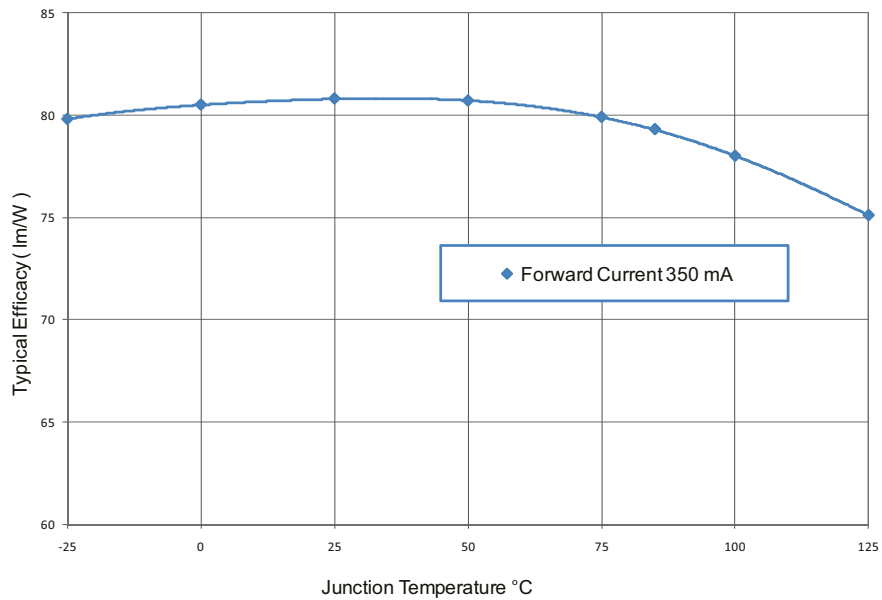

Figure 15. LXM8-PW27 and LXM8-PW30 emitters efficacy versus junction temperature.

# Typical Forward Current Characteristics

## Typical Forward Current Characteristics Thermal Pad Temperature = 25°C

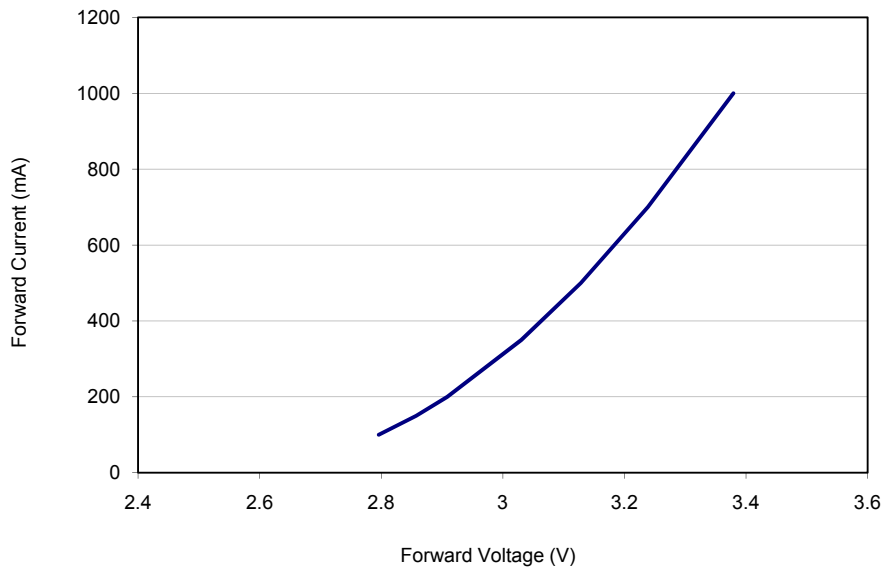

Figure 16. Forward current vs. forward voltage.

## Typical Relative Luminous Flux vs. Forward Current Thermal Pad Temperature = 25°C

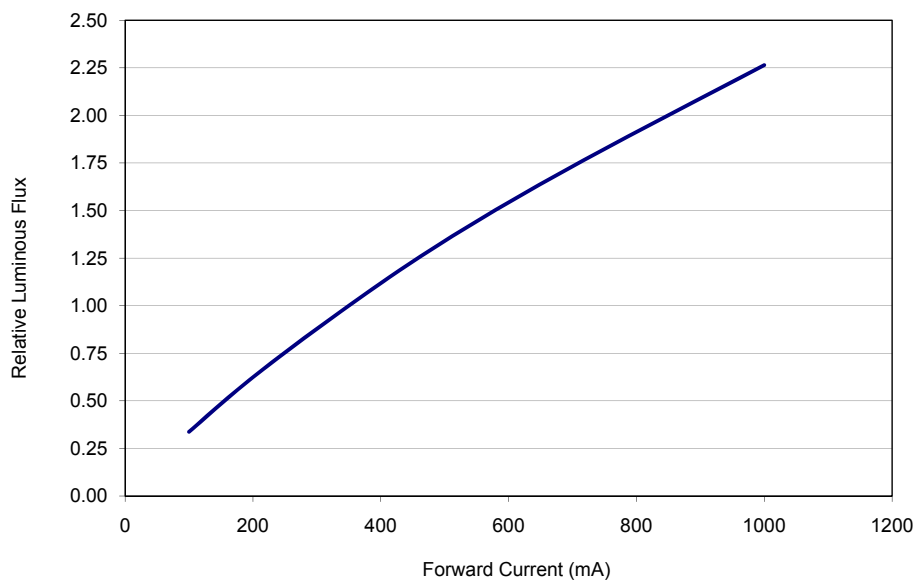

Figure 17. Typical relative luminous flux vs. forward current, thermal pad temperature = 25°C.

# Current Derating Curves

## Current Derating Curve for 350 mA Drive Current

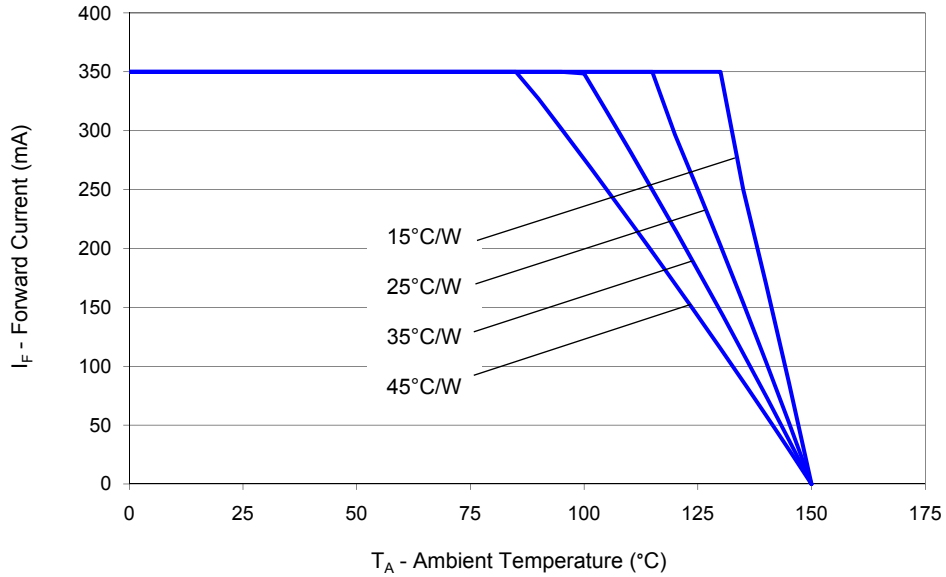

Figure 18. Maximum forward current vs. ambient temperature, based on  $T_{JMAX} = 150^{\circ}C$ .

## Current Derating Curve for 700 mA Drive Current

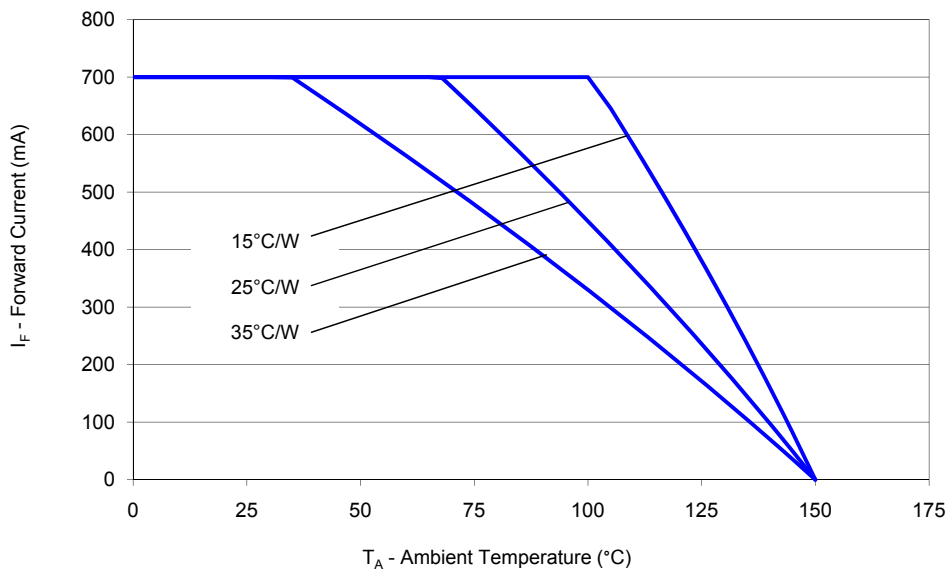

Figure 19. Maximum forward current vs. ambient temperature, based on  $T_{JMAX} = 150^{\circ}C$ .

# Typical Radiation Patterns

## Typical Spatial Radiation Pattern for Lambertian

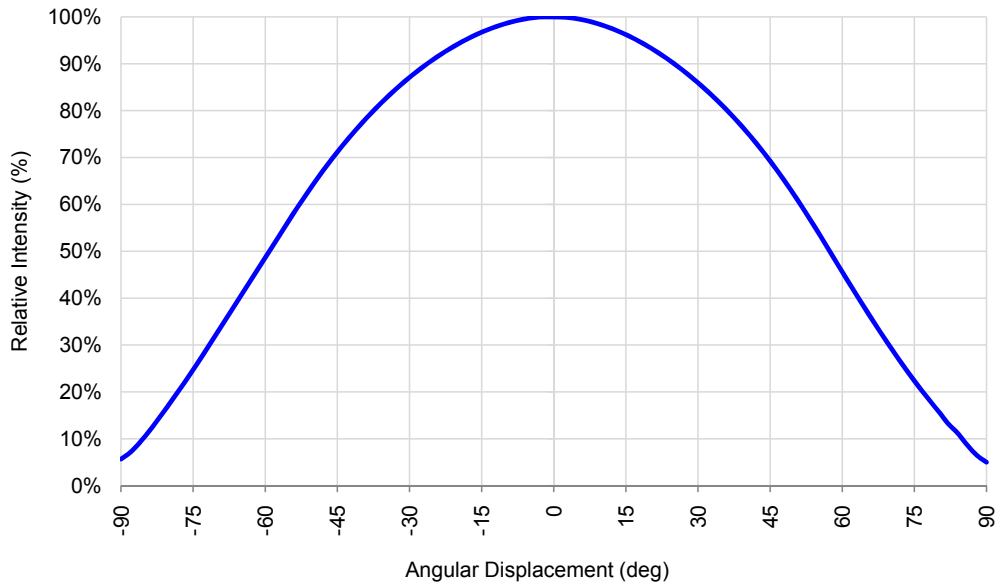

Figure 20. Typical representative spatial radiation pattern for lambertian.

## Typical Polar Radiation Pattern for Lambertian

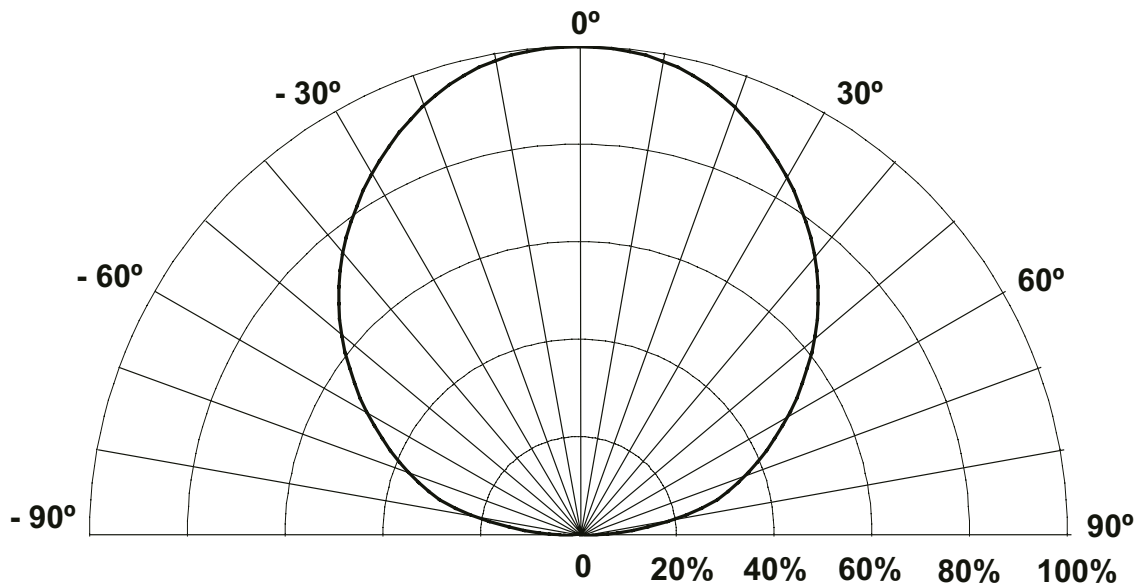

Figure 21. Typical polar radiation pattern for lambertian.

# Typical Radiation Patterns, Continued

## Typical Color vs. Viewing Angle

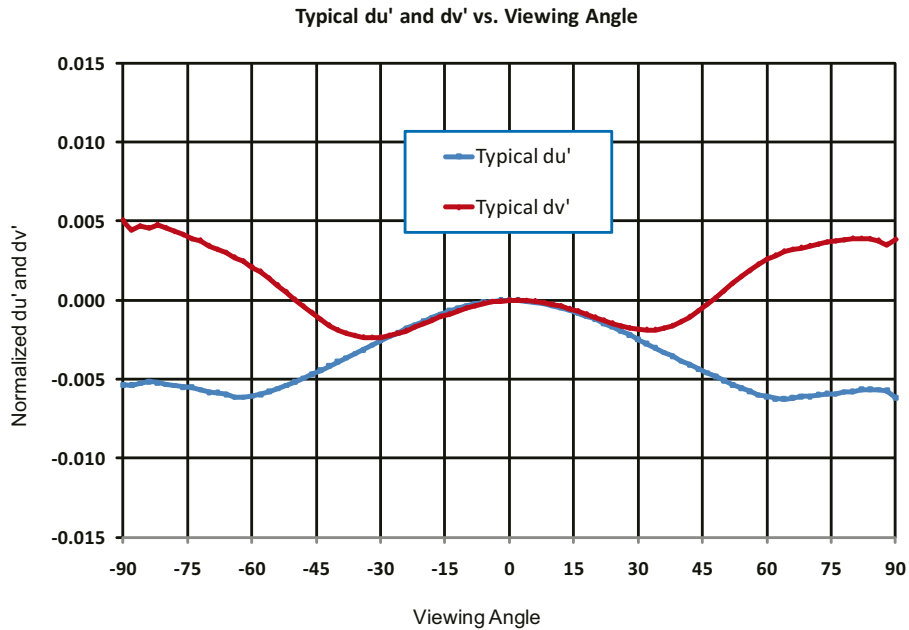

Figure 22. Applicable for LXM8-PW27 and LXM8-PW30 emitters.

## Typical $du'$ and $dv'$ Color Variation vs. Viewing Angle

Typical  $du'$  versus  $dv'$  characteristic versus angle (0 to 90 degrees) for LXM8 series.  
Maximum  $du'$ / $dv'$  deviation within rectangular mask ( $u'$  0 to -0.01,  $v'$  -0.005 to 0.01)  
Normalized to 0 degrees (on axis) at 0,0

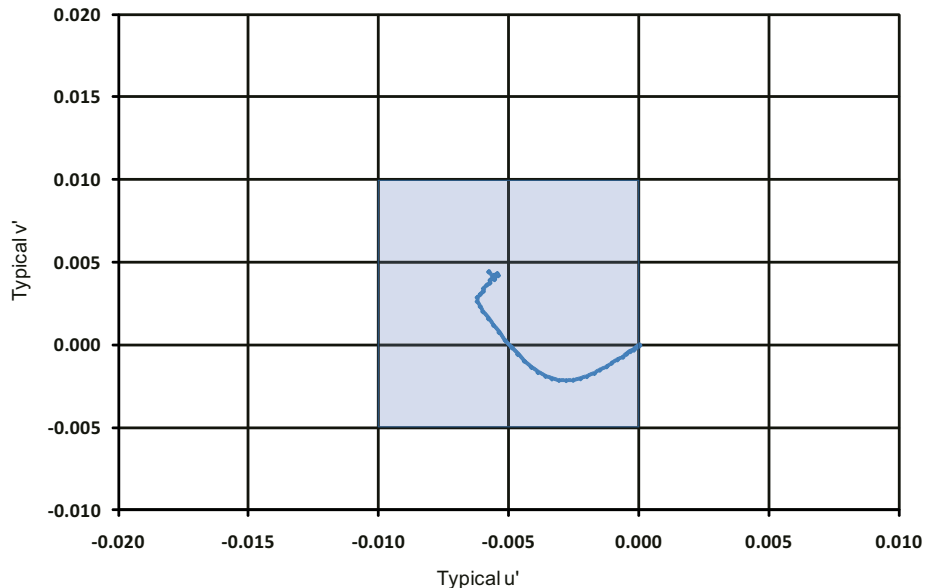

Figure 23. Applicable for LXM8-PW27 and LXM8-PW30 emitters.

# Emitter Pocket Tape Packaging

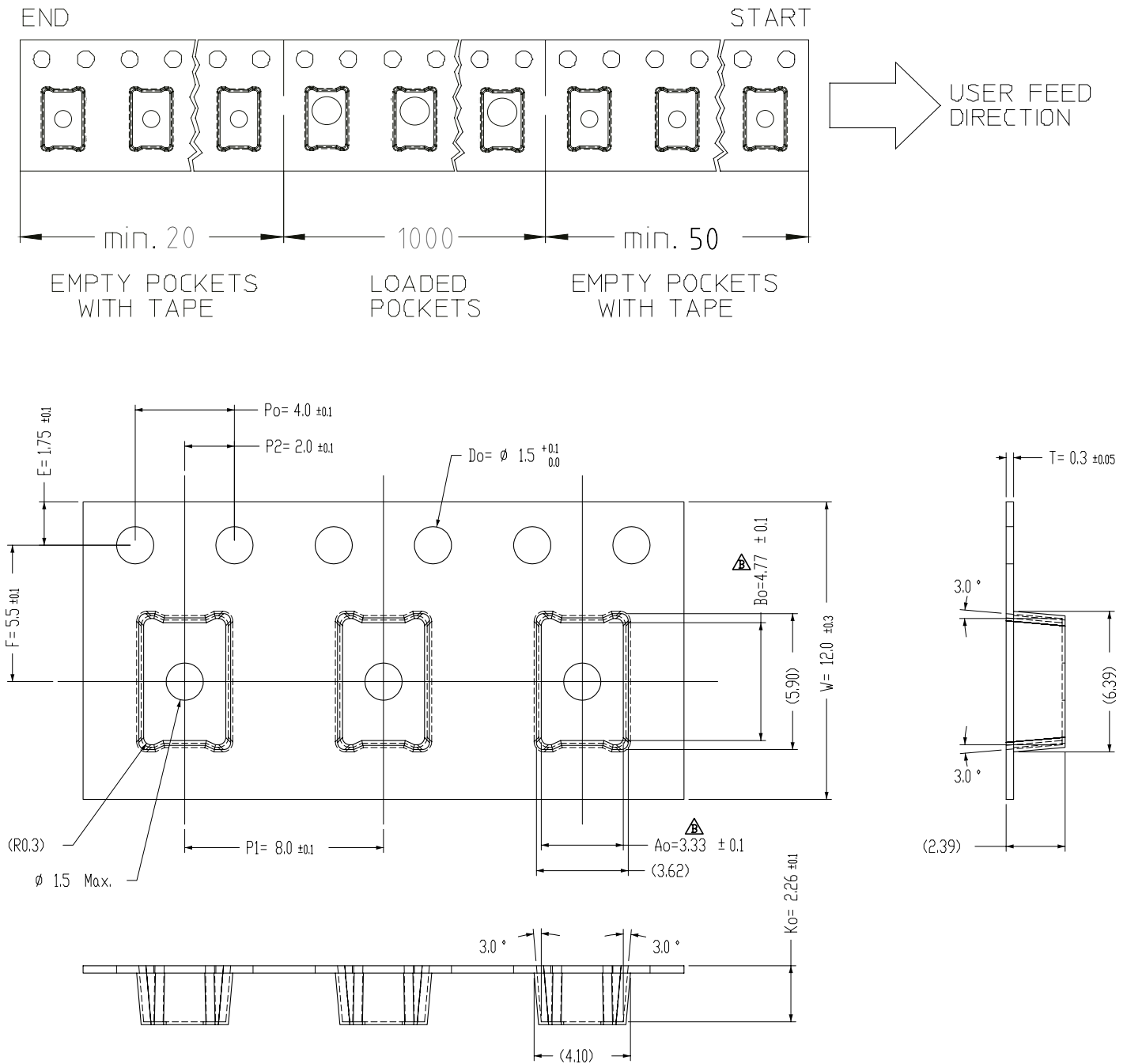
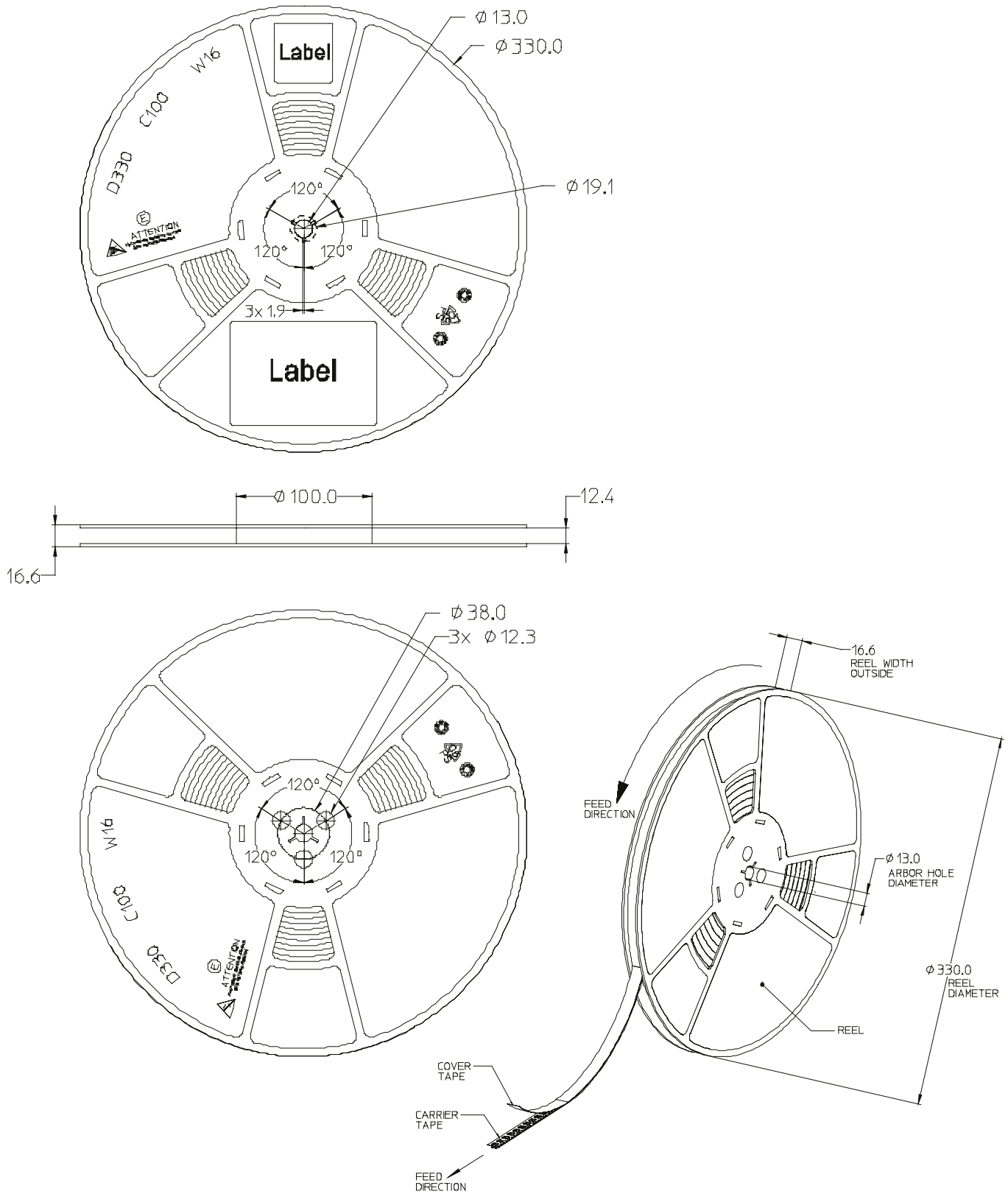

Figure 24. Emitter pocket tape packaging.

# Emitter Reel Packaging



**Figure 25. Emitter reel packaging.**



# Product Binning and Labeling

## Purpose of Product Binning

In the manufacturing of semiconductor products, there is a variation of performance around the average values given in the technical data sheets. For this reason, Philips Lumileds bins the LED components for luminous flux, color and forward voltage ( $V_f$ ).

## Decoding Product Bin Labeling

LUXEON Rebel Emitters are labeled using a four digit alphanumeric code (CAT code) depicting the bin values for emitters packaged on a single reel. All emitters packaged within a reel are of the same 3-variable bin combination. Using these codes, it is possible to determine optimum mixing and matching of products for consistency in a given application.

Reels of 2700K, 3000K, 3500K, 4000K, 5000K, 5700K, 6500K Emitters are labeled with a four digit alphanumeric CAT code following the format below.

ABCD

A = Flux bin (J, K, L, M etc.)

B and C = Color bin (For example 5A, 5B, 5C are ANSI quadrant color bins for LXML and LXM3 series, and 8E, 8F, 8G are ANSI 1/16th micro color bins for the LXM8 series.)

D =  $V_f$  bin (Where C, D, E are for LXML and LXM3 series 0.24V forward voltage bins, and P, R, S are for LXM8 series 0.25V forward voltage bins.)

## Luminous Flux Bins

Table 8 lists the standard photometric luminous flux bins for LUXEON Rebel emitters (tested and binned at 350 mA).

Although several bins are outlined, product availability in a particular bin varies by production run and by product performance. Not all bins are available in all colors.

**Table 8.**  
Flux Bins - All Colors

Bin Code	Minimum Photometric Flux (lm)	Maximum Photometric Flux (lm)
H	50	60
J	60*	70
K	70**	80
L	80	90
M	90	100
N	100	120
P	120	140
Q	140	160
R	160	180
S	180	200

\* 65 lm for LXM3-PW81, 66 lm for LXM3-PW71, 67 lm for LXM3-PW61

\*\* 75 lm for LXM8-PW30 and LXM3-PW51

# LUXEON Rebel ANSI I/I 6<sup>th</sup> Micro Bin Structure

## ANSI I/I 6<sup>th</sup> micro bin structure for LXM8-PW27 and LXM8-PW30 emitters

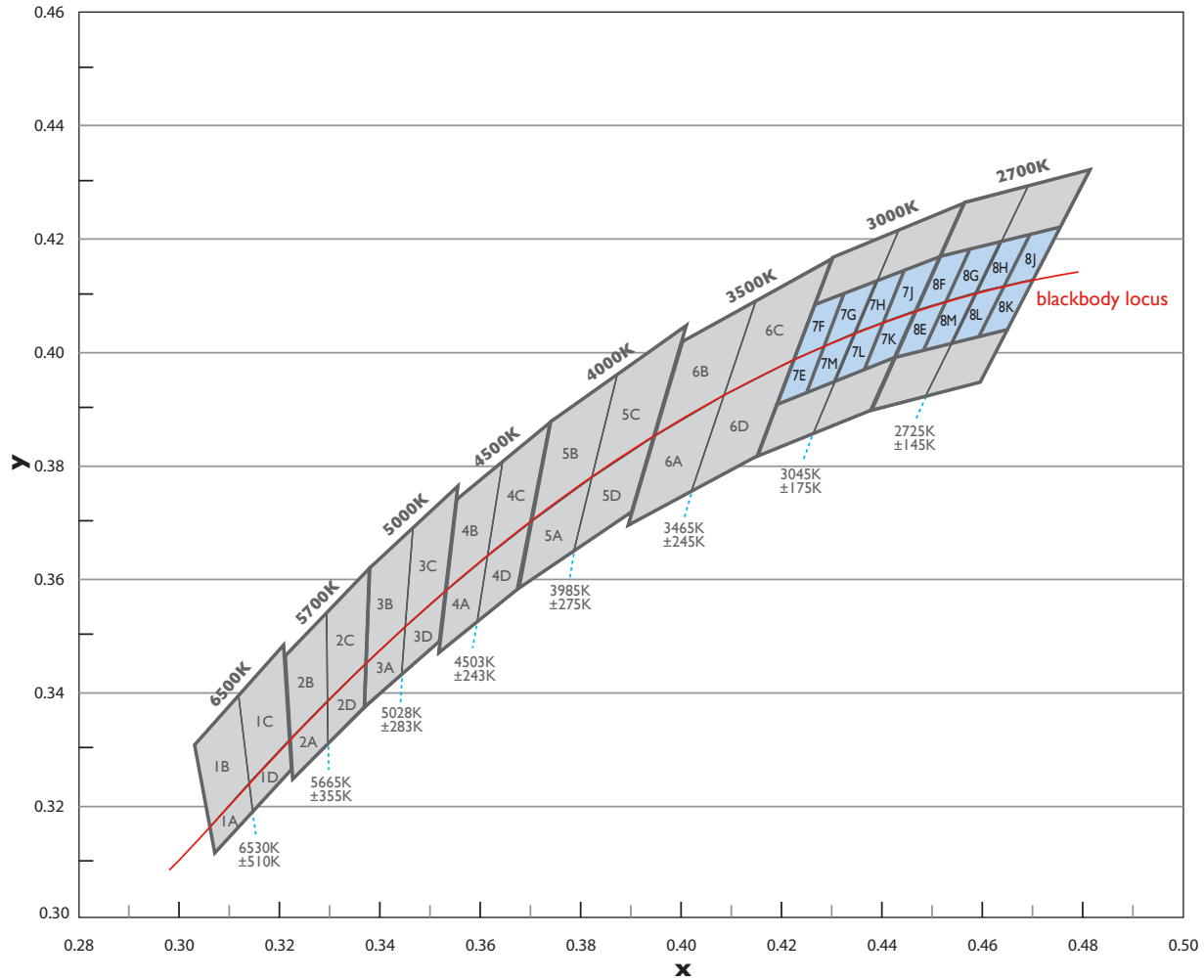

Figure 26. LUXEON Rebel ANSI I/I 6<sup>th</sup> micro bin structure.

# LUXEON Rebel ANSI I/4<sup>th</sup> Quadrant Bin Structure

ANSI I/4th quadrant bin structure for LXM3-PW8I, LXM3-PW7I, LXML-PW7I, LXM3-PW6I, LXM3-PW5I, LXML-PW5I, LXML-PW3I, LXML-PW2I and LXML-PW1I emitters

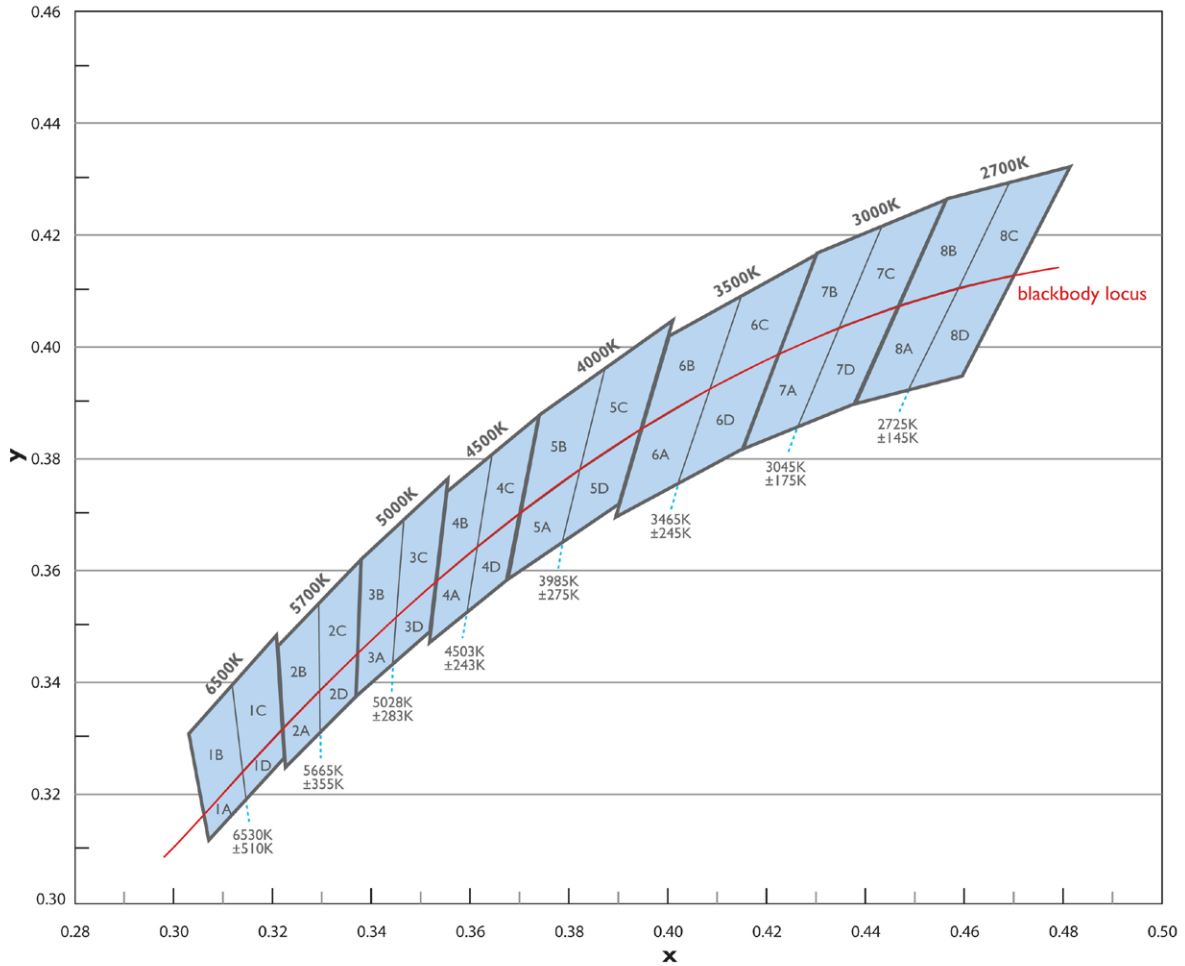

Figure 27. LUXEON Rebel ANSI I/4th quadrant bin structure.

# LUXEON Rebel ANSI I/I 6<sup>th</sup> Micro Bin Coordinates

**Table 9.**

LUXEON Rebel ANSI I/I 6 <sup>th</sup> Micro Bin Structure Coordinates							
Nominal CCT	Bin Code	x	y	Nominal CCT	Bin Code	x	y
2700K	8E	0.446470	0.407117	3000K	7E	0.422300	0.398950
		0.452542	0.408716			0.428413	0.401125
		0.447668	0.399645			0.424381	0.392250
		0.441885	0.398209			0.418500	0.390175
	8F	0.451335	0.416559		7F	0.426100	0.407725
		0.457504	0.418094			0.432444	0.410000
		0.452542	0.408716			0.428413	0.401125
		0.446470	0.407117			0.422300	0.398950
	8G	0.457504	0.418094		7G	0.432444	0.410000
		0.463673	0.419630			0.438788	0.412275
		0.458614	0.410315			0.434525	0.403300
		0.452542	0.408716			0.428413	0.401125
	8H	0.463673	0.419630		7H	0.438788	0.412275
		0.469650	0.420941			0.445131	0.414550
		0.464284	0.411458			0.440638	0.405475
		0.458614	0.410315			0.434525	0.403300
	8j	0.469650	0.420941		7j	0.445131	0.414550
		0.475627	0.422251			0.451475	0.416825
		0.469954	0.412602			0.446750	0.407650
		0.464284	0.411458			0.440638	0.405475
	8K	0.464284	0.411458		7K	0.440638	0.405475
		0.469954	0.412602			0.446750	0.407650
		0.464627	0.403501			0.442025	0.398475
		0.459039	0.402291			0.436144	0.396400
8L	0.458614	0.410315	7L	0.434525	0.403300		
	0.464284	0.411458		0.440638	0.405475		
	0.459039	0.402291		0.436144	0.396400		
	0.453450	0.401081		0.430263	0.394325		
8M	0.452542	0.408716	7M	0.428413	0.401125		
	0.458614	0.410315		0.434525	0.403300		
	0.453450	0.401081		0.430263	0.394325		
	0.447668	0.399645		0.424381	0.392250		

**Notes for Table 9:**

1. Philips Lumileds maintains a tester tolerance of  $\pm 0.005$  on x, y color coordinates.
2. Applicable for LXM8-PW27 and LXM8-PW30 emitters.

# LUXEON Rebel ANSI 1/4<sup>th</sup> Quadrant Bin Coordinates

LUXEON Rebel Emitters are tested and binned by x,y coordinates.

32 Color Bins, CCT Range 2580K to 7040K

**Table 10.**

LUXEON Rebel ANSI 1/4th quadrant Bin Coordinates							
Nominal CCT	Bin Code	x	y	Nominal CCT	Bin Code	x	y
2700K	8A	0.458614	0.410315	3500K	6A	0.408216	0.392153
		0.446470	0.407117			0.394131	0.384815
		0.437300	0.389300			0.388900	0.369000
		0.448286	0.391847			0.401706	0.375155
	8B	0.468732	0.428946		6B	0.414622	0.408937
		0.456200	0.426000			0.399600	0.401500
		0.446470	0.407117			0.394131	0.384815
		0.458614	0.410315			0.408216	0.392153
	8C	0.481300	0.431900		6C	0.429900	0.416500
		0.468732	0.428946			0.414622	0.408937
		0.458614	0.410315			0.408216	0.392153
		0.469954	0.412602			0.422071	0.398417
	8D	0.469954	0.412602		6D	0.422071	0.398417
		0.458614	0.410315			0.408216	0.392153
		0.448286	0.391847			0.401706	0.375155
		0.459300	0.394400			0.414700	0.381400
3000K	7A	0.434392	0.403186	4000K	5A	0.381883	0.377641
		0.422071	0.398417			0.369655	0.369740
		0.414700	0.381400			0.367000	0.357800
		0.425959	0.385336			0.378297	0.364637
	7B	0.442994	0.421230		5B	0.386955	0.395809
		0.429900	0.416500			0.373600	0.387400
		0.422071	0.398417			0.369655	0.369740
		0.434392	0.403186			0.381883	0.377641
	7C	0.456200	0.426000		5C	0.400600	0.404400
		0.442994	0.421230			0.386955	0.395809
		0.434392	0.403186			0.381883	0.377641
		0.446470	0.407117			0.394131	0.384815
	7D	0.446470	0.407117		5D	0.394131	0.384815
		0.434392	0.403186			0.381883	0.377641
		0.425959	0.385336			0.378297	0.364637
		0.437300	0.389300			0.389800	0.371600

# LUXEON Rebel ANSI 1/4<sup>th</sup> Quadrant Bin Coordinates, Continued

**Table 10, Continued.**

LUXEON Rebel ANSI 1/4 <sup>th</sup> Quadrant Bin Coordinates							
Nominal CCT	Bin Code	x	y	Nominal CCT	Bin Code	x	y
4500K	4A	0.361112	0.363778	5700K	2A	0.329231	0.338226
		0.352638	0.357500			0.321708	0.331406
		0.351200	0.346500			0.322200	0.324300
		0.359037	0.352105			0.329330	0.330539
	4B	0.364112	0.380435		2B	0.329053	0.353812
		0.354800	0.373600			0.320700	0.346200
		0.352638	0.357500			0.321708	0.331406
		0.361112	0.363778			0.329231	0.338226
	4C	0.373600	0.387400		2C	0.337600	0.361600
		0.364112	0.380435			0.329053	0.353812
		0.361112	0.363778			0.329231	0.338226
		0.369655	0.369740			0.336916	0.344873
	4D	0.369655	0.369740		2D	0.336916	0.344873
		0.361112	0.363778			0.329231	0.338226
		0.359037	0.352105			0.329330	0.330539
		0.367000	0.357800			0.336600	0.336900
5000K	3A	0.344719	0.351301	6500K	1A	0.313640	0.323739
		0.336916	0.344873			0.305852	0.315982
		0.336600	0.336900			0.306800	0.311300
		0.343985	0.342749			0.314359	0.318612
	3B	0.346260	0.368726		1B	0.311529	0.339129
		0.337600	0.361600			0.302800	0.330400
		0.336916	0.344873			0.305852	0.315982
		0.344719	0.351301			0.313640	0.323739
	3C	0.355100	0.376000		1C	0.320500	0.348100
		0.346260	0.368726			0.311529	0.339129
		0.344719	0.351301			0.313640	0.323739
		0.352638	0.357500			0.321708	0.331406
	3D	0.352638	0.357500		1D	0.321708	0.331406
		0.344719	0.351301			0.313640	0.323739
		0.343985	0.342749			0.314359	0.318612
		0.351500	0.348700			0.322100	0.326100

**Notes for Table 10:**

1. Philips Lumileds maintains a tester tolerance of  $\pm 0.005$  on x, y color coordinates.
2. Applicable for LXM3-PW81, LXM3-PW71, LXML-PW71, LXM3-PW61, LXM3-PW51, LXML-PW51, LXML-PW31, LXML-PW21 and LXML-PW11 emitters.

# Forward Voltage Bins

Tables 11 and 12 list minimum and maximum  $V_f$  bin values per emitter. Although several bins are outlined, product availability in a particular bin varies by production run and by product performance.

**Table 11.**

$V_f$ Bins		
Bin Code	Minimum Forward Voltage (V)	Maximum Forward Voltage (V)
B	2.55	2.79
C	2.79	3.03
D	3.03	3.27
E	3.27	3.51
F	3.51	3.75
G	3.75	3.99

Note for Table 11:

1. Applicable for LXM3-PW81, LXM3-PW71, LXML-PW71, LXM3-PW61, LXM3-PW51, LXML-PW51, LXML-PW31, LXML-PW21 and LXML-PW11 emitters.

**Table 12.**

$V_f$ Bins		
Bin Code	Minimum Forward Voltage (V)	Maximum Forward Voltage (V)
P	2.50	2.75
R	2.75	3.00
S	3.00	3.25
T	3.25	3.50

Note for Table 12:

1. Applicable for LXM8-PW27 and LXM8-PW30 emitters.

# Company Information

Philips Lumileds is the world's leading provider of power LEDs for everyday lighting applications. The company's records for light output, efficacy and thermal management are direct results of the ongoing commitment to advancing solid-state lighting technology and enabling lighting solutions that are more environmentally friendly, help reduce CO<sub>2</sub> emissions and reduce the need for power plant expansion. Philips Lumileds LUXEON® LEDs are enabling never before possible applications in outdoor lighting, shop lighting and home lighting.

Philips Lumileds is a fully integrated supplier, producing core LED material in all three base colors, (Red, Green, Blue) and white. Philips Lumileds has R&D centers in San Jose, California and in the Netherlands, and production capabilities in San Jose, Singapore and Penang Malaysia. Founded in 1999, Philips Lumileds is the high flux LED technology leader and is dedicated to bridging the gap between solid-state technology and the lighting world. More information about the company's LUXEON LED products and solid-state lighting technologies can be found at [www.philipslumileds.com](http://www.philipslumileds.com).

[www.philipslumileds.com](http://www.philipslumileds.com)  
[www.futurelightingsolutions.com](http://www.futurelightingsolutions.com)

For technical assistance or the location of your nearest sales office contact any of the following:

North America:  
1 888 589 3662  
[americas@futurelightingsolutions.com](mailto:americas@futurelightingsolutions.com)

Europe:  
00 800 443 88 873  
[europe@futurelightingsolutions.com](mailto:europe@futurelightingsolutions.com)

Asia Pacific:  
800 5864 5337  
[asia@futurelightingsolutions.com](mailto:asia@futurelightingsolutions.com)

Japan:  
800 5864 5337  
[japan@futurelightingsolutions.com](mailto:japan@futurelightingsolutions.com)

©2010 Philips Lumileds Lighting Company. All rights reserved.  
Product specifications are subject to change without notice.  
LUXEON is a registered trademark of the Philips Lumileds Lighting Company in the United States and other countries.

**PHILIPS**  
**LUMILEDS**